

# B\_SUITE

HIGHLY TECHNOLOGICAL,  
ADVANCED SOFTWARE SOLUTIONS



A large, dark grey, stylized letter 'S' is the central focus of the page. It is surrounded by a network of thin white lines and small square nodes, some of which are connected to the 'S' and others to the side logos.



# A SINGLE, INTEGRATED SOFTWARE SOLUTION



A single platform to manage all machine processes.

**B\_SOLID**



**B\_EDGE**



**B\_NEST**



## THE MARKET REQUIRES

**user-friendly software solutions** for woodworking and advanced material processing machines that can be used by all operators without the need for special IT skills.

## BIESSE MEETS

these requirements by developing **software solutions** around our customers' day-to-day operations, with user-friendly and intuitive interfaces. **B\_SUITE** is a complete suite of advanced software tools, giving users access to cutting edge technology. If software is the only limitation to a machine's capabilities, then bSuite offers endless possibilities.

### 'B\_WINDOWS



### 'B\_DOORS



# HIGH-TECH BECOMES ACCESSIBLE AND INTUITIVE



**B\_SOLID IS A 3D CAD CAM SOFTWARE PROGRAM THAT SUPPORTS THE PERFORMANCE OF ANY MACHINING OPERATION THANKS TO VERTICAL MODULES DESIGNED FOR SPECIFIC MANUFACTURING PROCESSES.**

- Planning in just a few clicks.
- Simulating machining operations to visualise the piece ahead of manufacturing and have some guidance for the planning phase.
- Virtual prototyping of the piece to avoid collisions and ensure optimal machine equipment.
- Machining operation simulation with a calculation of the execution time.



B\_SOLID

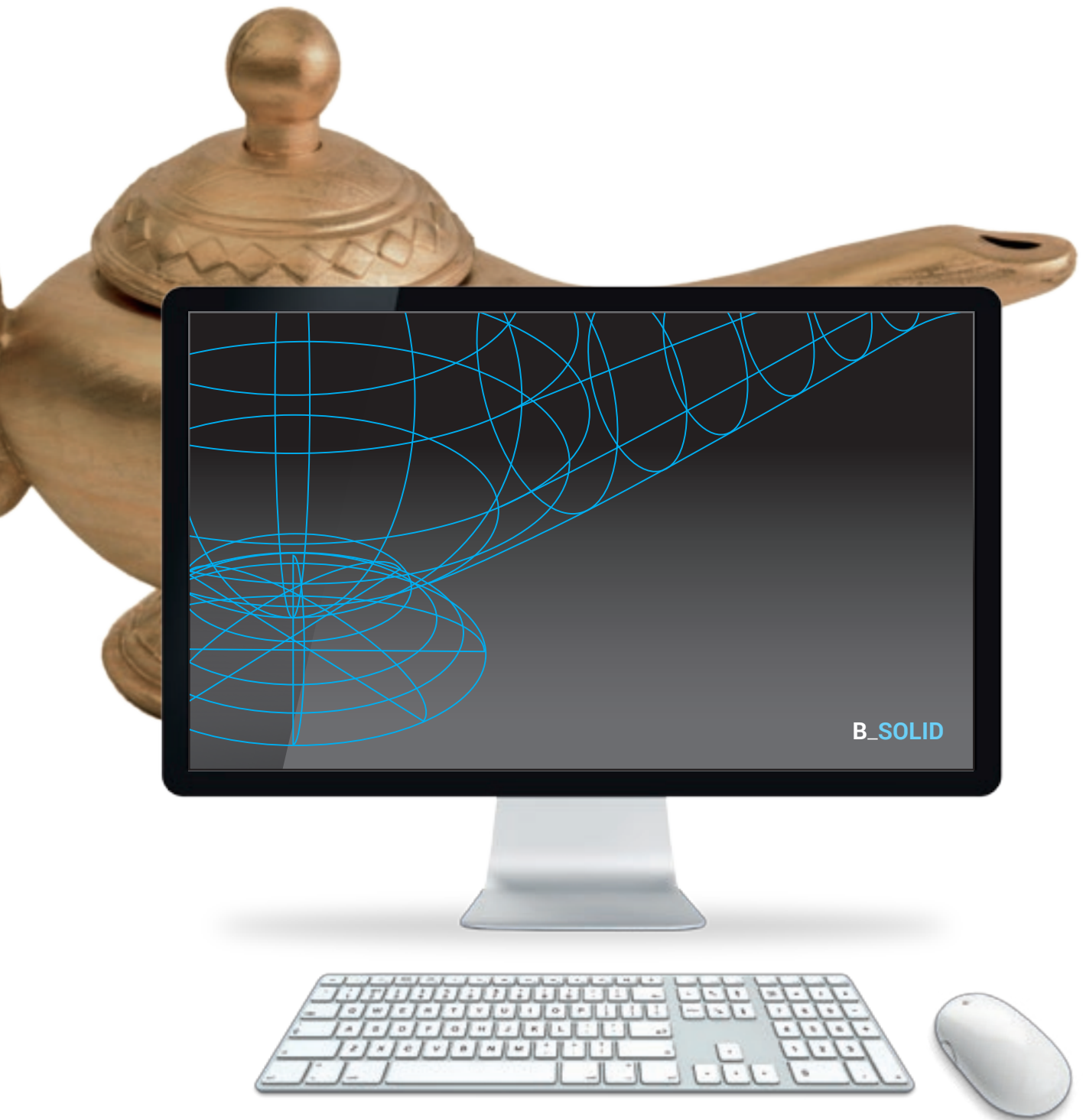

# PLANNING IN JUST A FEW CLICKS

Importing or drawing any type of project (2D and 3D),  
from the easiest to the most complex, thanks to a unique  
design system.



Thanks to the integration of a new learning system, the software enables users to access sophisticated functionalities. The user only needs to set the dimensions and then - with a simple click - can visualise the product to be processed on a screen, together with all the operations needed to manufacture it.

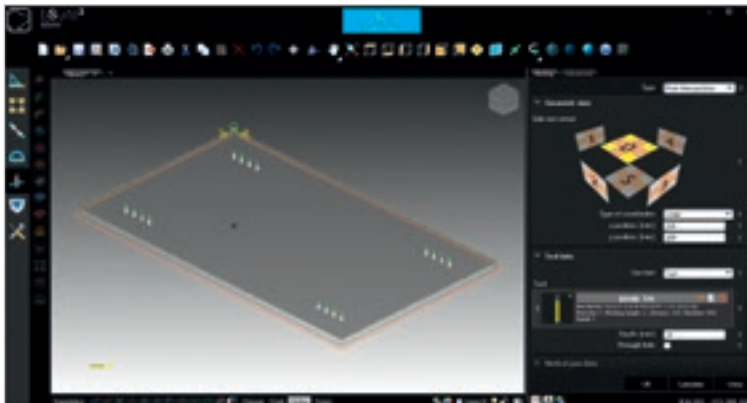

Parametric software  
Adapts automatically to the various  
piece dimensions.

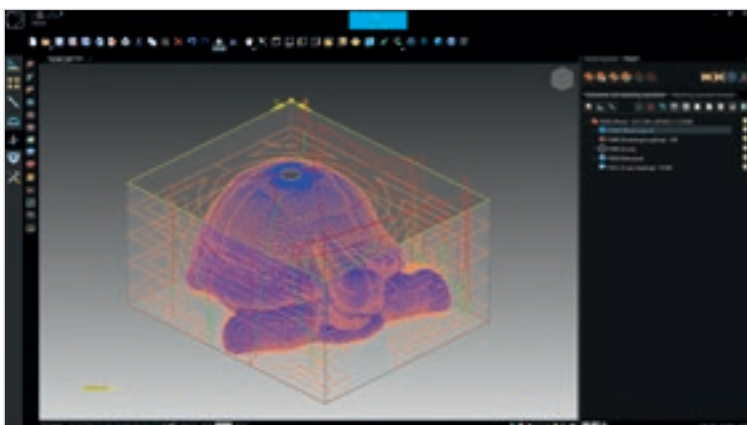

Machining of complex 3D shapes  
with user-friendly functions.

# SIMULATING MACHINING OPERATIONS TO VISUALISE THE COMPONENT PRIOR TO MANUFACTURING

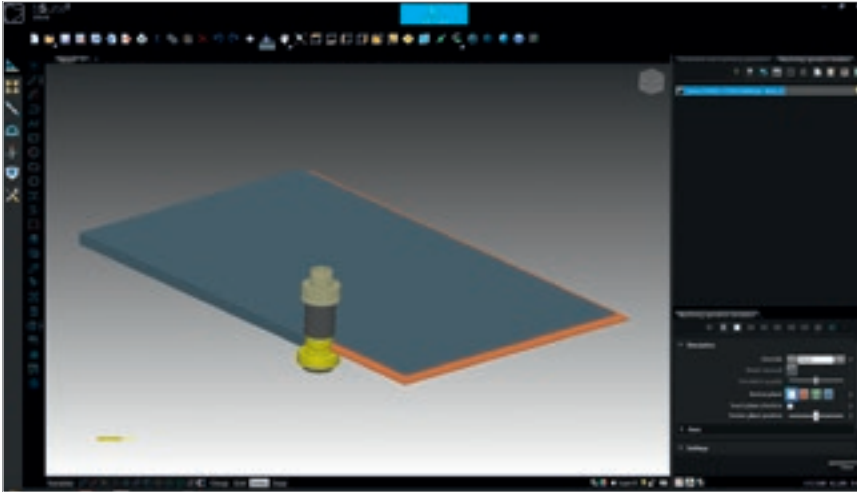

B\_SOLID enables the user to verify the project through rapid and effective 3D simulation that supports:

- ▣ verification of the accuracy of the tool path;
- ▣ immediate, intuitive check of the machining operations and the effect of the tools on the piece;
- ▣ modifying and checking the project before machining.

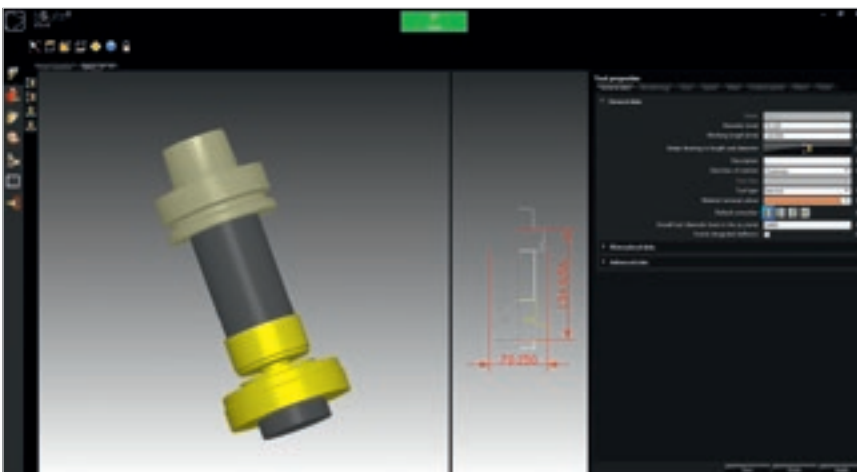

The tool management module offers the possibility to create and modify milling cutters, blades and boring bits to suit the customer's needs.

# VIRTUAL PROTOTYPING OF THE COMPONENT

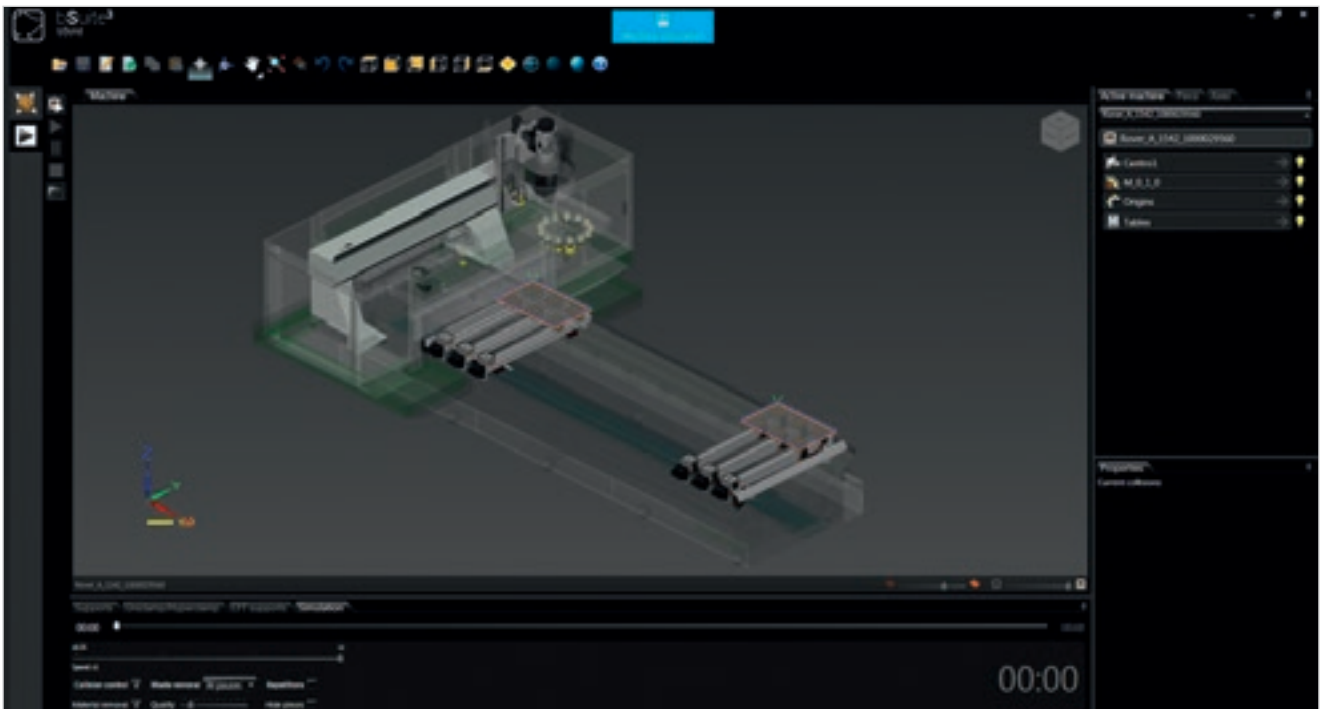

B\_SOLID makes the customer's machine available in a virtual environment, complete with its components and the NC axis movement kinematics.



Thanks to the collision check, any interference between machine parts can be verified directly from the office, so potential errors can be prevented or corrected



# CALCULATION OF THE TIME NEEDED TO CARRY OUT ALL THE MACHINING OPERATIONS

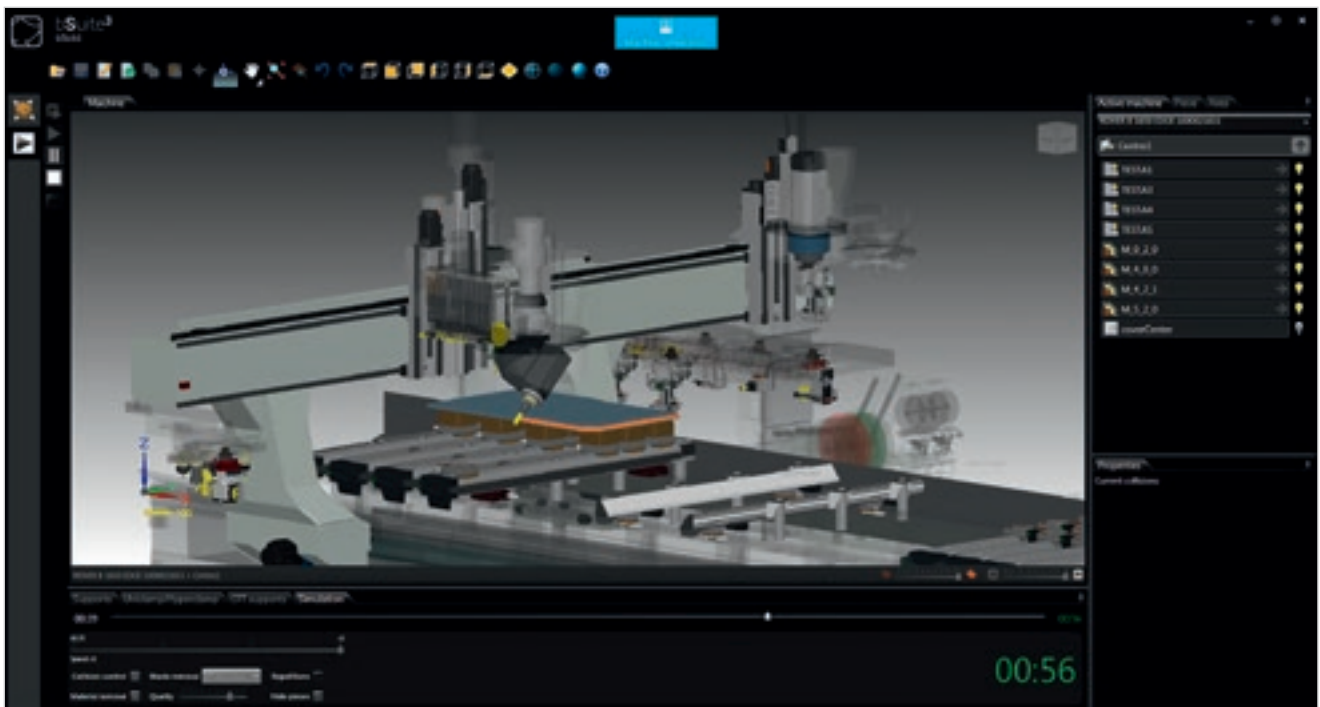

Simulation is not only handy when it comes to checking or preventing collisions; it also enables a calculation of the time needed to carry out all the machining operations, thereby facilitating the factory logistics system.



The tool magazine and spindles can be tooled with a simple drag and drop.

# SIMPLIFYING EDGEBANDING PROGRAMMING



**B\_EDGE IS AN ADDITIONAL MODULE INTEGRATED IN B\_SUITE. MAKING FULL USE OF THE CAPACITIES OF THE SUITE, B\_EDGE SIMPLIFIES THE PROGRAMMING OF THE EDGEBANDING PROCESS.**

- Automatic generation of the edgbanding operation sequence.
- Easy to understand and operate.
- Simplified management of edgbanding strips and edgbanding devices

B\_EDGE



# AUTOMATIC EDGEBANDING OPERATION SEQUENCE

B\_EDGE reduces design times, allowing the edgeworking operation to be programmed in just a few steps.

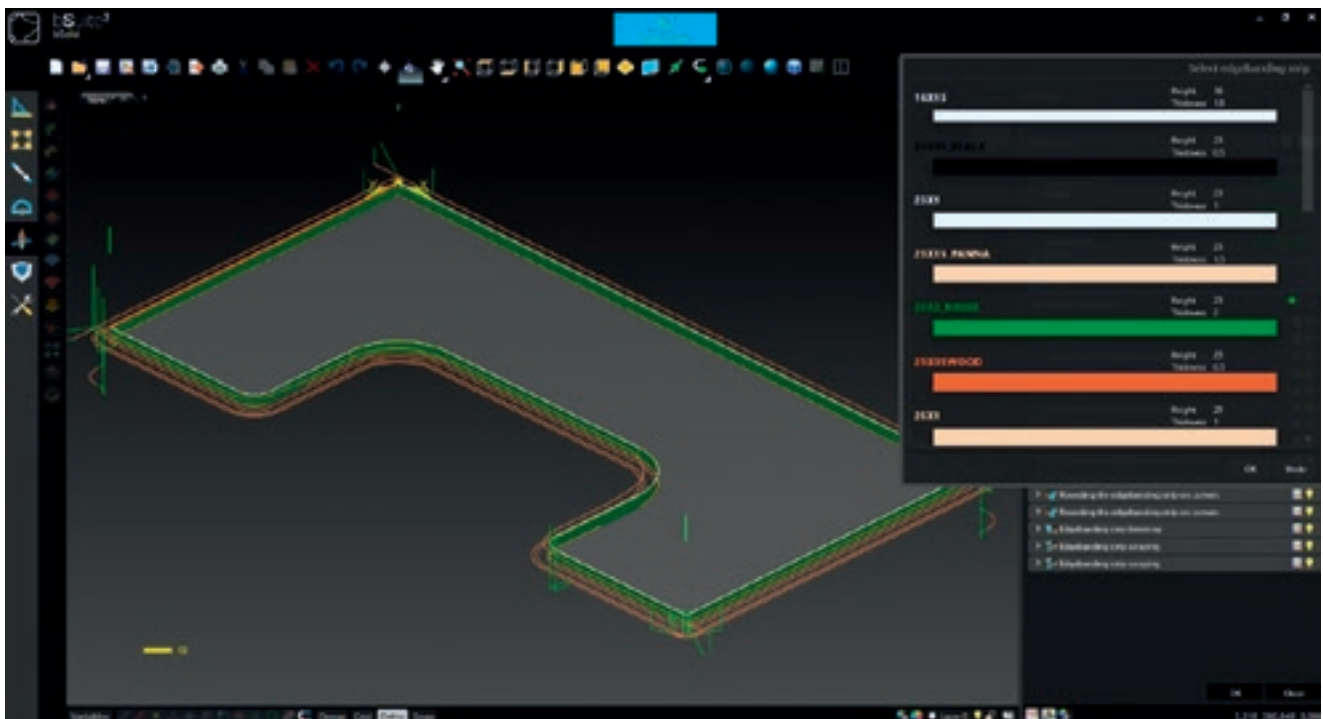

Automatic generation of the edgeworking operation sequence (pre-edgebanding, edgebanding, post-edgebanding).

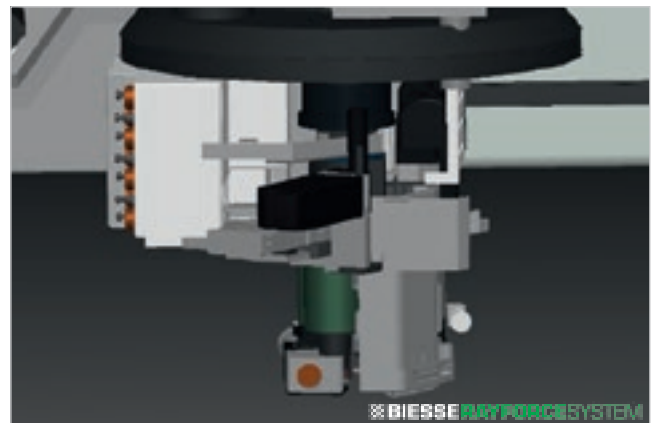
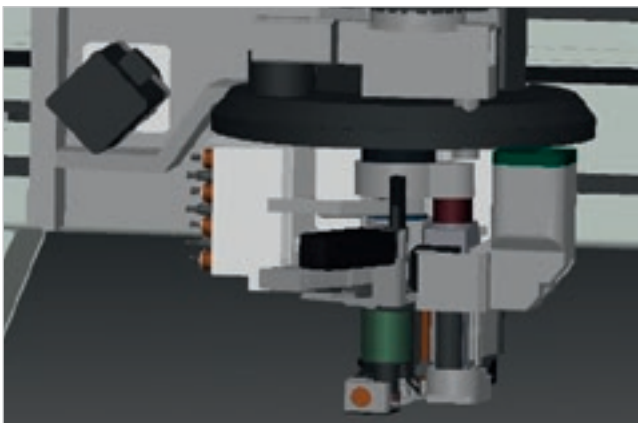

Simulation of the machining operations and the various edgeworking devices (glue or Ray Force System).



Customised configurations for simple management of the edgeworking parameters.

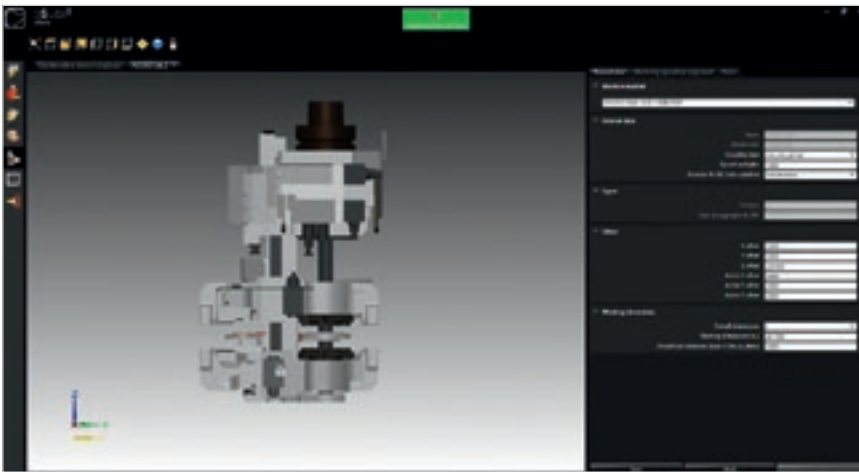
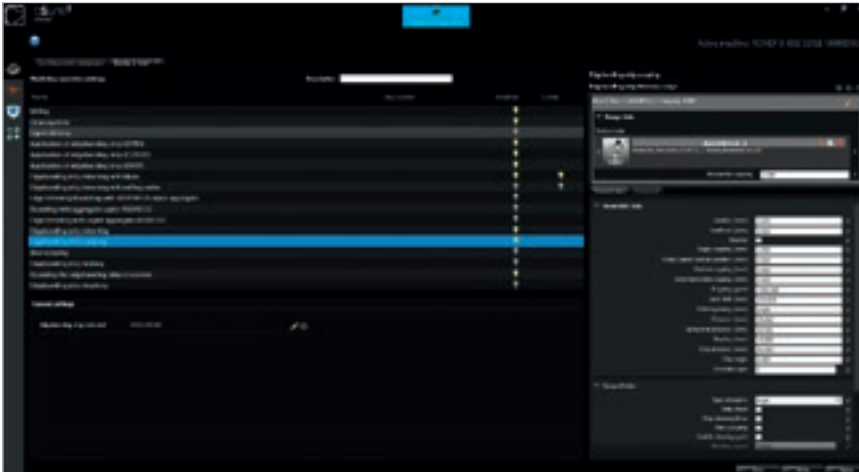

Simplified management of the post-edgeworking devices.

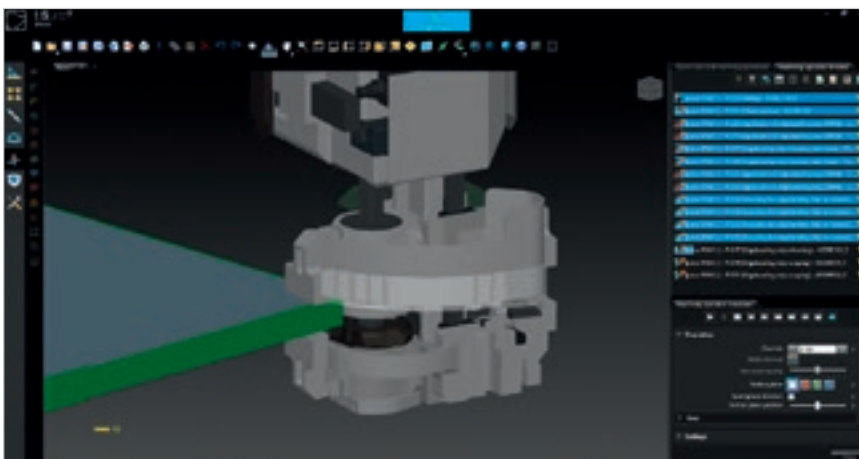

# REDUCED TIME AND WASTE



**B\_NEST IS THE B\_SUITE PLUGIN SPECIFICALLY FOR NESTING OPERATIONS. IT ALLOWS YOU TO ORGANISE YOUR NESTING PROJECTS IN A SIMPLE WAY, REDUCING THE MATERIAL WASTE AND MACHINING TIMES.**

- Flexibility with reduced production times and costs.
- Optimisation for every type of product.
- Management of articles, sheets and labels.
- Integration with company software.





# FLEXIBILITY WITH REDUCED TIMES AND PRODUCTION COSTS

B\_NEST identifies the most efficient production layout and sequence for rectangular or shaped elements, thanks to the various algorithms in the software.

Thanks to B\_NEST, production times and costs can be optimised because all the necessary pieces are produced in one single machine step, with the minimum calculated waste.

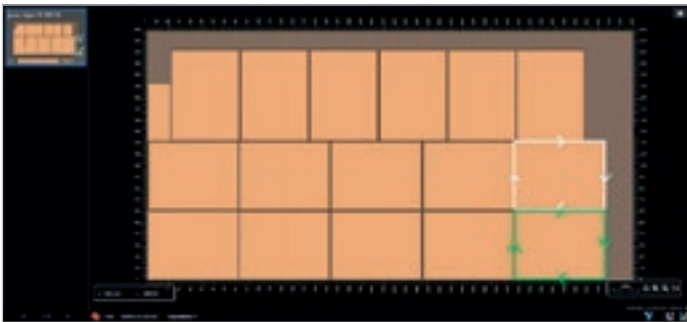

**Cutting optimizer:** all the pieces are machined with the mill making a complete movement around them.

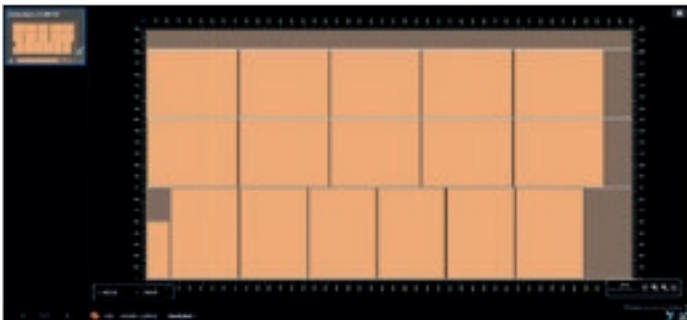

**Guillotine cut:** algorithm that positions the pieces in the same way that a panel saw would do. Where possible, milling operations are longitudinal or transverse in relation to the sheet.

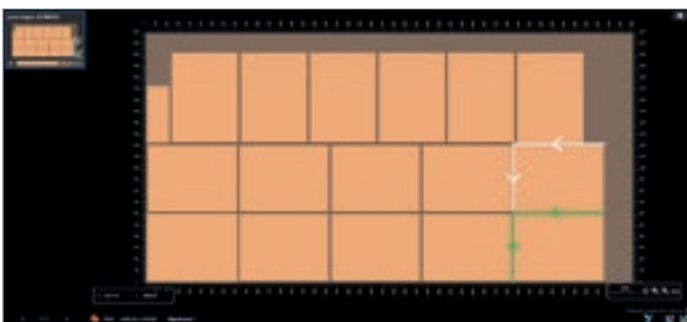

**Common cut algorithm:** this algorithm positions the pieces so that a single tool movement can be made along the shared piece sections.

A choice of nesting algorithms means that the best compromise between waste, finish and execution time can be defined.



# OPTIMISATION FOR EVERY TYPE OF PRODUCT

Various calculation options allow B\_NEST to generate specific nesting layouts for the customer's type of production.

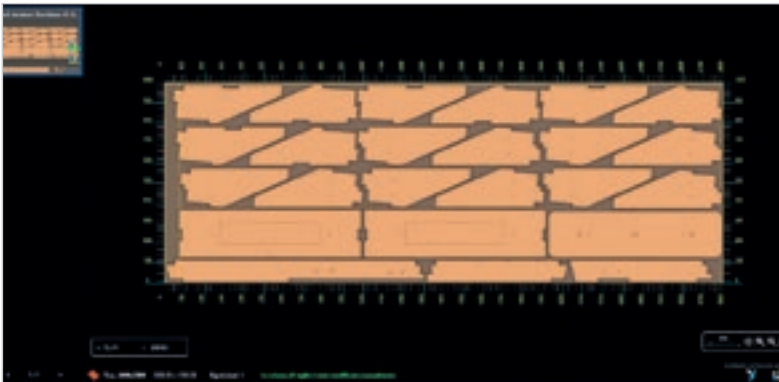

**Free-shape nesting:** guarantees the minimum waste for pieces of any shape.

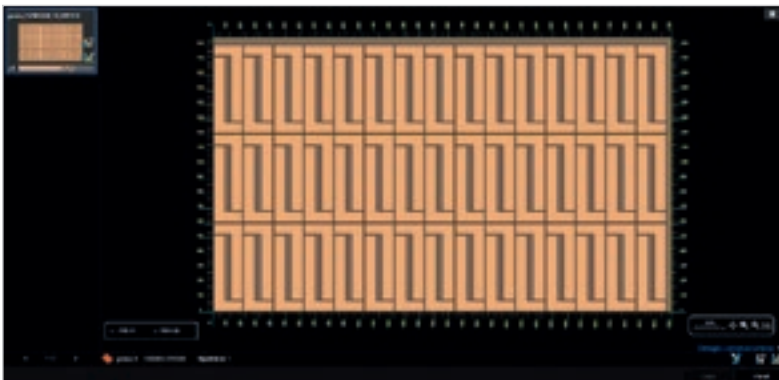

**Cluster:** the cluster function combines the pieces in sub-groups to reduce waste.

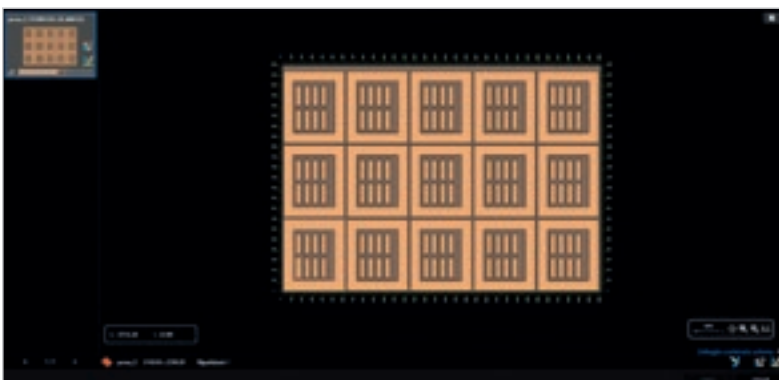

**Openings management** to fill the openings inside the pieces.

# MANAGEMENT OF ARTICLES, SHEETS AND LABELS

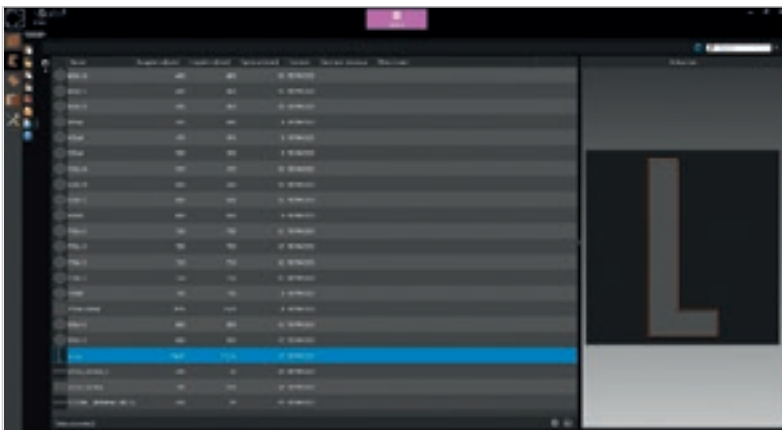

**Managing articles:** the articles are shown on the screen, making it easier to select them. They can also be arranged in folders so they're easier to manage.

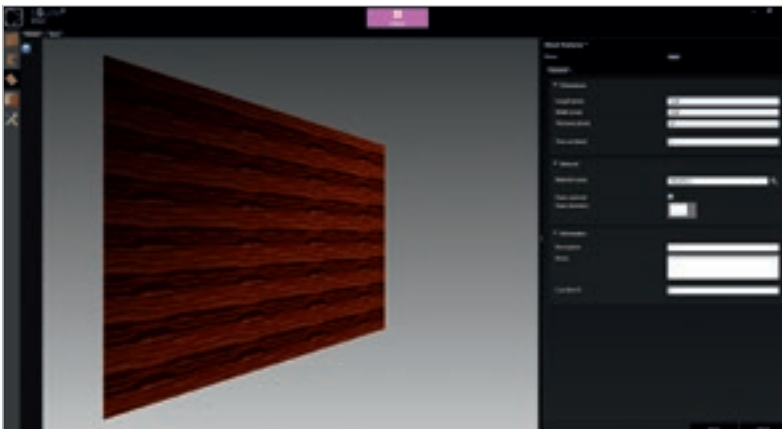

**Managing sheets**



**Labels:** B\_NEST is used to create and modify the labelling layout, adding information obtained from the customer's database software. B\_NEST can manage both bar codes and QR codes.

## B\_NEST evolves to meet the needs of even the most demanding customer.

As the market moves forward, B\_NEST adds increasingly advanced functions to keep up with the times.

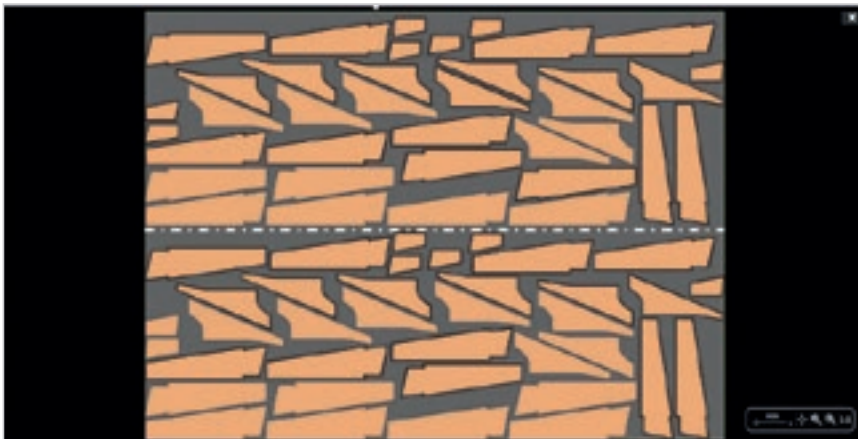

**Results cloning:** the perfect combination of technology and software. B\_NEST goes hand in hand with the evolution of Biesse's machining centres with two operating units.

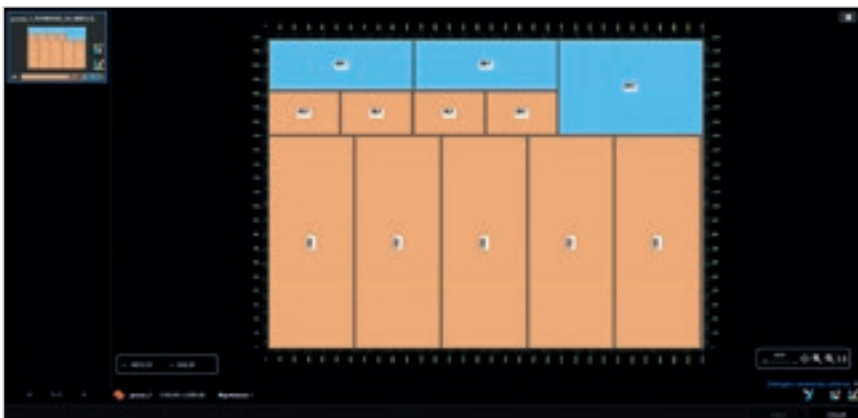

**Rest management (opt):** automatic management of material considered reusable on the basis of criteria set by the user.

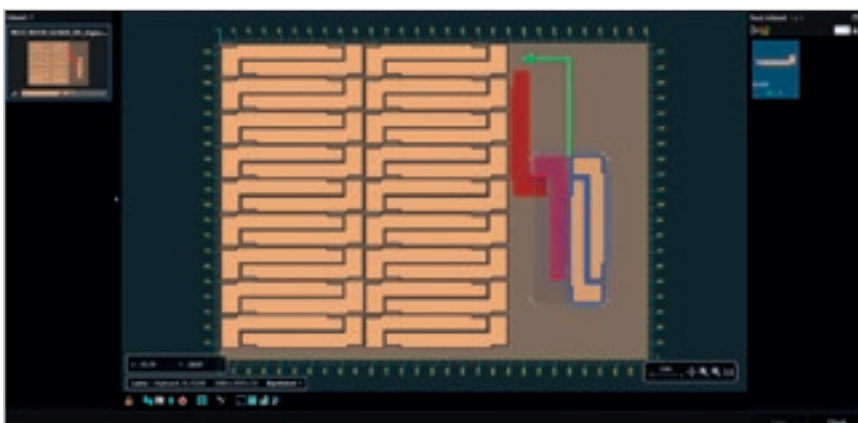

**Manual results editor (opt):** a simple, user-friendly environment for modifying the nesting results. The editor has tools that simplify the manual filling of the sheets.

# MAXIMUM DESIGN FREEDOM



**B\_WINDOW IS A SEAMLESSLY INTEGRATED PLUG-IN FOR THE PLANNING OF WINDOWS/DOOR FRAMES. BY EXPLOITING B\_SUITE'S PLANNING FUNCTIONALITY, B\_WINDOW PROVIDES UNPARALLELED CAPABILITIES.**

- ✓ Creation of window/door frames even with extremely complex designs.
- ✓ Ability to visualise all components and composition of the products to be manufactured.
- ✓ Precise calculation of the timing of job lists generated by an entire order.

# B\_WINDOWS

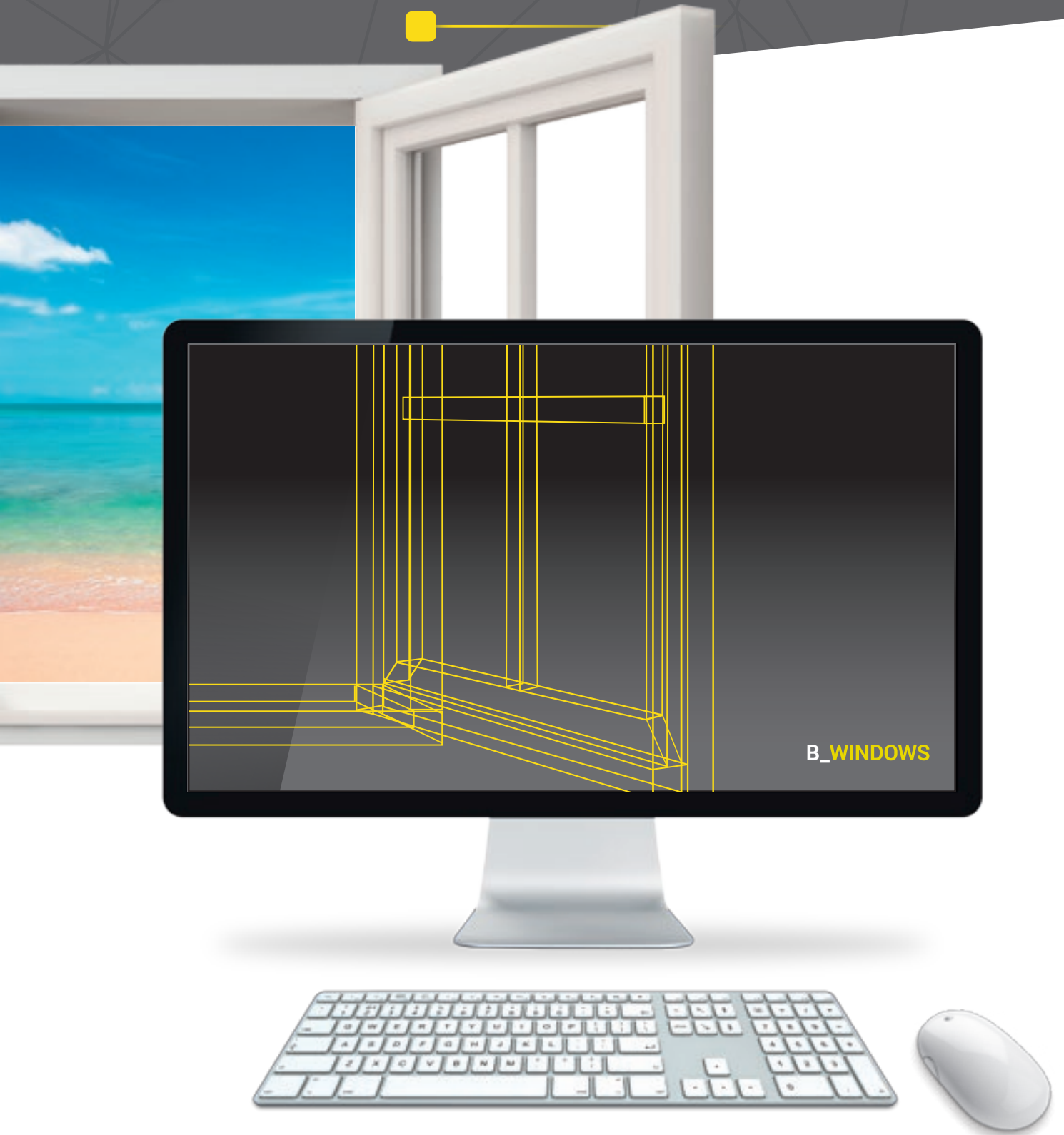

# CREATION OF WINDOW/DOOR FRAMES EVEN WITH EXTREMELY COMPLEX DESIGNS

B\_WINDOWS's potential is such that it supports the design of all types of window/door frames. It can manage extremely complex products in terms of number and types of components.

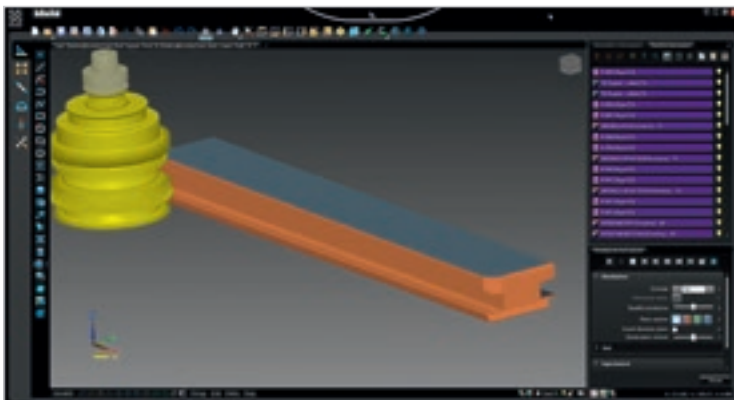
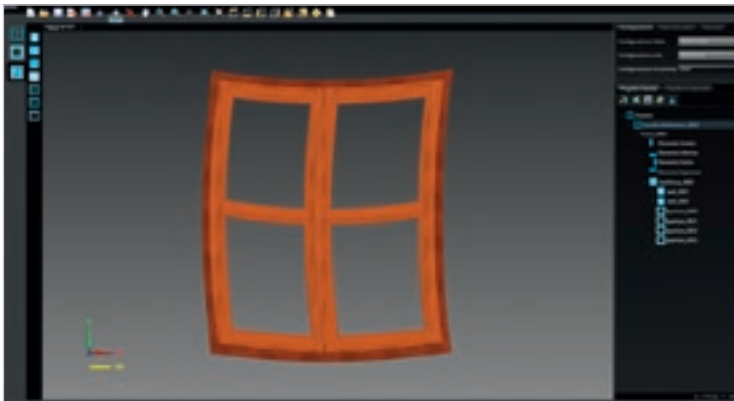

The software contains the basic know-how, supplied by Biesse, regarding the machining operations to be carried out in this type of process. The customer just need to indicate which tools are available, and bWindows will process the information and create the project automatically.

**Substantial reduction in set-up time.**

**Ability to visualise all components and composition of the products to be manufactured.**

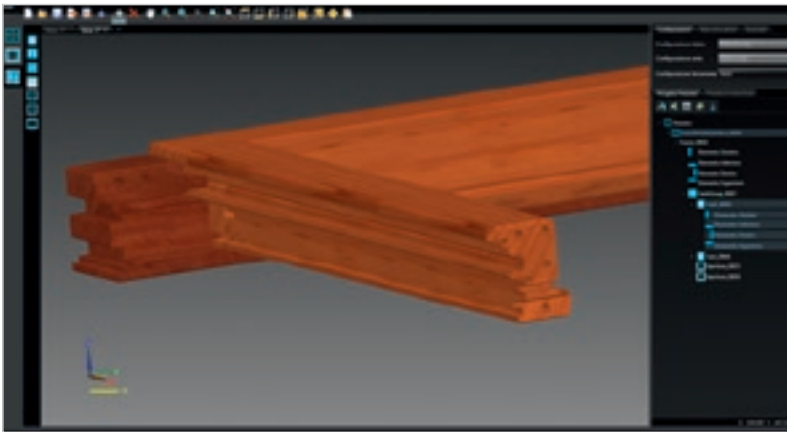

B\_WINDOWS offers the possibility to verify the specifications of the product to be manufactured. All components and characteristics (size, junctions, individual components, finishes) of a work piece can be checked even before it is simulated or processed.

**Precise calculation of the timing of job lists generated by an entire order.**



B\_WINDOWS enables the precise calculation of door and window processing times, by virtue of its seamless integration with bSuite and its innovative job list management: a uniquely reliable estimation tool that only Biesse can offer to its customers.

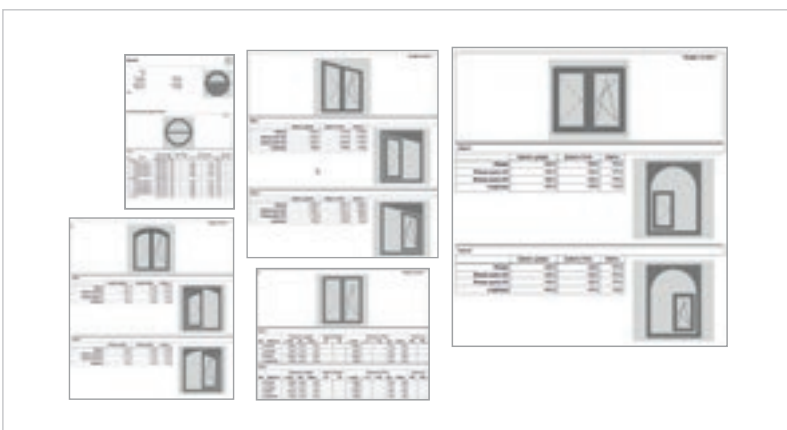

Management of printouts and glass list for the internal and/or external production of an order's complementary components.

# SIMPLE AND PRACTICAL



**B\_DOORS IS A PERFECTLY INTEGRATED,  
INTUITIVE AND PRACTICAL B\_SUITE  
PLUG-IN FOR DESIGNING DOORS.**

- ✓ Creation of doors with elements and honeycomb sandwich panels.
- ✓ Simplified, parametric creation of uprights and shaped crossbars for doors with elements.
- ✓ Precise calculation of the timing of job lists generated by an entire order.



B\_DOORS

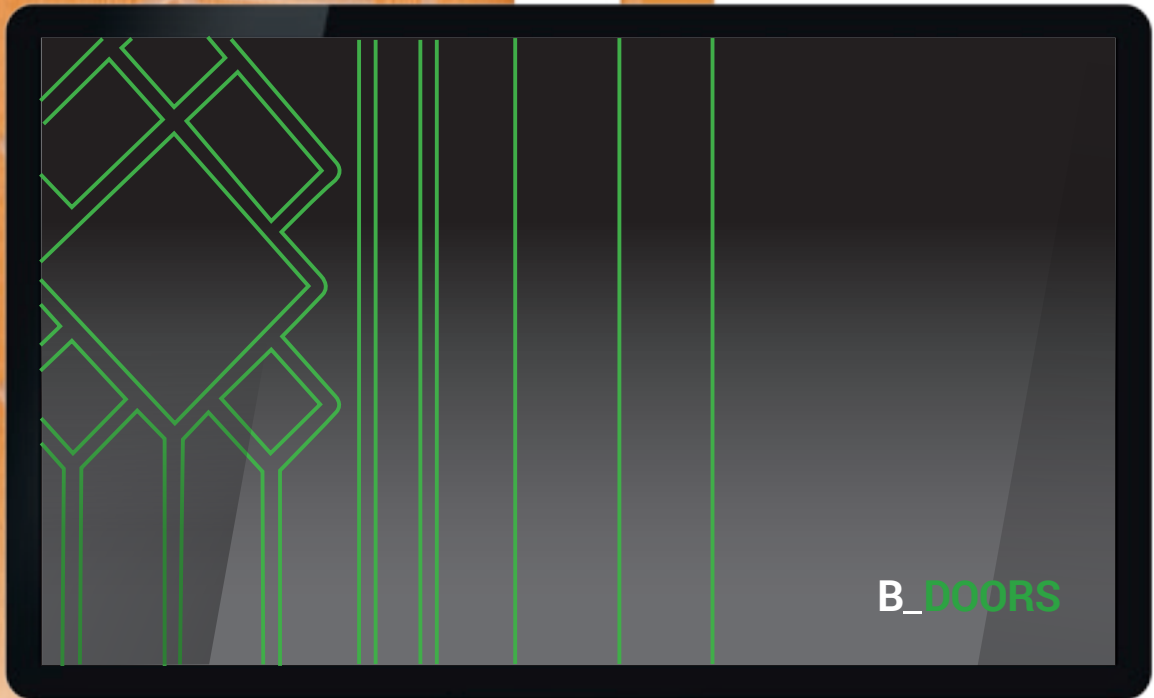

# CREATION OF DOORS WITH COMPLEX SHAPES

B\_DOORS can be used to design any type of door. For easy management of products with complex shapes.

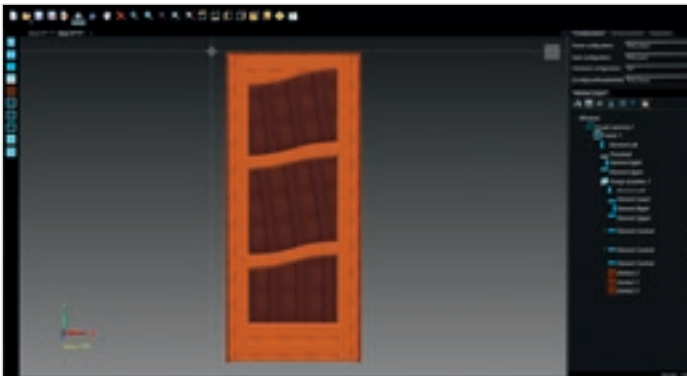

Management of doors with elements and honeycomb sandwich panels.

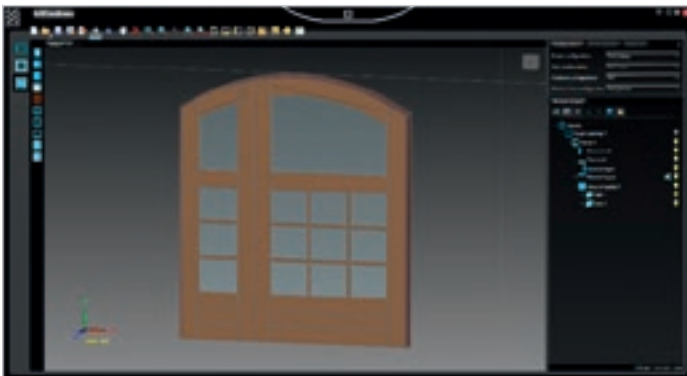

Central division elements.

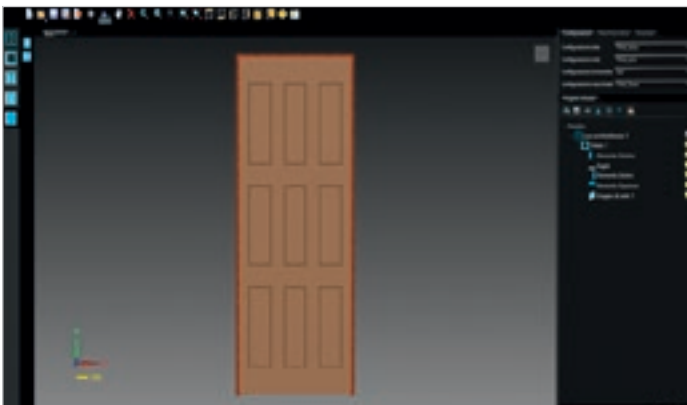

Possibility to view all the components and characteristics of the product being created.

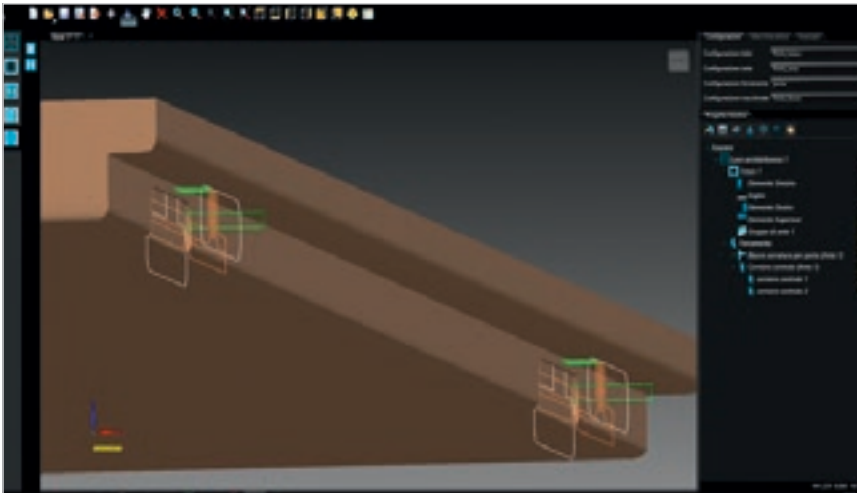

- ▣ Management of parametric-shaped slotting.
- ▣ Opening of corners for frame insertion.
- ▣ Management of milled doors.
- ▣ Parametric creation of radiusing and fake horizontal and vertical slats.

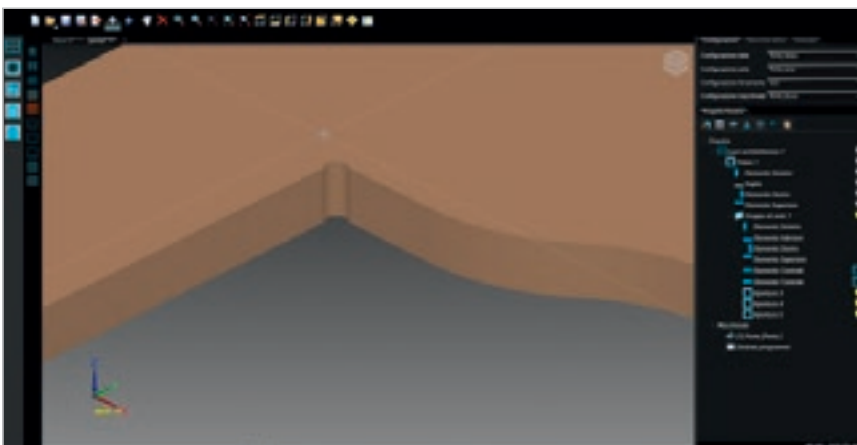
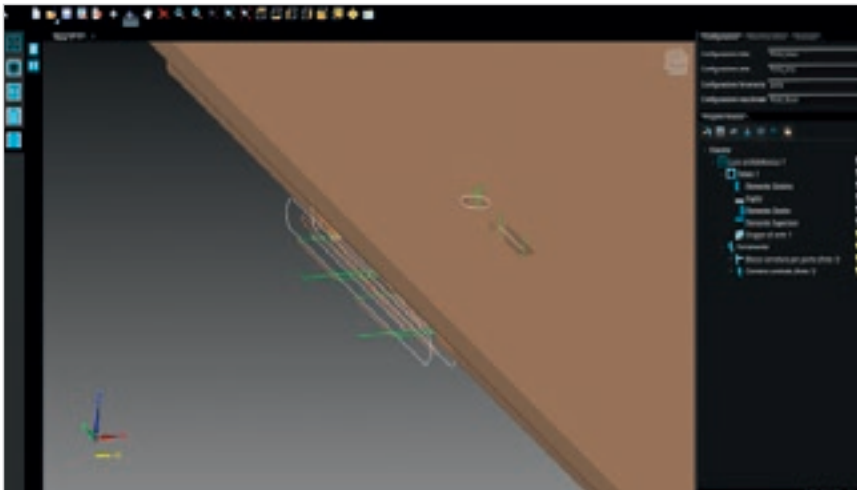

# MADE WITH BIESSE

## REDUCED COST AND PROCESSING TIMES, GREATER BENEFITS AND COMPETITIVENESS

"Biesse has always been a reference point for us;" states Mirco Molteni "we have always worked extremely closely with them so that they could be very familiar with end user requirements, and be almost like another tool for us. Now we have become self-sufficient even for complex processes. We manufacture custom pieces and, thanks to bSolid's user-friendliness, we can turn them around within very short time lines. It is so convenient that we are gradually moving more and more processes - even simple ones - on the centre equipped with bSolid. We can complete a drawing's development process and move on to production within one hour, which is something we only used to be able to do in a day. bSolid is intuitive, parametric, more powerful and versatile, particularly for surfaces. With bSolid all you need

to do is set the dimensions, in a quick and easy way, follow the instructions and then the work piece is visualised on the screen, together with all operations needed to process it. Once the drawing in the system, bSolid automatically programmes all necessary processing operations, down to specifying which tool to use. And if I have designed a complex piece and realise that I have made a mistake, I don't have to start again from scratch: all I need to do is insert the necessary changes and... job done! The new Biesse software goes through a verification stage and suggests a 3-D simulation, highlighting any problems, of any type, also thanks to the anti-collision system. In short, an operator can programme the component to be manufactured in just a few, easy steps, verifying tool paths, identifying the most suitable

tool and seeing how tool changes will be executed, through to the end result. At this point, he/she can start real production with no risks! Working together with Biesse to make sure that this software program takes into account the requirements and way of thinking of us furniture manufacturers was a fantastic opportunity", stresses Mr. Molteni. "I think they have managed to understand our needs and have created a tool that is very sophisticated and yet easy to use at the same time, that manages to put even the most conservative joiners at ease...".

*Source: XYLON September-October 2013MCM, a Biesse customer since 1992, is one of the main manufacturers of custom, high-end furniture*



# LIVE THE EXPERIENCE

BIESSEGROUP.COM

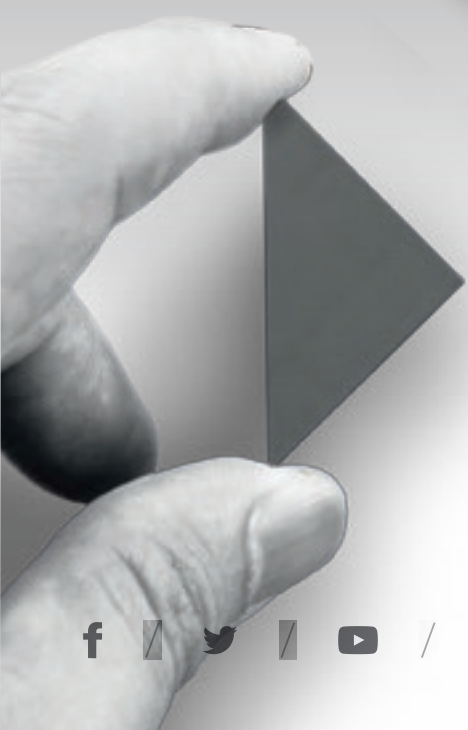

Interconnected technologies and advanced services that maximise efficiency and productivity, generating new skills to serve better our customer.

**LIVE THE BIESSE GROUP EXPERIENCE AT OUR CAMPUSES ACROSS THE WORLD.**



# SERVICE & PARTS

Direct, seamless co-ordination of service requests between Service and Parts. Support for Key Customers by dedicated Biesse personnel, either in-house and/or at the customer's site.

## BIESSE SERVICE

- ✔ Machine and system installation and commissioning.
- ✔ Training centre dedicated to Biesse Field engineers, subsidiary and dealer personnel; client training directly at client's site.
- ✔ Overhaul, upgrade, repair and maintenance.
- ✔ Remote troubleshooting and diagnostics.
- ✔ Software upgrade.

**500**

Biesse Field engineers in Italy and worldwide.

**50**

Biesse engineers manning a Teleservice Centre.

**550**

certified Dealer engineers.

**120**

training courses in a variety of languages every year.

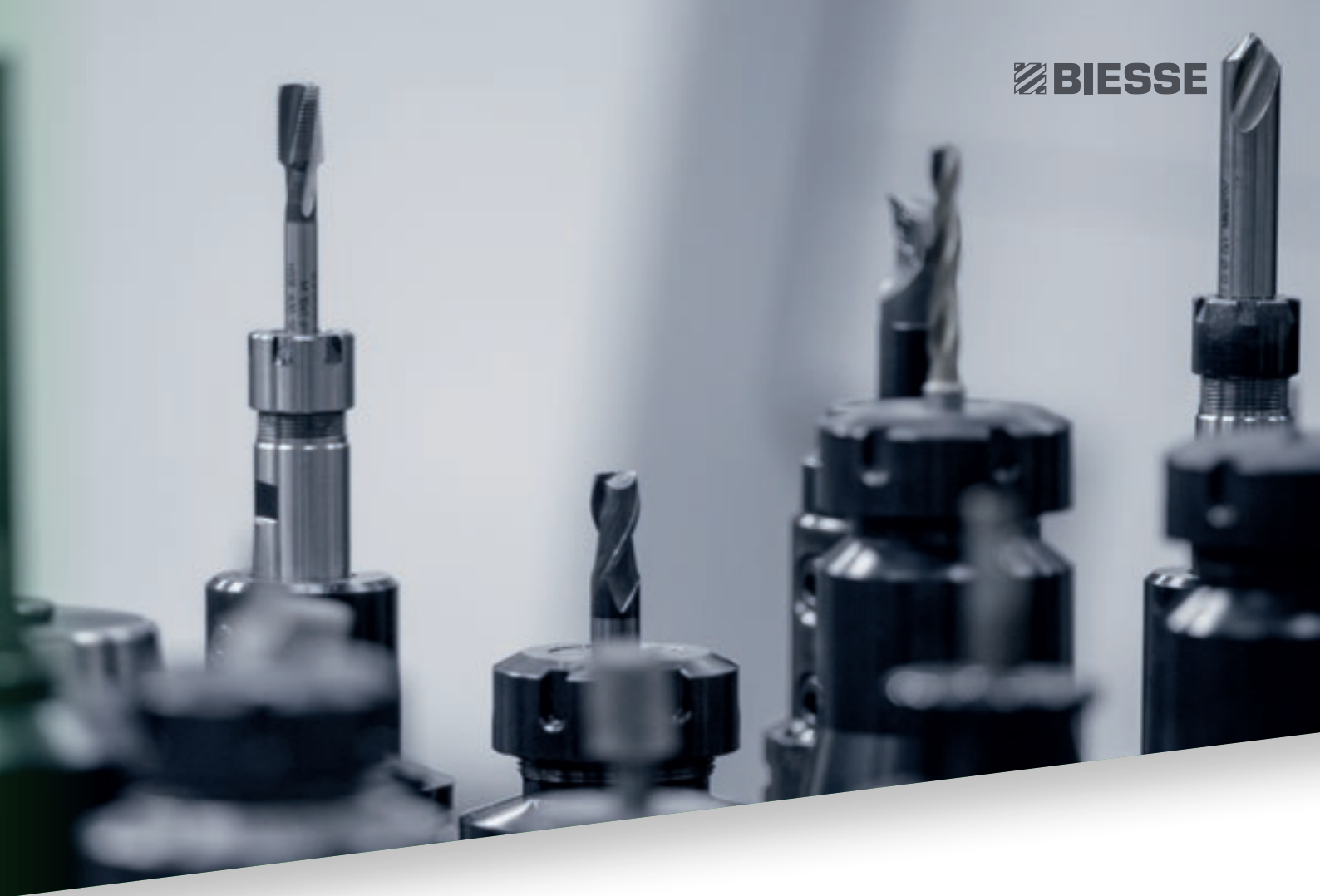
A close-up photograph of several metal drill bits and tool components, arranged in a row. The bits are of different sizes and designs, some with standard double-flute and others with more complex, multi-fluted designs. They are set against a blurred background, highlighting their metallic texture and sharp edges.

The Biesse Group promotes, nurtures and develops close and constructive relationships with customers in order to better understand their needs and improve its products and after-sales service through two dedicated areas: Biesse Service and Biesse Parts. With its global network and highly specialized team, it offers technical service and machine/component spares anywhere in the world on-site and 24/7 on-line.

## BIESSE PARTS

- ✔ Original Biesse spares and spare kits customized for different machine models.
- ✔ Spare part identification support.
- ✔ Offices of DHL, UPS and GLS logistics partners located within the Biesse spare part warehouse, with multiple daily pick-ups.
- ✔ Order fulfillment time optimized thanks to a global distribution network with de-localized, automated warehouses.

**92%**  
of downtime machine orders fulfilled  
within 24 hours.

**96%**  
of orders delivered in full on time.

**100**  
spare part staff in Italy and worldwide.

**500**  
orders processed every day.

