

Rover A

Centri di lavoro a controllo numerico
Numerical control machining centres



 **BIESSE**
ALL IN ONE

Rover A

Una compatta di carattere
Il massimo della tecnologia è di serie
Compact with robust capabilities
The best of technology bundled together



Elettromandri ISO 30 o HSK F63 da 12 kW di potenza per grosse asportazioni.

ISO 30 or HSK F63 electrospindles, 12 kW power, to remove large amounts of material.

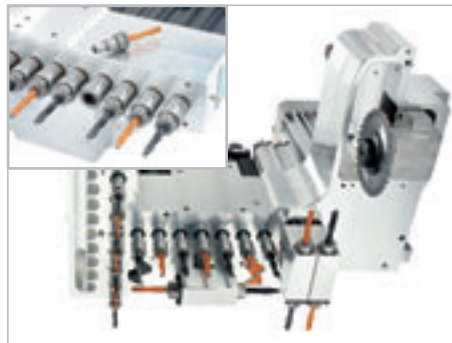

Testa a forare a 21 utensili.
Mandri ad attacco rapido per una facile e veloce sostituzione delle punte.
Velocità di rotazione fino a 6000 giri/min gestita da inverter.

21 tools boring head.
Spindles with quick coupling system for fast, easy replacement of bits.
Rotation speeds of up to 6000 rpm managed by inverter.



Completa visibilità della lavorazione in totale sicurezza.

Complete visibility of machining operations in total safety.

Rover A è il centro di lavoro compatto e prestazionale, ideato per la produzione di mobili, porte in tamburato, porte in massello ad elementi, finestre e scale. È la macchina ideale per artigiani, piccole aziende e reparti prototipi di grandi aziende.

Rover A is the compact machining centre designed for high performances capable of meeting various levels of production requirements. It's the ideal machine for those who require a flexible and reliable solution.



Rover A

Configurazione del gruppo operatore
Operating unit configuration



Pantografo orizzontale ad uscita diretta in posizione posteriore per asportazioni veloci e consistenti.

A powerful direct output horizontal electrospindle is available at the rear for fast and consistent pocketing.

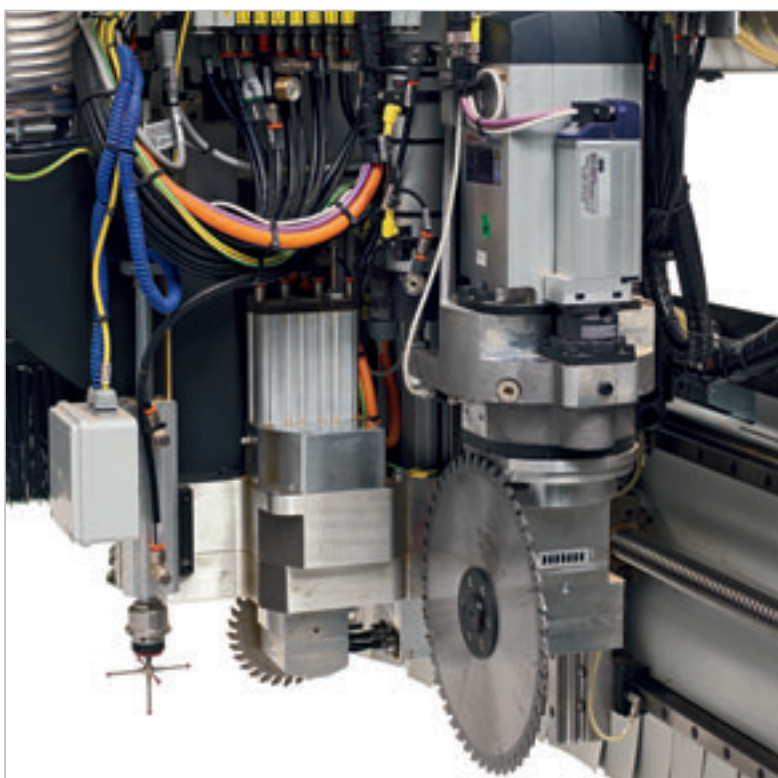

Gruppo multifunzione con aggregato per lama, ruotabile da C. N. di 360° in continuo.

Multifunctional unit with aggregate for sawblade unit - N.C. rotation through 360°.

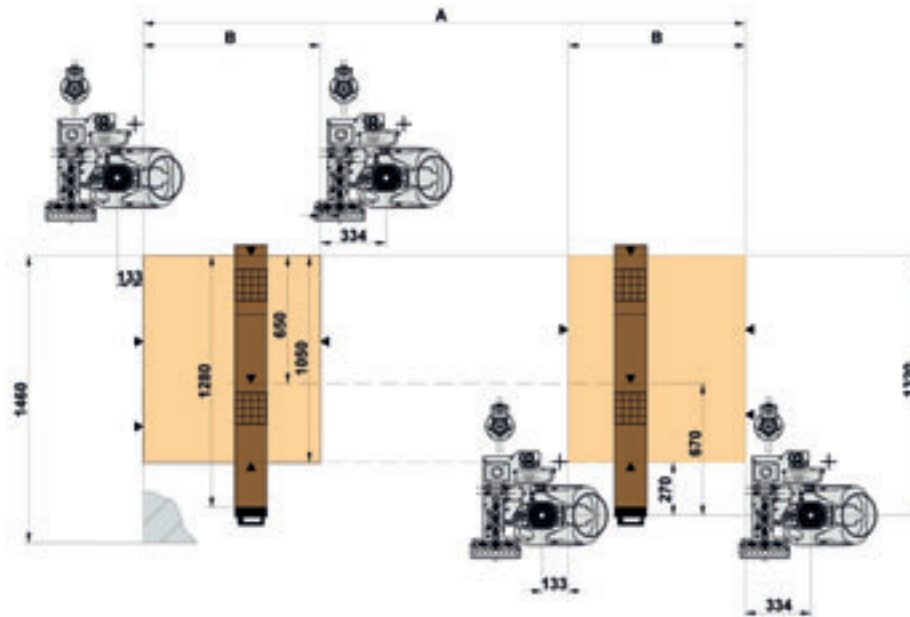

	A	B	MAX
Rover A 4.30 CE	3060	900	1460
Rover A 4.55 CE	5680	2210	1460

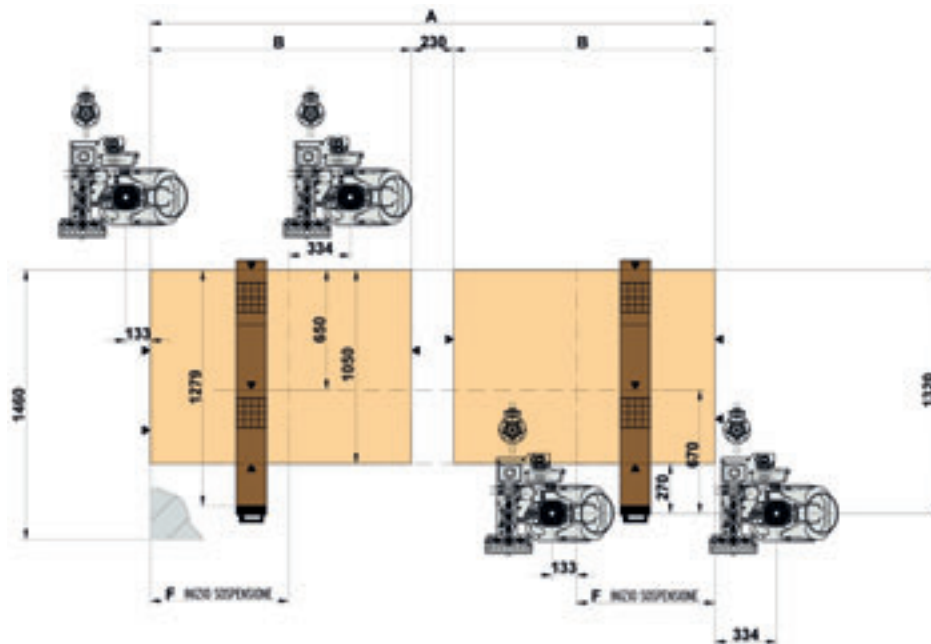

	A	B	F	MAX
Rover A 4.30 NCE	3060	1415	750	1460
Rover A 4.55 NCE	5680	2725	2060	1460

Battute posteriori per il posizionamento dei pezzi di grandi dimensioni.
 Battute anteriori per un comodo posizionamento dei pezzi di piccole dimensioni.

*Rear stops for positioning of large pieces.
 Front stops for easy positioning of small pieces.*

Rover A

La soluzione per ogni esigenza
Responding to every need



ISO30
HSK F63



ISO30
HSK F63



ISO30
HSK F63



HSK F63



ISO30
HSK F63



HSK F63



ISO30
HSK F63



ISO30
HSK F63



Cambio utensili rapido ed affidabile Fast and reliable tool changer



Il magazzino utensili a revolver a 24 posti a bordo carro X permette di avere fino a 24 utensili sempre disponibili in qualunque punto della macchina e di cambiare utensile in tempi brevi. (Rover A 4.30 k2 k3, Rover A 4.55 k1 k2)

The revolving tool changer with 24 places at X carriage side allows to have up to 24 tools and aggregates always available where required on the machine and to perform tool change in a little time. (Rover A 4.30 k2 k3, Rover A 4.55 k1 k2)



Magazzino utensili a revolver a 10 posti.

Alloggiato a bordo del carro "X", consente di avere fino a 10 utensili e aggregati sempre disponibili in qualunque punto della macchina e di effettuare il cambio utensile in tempi brevi. (Rover A 4.30 k1)

Revolving tool changer with 10 places.

Installed on the X carriage, it allows to have up to 10 tools and aggregates always available where required on the machine, therefore reducing the tool change time. (Rover A 4.30 k1)

Rover A

Il piano di lavoro per ogni esigenza
The work table to suit every need



Il sistema di aggancio rapido garantisce una sostituzione agevole e veloce dei moduli del vuoto con le morse.

The quick coupling system guarantees fast, simple replacement of vacuum modules with clamps.

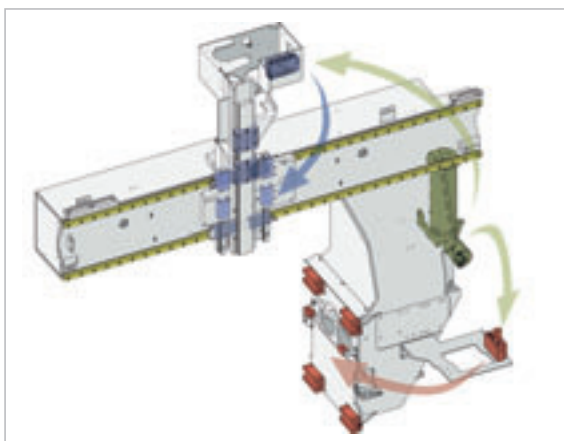

Sistema di lubrificazione automatico per ridurre gli interventi di manutenzione da parte dell'operatore.

Automatic lubrication system to reduce the need for maintenance by the operator.

Sistema di scorrimento dei piani di lavoro su guide lineari e pattini a ricircolo di sfere.

Work table sliding system using linear guides and ball bearings.

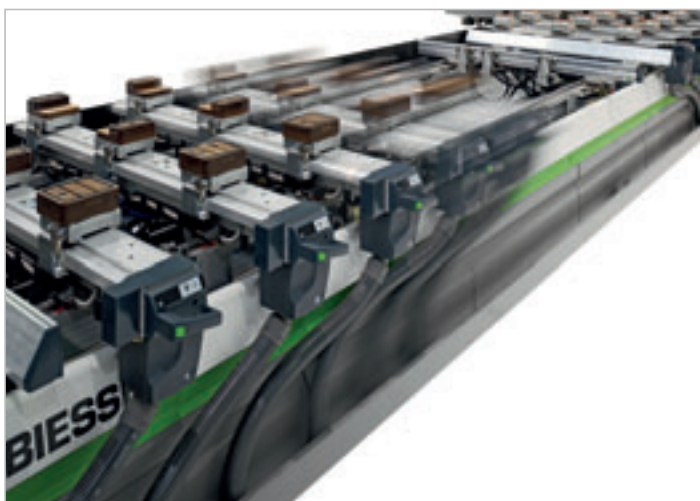

EPS (Electronic Positioning System) permette di riconfigurare automaticamente l'intera area di lavoro in meno di 30 secondi. Posiziona i piani ed i carrelli tramite motorizzazioni indipendenti, quindi senza impegnare l'unità operatrice. Il posizionamento di piani e carrelli di un'area viene eseguito in tempo mascherato mentre la macchina lavora sull'area opposta.

EPS (Electronic Positioning System) allows the entire working area to be reconfigured automatically in less than 30 seconds. It positions the panel supports and carriages using independent drives, and therefore without using the operating section. Positioning of panel supports and carriages within an area is carried out in masked time, while the machine is working in the opposite area.

Bloccaggio simultaneo di diversi componenti Simultaneous locking of various components

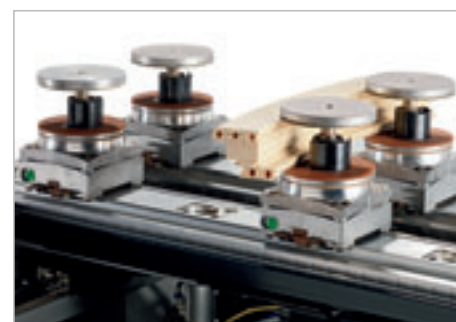
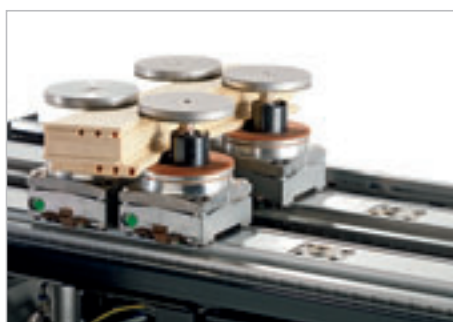
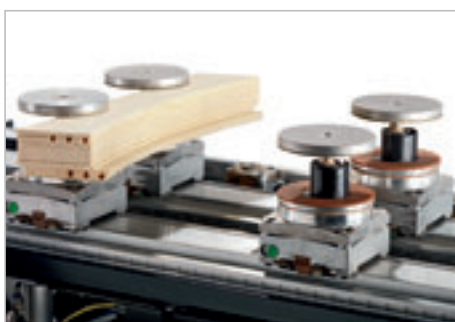

Grazie al sistema di posizionamento multiplo è possibile bloccare contemporaneamente gli elementi da processare, ottimizzando le lavorazioni per ciascun ciclo e riducendo il tempo complessivo di lavorazione.

Thanks to the multiple positioning system it is possible to lock the elements to be processed simultaneously, optimising machining operations for each cycle and reducing overall production times.

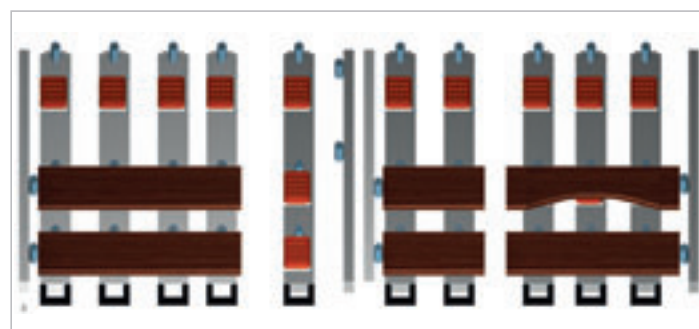

Montanti e traversi di una porta ad elementi

Door uprights and rails

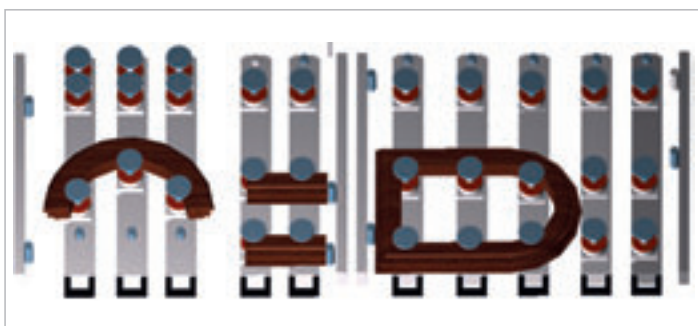

Elementi di una finestra ad arco.
Squadratura di una finestra ad arco

*Arched window elements.
Squaring of an arched window.*

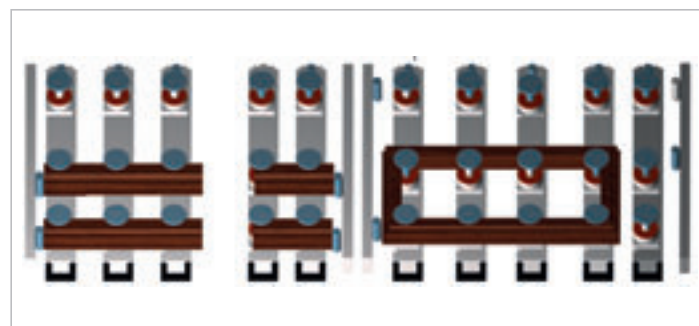

Montanti e traversi di una finestra.
Squadratura di una finestra.

*Window stiles and rails.
Squaring of a window.*

Rover A

Efficiente in tutte le lavorazioni
Effective during all machining operations



Lavorazione di porte in tamburato.

Machining of core panel doors.



Lavorazione di portoncini ad elementi.

Machining of door elements.



Lavorazione di finestre lineari e ad arco.

Machining of straight and arched windows.



Lavorazione di componenti del mobile/arredamenti.

Machining of furniture components/furnishings.

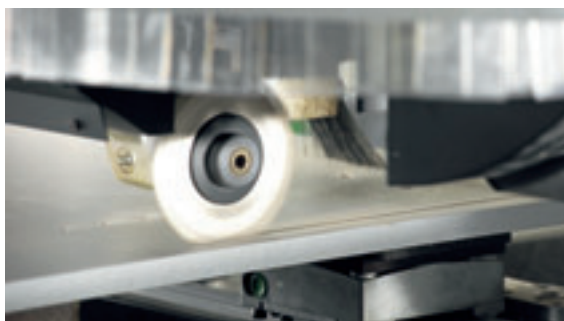

Dalla parte dell'operatore
On the operator's side

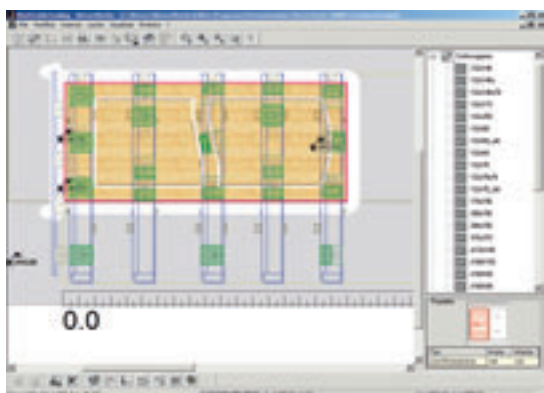

Attrezzaggio grafico per la definizione del posizionamento dei piani di lavoro, dei carrelli, tipo ed orientamento della controsagoma.

Graphic set up of panel support, carriages, type and orientation of the vacuum modules.

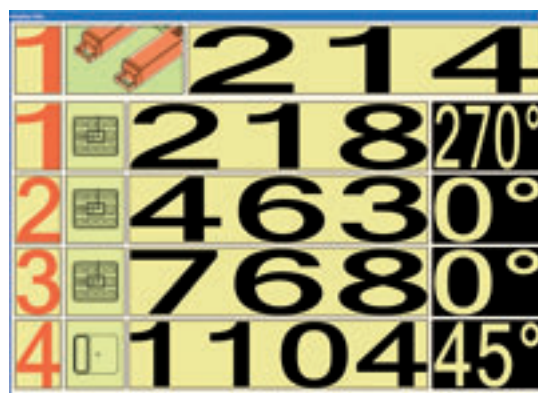

Le quote dell'attrezzaggio dell'area di lavoro sono visualizzate sul monitor del PC a bordo macchina.

The positions for the working area set up are displayed on the machine PC monitor.



Cuffia di aspirazione regolabile su 5 posizioni da CN.

Suction hood adjustable to 5 positions from the NC.

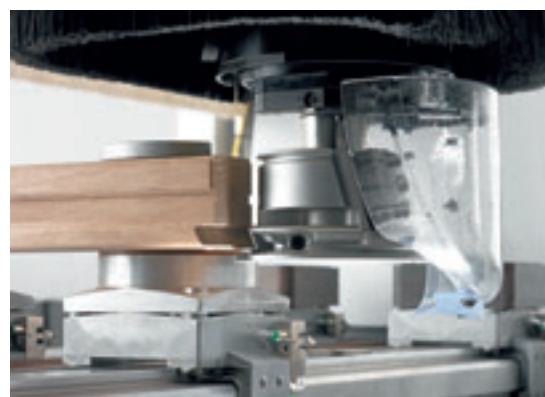

Convogliatore di trucioli gestito da controllo numerico.

Numerically controlled chip removal conveyor.



Ogni funzione è a portata di mano.

Every function within reach.



Tappeti motorizzati per la rimozione di trucioli e sfridi.

Driven conveyors for removal of chips and waste material.

Rover A

Hardware e Software
Hardware and Software



Sistema di controllo XP600 su base PC:

- PC con sistema operativo Windows real-time per il controllo della macchina;
- controllo assi interpolati in tempo reale;
- gestione dei segnali di input/output;
- esecuzione in tempo reale della logica di macchina;
- totale connettività in rete;
- gestione del lettore di codice a barre;
- tasti dedicati all'attivazione delle funzionalità della macchina.

PC-based XP600 control system:

- PC with real-time Windows operating system controlling the machine;
- real-time control of interpolating axes;
- input/output signal management;
- real-time execution of machine logic;
- total connectivity;
- bar code reader management;
- dedicated machine function enable buttons.

Biesse adotta di serie il condizionatore d'aria sull'armadio elettrico per un perfetto funzionamento dei componenti elettronici, anche a temperature ambienti elevate. Il condizionatore garantisce inoltre un'ottima protezione dalla polvere in quanto la cabina elettrica è priva di ventole di aerazione.

Biesse uses air conditioners as a standard feature in the electrical cabinet, for perfect operation of electronic components even at high room temperatures. The conditioner also guarantees excellent protection from dust, as the electrical cabin has no ventilation fans.



Protezione integrale del gruppo operatore e massima visibilità per lavorare in totale sicurezza.

All-round protection of the working unit and maximum visibility for safe operations.

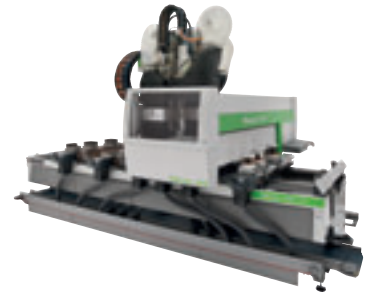

L'interfaccia grafica a finestre BiesseWorks utilizza pienamente le modalità operative tipiche del sistema operativo Windows:

- editor grafico assistito per la programmazione delle lavorazioni;
- programmazione parametrica e creazione guidata di macro parametriche;
- importazione di files da CAD e da altri software esterni in formato DXF e CID3;
- programmazione parametrica dell'area di lavoro.

The BiesseWorks graphic interface makes full use of the operating methods typical of the Windows operating system:

- assisted graphic editor used to program machining operations;
- parametric programming and guided creation of parametric macros;
- import of CAD and other external software files in DXF and CID3 format;
- programming of the working area using set parameters.

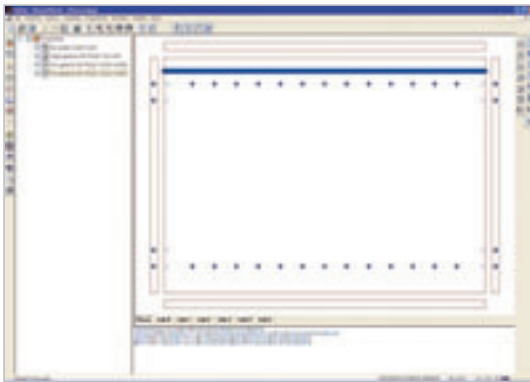

Simulazione 3D del percorso utensile. Calcolo indicativo del tempo di lavorazione. Possibilità di creare facce virtuali ruotate o circolari (opz.).

3D simulation of the tool path. Indicative calculation of machining time. Ability to create rotated or circular virtual faces (opt).

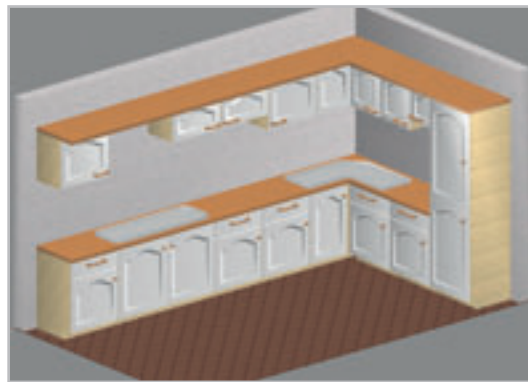

Biessecabinet: progettazione e gestione di carcasse, pensili, ripiani fissi, mensole, sportelli, cassetti e top singoli.

Biessecabinet: design and management of structures, wall units, fixed shelves, adjustable shelves, doors, drawers and individual tops.

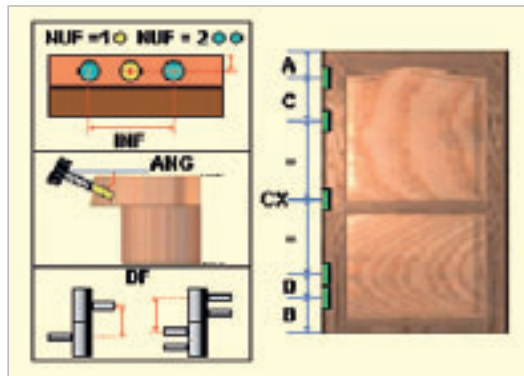
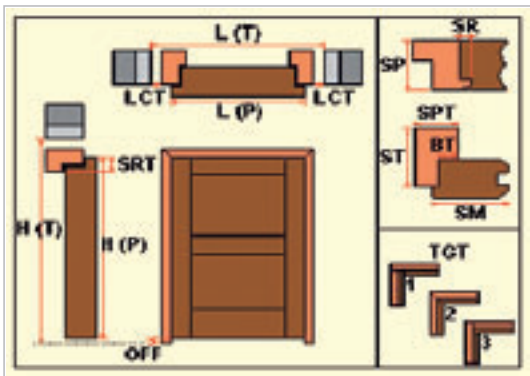

Macro per la progettazione di porte ad elementi, tamburate e pantografate.

Macros to design doors made up of elements, core panel doors and routed doors.

Rover A

Dati tecnici Technical specifications

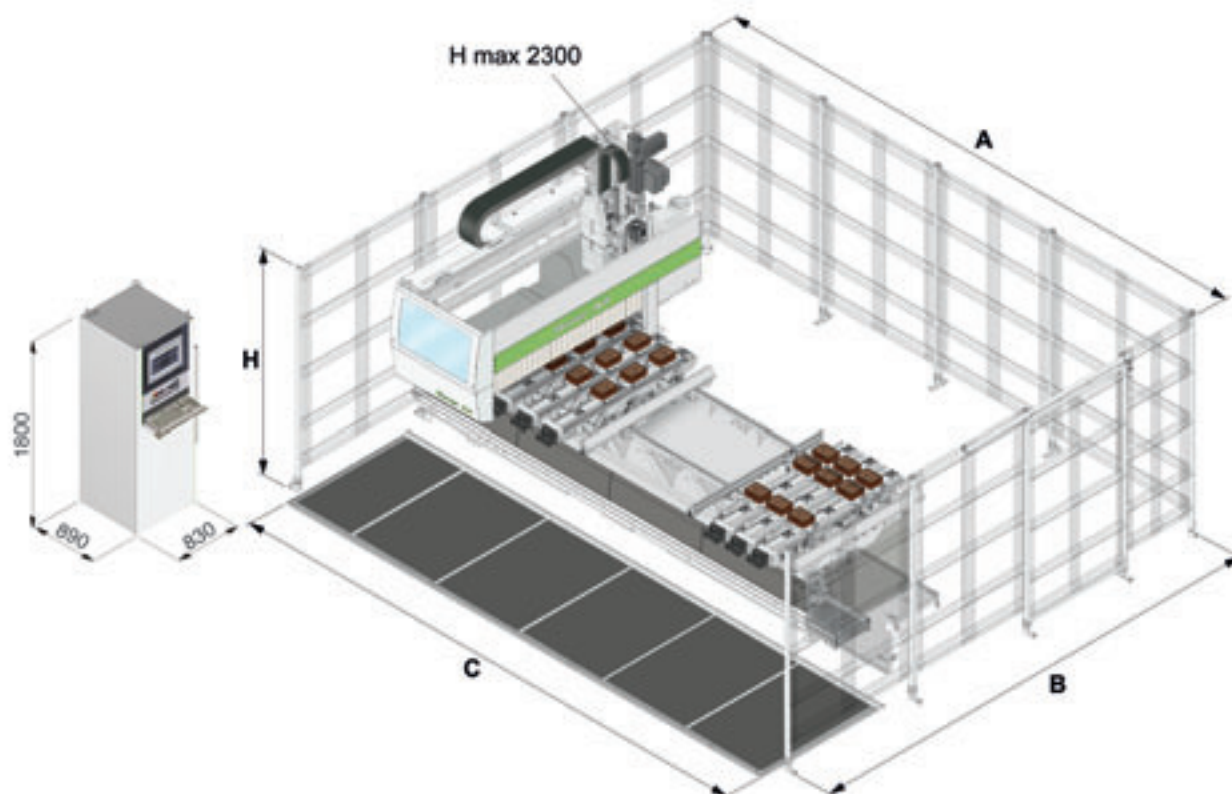

	A	B	C	H
	mm/inch	mm/inch	mm/inch	mm/inch
Rover A 4.30	5202/204,8	4496/177	4921/193,7	1980/78
Rover A 4.55	7838/308,6	4496/177	7606/299,5	1980/78

Potenza elettrica installata	<i>Installed power</i>	kVA 17	kVA 17
Consumo aria compressa	<i>Consumption of compressed air</i>	NI/1' 300	NI/1' 300
Pressione d'aria d'esercizio	<i>Working air pressure</i>	bar 7-7,5	bar 7-7.5
Attacco aria compressa	<i>Compressed air connection</i>	Ø 3/8"	Ø 3/8"
Consumo aria aspirata	<i>Air consumption for dust extraction</i>	m³/h 3400	CFM 2001
Velocità aria al collettore principale	<i>Air speed to the main collector</i>	m/s 30	ft/s 98.42
Attacco aspirazione	<i>Socket for chip suction</i>	mm Ø 250	inch Ø 9.8
Peso macchina con armadio elettrico	<i>Machine weight with electrical cabinet</i>		
Rover A 4.30		Kg 2950	Kg 2950
Rover A 4.55		Kg 3900	Kg 3900

	Campi di lavoro in X <i>Working fields in X</i>	Campi di lavoro in Y <i>Working fields in Y</i>	Passaggio pezzo <i>Loadable piece</i>	Corsa asse Z <i>Z axis stroke</i>
	mm/inch	mm/inch	mm/inch	mm/inch
	4.30 - 4.55			
Foratura/Boring	3060-5680/120,5-223.6	1460/57,5	150/5,9	200/7,9
Fresatura/Routing	3060-5680/120,5-223.6	1320/52		
Tutti gli utensili/All the tools	3060-5680/120,5-223.6	1123/44,2		

Velocità assi X/Y/Z	<i>Axes speed X/Y/Z</i>	m/min 80/80/25	ft/min 263/263/82
---------------------	-------------------------	----------------	-------------------

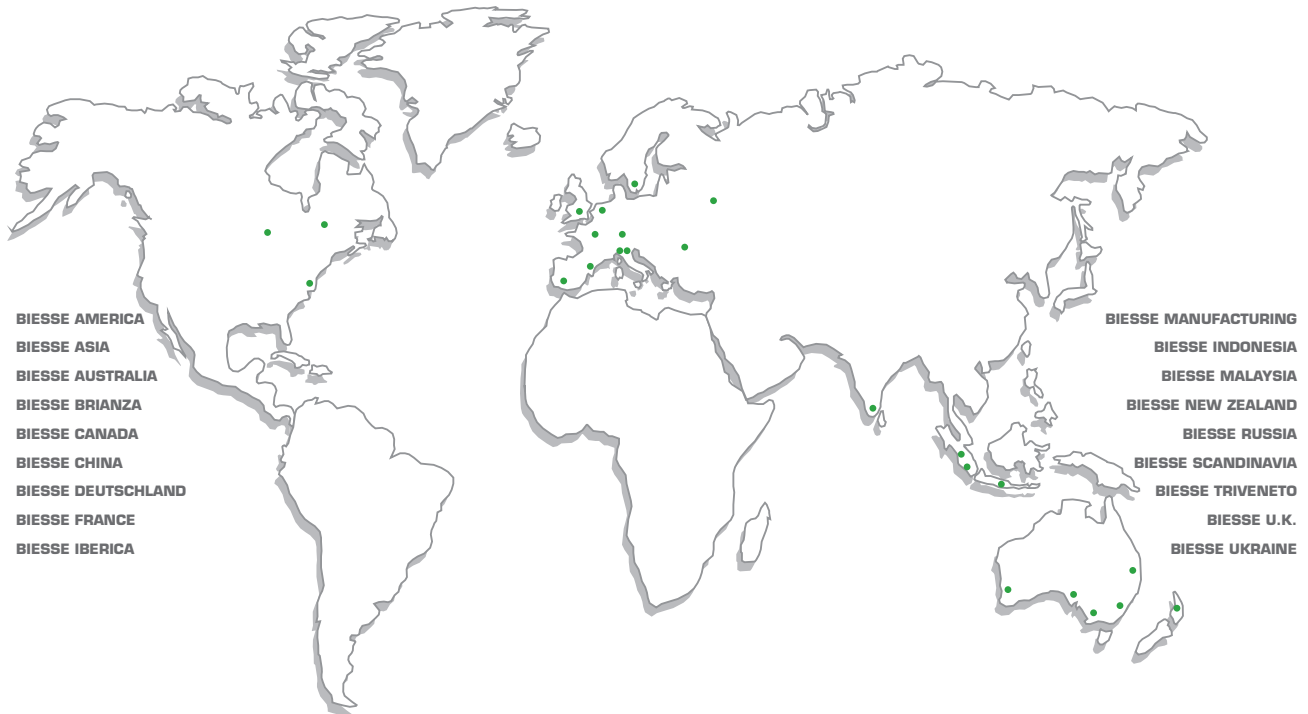

Il gruppo Biesse commercializza i propri prodotti attraverso una rete capillare di rivenditori e filiali localizzati nei mercati maggiormente industrializzati. Mediante questa rete Biesse garantisce ai propri clienti, in tutto il mondo, un'efficiente servizio di consulenza ed assistenza post vendita. Oggi il gruppo Biesse conta più di 2000 dipendenti ed una superficie produttiva di oltre 105.000 metri quadrati in Italia. Fin dalla sua costituzione, avvenuta nel 1969, il Gruppo Biesse si è contraddistinto sul mercato mondiale per la forte crescita e per la decisa volontà di divenire un partner globale per le imprese dei settori in cui opera.

The Biesse Group sells its products through a widespread network of dealers and subsidiaries, located in highly industrialized markets. It is through this network that the Biesse Group is able to grant worldwide professional advice and efficient after-sales service. At present the Biesse Group employs a worldwide staff of more than 2000 people and has production facilities in Italy with a total surface area of over 105.000 square metres. Starting right from its foundation in 1969, the Biesse Group has stood out in world markets for its rapidity of growth and strong will to become a global partner for those companies belonging to its lines of business.



Il gruppo Biesse è infatti strutturato in tre divisioni ciascuna delle quali si articola in unità produttive dedicate a singole linee di prodotto. La **Divisione Legno** sviluppa e produce macchine per l'industria del mobile e dei serramenti ed offre una gamma di soluzioni per l'intero ciclo di lavorazione industriale del legno e dei suoi derivati. Fornisce inoltre soluzioni di ingegneria ed impianti "chiavi in mano" ai clienti che devono risolvere complessi problemi di produzione, tecnologia e logistica. La **Divisione Vetro e Marmo** realizza macchine destinate alle aziende di trasformazione del vetro, marmo e pietre naturali e più in generale all'industria dell'arredamento, dell'edilizia strutturale e dell'automobile. La **Divisione Meccatronica** progetta e produce componenti tecnologicamente avanzati ad alta precisione sia per il gruppo che per il mercato esterno.

*The Biesse Group is made up of three divisions, each of which includes a productive unit concentrating on single product lines. It also supplies engineering solutions and "turn-key" plants to customers with complex demands relating to production, technology and logistics. The **Wood Division** designs and produces woodworking machinery for companies processing furniture, doors and windows, and offers a wide range of solutions for the entire industrial production cycle of wood and its by-products. The **Glass and Stone Division** produces machines for companies processing glass, marble and natural stone, and, more generally speaking, for different industries such as interior decoration, building and the automobile industry. The **Mechatronic Division** designs and produces highly technological components both for the Group and for the world market.*



Biesse in the World

BIESSE BRIANZA

Seregno (Milano)
Tel. +39 0362 27531_Fax +39 0362 221599
biessebrianza@biesse.it - www.biesse.com

BIESSE TRIVENETO

Codogné (Treviso)
Tel. +39 0438 793711_Fax +39 0438 795722
ufficio.commerciale@biessetriveneto.it - www.biesse.com

BIESSE DEUTSCHLAND GMBH

Elchingen
Tel. +49 (0)7308 96060_Fax +49 (0)7308 960666
Loehne
Tel. +49 (0)5731 744870_Fax +49 (0)5731 744 8711
info@biesse.de

BIESSE FRANCE S.A.R.L.

Brignais
Tèl. +33 (0)4 78 96 73 29_Fax +33 (0)4 78 96 73 30
commercial@biessefrance.fr - www.biessefrance.fr

BIESSE IBERICA WOODWORKING MACHINERY SL

L'Hospitalet de Llobregat, Barcelona
Tel. +34 (0)93 2631000_Fax +34 (0)93 2633802
biesse@biesse.es - www.biesse.es

BIESSE GROUP UK LTD.

Daventry, Northants
Tel. +44 1327 300366_Fax +44 1327 705150
info@biesse.co.uk - www.biesse.co.uk

BIESSE SCANDINAVIA

Representative Office of Biesse S.p.A.
Jönköping, Sweden
Tel. +46 (0)36 150380_Fax +46 (0)36 150380
biesse.scandinavia@telia.com
Service:
Tel. +46 (0)471 25170_Fax +46 (0)471 25107
biesse.scandinavia@jonstenberg.se

BIESSE AMERICA

Charlotte, North Carolina
Tel. +1 704 357 3131 - 877 8 BIESSE
Fax +1 704 357 3130
sales@biesseamerica.com
www.biesseamerica.com

BIESSE CANADA

Head Office
Terrebonne, QC
Tel. (800)598-3202- 877 8 BIESSE
Fax (450)477-0484
Showroom:
Terrebonne - Toronto - Vancouver
sales@biessecanada.com
www.biessecanada.com

BIESSE ASIA PTE. LTD.

Singapore
Tel. +65 6368 2632_Fax +65 6368 1969
mail@biesse-asia.com.sg

BIESSE INDONESIA

Representative office of Biesse Asia Pte. Ltd.
Jakarta
Tel. +62 21 52903911_Fax +62 21 52903913
biesse@indo.net.id

BIESSE MALAYSIA

Representative office of Biesse Asia Pte. Ltd.
Selangor
Tel./Fax +60 3 7955 4960
biessekl@tm.net.my

BIESSE TRADING (SHANGHAI) CO. LTD.

Subsidiary Office of Biesse Asia Pte. Ltd.
Shanghai, China
Tel. +86 21 5767 0387_Fax +86 21 5767 0391
mail@biesse-china.com.cn

BIESSE RUSSIA

Representative Office of Biesse S.p.A.
Moscow
Tel. +7 095 9565661_Fax +7 095 9565662
sales@biesse.ru - www.biesse.ru

BIESSE UKRAINE

Representative Office of Biesse S.p.A.
Kiev
Tel. +38 (0)44 5016370_Fax +38 (0)44 5016371

BIESSE GROUP AUSTRALIA PTY LTD.

Sydney, New South Wales
Tel. +61 (0)2 9609 5355_Fax +61 (0)2 9609 4291
nsw@biesseaustralia.com.au
www.biesseaustralia.com.au
Melbourne, Victoria
Tel. +61 (0)3 9314 8411_Fax +61 (0)3 9314 8511
vic@biesseaustralia.com.au
Brisbane, Queensland
Tel. +61 (0)7 3622 4111_Fax +61 (0)7 3622 4112
qld@biesseaustralia.com.au
Adelaide, South Australia
Tel. +61 (0)8 8297 3622_Fax +61 (0)8 8297 3122
sa@biesseaustralia.com.au
Perth, Western Australia
Tel. +61 (0)8 9303 4611_Fax +61 (0)8 9303 4622
wa@biesseaustralia.com.au

BIESSE GROUP NEW ZEALAND PTY LTD.

Auckland
Tel. +64 (0)9 820 0534_Fax +64 (0)9 820 0968
sales@biessenewzealand.co.nz

BIESSE MANUFACTURING COMPANY PVT LTD.

Bangalore, India
Tel. +91 80 22189801/02/03/04
Fax +91 80 22189810
sales@biessemnfg.com
www.biessemanufacturing.com
Mumbai, India
Tel. +91 22 28084401_Fax +91 22 28084401
Noida, Uttar Pradesh, India
Tel. +91 120 4280661/62/64_Fax +91 1204280663

Dati tecnici ed illustrazioni non sono impegnativi. Alcune foto possono riprodurre macchine complete di opzionali. Biesse Spa si riserva il diritto di apportare eventuali modifiche senza preavviso.

The proposed images and technical data are only indicative. The illustrated machines may be equipped with optional devices. Biesse Spa reserves the right to carry out modifications to its products and documentation without prior notice.

www.biesse.com