

K - KH - KP

SERIE K - KH - KP

CALIBRATING MACHINES

CALIBRATRICI



 **COSTA**
LEVIGATRICI

USA I



Heavy-duty high-speed top calibrating finish sanding line, with full sound protections to dB 80, air return system, automatic re-setting control to hold thickness tolerance on work pieces.

Linea superiore pesante per calibrare e finire ad alta velocità, con protezioni acustiche a 80 dB, sistema di recupero con ritorno in macchina dell'aria aspirata, sistema automatico di recupero delle tolleranze di spessore dei pezzi levigati.

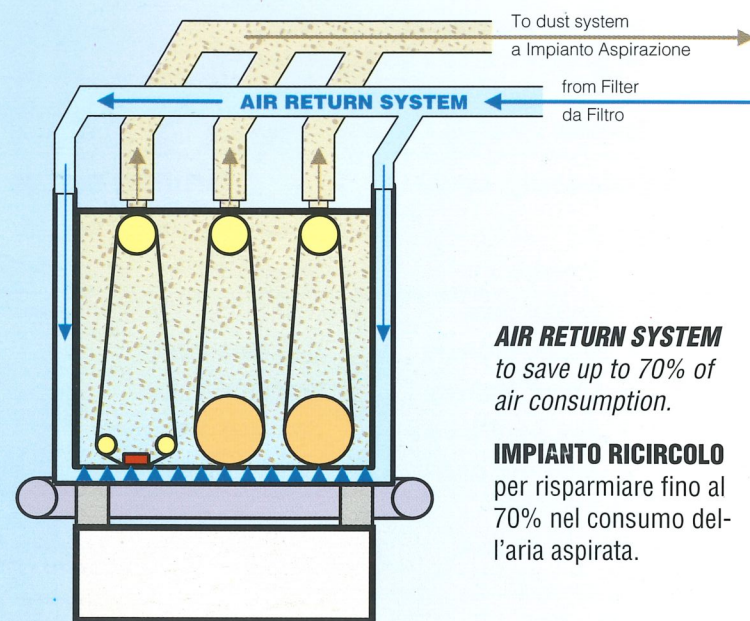

AIR RETURN SYSTEM to save up to 70% of air consumption.

IMPIANTO RICIRCOLO per risparmiare fino al 70% nel consumo dell'aria aspirata.

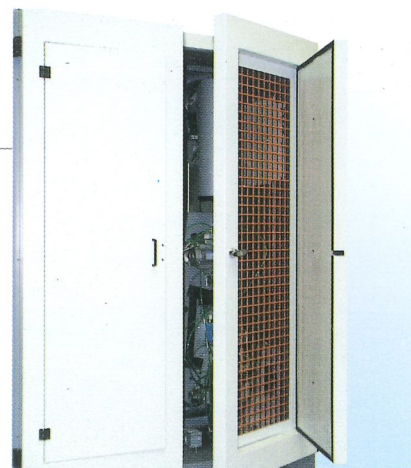

Double doors (optional on KH/KP) the external with noise protections and the inside made with a net, with emergency safety stop when opening the inside.

Porte doppie (opzionali su KH/KP) l'esterna cieca con protezioni acustiche e l'interna a rete, con emergenza attivata all'apertura della porta interna.



Motors of working units available with power up to kW 90 each, with disk brakes for emergency stop. Optional is the sound protection cabin to dB 80/82 with special air intake for cooling the motors.

Motori dei gruppi operatori disponibili con potenze fino a kW 90 caduno, con freni a disco per stop di emergenza. Opzionale la cabina di protezione acustica a dB 80/82 con prese di aerazione per raffreddamento dei motori.

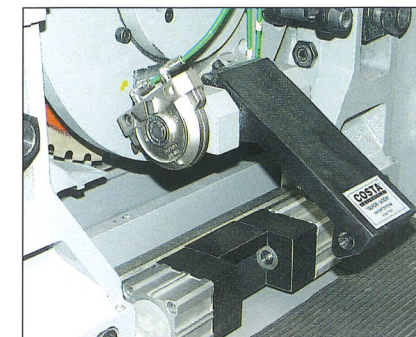
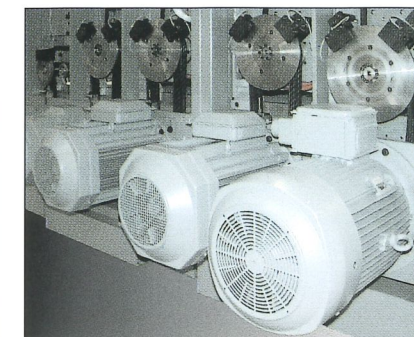

Quick-Lock (optional) automatic locking of working unit to the frame (for easy sanding belt change).

Quick-Lock (opzionale) bloccaggio automatico del gruppo operatore alla struttura (per facilitare il cambio dei nastri abrasivi).

PRESSURE UNITS

Our pressure units are a solid construction with "lips" to hold workpieces closer to the working units, with a variable pressure system with heavy springs or a pneumatic system.

The pressure unit include a set of rubber covered rollers, totally adjustable with an eccentric system of re-setting the levels (right-left).

GRUPPI PRESSOI

Il gruppo pressorio è costruito in acciaio o ghisa con puntali di accompagnamento pezzi fin sotto il gruppo operatore, con un sistema di pressione tarabile con molle a tazza o con sistema pneumatico.

Il gruppo comprende un set di rulli di scorrimento gommati, con aggiustamento ad eccentrico dei livelli (destra-sinistra) del livello di lavoro.

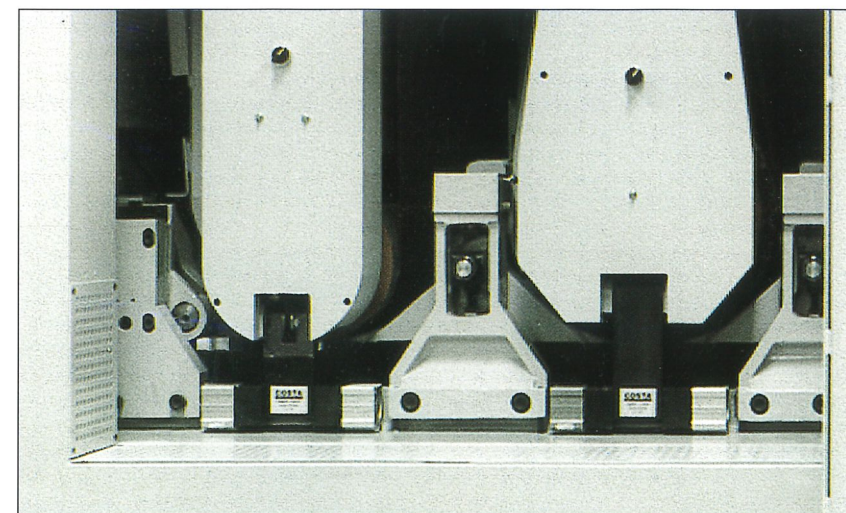

Infeed pressure unit with "lips".

Pressorio a puntale in entrata.

Intermediate pressure unit with "lips".

Pressorio a puntale intermedio.

Infeed pressure unit with "sectioned lips", with variable pressure (optional).

Pressorio a puntale in entrata sezionato, con pressione variabile (opzionali).

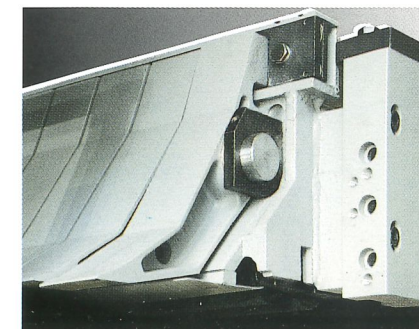

FEED TABLES

with holes for vacuum plant

Standard Feed tables

The heavy calibrating machines require an absolutely rigid feed table to assure the accuracy of the workpieces during the calibrating process, feed table hard enough to assure the precision for the (many) years of utilization.

Our feed tables are made in solid steel sheets type T1 (hardness 300 Brinell), grinded to a very fine rugosity level (see notes) to an accuracy of surface flatness of mm +/-0.025.

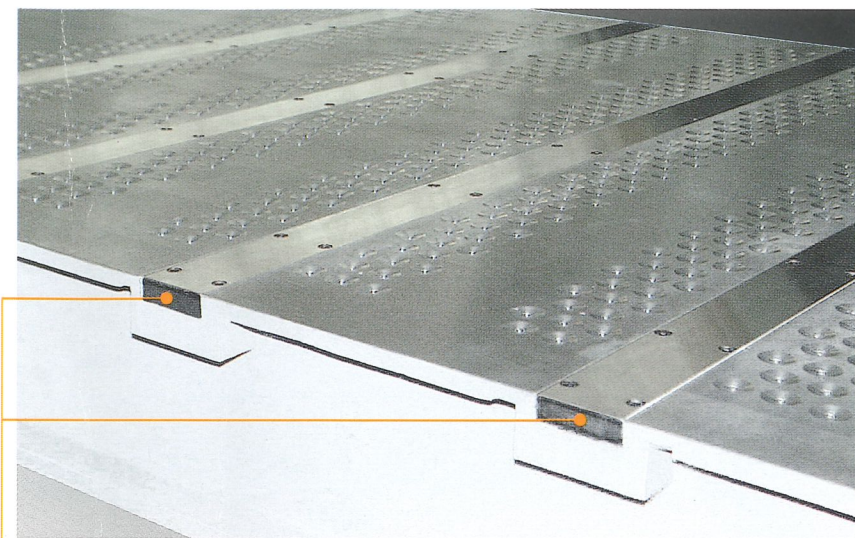

Hardened steel inserts interchangeable (optional), suggested for heavy-duty operations and in high speed machines, possible the water cooling system of inserts to hold precision.

Inserti in acciaio cementato intercambiabili (opzionali), consigliati per operazioni di calibratura pesanti e con alte velocità di avanzamento, con possibilità di raffreddamento a liquido per mantenere la precisione.

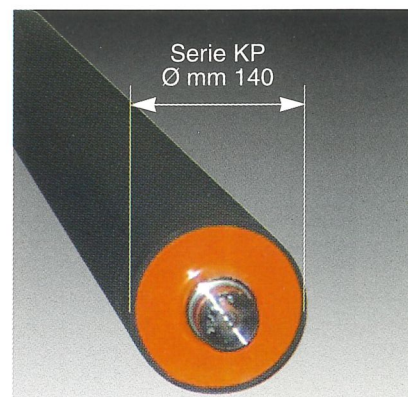
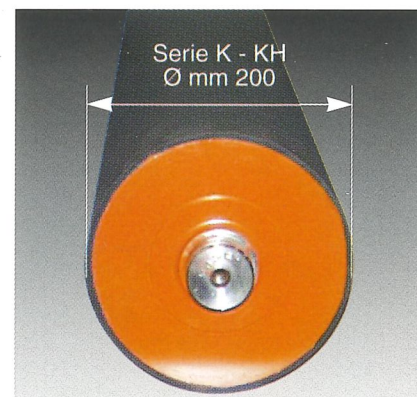
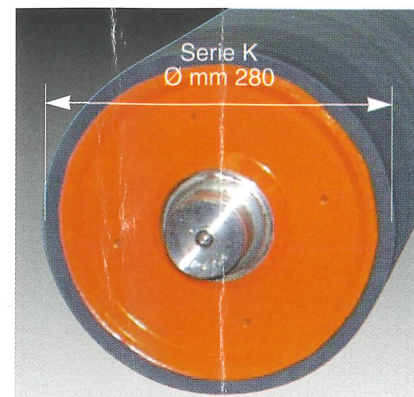

Rubber covered traction rollers of appropriate diameter on each Serie, depending on the power of the calibrating motors; for high power (and high feed speed) we recommend larger diameter rollers for higher traction surface on the feed belt.

Rulli di trazione gommati di diametro appropriato per ciascuna Serie, a seconda delle potenze installate dei motori operatori; per alte potenze (e alte velocità) consigliamo i diametri più elevati per una superficie di contatto/trazione più vasta sul tappeto di avanzamento.

TAVOLE AVANZAMENTO

con foratura per depressione

tavole avanzamento standard

Le calibratrici pesanti necessitano di un banco di avanzamento molto rigido per ottenere la (alta) precisione dei pezzi da calibrare, tavole anche molto dure per assicurare la precisione per gli anni di utilizzo della macchina. Le nostre tavole sono costruite con lamiere in acciaio anticonsumo T1 (durezza 300 Brinell), con superfici rettificate fino a bassa rugosità (vedi note) per assicurare tolleranze di planarità a mm +/-0.025.

Rugosity of GRINDED feed tables:

▼▼▼ = 0,8 micron equal to 20.000 hours of lasting time.

Note: Rugosity of PLANED feed tables:

▼▼ = 3,2 micron equal to 6.000 hours of lasting time.

Rugosità tavole RETTIFICATE:

▼▼▼ = 0,8 micron pari a 20.000 ore di durata.

Nota: Rugosità di tavole PIALLATE:

▼▼ = 3,2 micron pari a 6.000 ore di durata.

ELECTRONIC CONTROLLED AUTOMATIC FEED SPEED ADJUSTMENT

(in relation to power utilization of motors of working units) – optional

Working way: during function the power consumption is constantly monitored.

Upon approaching the highest allowed value, corresponding to the max. take away volume of the sanding belt with the available power at speed F, the PLC automatically increases or slows down the feed speed, until the power absorption goes back to the limit allowed (90-95% of the available power).

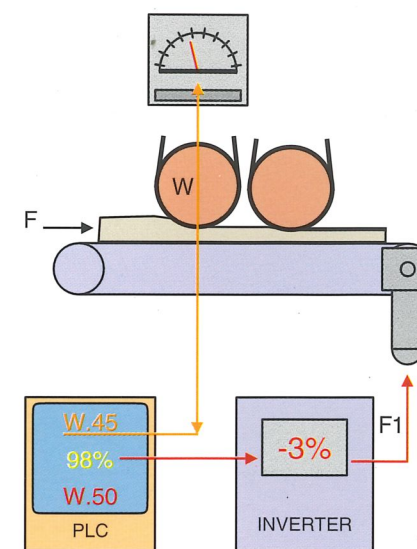

F = Entered speed.
F1 = Actual speed.
W = Measurement of absorption of working motor.
PLC = Electronic box of working parameter.

SISTEMA ELETTRONICO DI CONTROLLO AUTOMATICO DELLA VELOCITÀ DI AVANZAMENTO

(in funzione del carico di potenza dei motori dei gruppi operatori) – opzionale

Modo di funzionamento: durante la lavorazione, viene misurato in continuo l'assorbimento del primo motore operatore.

All'approssimarsi del valore di massimo assorbimento di potenza, corrispondente al volume massimo di asportazione con la potenza disponibile alla velocità di avanzamento impostata F, il PLC di controllo automaticamente aumenta o diminuisce la velocità di avanzamento, fino a ripristinare il valore di assorbimento elettrico del motore (pari al 90-95% della potenza disponibile).

F = Velocità impostata.
F1 = Velocità reale.
W = Misurazione assorbimento motore operatore.
PLC = Centralina elettronica dei parametri di impostazione.

Feed drive unit is always inverter controlled, in bigger machines is linked with a cardan joint to the traction roller.

Gruppo motoriduttore avanzamento è sempre controllato da inverter, nelle macchine più grandi il moto è trasmesso al rullo di trazione tramite giunto cardano.

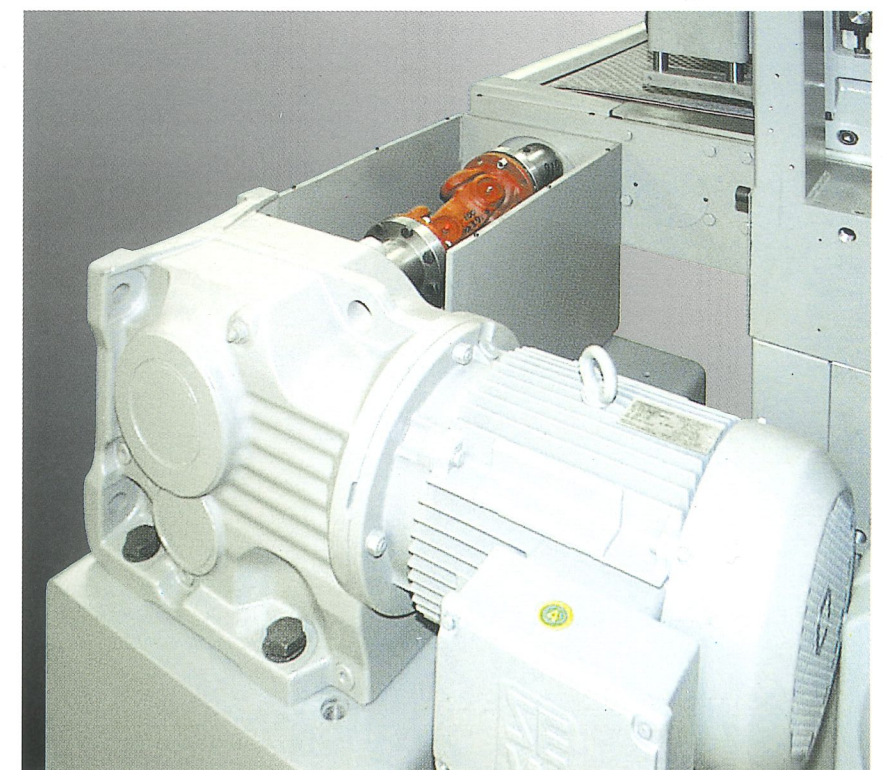



Serie K - KH - KP

K

Serie K heavy duty calibrating-sanding top machines with 1 to 6 longitudinal working units in sanding belt length mm 2620 or 3250/4600 (optional), with possibility to utilize motor power up to kW 90 in each working unit.

* the sound protections on the base and cleaning units on pictures, are an option.

Serie K macchine calibratrici-levigatrici pesanti a gruppi superiori con 1 fino a 6 gruppi operatori longitudinali con sviluppo nastri abrasivi da mm 2620 o 3250/4600 (opzionali), con possibilità di impiegare motori di potenza fino a kW 90 cada unità.

* la copertura di protezione acustica dei basamenti e gruppi pulizia fotografati, sono opzionali.

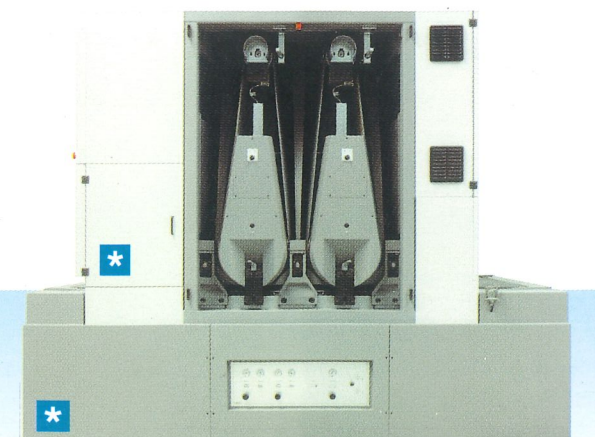
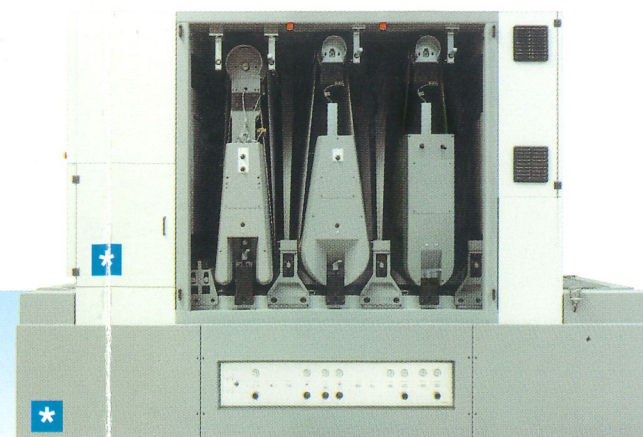
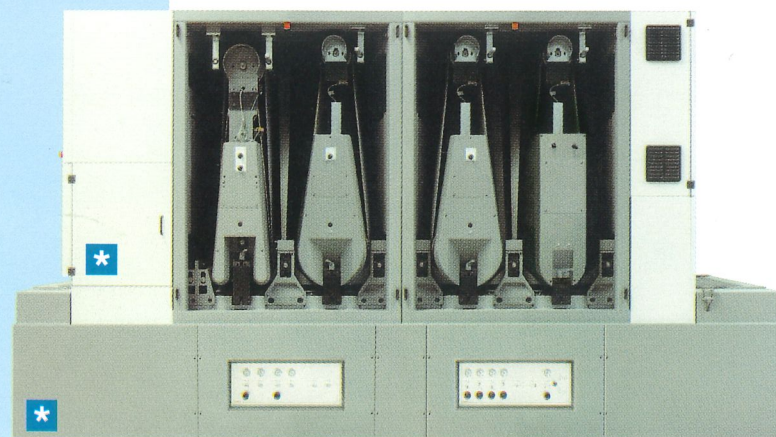
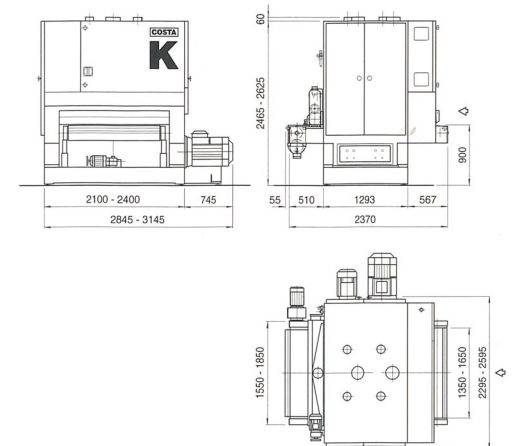
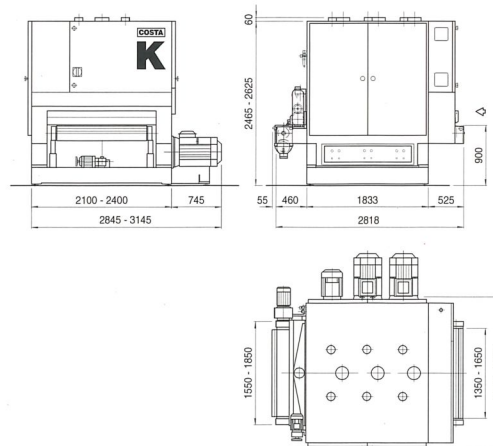
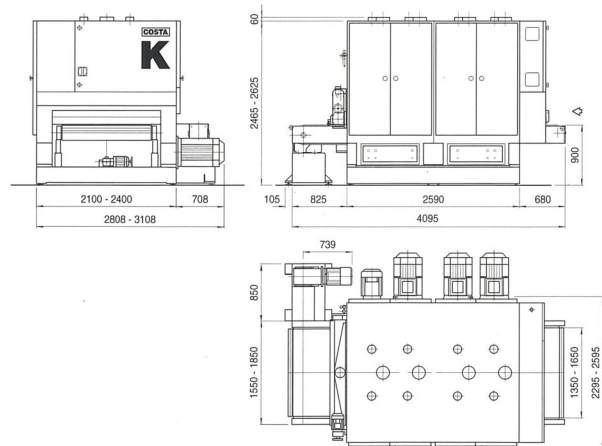
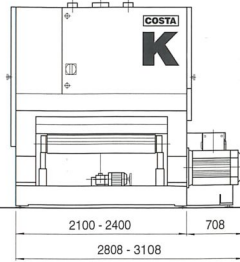
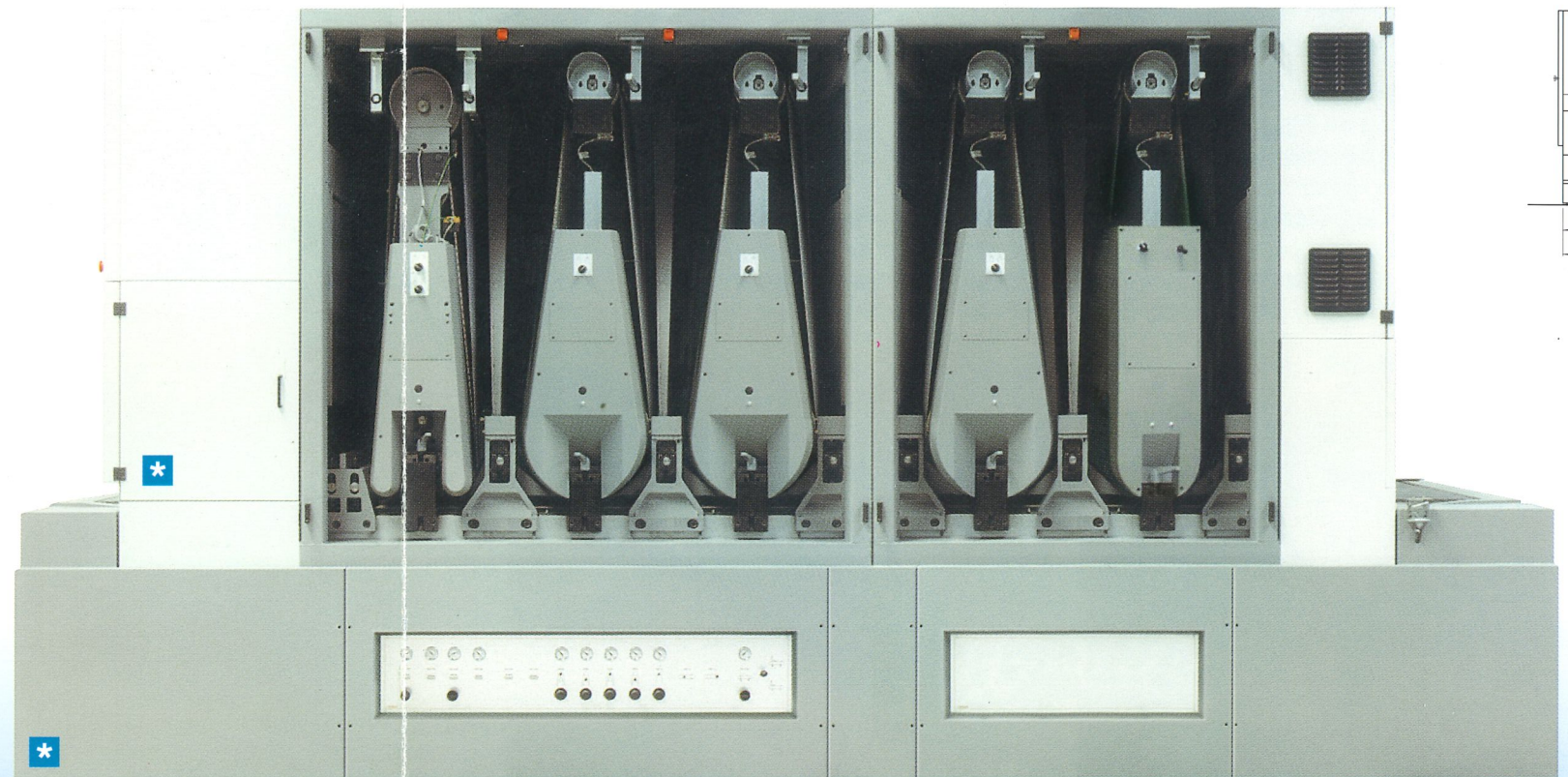



Serie K - KH - KP

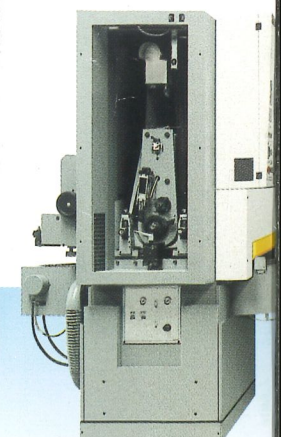
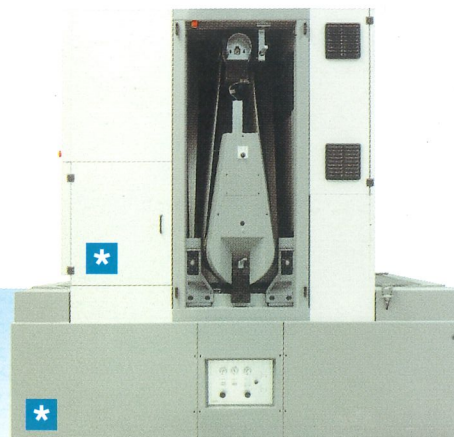
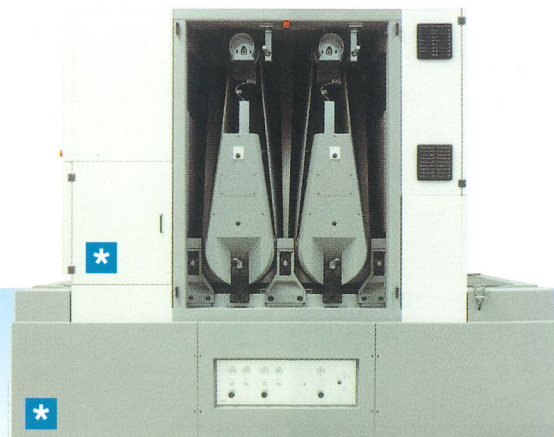
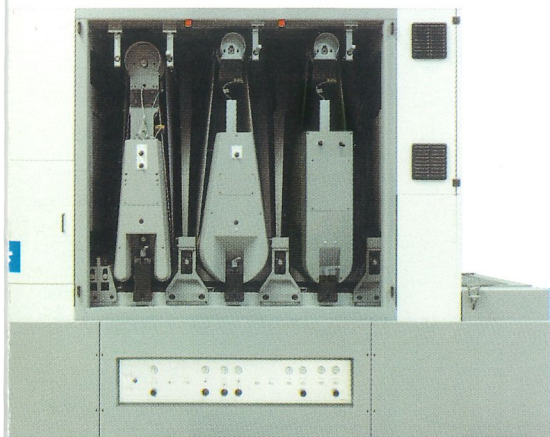
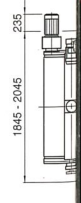
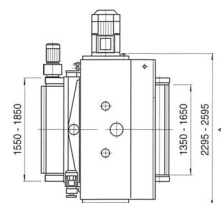
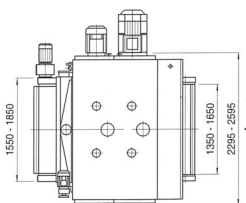
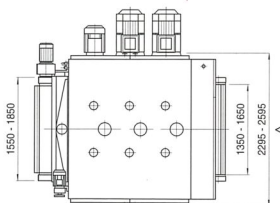
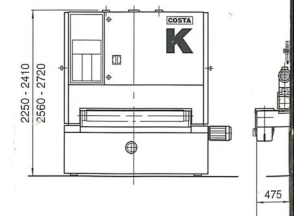
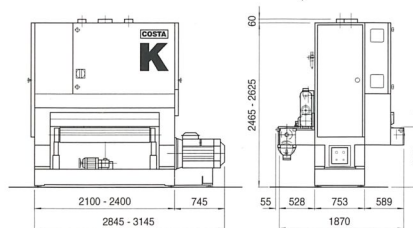
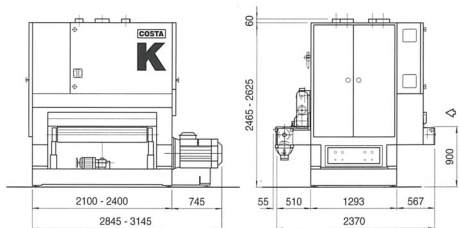
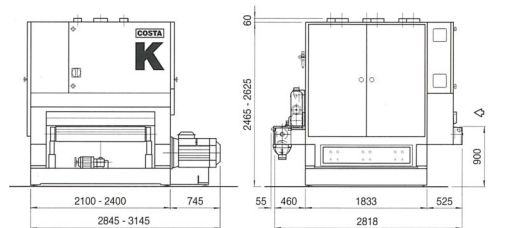
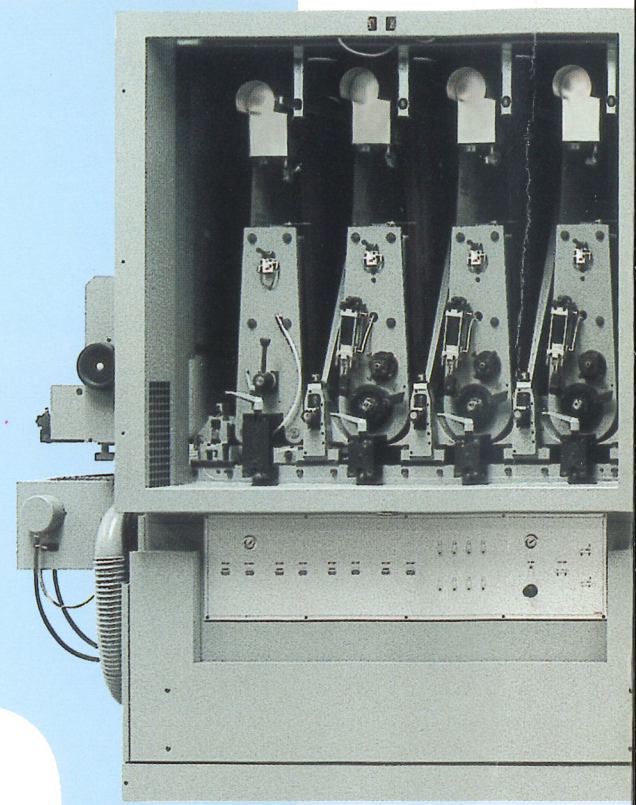
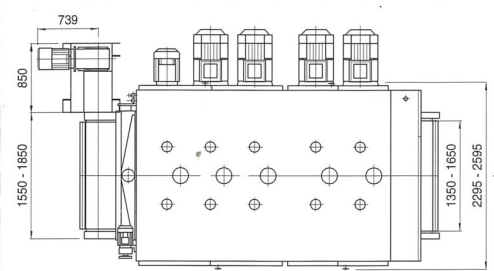
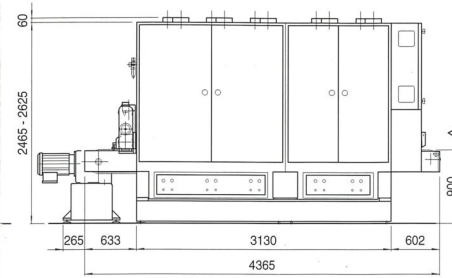
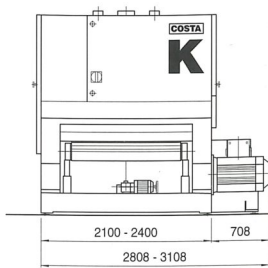
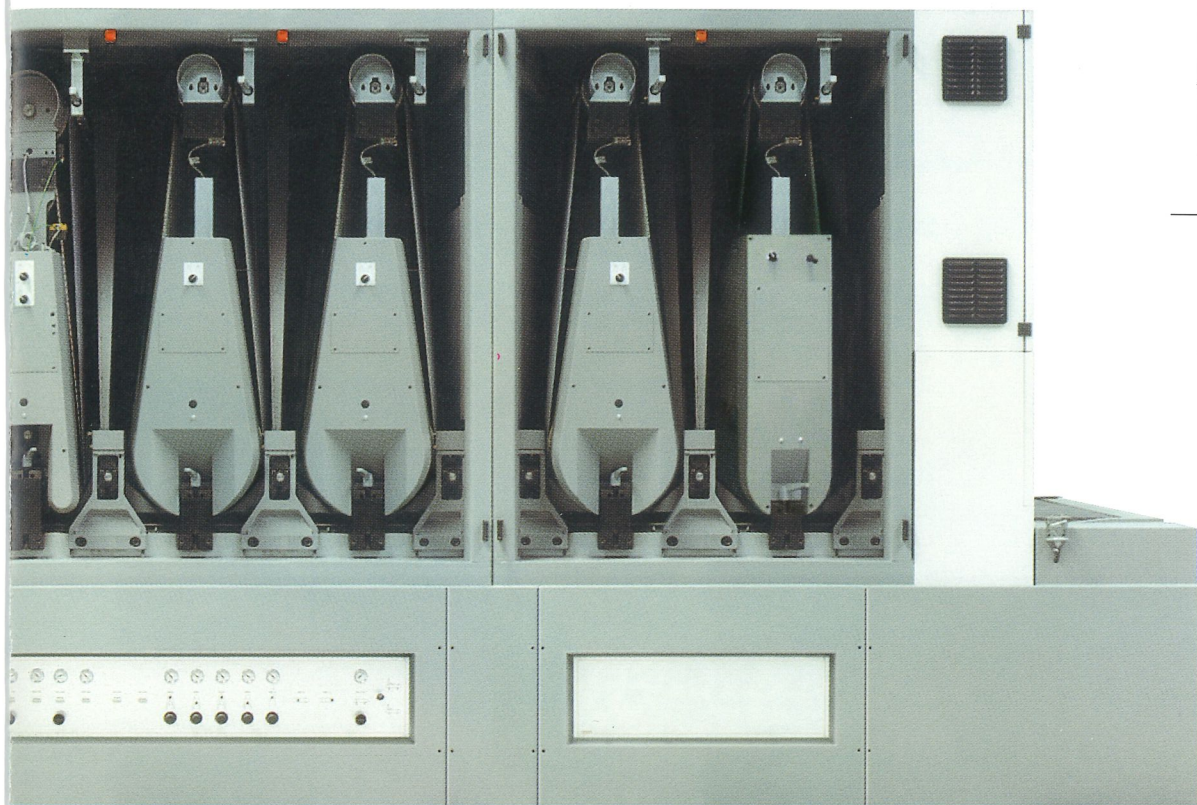

KH



Serie K - KH - KP

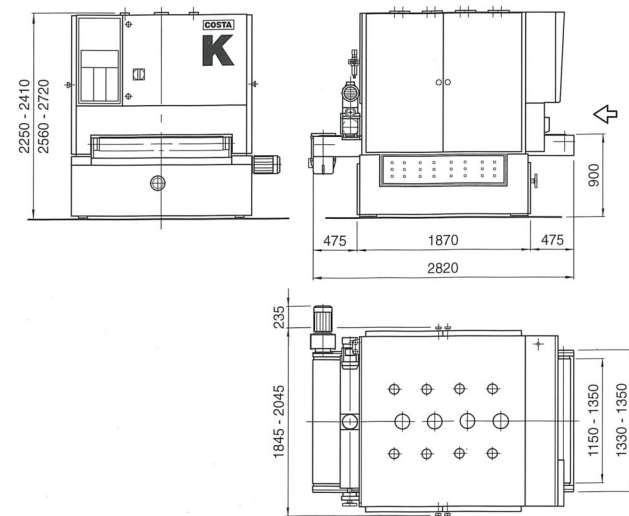
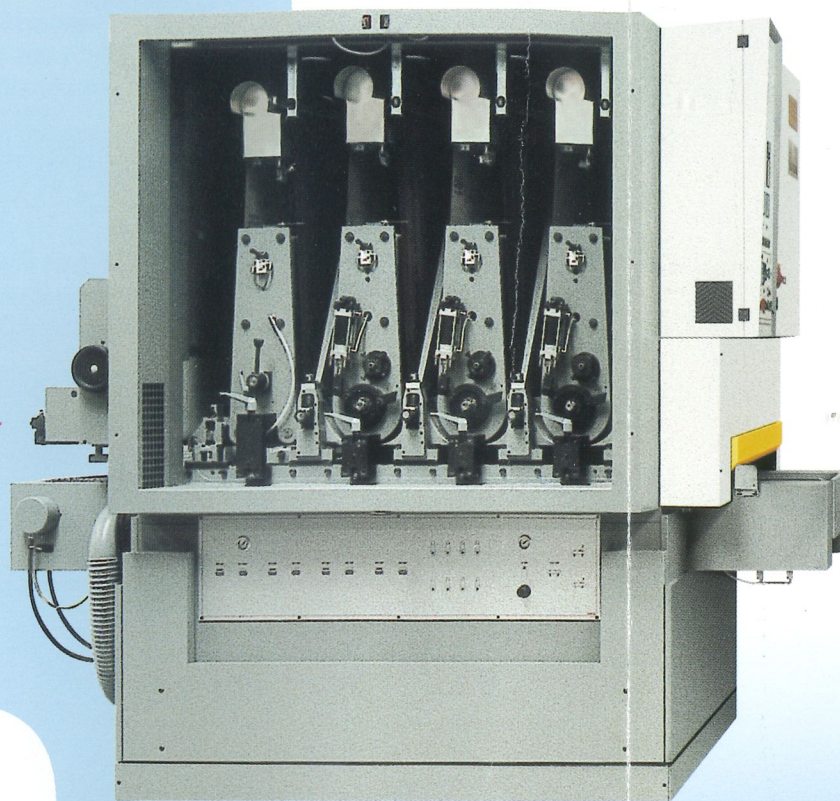
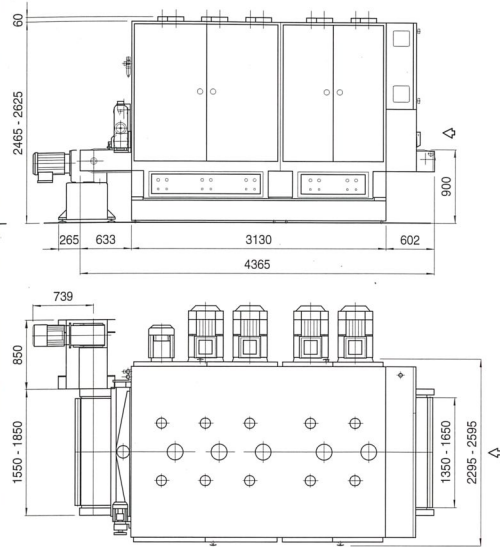

Serie KH top calibrating-sanding machines with 1 to 4 longitudinal working units in sanding belt length mm 2620 or 3250 (optional) with possibility to utilize motor power up to kW 45 in 1st position. Version particularly suitable for processing very short work pieces.

Serie KH calibrati-levigatrici superiori con 1 fino a 4 gruppi operatori longitudinali con sviluppo nastri abrasivi da mm 2620 o 3250 (opzionale), con possibilità di impiegare motori di potenza fino a kW 45 in 1^a posizione. Versione compatta particolarmente studiata per lavorare pezzi molto corti.

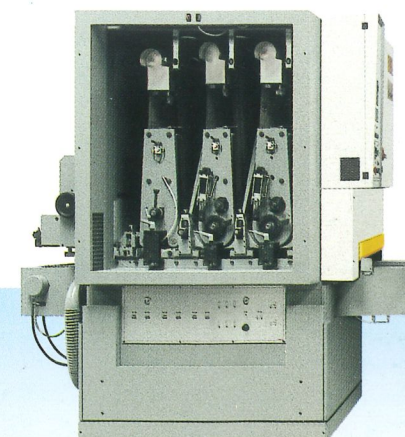
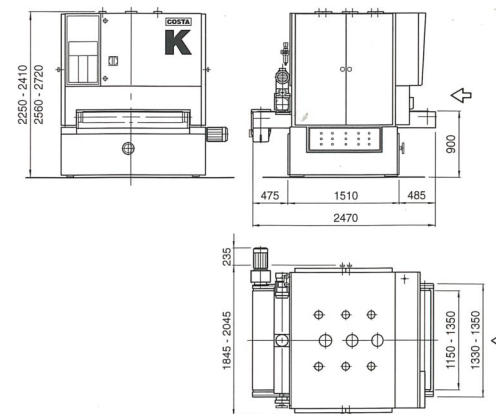
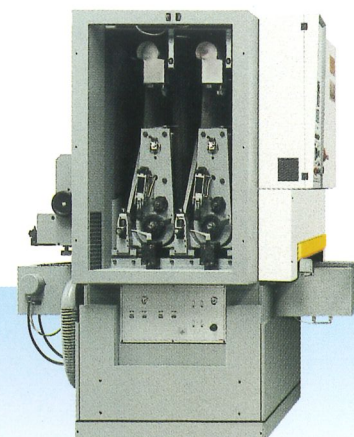
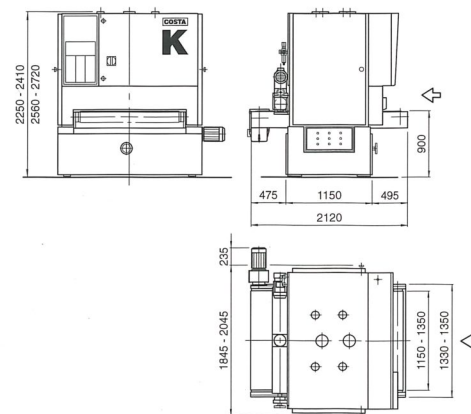
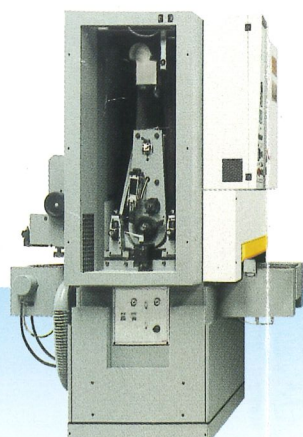
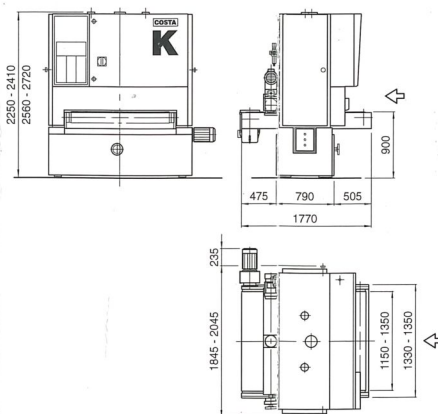
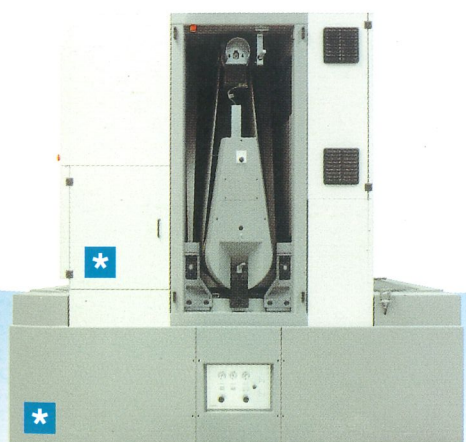
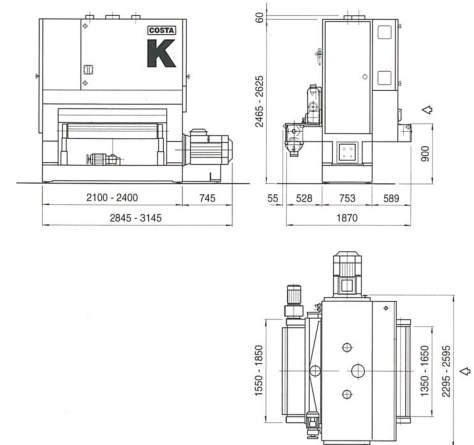

KH

working units gruppi di lavoro

SERIE K - KH - KP

	Normal working width Larghezza di lavoro normale	mm 1350
	Special working widths Larghezze di lavoro speciali	mm 350÷2500
	Standard machine opening Spessori lavorabili standard	mm 0/160
	Optional machine opening Spessori lavorabili opzionali	mm 0/250
	Constant pass line from floor Piano di lavoro ad altezza costante	mm 900/1000

Longitudinal sanding belt length

Note: cross belt units on request.

Sviluppo dei nastri abrasivi longitudinali

Nota: gruppi trasversali applicabili a richiesta.

mm 2620

mm 3250

Cylinder units

Gruppi cilindro

C 250 Steel or rubber covered / Acciaio o gommato	Ø mm 250
C 330 Rubber covered / Gommato	Ø mm 330
C 400 Steel or rubber covered / Acciaio o gommato	Ø mm 400

Pad working units

Gruppi tampone

T1 Pneumatic pad with timed entry electronic Gruppo tampone pneumatico con entrata a tempo elettronica	P. mm 1350 n. 1 / 1350
TP32 Sectioned pad with electronic control Tampone sezionato a controllo elettronico	P. mm 32 n. 42 / 1350
TP16 Sectioned pad with electronic control Tampone sezionato a controllo elettronico	P. mm 16 n. 84 / 1350

Panel cleaning units

Gruppo pulizia pannello

S180 - Brushes	Spazzole	Ø mm 180
SB180 - Scotch Brite		Ø mm 180
SR - Rotary Blowers	Soffiatori rotanti	
SL - Linear Blowers	Soffiatori lineari	
SJ - Jonizing Blowers	Soffiatori Jonizzanti	
AB - Antistatic bars	Barre antistatiche	

COSTA LEVIGATRICI S.p.A.
Direzione: Via Venezia, 144 - 36015 Schio (VI) Italy
Tel. (+39)0445-675000 - Fax (+39)0445-675110
Internet: www.costalev.com - E-mail: info@costalev.com

We reserve the right to change features without any notice.

Con riserva di apportare modifiche senza obbligo di preavviso.

COSTA
LEVIGATRICI