

Nesting with 3-, 4- or 5-axis technology.

HOMAG

Our CNC-Gantry Processing Center
CENTATEQ N-600

YOUR SOLUTION







The CENTATEQ N-600 can handle anything – except edging!

Our CNC processing centers today already offer technology of the future. And with good reason: Tradition. »Made in Germany« is our motivation and our commitment. Customers the world over associate this quality seal with the very highest standards. And we meet those expectations.

The typical application areas of nesting:

- Creating components for carcass furniture
- Dividing and refining of furniture fronts
- Processing of frame furniture
- Creating components for the caravan sector and structural-facings sector
- Various possibilities for the automation of the material handling ensure a high time saving and more effective work.

MORE: HOMAG.COM



CENTATEQ N-600

CONTENTS

04	Highlights of the CENTATEQ N-600
08	All inclusive
10	Options
12	Processing unit technology
14	Handling solutions
16	Setting Cabineo connector
17	Robot Connection
20	Everything at a glance
22	powerTouch2
24	intelliDivide cabinetCreator
26	Option Process optimization
28	tapio
32	Technical Data
34	Life Cycle Services

CENTATEQ N-600 – The compact nesting machine in gantry design

Our nesting machines enable cutting-optimized processing and dividing of plateshaped materials. We divide the typical nesting areas into four areas. The classic areas of nesting can be divided into carcass processing, cutting and finishing of furniture fronts, processing for modular furniture production as well as “advanced materials” (e.g. Plexiglas, aluminum, Alucobond). Various possibilities for the automation of the material handling ensure a high time saving and more effective work.

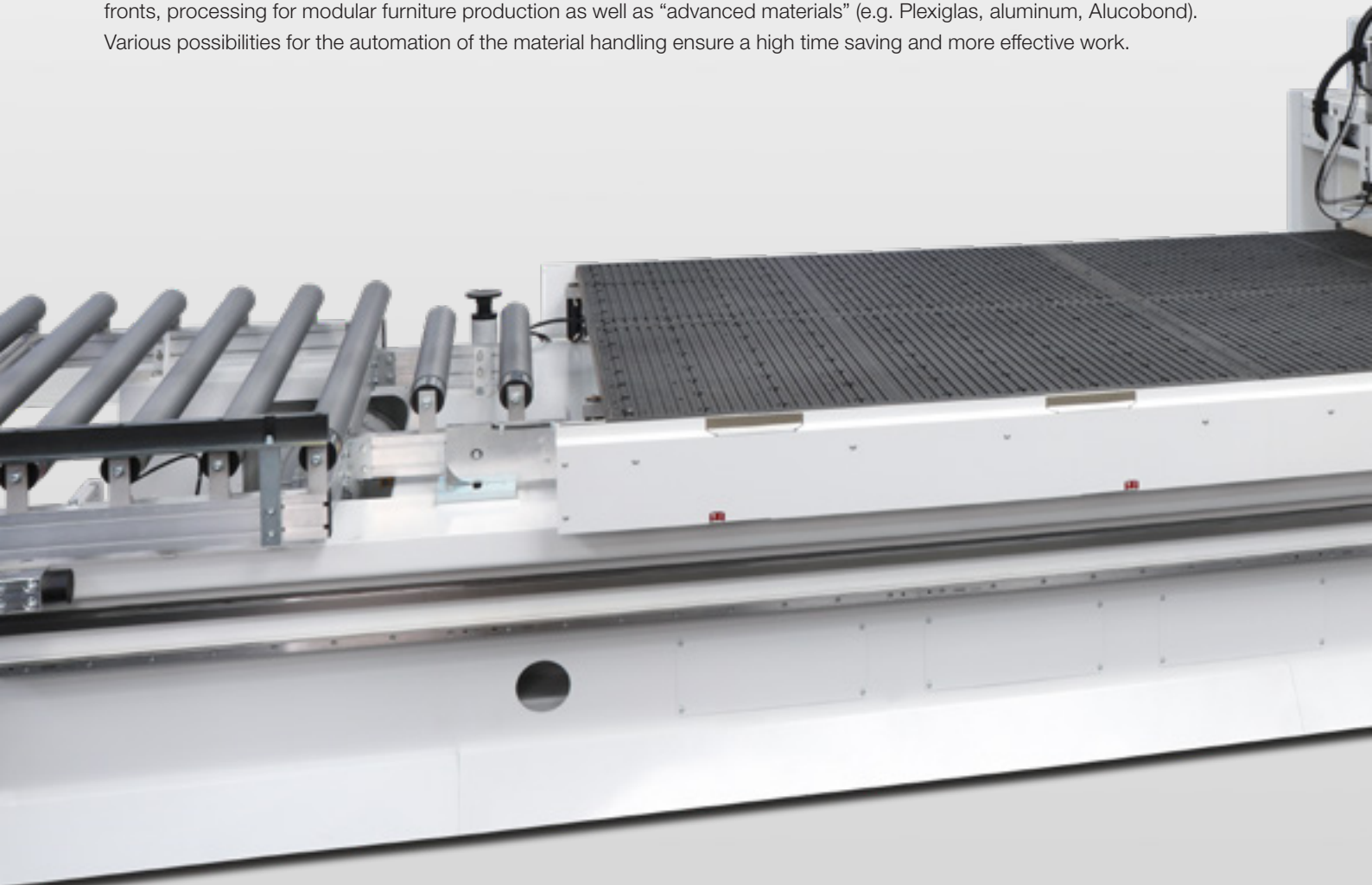

Advantages of the CENTATEQ N-600:

- 7 levels of automation enable a perfect production process
- 3-, 4- or 5-axis processing for your entire processing portfolio
- Everything in a single machine: nesting and hardware insertion
- Intelligent optimization software such as intelliDivide and Cut Rite
- Labeling/workpiece identification

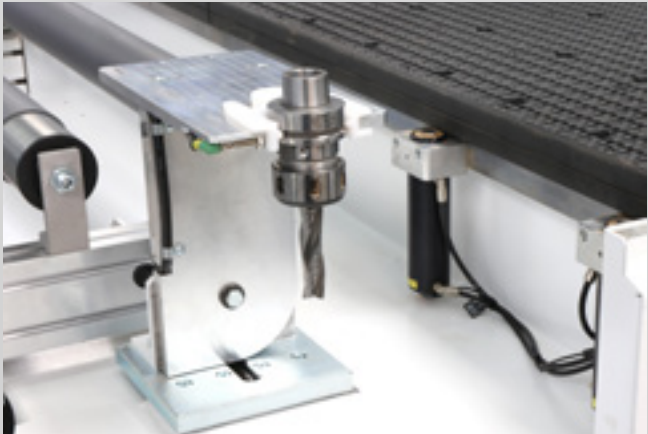
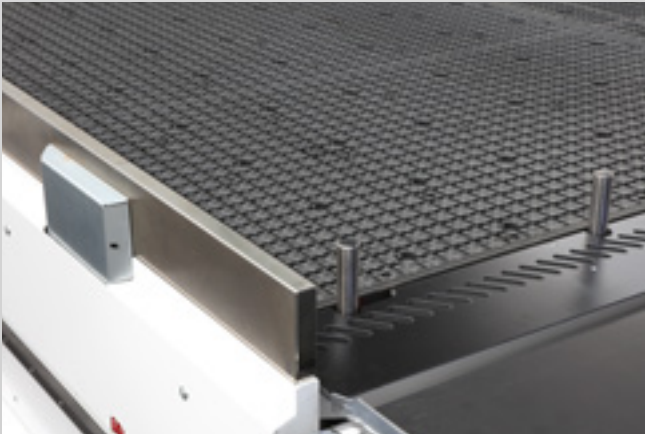

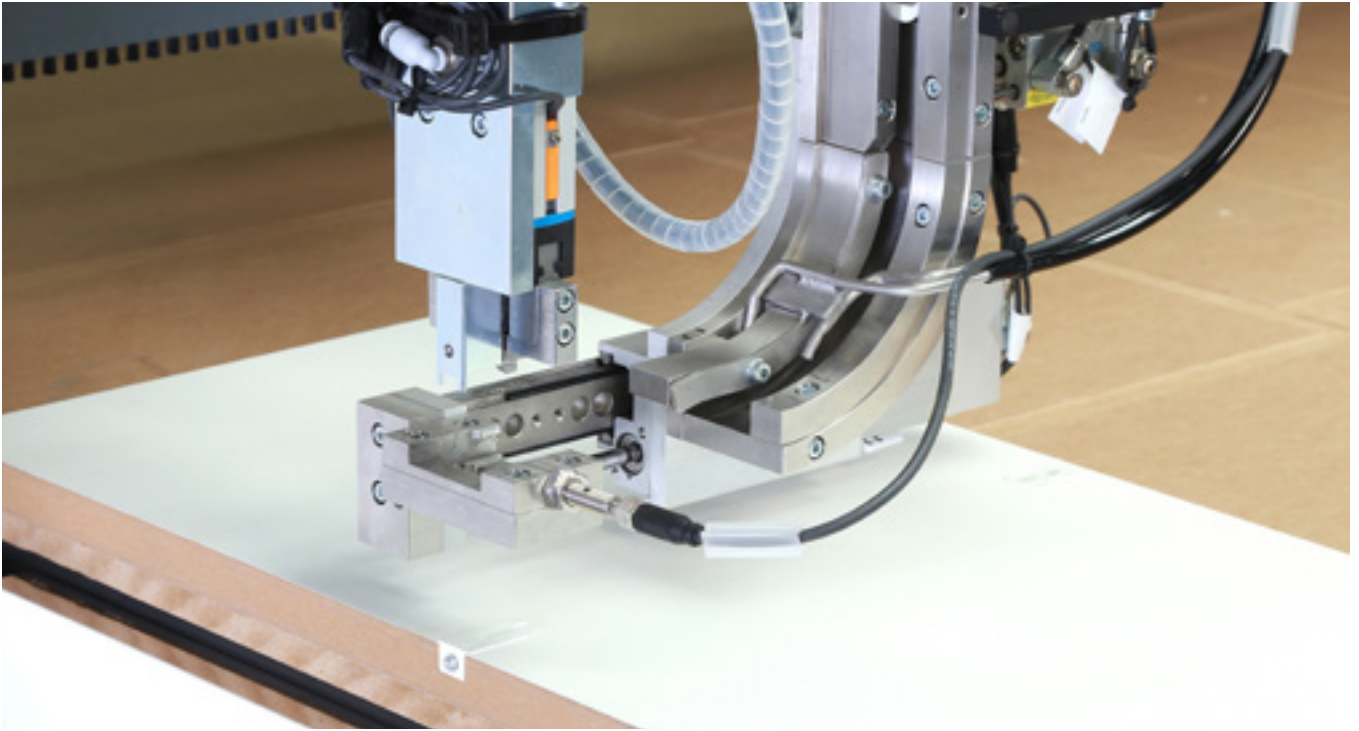

Insertion technology meets CNC processing center

Selling over 100 drill and insertion machines every year, HOMAG leads the market with expertise in inserting different connectors, fixtures or hinges into panel-shaped materials. We put this experience to use in CNC processing centers and offer a combination of drilling, trimming and insertion in a single machine.



CENTATEQ N-600 – taking these new features into the future

Our machines offer a wide range of options. With 7 levels of automation, 3-, 4- or 5-axis processing with different performance levels, various high-speed drilling gears and the positioning of flush connectors, nothing is left to be desired. Simply ask us and we will develop a tailored solution for you.



Which connector technology do you work with?

The new 5-axis technology with unit interface or our tried-and-tested 4-axis unit with Flex 5 interface make it possible to produce miter cuts and, for example, Clamex processing in a reliable and precise process.



DRIVE5CS with unit interface

The smart DRIVE5CS 5-axis head – compact design with short force paths. A lot of technology in a small space with no processing limitations. Liquid-cooled spindles with 10 kW (optional 12 kW trimming power) for high-power work. The short design creates more space for processing (e.g. with a 350 mm saw blade).



IntelliDivide – optimized plate layout

Along with the optimization of panel dividing saws, the latest online optimization is now available for the nesting machine at all times. HOMAG lets you use the same software package for different machines.



New labeling terminal on outfeed conveyor

To improve the efficiency of manual labeling and stacking on the outfeed transport conveyor, we now offer an ergonomic and mobile system.



Labeling made easy

Individual labels can be reprinted if required.



Robotized destacking

Do you need things to be more automated? With the new control system and data structure, you can upgrade your machine gradually, right up to the point of 100% automated production.

CENTATEQ N-600 – Highlights as standard

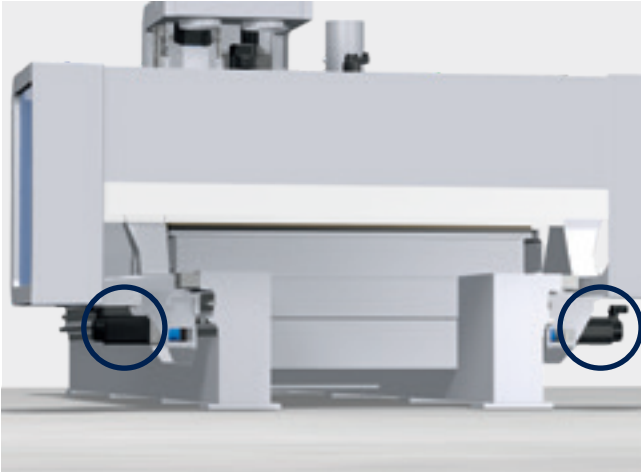

Synchronous drive

- 2 synchronized digital servo-drives in X-direction guarantee highest processing quality



Tool pick-up station

- Folding transfer station at the front of the machine for efficient set-up

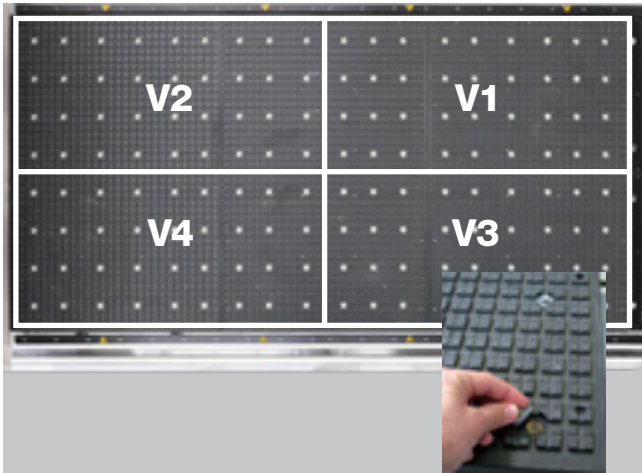

MATRIX table PRO

- High flexibility
- Segmentation of the vacuum zones into four equally sized fields
- With grid grooves for clamping of templates or workpieces. Grid grooves for inlaying of a rubber sealing.
- Customer-specific segmentation is also possible.



Tool changing system

- 14-fold tool changer moving in X-direction
- Tool pick-up station

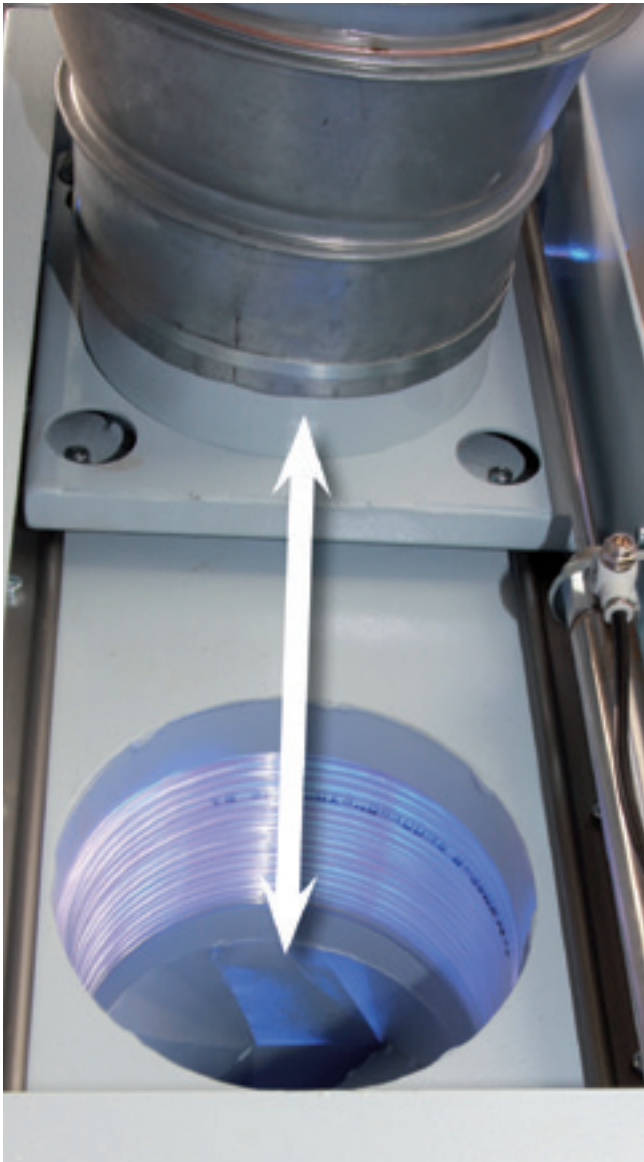

Program-controlled extraction connection

- For an optimum dust extraction and economic use of extraction energy (ecoPlus)

Other highlights

- Sealed »long-life« linear guiding system
- High acceleration
- Vector speed X/Y 130 m/min
- The whole working field is reachable with all processing tools
- Electronic surveillance of all stops
- Efficient use of energy through high vacuum performances and simultaneously minor power consumption

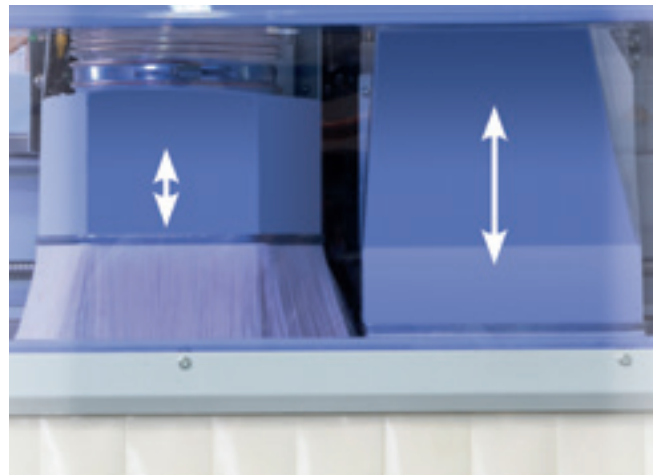

2 CNC-controlled Z-axes in combination with drilling block

- Optimal dust extraction and bigger operative range for processing units
- Weight distribution of the mass (processing units) to the two Z-axes = more stability, higher processing quality

Options

WOULD YOU LIKE SOMETHING EXTRA? Our options provide all opportunities for a perfect adjustment of your nesting machine to your requirements.



Choose your processing unit

- Routing spindle (10 or 13.2 kW)
- C-axis with flex5 interface
- DRIVE5CS with vibration sensor and unit interface

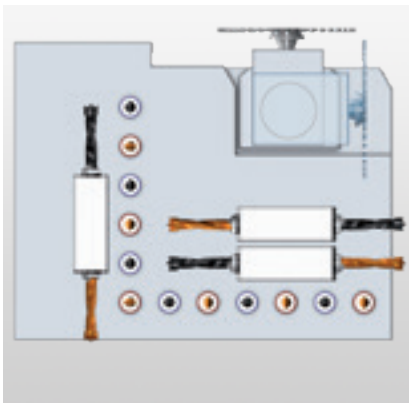

High-Speed 7500 Drilling block | 12 spindles

- 12 vertical drilling spindles
- 4 horizontal drilling spindles in X
- 2 horizontal drilling spindles in Y
- 1 Grooving saw Ø 125 mm (0° / 90°)

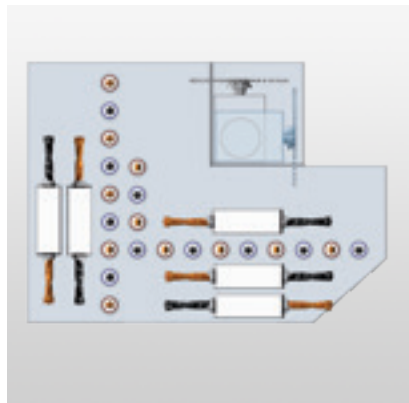

High-Speed 7500 Drilling block | 21 spindles

- 21 vertical drilling spindles
- 6 horizontal drilling spindles in X
- 4 horizontal drilling spindles in Y
- 1 Grooving saw Ø 125 mm (0° / 90°)



High-Speed 7500

- Spindles with 1500 - 7500 RPM incl. the patented quick change system



Vacuum lever for raw panel positioning

- For automatic positioning of the raw panels against the fence guide



Additional tool change system

- Piggyback tool change system in X-direction. 14 or 28 slots are available depending on requirements.

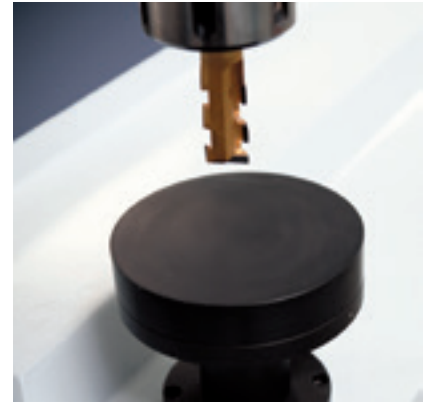

Tool length control

- Following the tool change a tool length control is carried out and compared with the integrated tool data file

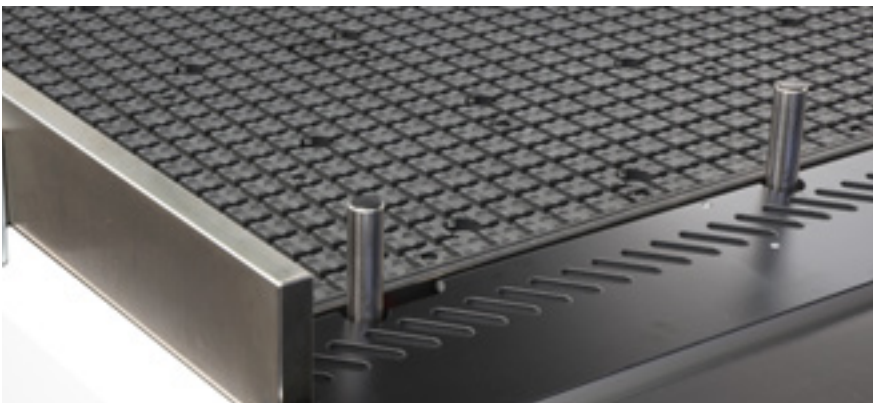

Extension alignment system – the choice is yours

- Aluminum stop cylinder can be lowered pneumatically for individual operation
- Stop fence can be lowered for a high level of automation
- Raised stop fences can be lowered for five-axis processing or automation



Lowerable fence guide

- Suitable for safe outfeed of workpieces



Clamping elements

- Different clamping elements available as option



Tool box »STARTER KIT«

- Top equipment – from the very start



Barcode connection

- Barcodescanner / -software
- Supported barcodes:
 - 1D – Barode,
 - 2D – Data Matrix Code
- Every workpiece is exactly identified for the further workpiece flow

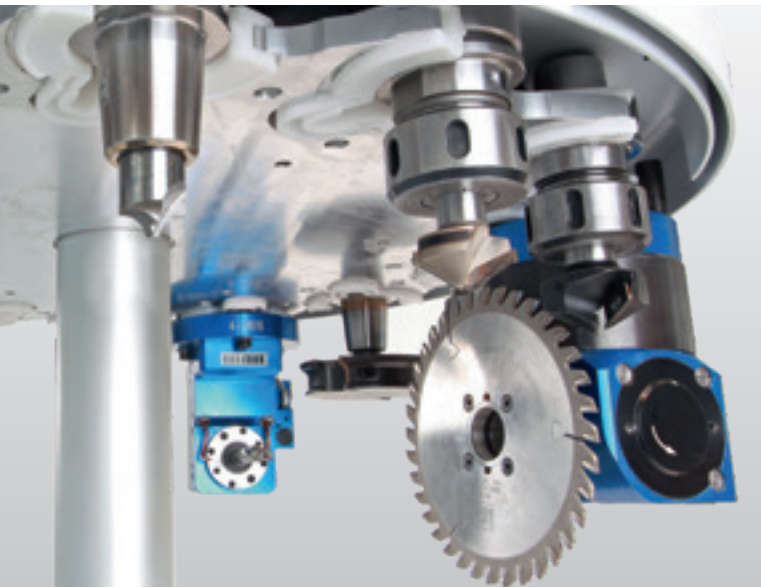

Processing unit technology

INNOVATION. PRECISION. PASSION. Over 20 years of experience in the development of units are reflected in the advanced stage of today's unit engineering. The HOMAG units are distinguished by their extreme rigidity, outstanding precision and stability.



C-axis (0-360°) for the use of units



Extension to FLEX5 consisting of FLEX5 interface and FLEX5 unit



Sawing
350-series saw blade

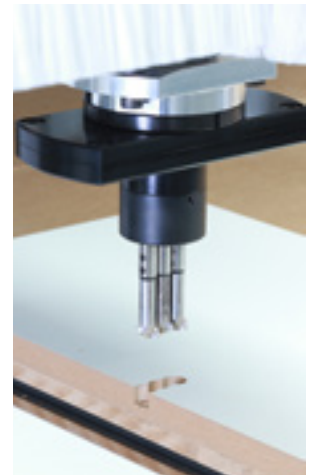

Setting fixtures
Cabineo unit

High Performance units ensure optimum lubrication of gear components for prolonged operations.



HIGH PERFORMANCE
Drilling/Sawing/Routing

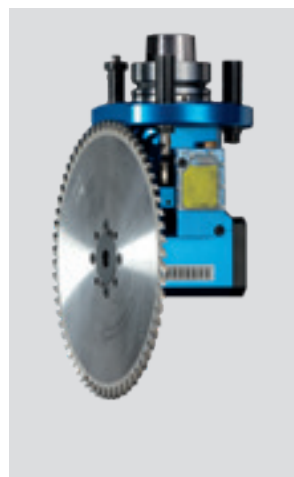

HIGH PERFORMANCE
Sawing Ø 220 mm



HIGH PERFORMANCE
Planing unit | Tool diameter max. 120 mm



Drilling/Routing/Sawing
2 spindles
(also available as HIGH PERFORMANCE unit)



Drilling/Sawing
swivelling (0° - 90°), Ø 180 mm
(also available as HIGH PERFORMANCE unit)



Routing
with 4-fold blowing nozzle

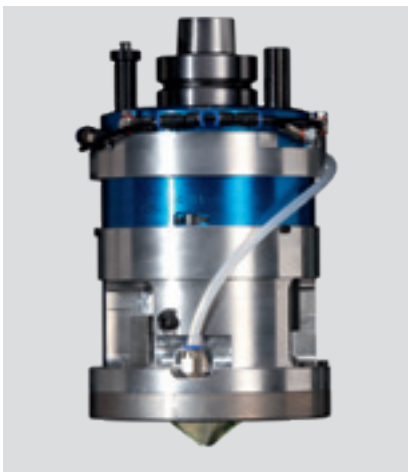

Tracing routing unit with tracing ring
Ø 70 mm | Ø 130 mm



Cutting unit
1 cutting blade | 10 mm cutting surface



Foil cutting unit
1 cutting wheel | Ø 75 mm



Drilling/Routing
swivelling cranked (0° - 90°),

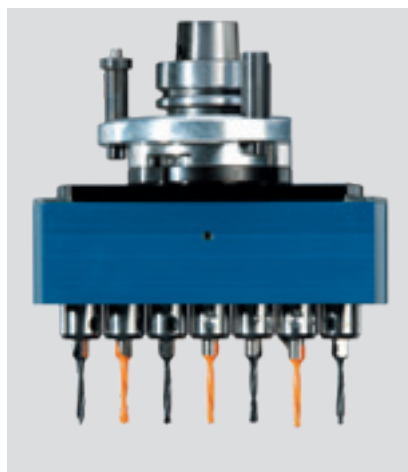

Drilling
7 spindles, 25 mm raster



Fitting drilling head
3 spindles

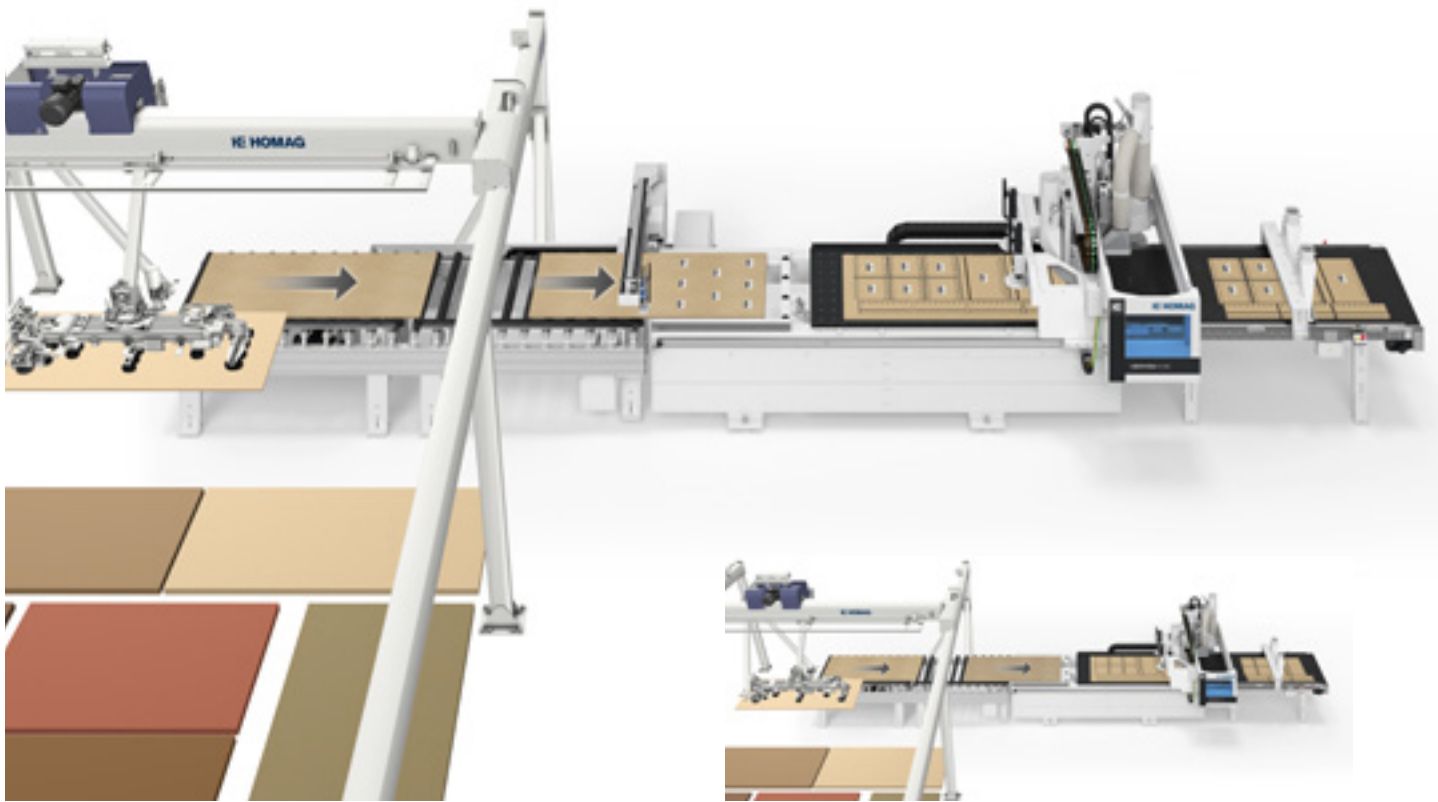

Nesting concept 3R with storage

Nesting concept 2R with storage

We have the solution for your nesting requirements!

With the HOMAG nesting solutions you are always well-advised. Whether the workpieces should be fed by hand, by lifting carriage or by storage – we have always the proper concept for your application. You wish to identify, for example, the workpiece flow exactly by barcode? No problem! With our plug & play features, we enable the successive expansion of the machine from concept 1 onwards.



Label printing system

- Automatic labelling of raw boards before processing
- Modular concept – plug & play (retrofitable)
- Fast – 60 m/s in X-direction

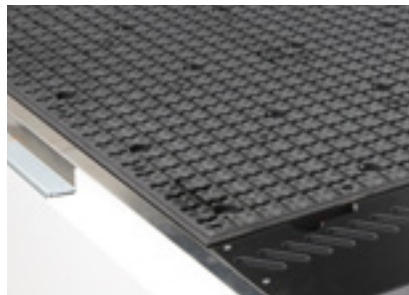

Air cushion function

- Optimal and smooth feeding of workpieces for easy handling

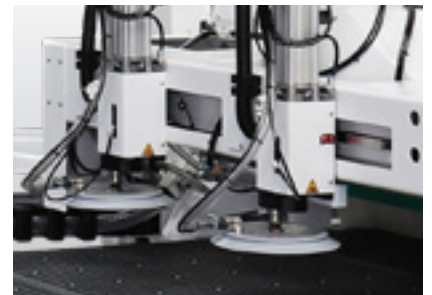

Infeed- and push-off function

- For simultaneous infeed of the raw material and push-off of processed workpieces



Basic machine with outfeed conveyor



Nesting concept 1



Nesting concept 2



Nesting concept 3



Nesting concept 2R



Nesting concept 3R

Handling solutions for CENTATEQ N-600

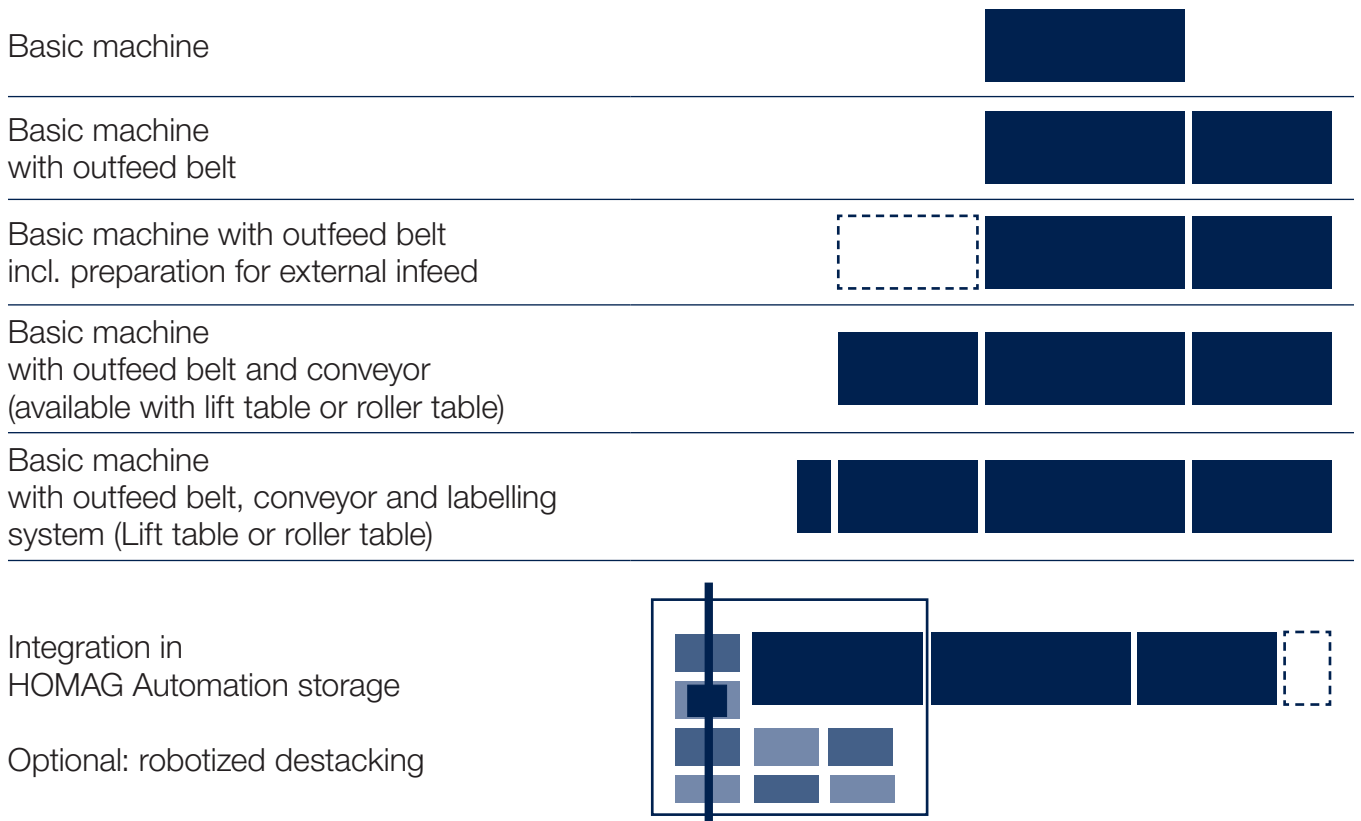

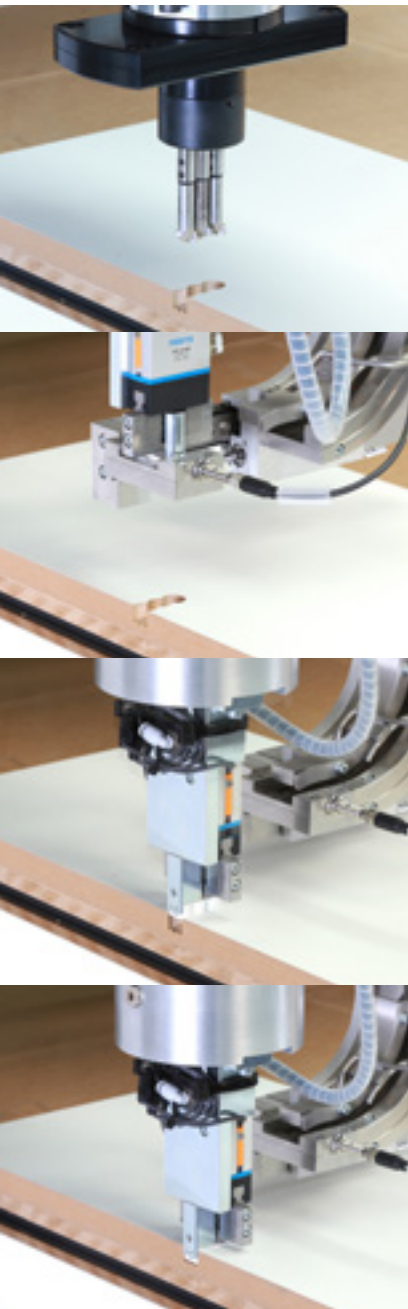

A world first: fitting insertion technology meets processing center

Flush connectors, fixtures or hinges can be fed onto the CNC machine. The connectors are sorted and loaded onto trays using a vibration conveyor. Up to 32 connectors are transported directly to the unit and can be pushed into the workpiece in a single process step.

Robot Connection

The smart concept allows parts to be picked from the entire nest as required and placed on a roller conveyor or stacked smartly onto a pallet. The workpieces can also be sorted into a transport carriage depending on the order.



Picking from the nest

- The robot has access to the entire nest
- The data for the workpieces is transmitted from the optimization plan to the robot



Efficient robot cross rail

- Individual and automatic control of the individual suction nipples. Gentle workpiece handling thanks to rubberized suction unit surfaces
- Structures in the workpiece can be offset without reducing the suction power



Identification of the workpiece zero point

- After picking, the precise workpiece zero point is identified using a smart laser system, enabling precise stacking on a pallet

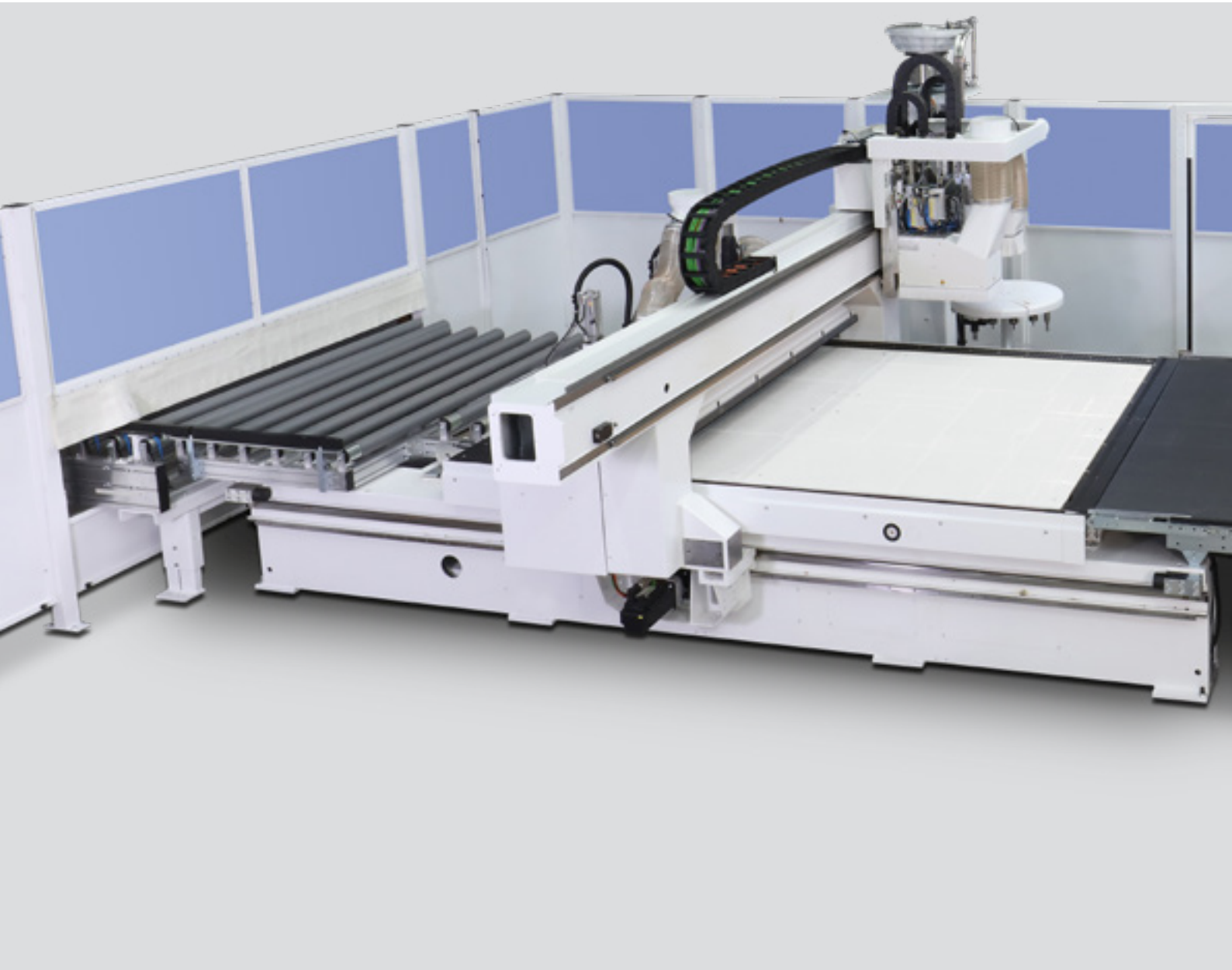

CENTATEQ N-600 with robot connection

Production time, material yield, parts handling and logistics: efficient CNC processing including cutting requires expertise. HOMAG's business units provide the right solution for you, from the individual machine right down to the fully automated nesting cell including robotized destacking.

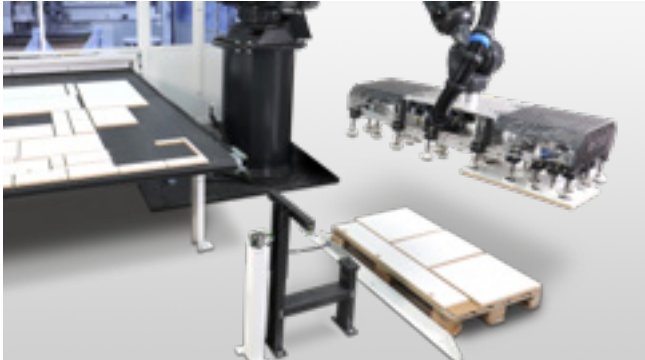
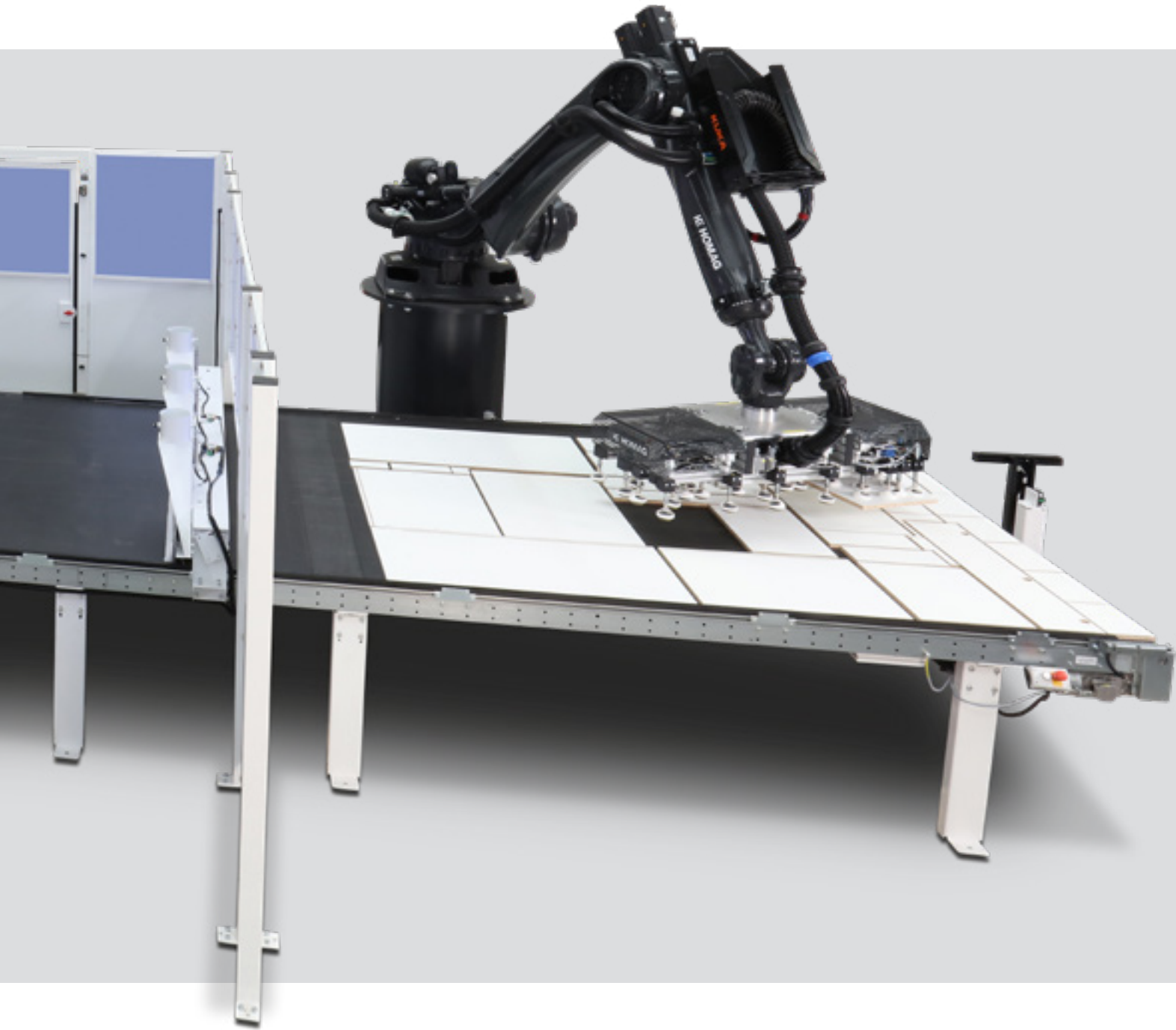

CENTATEQ N-600 | Everything at a glance...

With these packages you are up to all tasks. The choice is yours.

	Table sizes	Tool changing spindle				Unit interfaces							Drilling gear				Tool changer disk type with pick-up fixed (optional)	
	 7 x 10 ft	10 kW air-cooled	13,2 kW air-cooled	11 kW liquid-cooled	16 kW liquid-cooled	360° adjusting axis	C-axis	C-axis for Flex5 unit	DRIVE5CS 10 kW	DRIVE5CS 12 kW	Interface	Vibration sensor	V12	V12 + H6 + grooving saw	V21	V21 + H8 + grooving saw	14-fold	28-fold
Basic machine	●	○	○	○	○	○	○	○	○	○	○	○	○	○	○	○	○	○
Nesting concept outfeed	●	○	○	○	○	○	○	○	○	○	○	○	○	○	○	○	○	○
Nesting concept 1	●	○	○	○	○	○	○	○	○	○	○	○	○	○	○	○	○	○
Nesting concept 2	●	○	○	○	○	○	○	○	○	○	○	○	○	○	○	○	○	○
Nesting concept 2R	●	○	○	○	○	○	○	○	○	○	○	○	○	○	○	○	○	○
Nesting concept 3	●	○	○	○	○	○	○	○	○	○	○	○	○	○	○	○	○	○
Nesting concept 3R	●	○	○	○	○	○	○	○	○	○	○	○	○	○	○	○	○	○
Nesting concept 4	●	○	○	○	○	○	○	○	○	○	○	○	○	○	○	○	○	○



Automation level						Equipment													
						tapio-ready	PowerControl with powerTouch	Synchronous drive	Vacuum arms for panel positioning	Push-Off device for workpieces	Extraction in the outfeed from below	Extraction in the outfeed from above	Vacuum system	Clamping elements	Air cushion function	Air-conditioning	Simultaneous pull-in and push-out		
-	-	-	-	○	-	✓	✓	✓	-	-	-	-	✓	○	○	○	-		
✓	-	-	-	○	-	✓	✓	✓	-	✓	○	○	✓	○	○	○	-		
✓	✓	-	-	○	-	✓	✓	✓	✓	✓	✓	○	✓	○	○	○	○		
✓	✓	✓	-	○	-	✓	✓	✓	✓	✓	✓	○	✓	○	○	○	○		
✓	✓	-	✓	○	-	✓	✓	✓	✓	✓	✓	○	✓	○	○	○	○		
✓	✓	✓	-	○	✓	✓	✓	✓	✓	✓	✓	○	✓	○	○	○	○		
✓	✓	-	✓	○	✓	✓	✓	✓	✓	✓	✓	○	✓	○	○	○	○		
✓	✓	-	✓	○	✓	✓	✓	✓	✓	✓	✓	○	✓	○	○	○	○		

Standard: ✓ Available: ● Option: ○

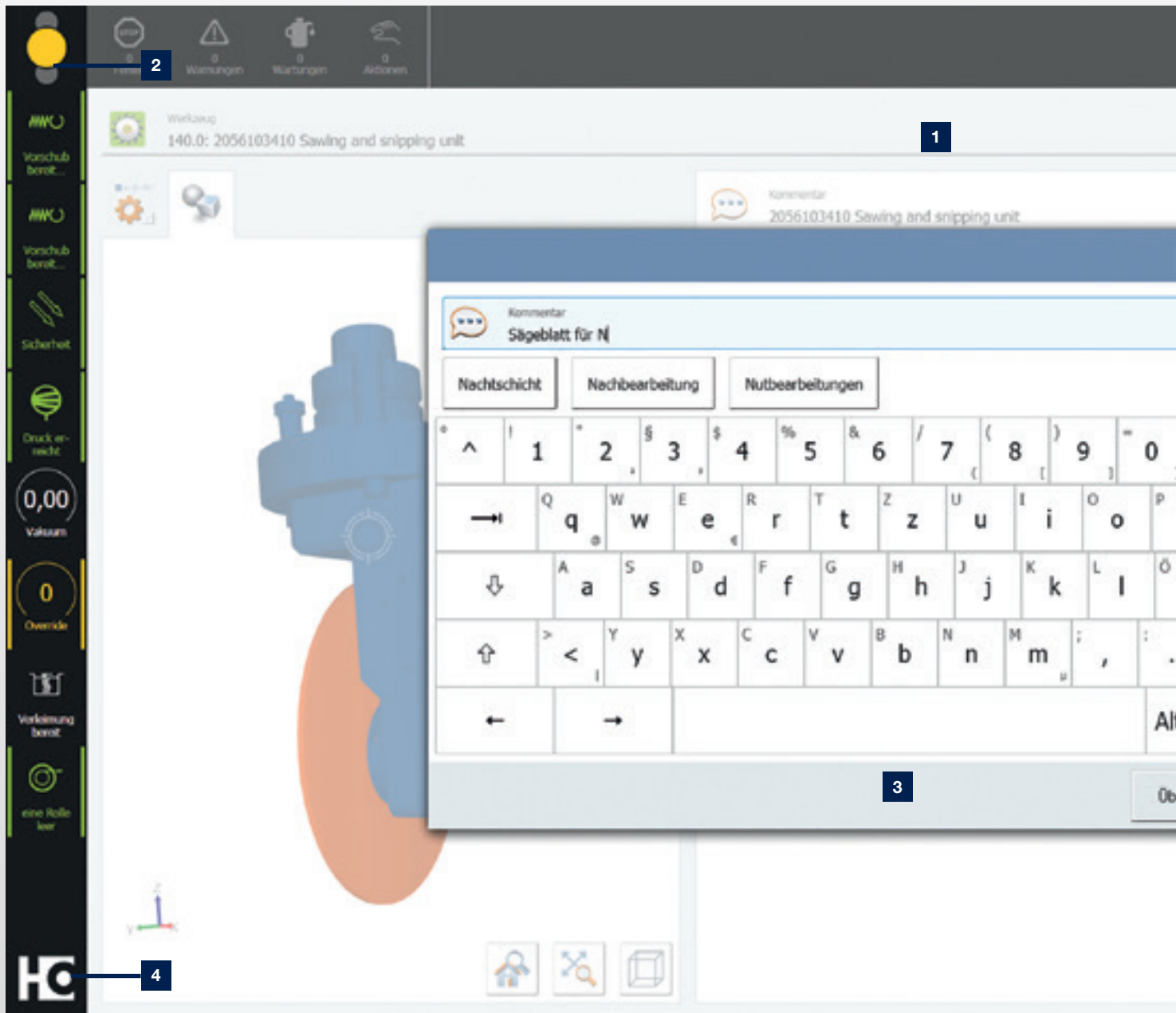

- 1 The powerTouch2 screen is clearly laid out and logically structured. You can see all the main information at a glance, but you still have all the details.
- 2 We have also improved the traffic light dialog again. You can now directly influence the machine's production readiness by selecting actions via the traffic light icon.
- 3 A functional pop-up keyboard that can be kept open, including automatic word completion for faster entries (when you enter the first letters, frequently used applications are proposed and you can select them directly).
- 4 Enhanced "Start" menu with additional information displayed (e.g. an indication of how many messages are currently pending or status bars that show the progress of the application) and direct access to actions (e.g. confirmation of actions without having to jump to the application).

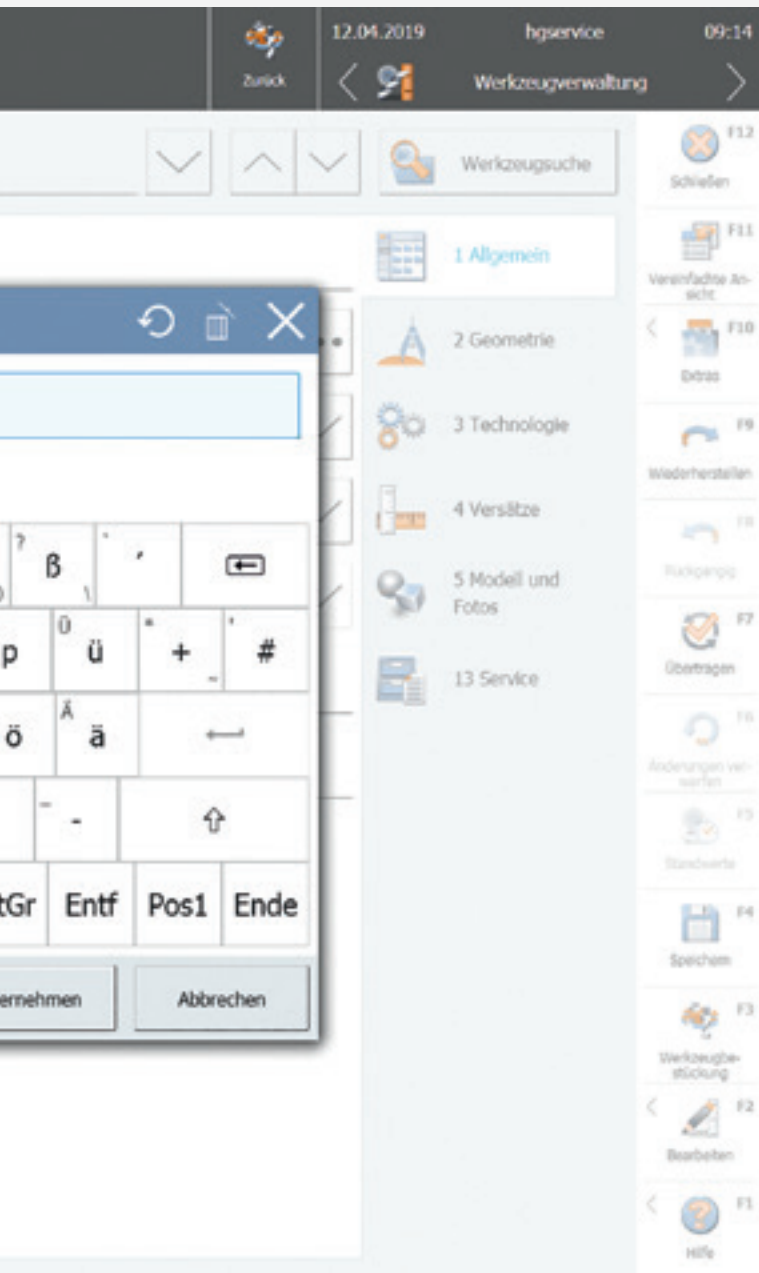

The next generation of powerTouch: **powerTouch2**

Faster, clearer, easier to use: reap the benefits of our powerTouch touch user interface, which has been developed further. We have optimized our standardized operating concept further and adapted it to the needs of our customers. You can now control your HOMAG machines more quickly and more intuitively. The new and contemporary design is clearly structured. The innovative touch operation is designed to enable you to get the desired result easily and comfortably.

With the new powerTouch generation, you can enter valves on the machine more quickly. This saves you up to 30% of time compared to the previous version. This is all possible thanks to new features, such as automatic word completion, a pop-up keyboard that can be kept open, and Windows-like functions such as the ability to select frequently used actions directly via the start button.

Our successful powerTouch philosophy – **standardized, simple, ergonomic, evolutionary** – consistently further developed



THE HIGHLIGHTS AT A GLANCE:

- Direct and efficient operation, up to 30% faster
- More informative and more transparent thanks to additional information and live preview images instead of program icons
- New applications for operating and controlling machines and plants (e.g. NCCenter in a PC87 control system for CNC machines, or woodCommander 4 for throughfeed machines).
- Fresh, attractive design based on the new HOMAG machine design

intelliDivide Nesting – cutting optimization for CNC machines

intelliDivide is the web-based cutting optimization program of the HOMAG Group. Depending on the machine type chosen, the software automatically switches to panel cutting using a saw or to the nesting with a CNC machine.

The cloud-based optimization software enables significantly higher computing capacity, ensuring that results are available quickly — and with considerably better key figures.



The benefits:

- No local hardware is needed. IntelliDivide operates independently of the operating system; internet access is all that is required
- Users do not have to worry about maintenance or updates
- Low-cost entry into optimization
- Intuitive, simple operation.
- Simple, usage-based booking possible. Whether a free trial month, monthly purchase or annual subscription, every customer chooses the best option for them.

Design furniture online and automatically receive all production data – with the cabinetCreator

There are now many online stores in the industry. However, these stores tend to be operated by suppliers, from whom end customers order their furniture. With the cabinetCreator, HOMAG is offering the industry's first web-based furniture design wizard, which allows the customer to create cabinets for its end customers. The integrated scan connector adds all fixtures automatically. All relevant data is then generated so that the cabinet can be manufactured.

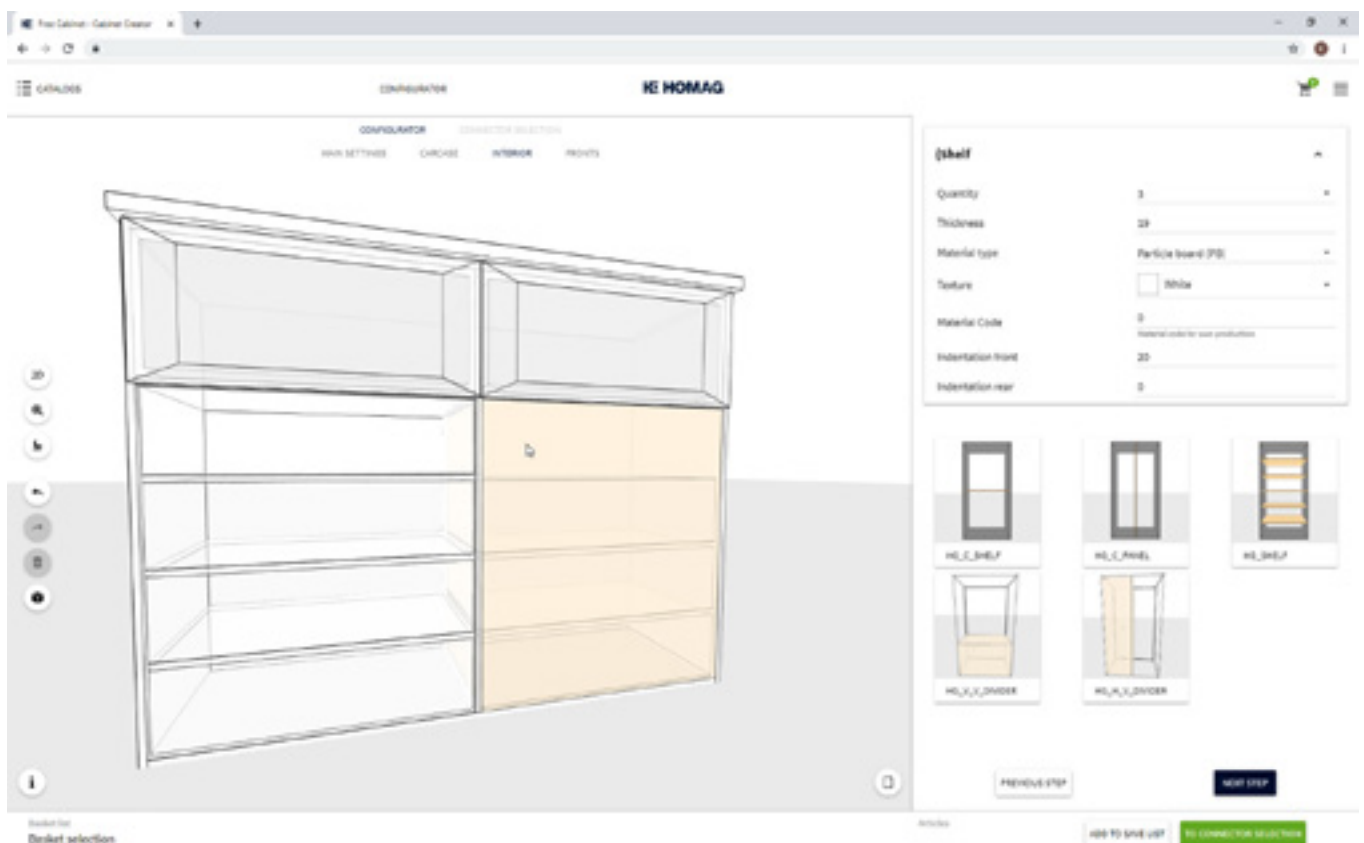

Customer benefits:

- Easy operation with step-by-step navigation
- Very fast generation of production data
- Option of setting up a custom furniture library
- Storage of individual design rules

The benefits:

- Web-based configuration of furniture bodies, so no local hardware is required
- cabinetCreator operates independently of the operating system – Internet access is all that is required
- Users do not have to worry about maintenance or updates
- Library of basic forms, e.g. straight cabinets, corner cabinets, cabinets for sloping ceilings
- Fixture selection available from all established manufacturers: Blum, Grass, Häfele, Hettich, Lamello
- 2D/3D image of the furniture
- All relevant production data generated: customer order, parts list for cutting, CNC programs, single part drawings, 3D assembly drawing

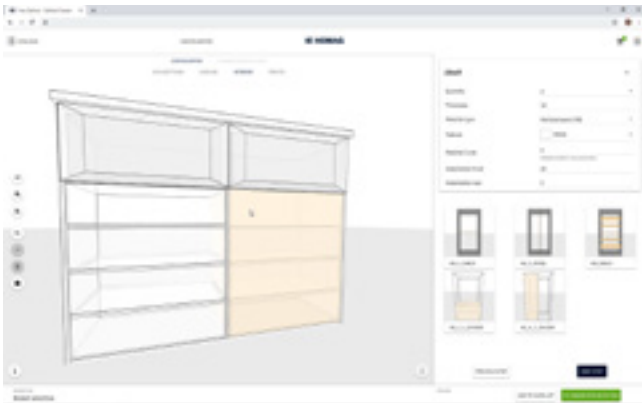

cabinetCreator

- Design furniture online and automatically receive all production data

Software | Machine

Our machines are equipped with everything needed for productive use as standard. In addition, a wide range of software modules can be supplemented to create the optimum configuration.

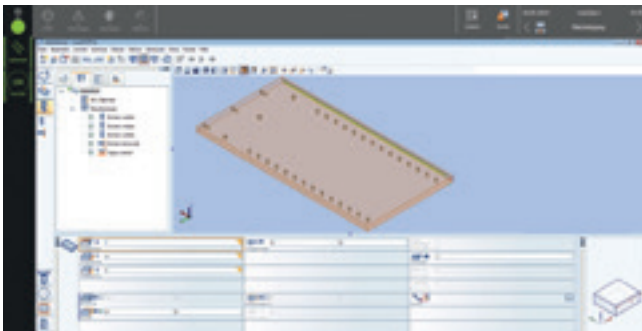

woodWOP

- Modern software based on Windows®
- Import of CAD files in DXF format
- More than 30.000 installations worldwide
- Worldwide largest forum for woodWOP



Production list software

- For management and creation of product lists for individual manufacturing



Slot assignment

- Simple control of main machine functions through soft keys
- Graphical loading



MMR Basic

- Machine Data Recording – collecting and evaluating machine states via time meter and event meter
- Display and logging of maintenance measures

Process optimization

Cut Rite, the optimization software of the HOMAG, is used for cutting boards on sawing machines as well as nesting machines. The modular structure of the software allows users already controlling their sawing machine via Cut Rite to integrate the nesting module without problems. Plus, customer processes can be made even more efficient by woodCAD|CAM and residual parts management.

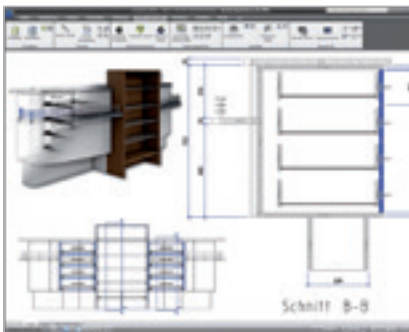

woodCAD|CAM

- Parametric design in 3D
- Seamless data flow in operation
- Bill of materials, cutting to size and cost estimation
- CNC data for HOMAG Group machines
- Bar code generation
- Photorealism for sales negotiations

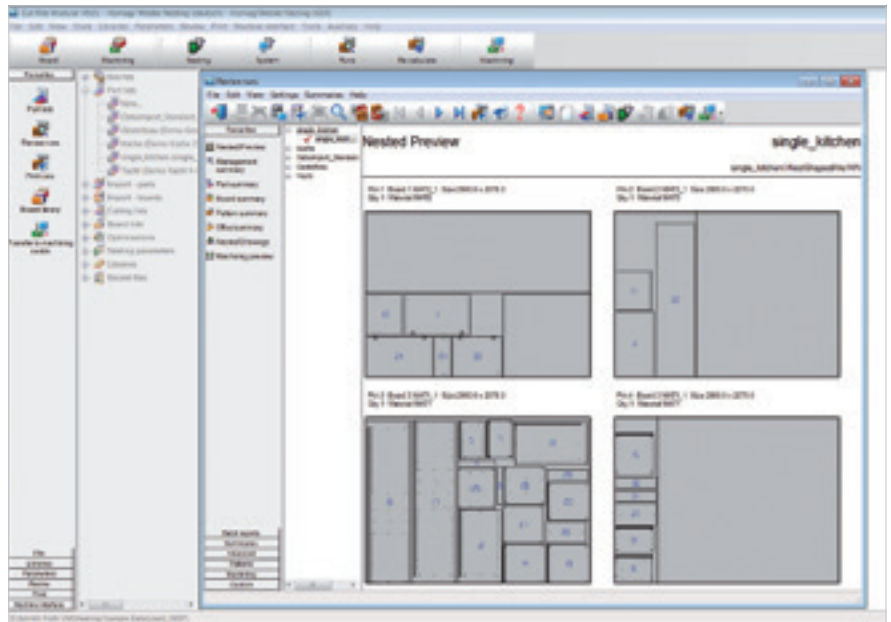

Optimization software: woodNest Basic and Cut Rite Nesting

- Optimization and generation of cutting plans for rectangular and free-formed workpieces (woodNest Basic: manually | Cut Rite: automatically)
- Functions with Cut Rite:
 - Import of parts lists, e.g. from Excel, or direct import of woodWOP programs
 - Additional milling strategies “bars”, “common line” and “stay down”
 - Includes material management, parts sorting by material type, and label printing in the office
 - Manual editing of cutting plans



Residual parts management | Basic

- Labels for residual parts from Cut Rite
- Manual management



Residual parts management | Advanced

- Automatic management within the storage database
- Manual positioning in automatic mode
- Labels for residual parts can be produced on the machine itself

Residual parts management | Professional

- Automatic residual parts handling for nesting concepts in conjunction with storage solutions from HOMAG Automation
- Only in combination with residual parts management | Advanced

Easy to get. And easy to use.

tapio is the open wood industry ecosystem

This means that everyone involved in the wood industry can participate.
Because together with our business partners, we develop digital solutions for everyone.



Just have a try:

MachineBoard is available immediately free of charge for HOMAG machines! To use MachineBoard, all you need to do is register with tapio and ensure the machines are connected — which you can do easily at www.tapio.one.

Apps that make working life easier

tapio

Partner

DataSave

- Protects machine and configuration expertise
- Faster service in case of breakdown
- Saves time when restarting production
- Saves on maintenance costs
- Automatic backups of several machines

ServiceBoard

- Create service cases quickly and easily and send them to the correct service partner
- Live video diagnostics to solve service cases with image support
- Video reduces the language and distance barriers
- Also works without a machine connection to tapio (and is therefore ideal for older machines)

MachineBoard

- Push notifications
- Machine data and status can be viewed from anywhere in real time
- Lists of errors, warnings, maintenance tasks and actions
- Displays the remaining time until the next intervention by the machine operator



Free demo for all tapio apps, no registration required. Simply download and test.

Currently available in the EU and Switzerland.

(Due to the fast pace of the IT-landscape, the compatibility to the tapio platform is warranted for five years.)

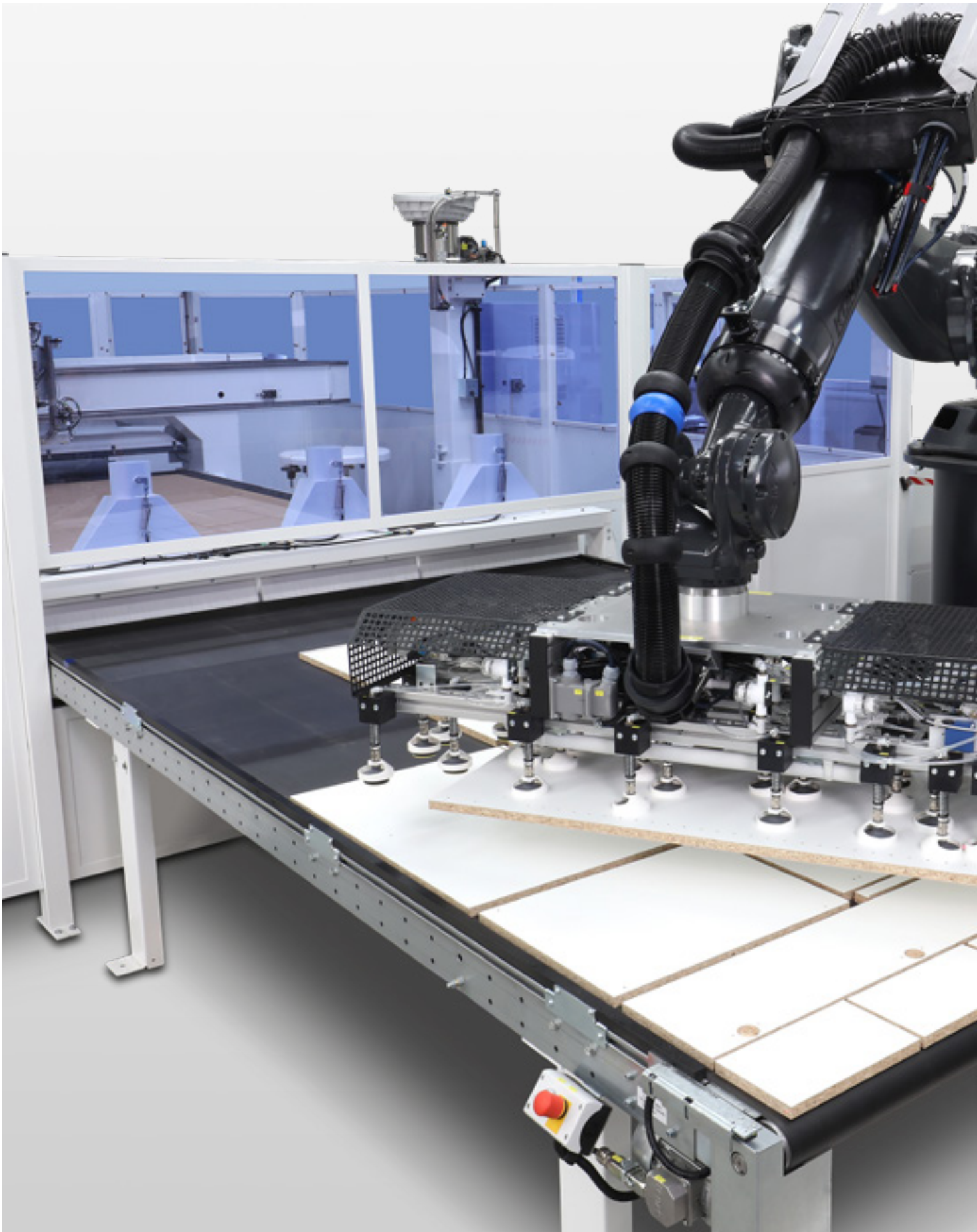



Do you need automation?
CENTATEQ N-600 with hardware
insertion and robot interface!

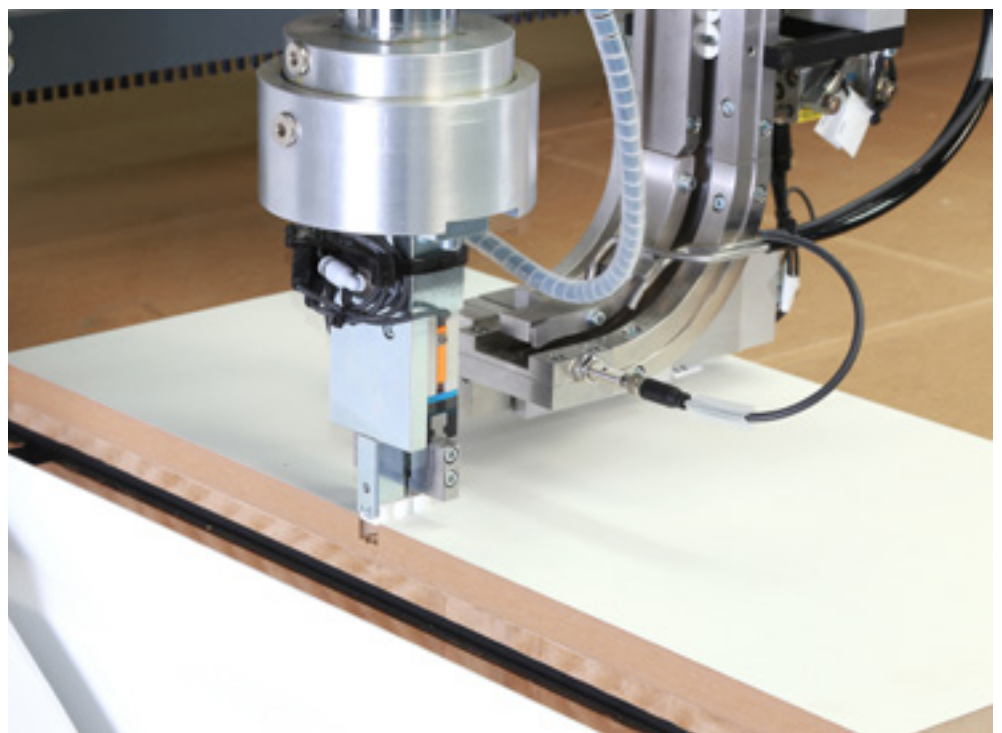

Technical data



CENTATEQ N-600	
Working field in X	3,100 / 122.0
Working field in Y	2,250 / 88.6
Working field in Z - without automation	210 / 8.3
Working field in Z - with push-off device	125 / 4.9
Working field in Z - automatic push-off	60 / 2.4
	mm / inch

Vector speed X/Y - Z-axis	m/min	130 - 20	
Compressed air connection	inch	R ½	
Compressed air	bar	7	
Dust extraction port	mm	Ø 200*	
Dust extraction volume	m³/h	min. 3,170*	
Electrical connection value	kW	27,5*	
			*Basic machine

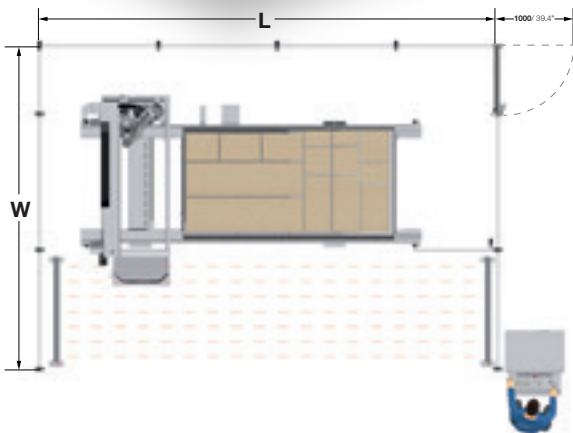
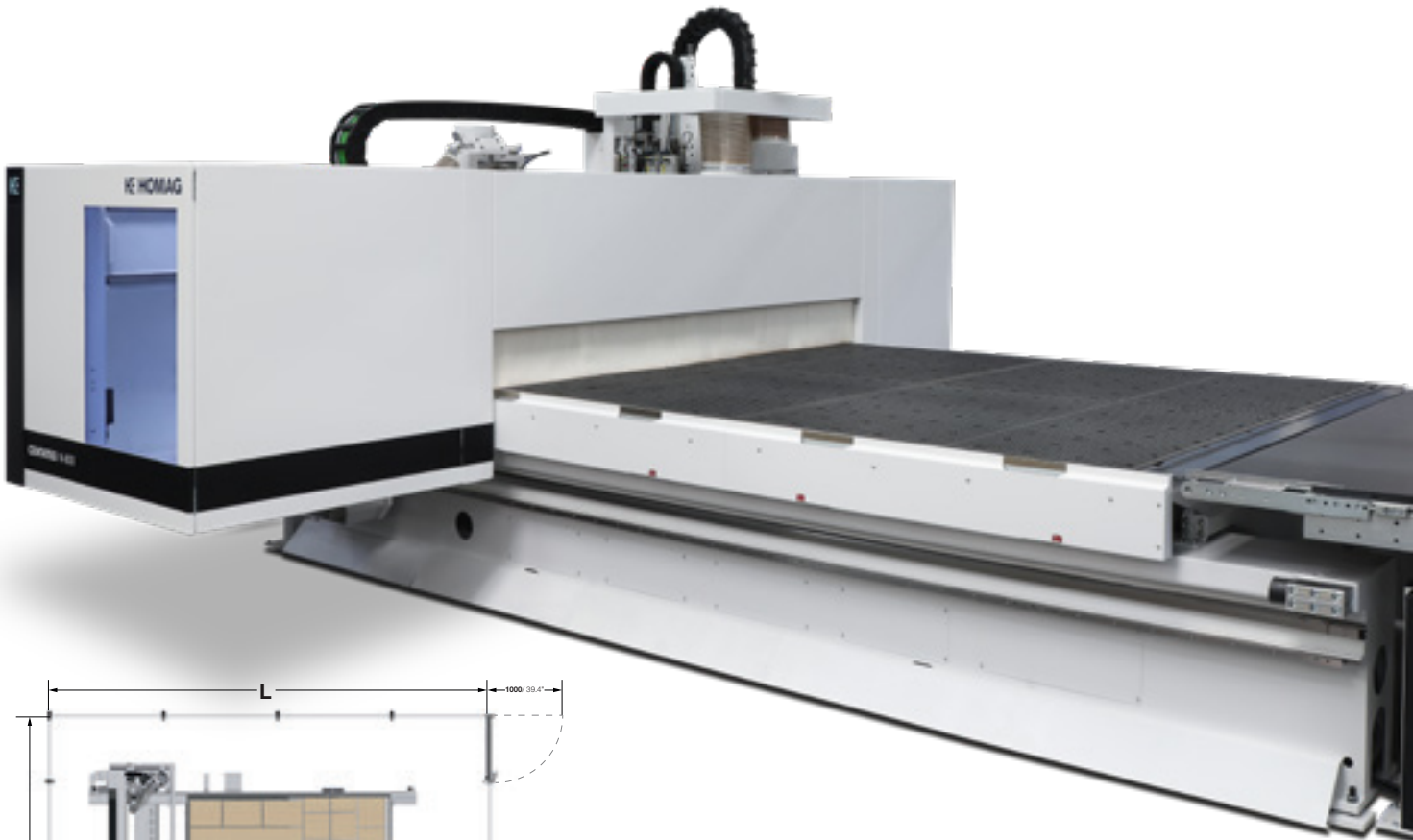

Floor space incl. safety area		L	W
Manual concepts			
Basic machine	7 × 10 ft	7.030 / 276.7	6.150 / 242.1
Nesting concept Outfeed	7 × 10 ft	9.400 / 370.1	6.150 / 242.1
Automatic concepts			
Nesting concept 1	7 × 10 ft	9.750 / 383.9	6.150 / 242.1
Nesting concept 1R	7 × 10 ft	13.380 / 526.8	6.150 / 242.1
Nesting concept 2	7 × 10 ft	12.720 / 500.8	6.150 / 242.1
Nesting concept 3	7 × 10 ft	13.470 / 530.3	6.150 / 242.1
Nesting concept 3R	7 × 10 ft	14.670 / 577.6	6.150 / 242.1
			mm / inch

HC LIFE CYCLE SERVICES

Optimal service and individual consultations are included in the purchase of our machines. We support you with service innovations and products which are especially tailored to your requirements. With short response times and fast

customer solutions we guarantee consistently high availability and economical production – over the entire life cycle of your machine.



REMOTE SERVICE

- Hotline support via remote diagnosis by our trained experts regarding control, mechanics and process technology. Thus, more than 90% less on-site service required and consequently a faster solution for you!
- The ServiceBoard App helps to solve tasks in a fast, simple and concrete way. This is achieved by mobile live video diagnosis, automatic sending of service requests or the online spare parts catalog eParts.



SPARE PARTS SERVICE

- High part availability and fast delivery.
- Ensuring quality by predefined spare parts and wear parts kits, comprising original spare parts.
- Identify and inquire for spare parts online under www.eParts.de 24/7, or buy even faster and more comfortably in the new HOMAG Webshop eCommerce.



MODERNIZATION

- Keep your machinery up to date and increase your productivity as well as your product quality, This is how you can meet tomorrow's requirements today!
- We support you with upgrades, modernization as well as individual consultancy and developments.



DIGITAL SERVICES

- ISN (intelliServiceNet) – The new remote service solution of the future! Fast restart of production because the remote service employee has extensive access to relevant physical data.
- intelliAdvice App – provides help for self-help. The preventive solutions proposed in the new App are the combination of our experiences and existing machine data.



SOFTWARE

- Telephone support and consultancy through software support.
- Digitalization of your spare parts via 3D scanning saves time and money compared to new programming.
- Subsequent networking of your machinery with intelligent software solutions ranging from construction to production.



FIELD SERVICE

- Increased machine availability and product quality by certified service staff.
- Regular checks through maintenance / inspection guarantee the highest quality of your products.
- We offer you the highest availability of technicians in order to reduce downtimes in case of unpredictable troubles.



For you more than...

1,350
service employees worldwide

90 %
less on-site service thanks to
successful remote diagnosis

5,000
customer training sessions per / year

150,000
machines, all electronically documented
in 28 different languages – in eParts



TRAINING

- Thanks to training perfectly suited to your requirements, your machine operators can optimally operate and maintain the HOMAG machines.
- The training also include customer-specific training documents with exercises proven in practice.
- Online training and webinars. Learn without traveling, meet your trainer in the digital classroom.

HOMAG Group AG

info@homag.com

www.homag.com



YOUR SOLUTION