

# A complete System. Maximum Performance .

**HE HOMAG**

## **Processing centres**

CENTATEQ P-500|600

CENTATEQ E-500

**YOUR SOLUTION**







## Be on the safe side with HOMAG

An investment in a new machine or plant should not be an experiment. Opt for a competent, experienced and reliable partner you can trust – opt for HOMAG.

### YOUR SOLUTION

### CONTENT

- 06 Economy from the factory floor
- 10 As individual as your requirements
- 12 Versatility - productively manufactured
- 14 Scalable performance
- 16 Trimming spindles
- 18 Drilling systems to the highest standard
- 20 Tool changer
- 21 Units
- 22 Edge banding
- 24 Innovative edge banding technology for all
- 26 Table variants
- 30 Special clamping devices
- 32 Automation
- 34 Software/control
- 36 Life Cycle Services
- 36 Technical data



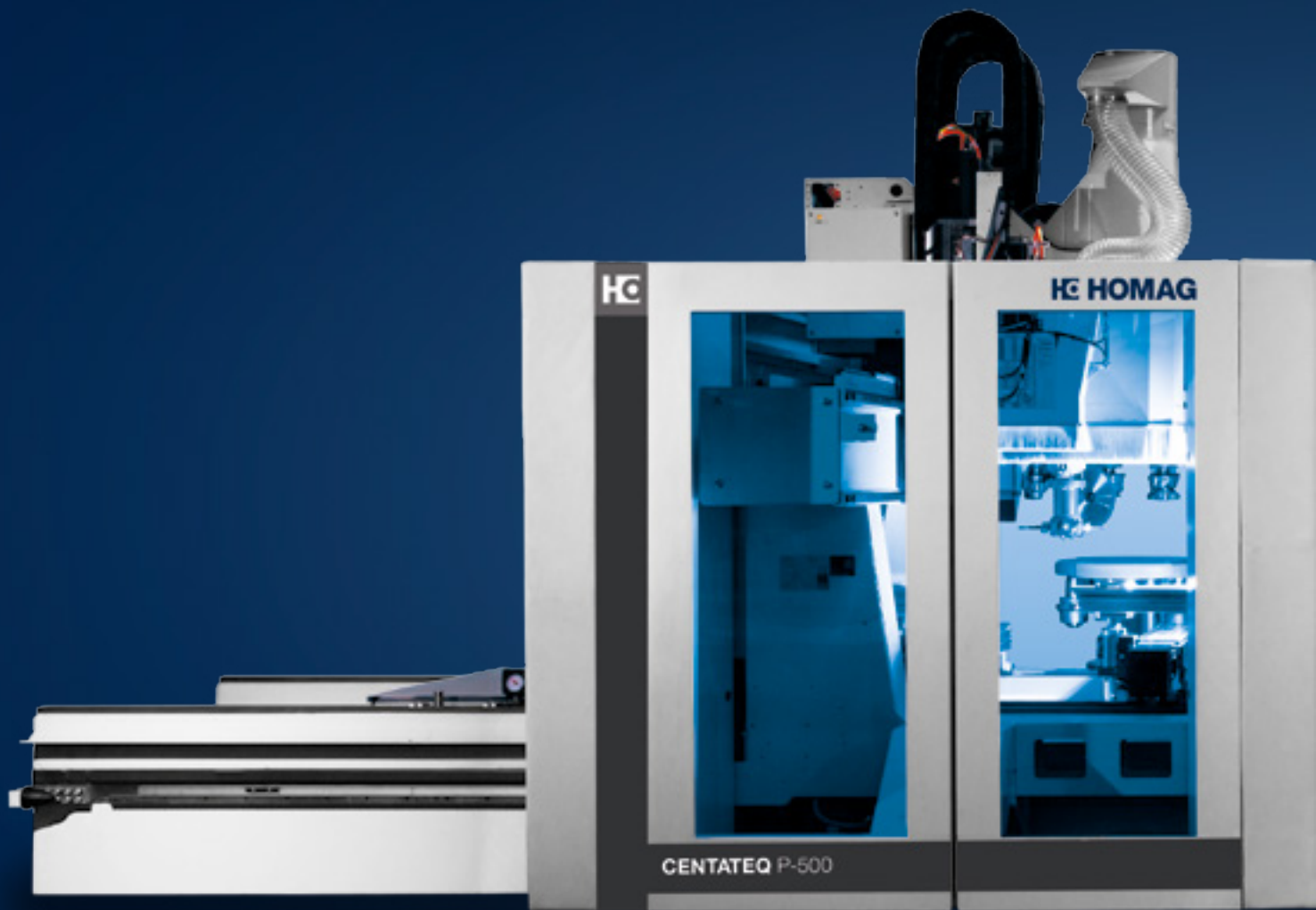

HC

HC HOMAG

CENTATEQ P-500

# CENTATEQ P-500

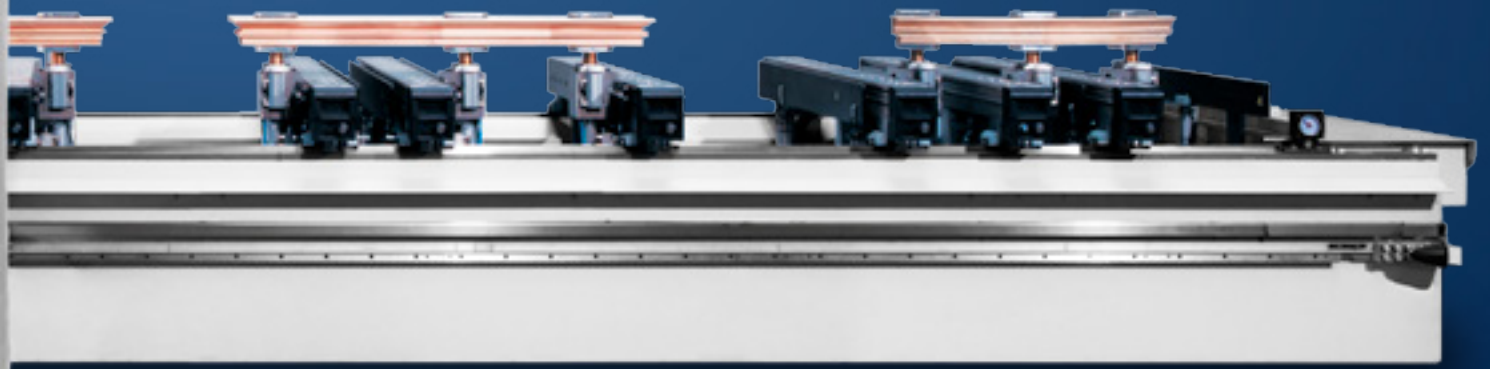



**CENTATEQ P-500:** 4- and 5 axis combination with automatic table for the production of doors and staircases

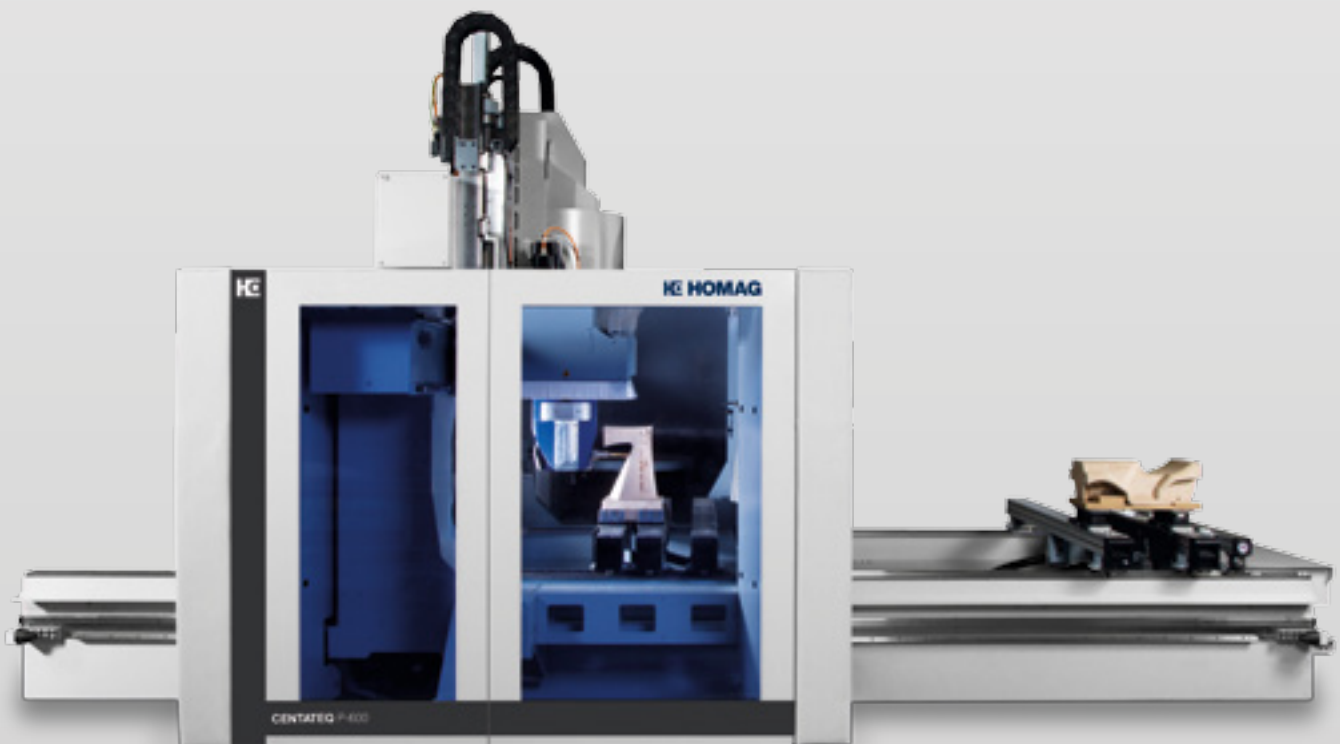

**CENTATEQ P-600:** High Z-axis and DRIVE5+ 5 axis-head with double side bearing for 3D parts processing up to 500 mm



**CENTATEQ E-500:** Processing center for edge banding of shaped parts with 2 independent Y-axes

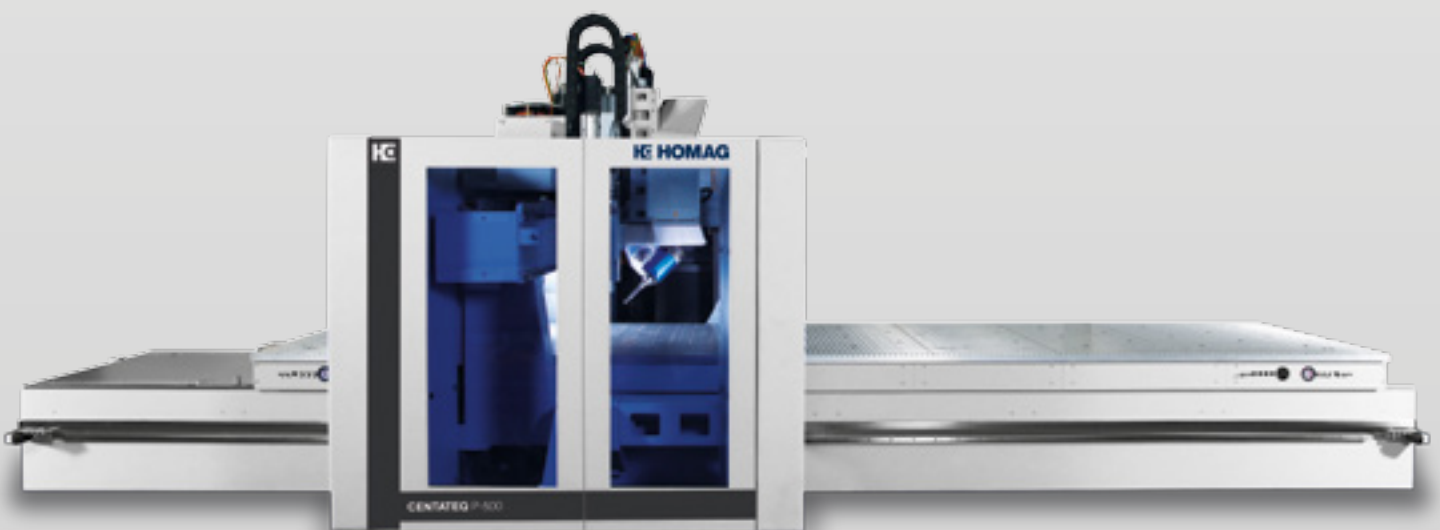

**CENTATEQ P-500:** Processing center with aluminium matrix table for processing of technical components, shaped parts and Nesting

## Economy from the factory floor

Deciding in favour of a HOMAG machine means investing in a highly efficient processing centre with the capability to fulfil wide-ranging different manufacturing requirements.

Each machine is a complete system guaranteeing maximum output and efficiency every time – no matter how individual your production requirements are.

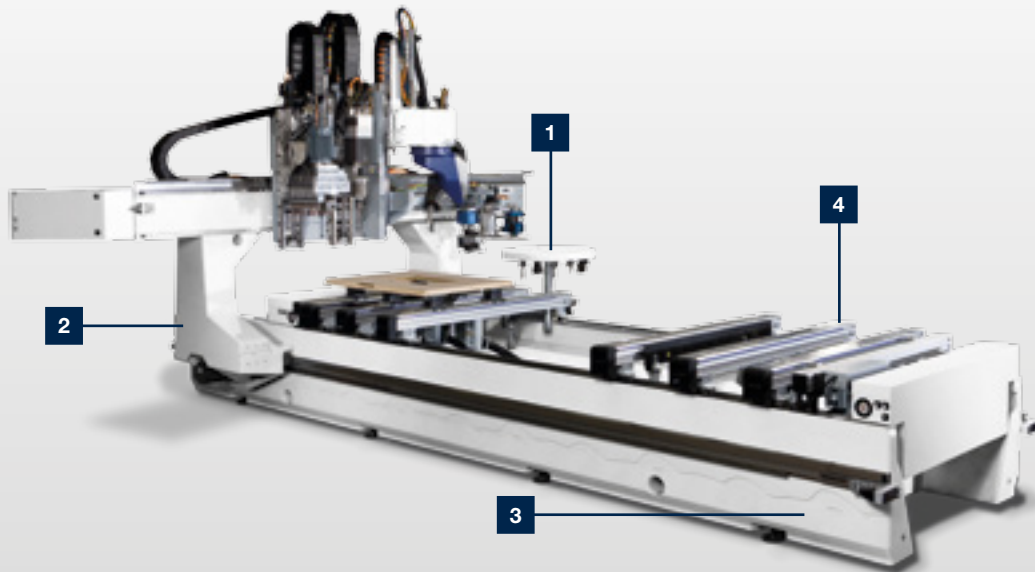

**1 Scalable output through individual equipment of the moving gantry with trimming spindles, drilling heads and tool changers.**

**2 Moving gantry with bilateral drive for processing depths up to over 3,000 mm**

**3 The perfect machine table for every job. Designed for a save and precise workpiece fixture.**

**4 Machine frame made of SORB TECH mineral composite material**



**Protecting the environment and improving economy:** A heavy-duty machine bed made of the new vibration-absorbing material SORB TECH helps save around 60 % primary energy and enhances processing quality.



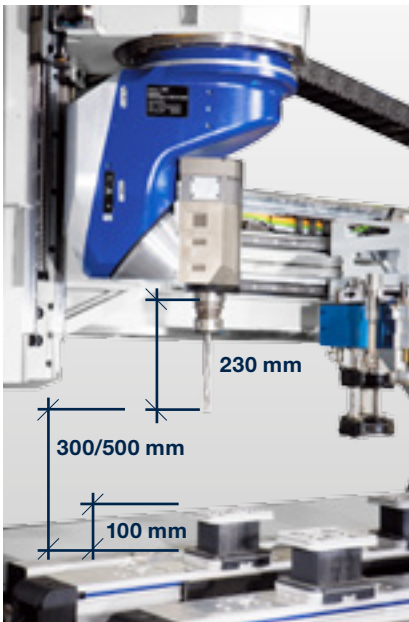

**Block processing:** Cubic workpieces of up to 300 mm (500 mm) in height can be processed by the large 600 mm (910 mm) axes, even when working with the maximum workpiece length of 230 mm (measured from the HSK support).



**Switch cabinet with powerTouch**

**operator terminal:** Central switch cabinet with height-adjustable Full-HD Multitouch Display, USV for protection against data loss, Backup-Manager for data backup and network connection. Light at the switch cabinet for status display.

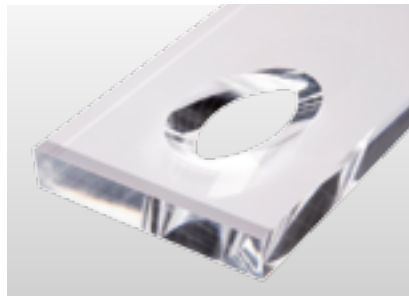

**Outstanding surface quality** due to vibration-damping machine beds and gantry.



**Energy efficiency built in:** Effective suction with low connecting power through optimized collection and removal of chips. Reduced consumption of electricity through Stand-by operation of all performance components by pushing a button or automatically by time interval. Reduced air consumption through optimized pneumatic components.

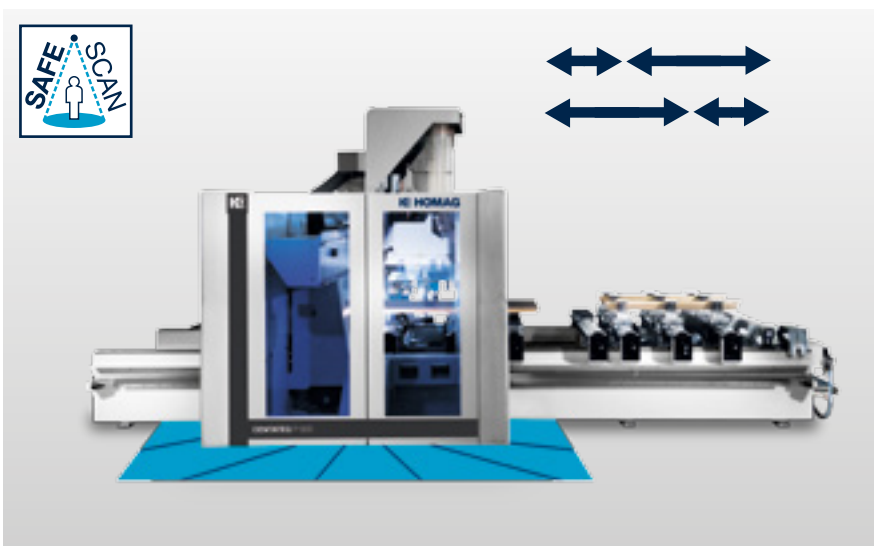

**Dynamic alternating field size:** The safety system allows a dynamic alternating field size without fixed field allocation. This means that when processing longer parts on one side of the machine, it is still possible to prepare and position a shorter part on the other side. **safeScan safety system:** Two-step safety system (patented) with feed reduction in the warning area and stop on bumper contact. The no-contact monitoring system combines optimum working safety, simple access to the machine and high performance.

# As individual as your requirements

Deciding in favour of a HOMAG machine means investing in a highly efficient processing centre with the capability to fulfil wide-ranging different manufacturing requirements. Each machine is a complete system guaranteeing maximum output and efficiency every time – no matter how individual your production requirements are.

## SHAPED WORKPIECES

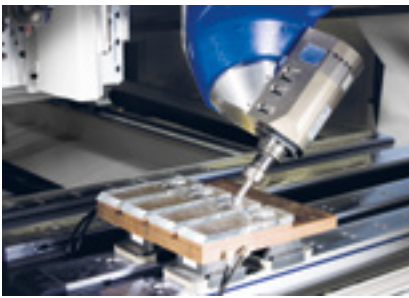

High-gloss trimming of acrylic parts

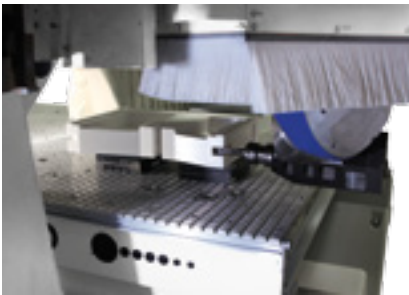

Trimming of machine components

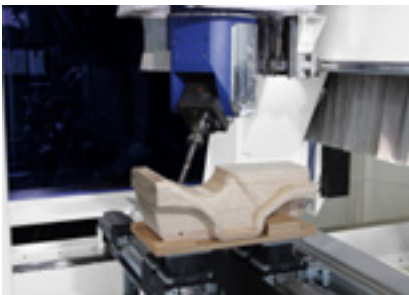

Interpolating processing of freeform components



Trimming of components with large Z height



## STAIRCASES

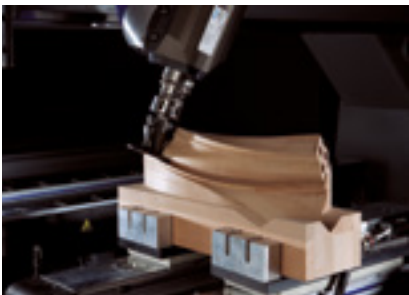

Routing of a stair hand rail

## DOORS



Precise, splinter-free miter cuts

## FURNITURE



Chamfer trimming on a table top



Dividing cuts up to 110 mm in height

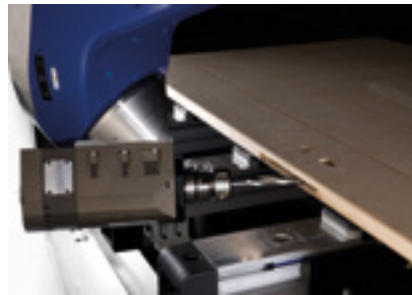

Lock case routing



Square corner routing for a glass rebate



Holes for piling at narrow angles



Routing of a dovetail joint for upright / transom constructions



Trimming of inclined grooves for panel connection



## Versatility - productively manufactured

As demand for individual solutions increases, our technology has all the right answers. Different design styles and structural solutions can be efficiently and economically implemented.

### EDGE FINISH PROCESSING

---



Scraping of mitered edges



Traced flush trimming of overhanging edges on postforming profiles



Perfect edge finish with traced combination flush trimming / scraping unit



laserTec shaped component edging with zero joint





## EDGE BANDING



Gluing unit easyEdge for efficient banding onto shaped components

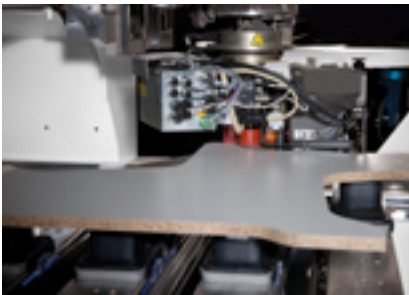

360° edge banding with the powerEdge edge banding unit.



Edge banding for components up to 100 mm in height

## ROUTING

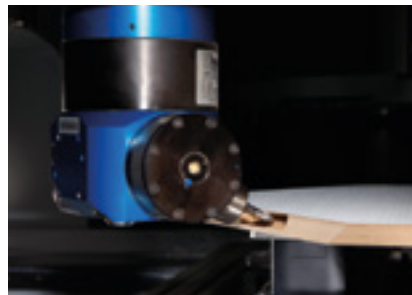

Free angle processing with the FLEX5+ unit



Lock case trimming on front doors

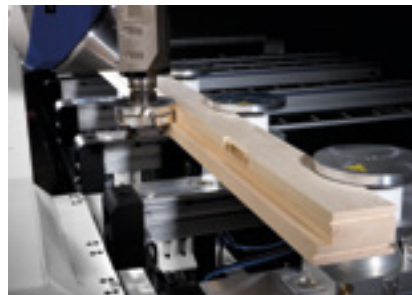

Profiling of frame components

## DRILLING



High-speed drilling technology with grooving saw



Horizontal boreholes for carcass connections

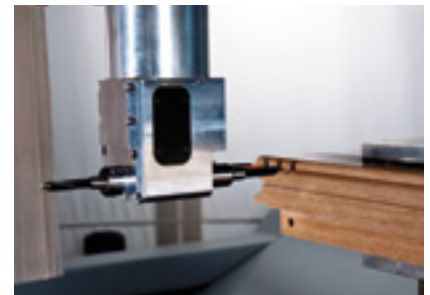

Precise-fitting corner dowel connections

# Scalable performance

Up to three processing units can be individually mounted for fast tool exchange, for instance two trimming spindles and one drilling head in conjunction with two tool changers.

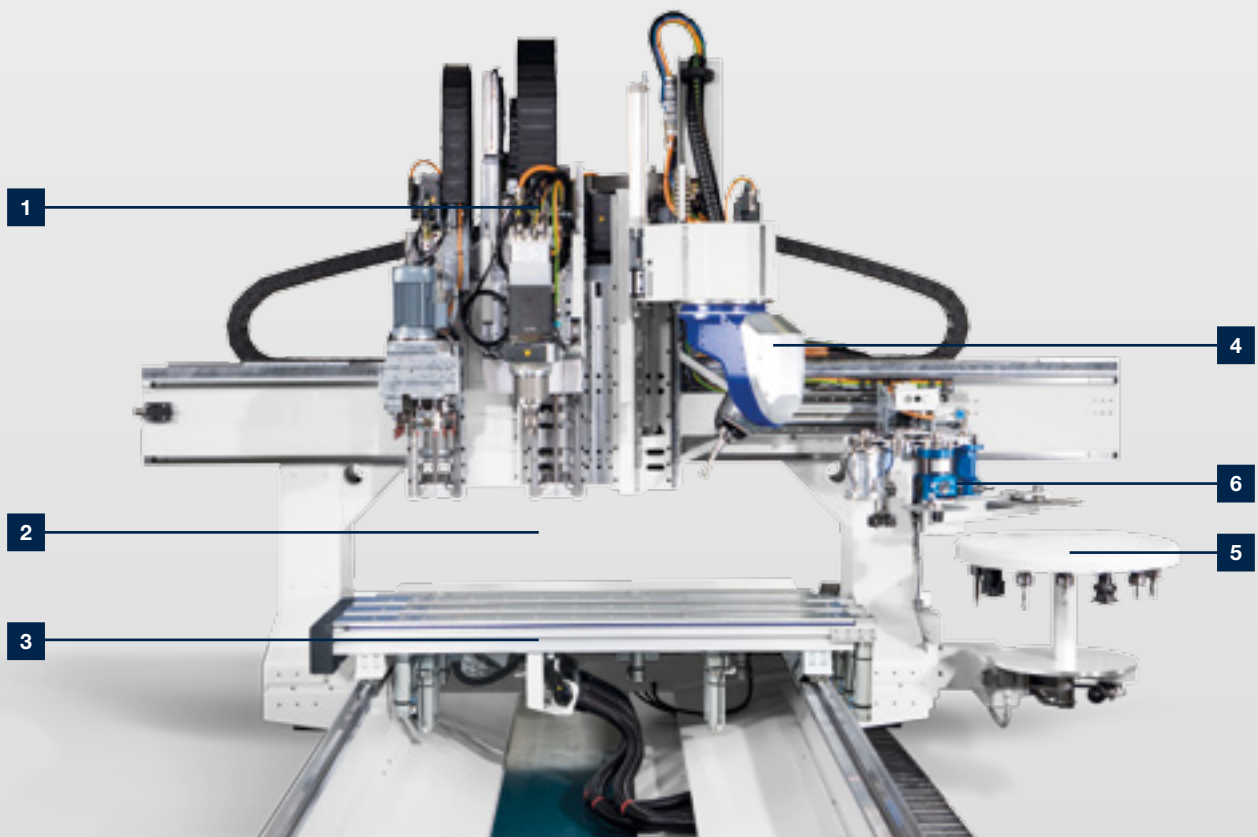

**1** All processing units on separate Z axes: Reduced moving masses, higher machine dynamic response

**2** Real processing height of 300/500 mm, even with long tool lengths

**3** Console table with high-precision linear guides and durable insertion aids

**4** High-performance 4-axis and 5-axis trimming spindles with spindle sensor and encoder feedback

**5** Coupled-motion tool change systems in X for high capacity and fast changeover with both spindles

**6** Tool changer traveling with the spindle going with the tool change during the drilling

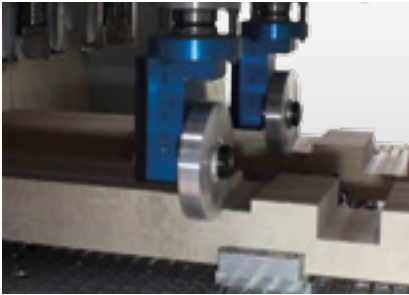

**Synchronous processing:** Synchronous processing of two workpieces clamped a fixed distance apart for maximum output using two trimming spindles with identically equipped tool changers.

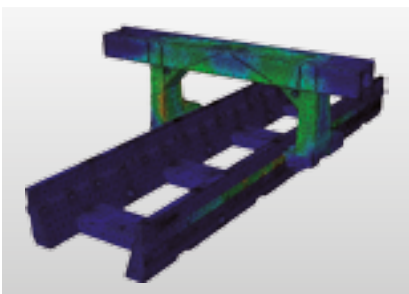

**Highly rigid gantry construction** using the finite element method optimized for a high standard of workpiece quality.



**High-speed tool change:** The installation of two trimming spindles permits the reduction of chip-to-chip times and improved productivity. While one spindle is trimming, the second one is being fitted with the tool required for the next processing operation.



**Tool changer:** Tool storage facility with up to a total of 99 slots offers a basis for the flexible application of different tools and units even with large diameters up to 200 mm. Even saw blades with a diameter of 350 mm for extreme cutting depths and also shift cuts can be fitted (14-slot or 18-slot changer)

# Trimming spindles

Our working spindle technology sets whole new standards, enhancing both the performance and flexibility of our machines. For instance the enormous benefit of a controlled working spindle with electronic speed monitoring. Other

highlights include the vibration sensors for preventing damage to the trimming spindles, the sensoFlex tracing system and 5-axis technology.

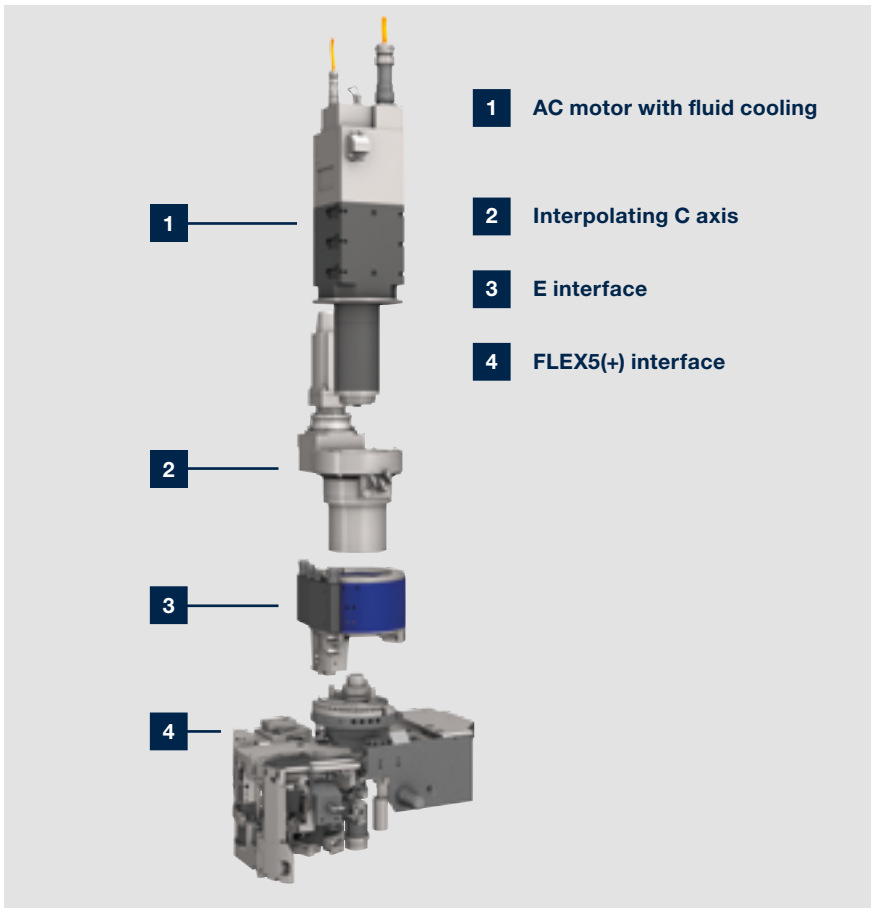

**4-axis trimming spindle with unit interfaces:** The unit interfaces open up practically unlimited production scope. Using patented technologies, the assignment spectrum can be extended at any time.



**DRIVE5C+ five-axis trimming spindle:** Processing of shaped parts with high height through cartesian design and with high-performance processing up to 18,5 kW through double side bearing of the spindle.

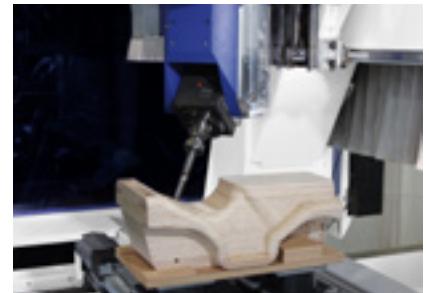

**DRIVE5+ five-axis trimming spindle:** High-performance shaped component processing using a bilaterally supported spindle with Cartesian arrangement.





**Fluid cooling and spindle sensor:**  
Fluid-cooled trimming spindles with hybrid bearings provide a long service life. An additional vibration sensor detects tool imbalance and protects the spindle.



**Minimum quantity lubrication:**  
Machining of aluminium with minimum quantity lubrication through the unit or by means of an external spray pipe at the spindle for maximum care of tools.

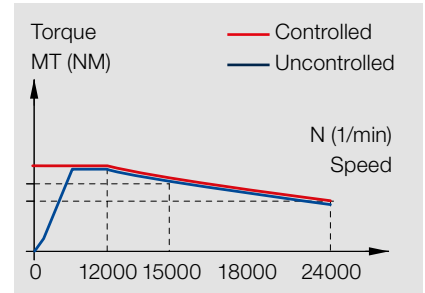

**Vector speed control** by means of encoder feedback at the working spindle ensures full torque right from speed 0.



**Pneumatic interface:** The patented interface with threefold support at all C-axes and five-axis-heads enables the use of traced aggregates e.g. for exact rounding top and bottom independent of thickness tolerances.

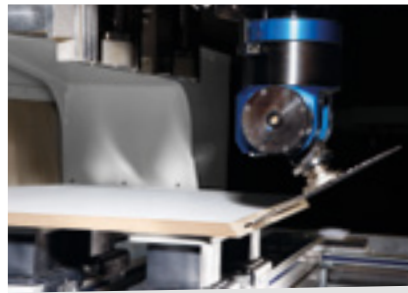

**Sawing, trimming, drilling at any angle:** FLEX5+ unit with automatic angle adjustment and automatic tool change. A unique unit for 4-axis spindles which covers over 90% of five-axis applications.



**sensoFlex tracing system**

- Perfect workpiece quality – the traced spindle compensates any unevenness and unwanted tolerances
- Complete flexibility through the use of tracing for different tools

## Drilling systems to the highest standard

High-speed drilling technology, patented clamping of the spindle and quick-change system for tools. Precise drilling, fast cycle speeds, maintenance-free and durable design.



**Drilling head V9/H4:** HIGH-SPEED drilling head up to 7500 rpm with 9 vertical spindles and 4 horizontal spindles.



**Drilling head V17/H4:** HIGH-SPEED drilling head up to 7500 rpm with 17 vertical spindles, grooving saw and 4 horizontal spindles with 0/90° swivel facility. Fast drilling including grooving in the X/Y direction.

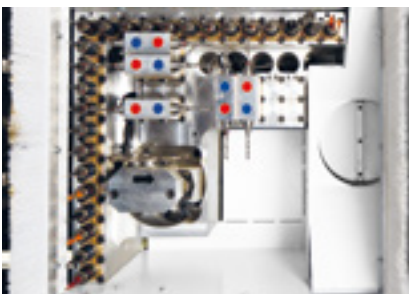

**Drilling head V25/H10:** HIGH-SPEED drilling head up to 7500 rpm with 25 vertical spindles, 6 horizontal spindles in the X direction and 4 in the Y direction including grooving in the X direction.



**Drilling head V12/H4:** HIGH-SPEED drilling head up to 7500 rpm with 12 vertical spindles, grooving saw and 4 horizontal spindles with 0/90° swivel facility. Fast drilling including grooving in the X/Y direction.

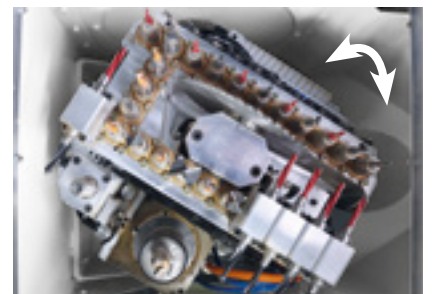

**Multi Processing Unit (MPU):** The Multi Processing Unit has a stepless 360° swivel action. This allows the saw and also all 20 vertical and 10 horizontal spindles to be applied at any optional angle. An optional trimming spindle attachment saves tool changes and enhances productivity.

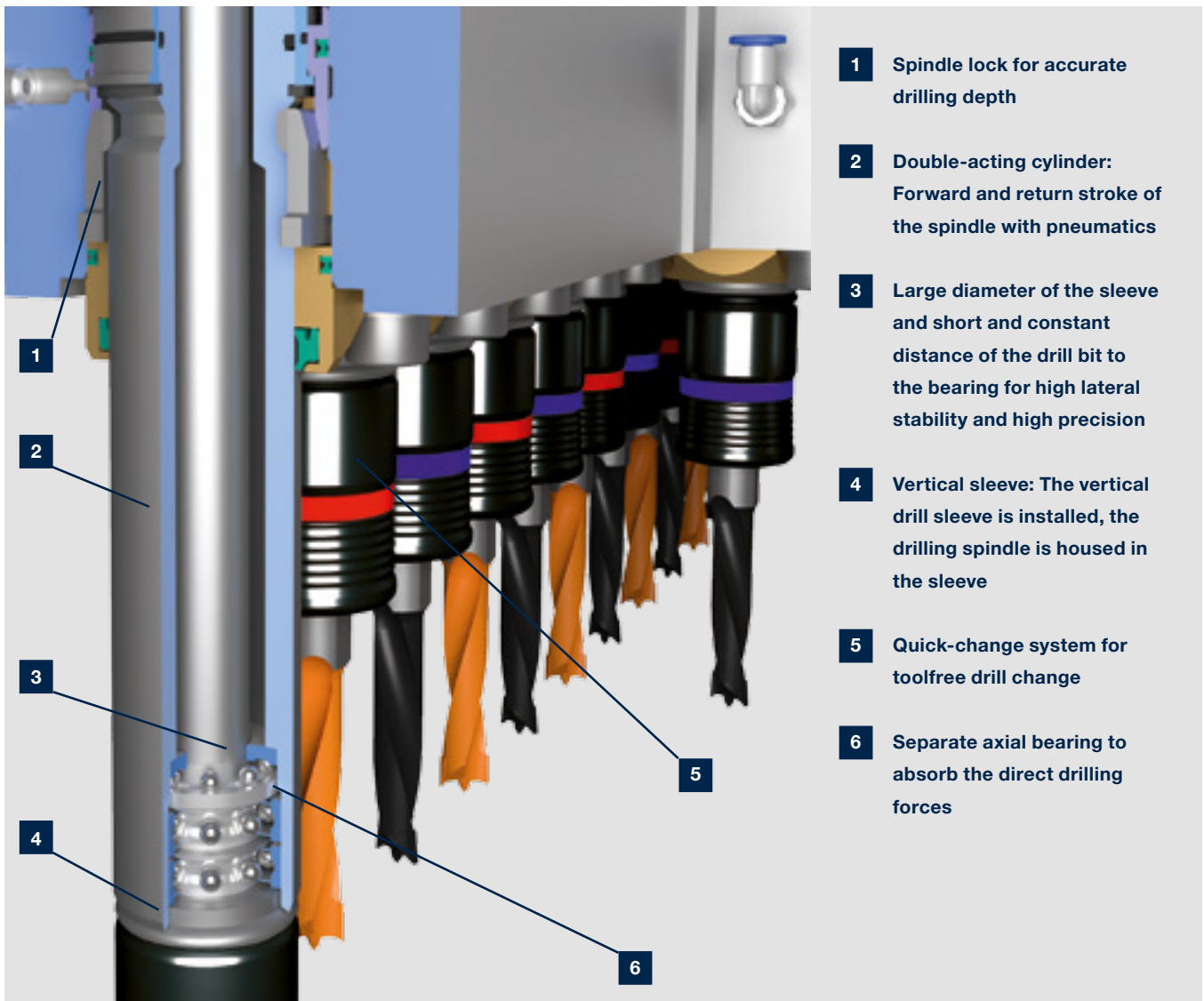

- 1** Spindle lock for accurate drilling depth
- 2** Double-acting cylinder: Forward and return stroke of the spindle with pneumatics
- 3** Large diameter of the sleeve and short and constant distance of the drill bit to the bearing for high lateral stability and high precision
- 4** Vertical sleeve: The vertical drill sleeve is installed, the drilling spindle is housed in the sleeve
- 5** Quick-change system for toolfree drill change
- 6** Separate axial bearing to absorb the direct drilling forces



**2+2-spindle drilling/trimming unit:** The 4-sided spindle outlet makes available four different drilling and trimming tools without tool change. Continuous shaft for greater rigidity and processing without change of direction when using clockwise and counterclockwise rotating tools, e.g. when trimming out recesses for door hinges.

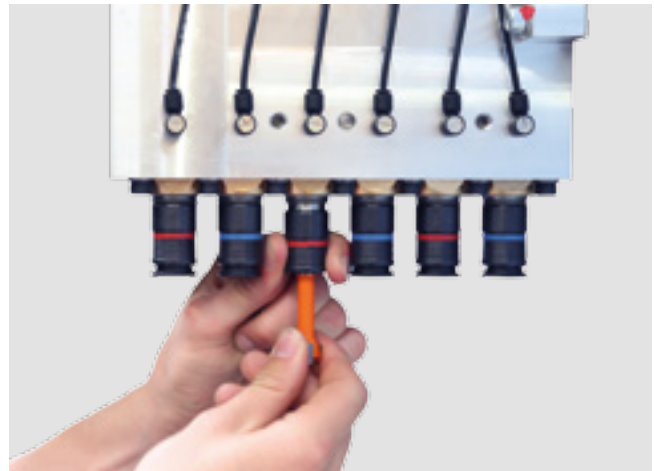

**Quick-change system** Patented quick-change system for drill bit changeover without tools to reduce set-up times.

# Tool change systems

Simple flexibility. All neatly stored away for quick access. Tool changers provide the basis for the flexible deployment of tools and units, also for large saw blades or heavy processing tools.

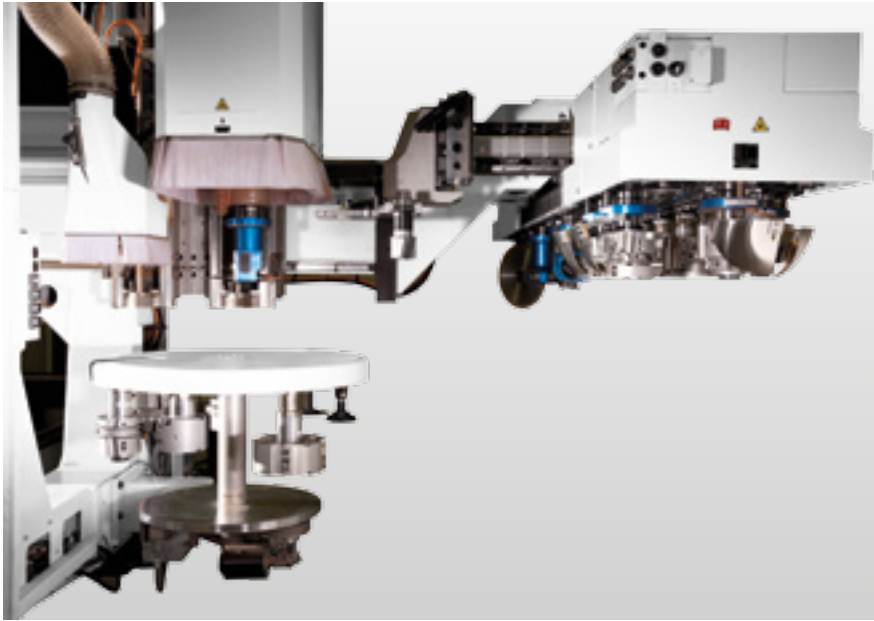

**Systems for all requirements:** Tool changers with up to 99 (72 + 18 + 9) slots provide the basis for the flexible deployment of tools and units.

**72-/ 30-slot chain changer:** High capacity and extremely fast changeover times with prelocated double-action gripper.



**72-/ 30-slot chain changer mounted underneath:** In double-spindle machines, because the tool changer is positioned underneath, the same changer can be accessed by both trimming spindles.



**18/14-slot plate changer:** For tools and units with a diameter of up to 200 mm. A saw blade with a diameter of up to 350 mm can be accommodated in the changer.

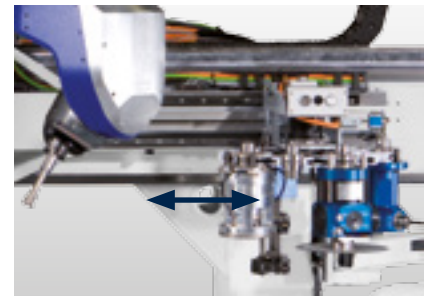

**10-slot plate changer:** Tool change during drilling or processing with the 2. spindle with changer traveling with the spindle. For tools and aggregates with a diameter up to 180 mm.



# Units

Excellent processing quality and top marks in terms of speed. HOMAG processing units make available a range of innovative technologies. They can be combined

and coordinated precisely to address your own specific application situation. Even special, non-standard assignments are reliably and efficiently processed.

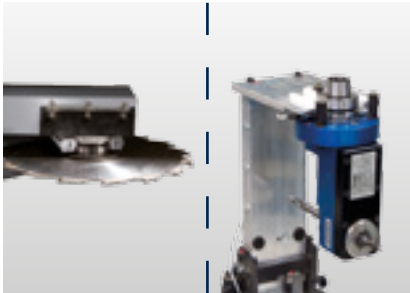

**Pick-up station & tool transfer station:** An additional pick-up station for saw blades with a diameter of 350 mm saves space in the tool changer. A tool transfer station increases operating convenience and helps prevent errors in the equipment of tool changer slots for improved safety.

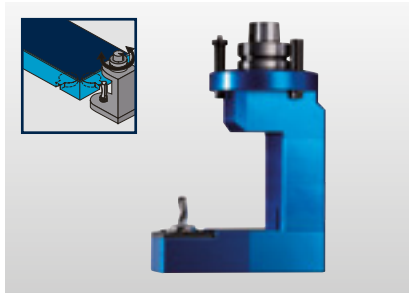

**Underside trimming unit:** For trimming and drilling the underside of workpieces, e.g. recesses for kitchen worktop connectors or hardware holes in the edge area without the need to flip the workpiece. The maximum distance to the workpiece edge is 110 mm and the maximum tool projection is 30 mm.



**Vertically traced trimming unit:** By means of a tracing ring with dia. 70 mm / dia. 130 mm, or tracing pad, it is possible to perform operations such as pocket trimming in precise relation to the workpiece surface. When connecting kitchen worktops, tracing guarantees an offset-free transition by precise trimming of grooves for the tongue and groove joint.



**Linear changer:** Additional tool change magazine, with 8/9 slots and integrated tool transfer station, laterally mounted. The magazine also accommodates the pickup station for the optional easyEdge unit.

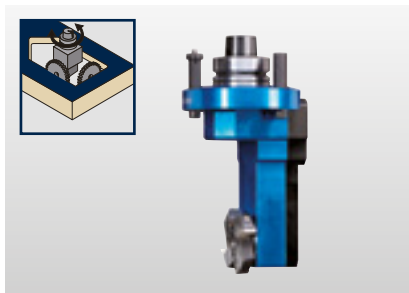

**Corner notching unit:** For the production of right-angled, splinter-free, sharp-edged recesses, for example for efficient processing of door glazing cutouts, sink cutouts in kitchen worktops.



**Measurement probe:** Tracing system to determine the actual X, Y and Z axis measurement of relevance for processing with automatic correction offset in the processing program.

## Edge banding with the CENTATEQ E-500: perfect edge quality with easy usage

HOMAG processing centers with edge banding units are real all-rounders. With them several working steps from panel sizing, profiling and drilling to edge banding can be executed on one machine.

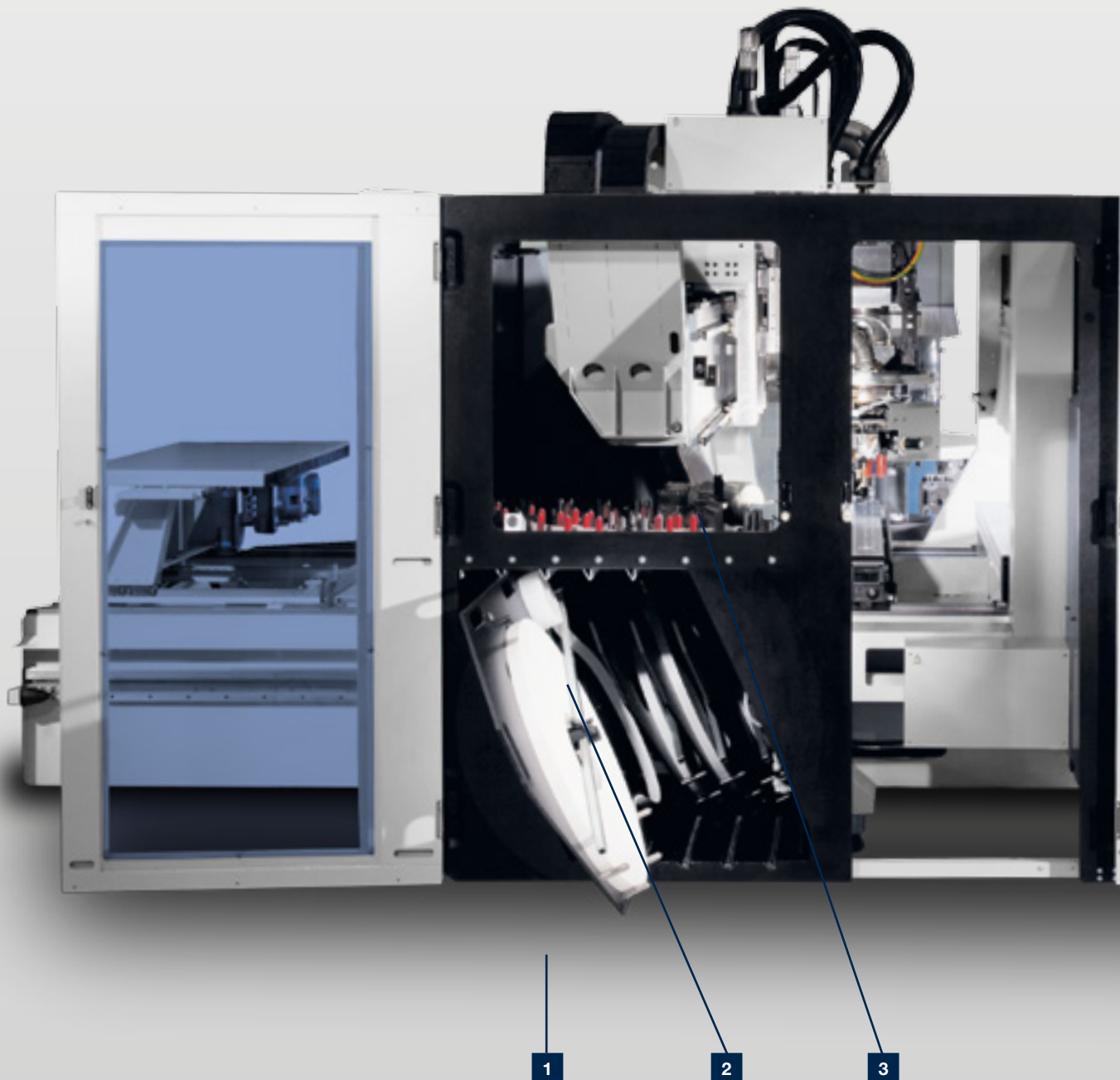

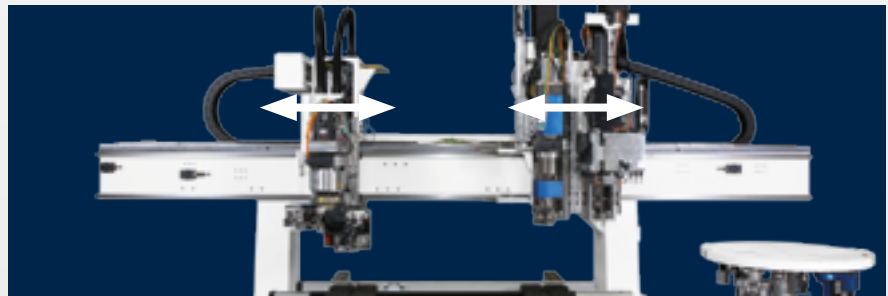

High output with low space requirements: Independent Y axis on one side of the portal for gluing unit and trimming spindle/drilling head.



- 1** External preparation of edges due to exchangeable coil plates.
- 2** Comfortable and rapid insertion and changing of edging materials by installation of the edge magazine at the front side of the machine.
- 3** Simple top-up of hot-melt glue, simple monitoring and servicing of the gluing section.
- 4** Clear visual access in the processing through large sight window.
- 5** Optimal access to the processing units by a large access door.

## Innovative edge banding technology for all

HOMAG processing centres are ideally prepared for the use of ultra-modern edge banding technologies. The edge banding units are offered in a variety of performance categories and can be ideally coordinated to address your

individual production requirements. Their patented electronic interface makes them easy to operate and ensures optimum control precision.

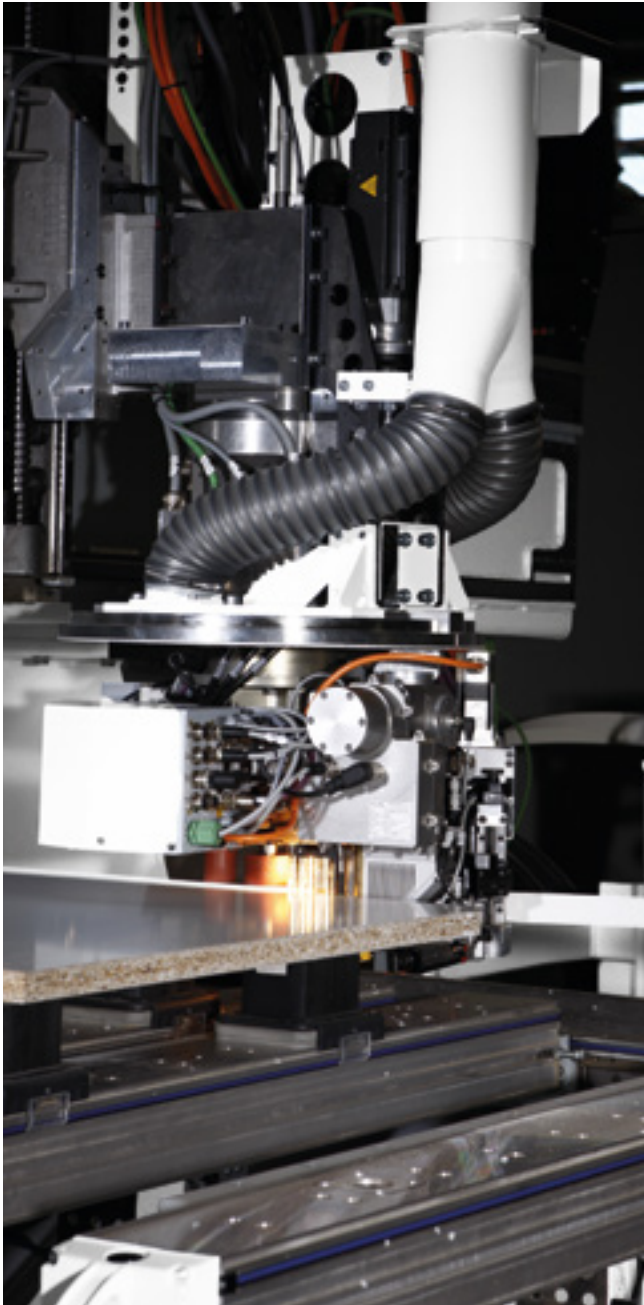

**laserTec edge banding unit:** Edge banding to a previously unattainable standard of quality: HOMAG laserTec – the quantum leap for furniture production.

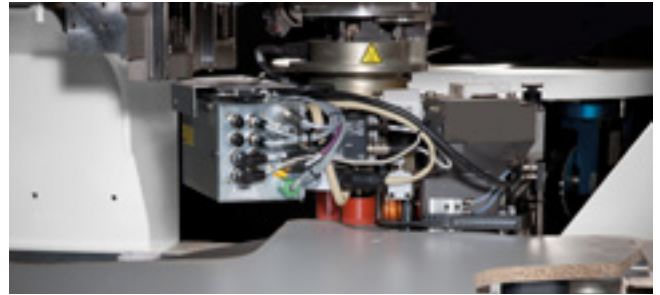

**powerEdge edge banding unit:** The powerEdge edge banding unit is the culmination of experience gathered from over 2,000 processing centres for edge banding and forms the basis for a complete family of edge banding units to cover a wide variety of applications.



**easyEdge edge banding unit:** The world's smallest edge banding machine – affordable, simple, efficient. The universal solution for edging small workpiece quantities with veneer edges, ABS edges, PP edges, melamine edges and thin PVC edges. In conjunction with a manual snipping unit, it is even possible to perform 360° butt joint edge banding in craftsmanship quality.

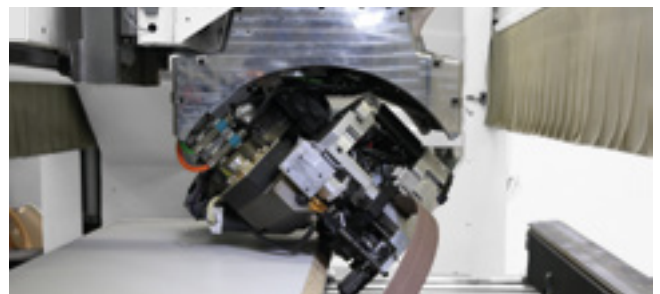

**Inclined edge banding:** At any optional angle of inclination. The automatic unit adjustment facility allows both shaped edges and inclined edges to be applied to the same workpiece.



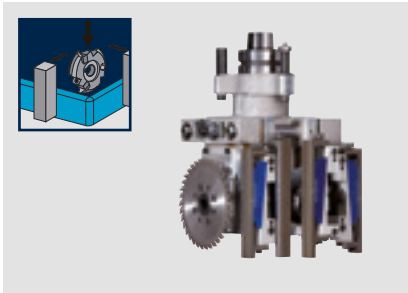

**Combined snipping and corner**

**rounding unit:** Already edged rectangular workpieces are often finish processed on a processing centre, for instance to produce bevels or rounded contours. For finish processing, this patented unit provides, alongside traced cross-cutting of overhanging edges, also precise corner rounding of edges up to a thickness of 3 mm at a 90° workpiece corner.

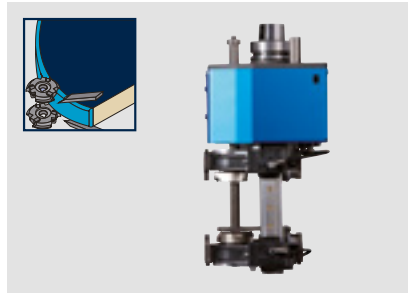

**Combined flush trimming - scraper**

**blade unit:** Combination unit for flush trimming the edge overhang and for scraper blade finishing. This removes cutter marks and other unevenness on the edge profile. Three-sided unit tracing compensates for workpiece and edge tolerances and guarantees a high standard of processing quality.

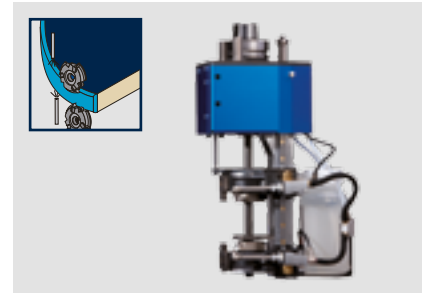

**Flush trimming unit with separating**

**agent:** Separating agent application during flush trimming reduces the amount of glue residues on the workpiece and often eliminates the need for scraping the glue joint with a glue joint scraper blade unit (depending on the glue and edging type and on the quality expectations).



**Horizontally traced trimming unit:**

By means of a tracing roller, horizontal trimming operations are performed precisely relative to the workpiece surface, e.g. during flush trimming of overhanging edges on the postforming profiles of a kitchen worktop. The diameter of the tracing roller and trimming tool are coordinated, generally to 20 mm.

## Fast, neat and convenient – the console table

The classic with the dual-circuit vacuum system: Easy, practical and fast: Through the patented system of the magnetic valves the vacuum cup and other clamping devices can be put on the console in any number and on any position. Not used suction points do not need to be

covered. Unified height for all clamping devices allow to combine them among themselves. The K-table is the ideal solution, if flexibility, secure clamping of different parts and fast exchange are required.

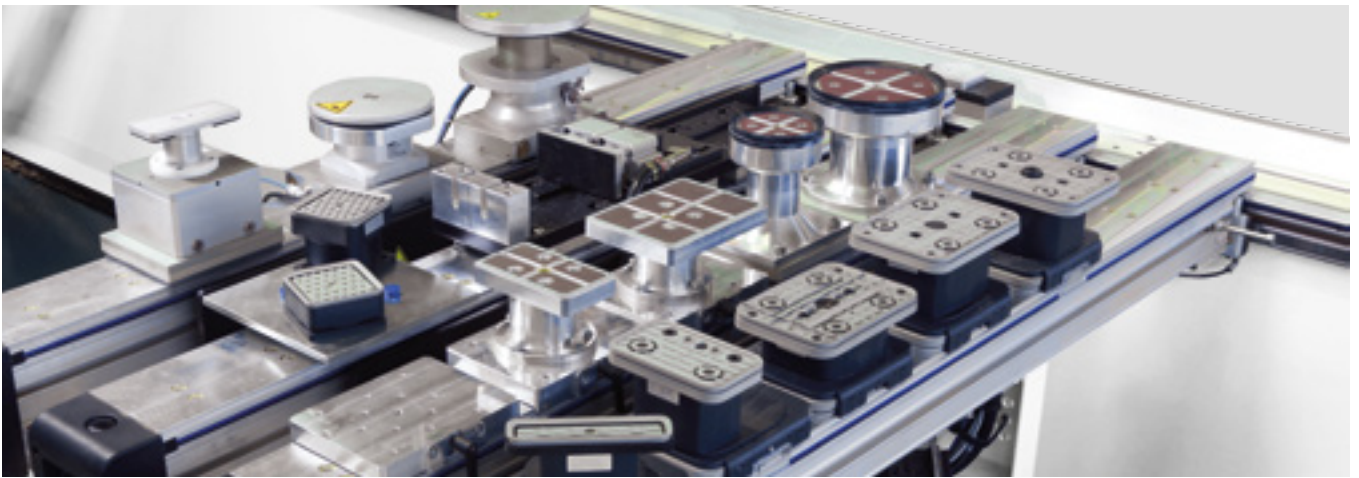

**Linear guide and insertion aid:** Simple handling by consoles with high-precision linear guides and durable insertion aids with two pneumatic cylinders. Vacuum and compressed air connections are integrated in the consoles for pneumatic clamps and clamping templates.



**Bolts with end position scanning and for laminate overhang:** Stop bolts with end position monitoring to protect tools, units and machine operating staff. Exchangeable stops specifically for workpieces with laminate overhang.

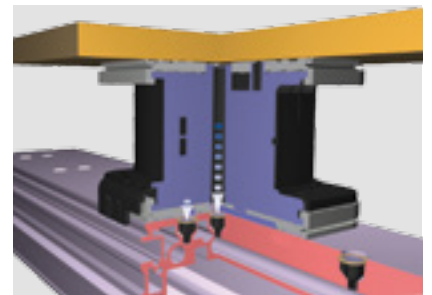

**Dual circuit vacuum system:** Exclusive vacuum clamping technology with patented double sealing lip for the stepless displacement of clamps along the console. The first clamping circuit fixes the clamps in the console and prevents unwanted displacement. The second then holds the material firmly in position.

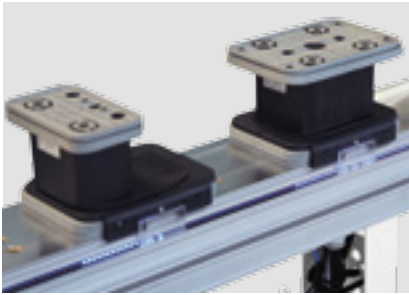

**LED system** – both the fastest and safest positioning system for consoles and clamping elements (patented).



**Suction cups** are displayed using a laser beam (cross hairs). The workpiece contour can be “travelled” as a positioning aid for freeform part



**Laser projection** of the clamps and the workpiece contour for optimum utilization and simple positioning of raw parts which cannot be aligned at the stops.



**powerClamp:** Manual clamping fixture powerClamp for straight and curved parts. Ideal for all arched, narrow and frame parts.

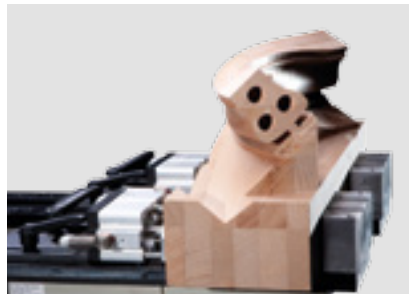

**Clamping device** Uprights and staves can be securely clamped in no time using this clamping device.



**3-step clamp:** Highly rigid 3-step clamps with extreme clamping height for precise complete processing of window and front door components without subsequent outside moulding and profiling.

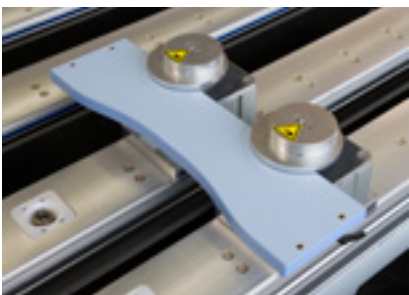

**Multiclamp for dual circuit vacuum system:** Vacuum actuated clamping element for clamping strips and staves



**Matrix adapter plate:** Highly flexible clamping systems offer secure fixture even when working with filigree workpieces. The matrix adapter panel even permits shaped components to be “cut to size” with optimized cutting waste on a console table machine using the nesting process.



**Vacuum clamps made of aluminum:** Vacuum clamp in aluminium with additional mechanical clamping operation at the console for engaging solid wood parts. The suction plate can be rotated and also exchanged, and is lined with emery cloth.



## Automatically in the right position: The A table

The A table is the key to greater convenience and automation. The program-controlled positioning of consoles and clamping elements allows batch size 1 operation without

manual intervention and allows workpieces to be moved apart after the execution of a dividing cut.



**movePart:** The clamps move apart automatically in the program sequence after separation for complete processing.

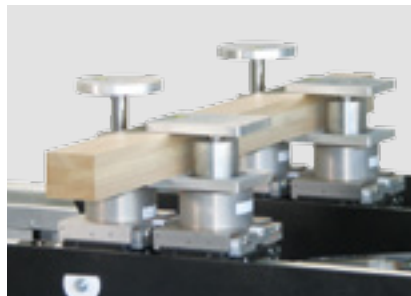

**powerClamp:** powerClamp clamping fixture for straight and curved parts. Ideal for all arched, narrow and frame parts. Also with automatic reclamping for 5-sided processing.



**Clamping device:** Uprights and staves can be securely clamped in no time using this clamping device.



# Versatile application: the matrix table

The grooved aluminium matrix table permits the positive locking of clamping elements and consequently reliable workpiece fixture even where high hogging forces are involved. The transmission of vacuum through the table construction optimizes distribution of the vacuum, reduces

leaks and transmission losses and does away with the need for complex installations. Using different clamps with variable clamping heights, the matrix table is also suitable for the use of units.

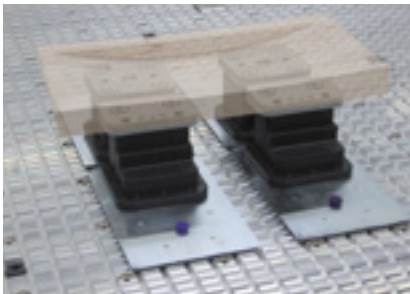

**Maxi-Flex system:** Freely equippable system base plate for vacuum clamp.

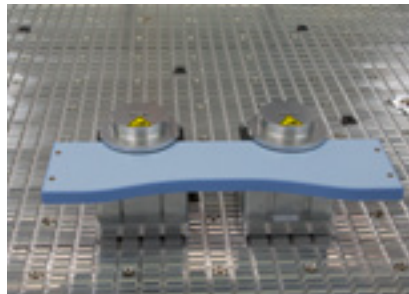

**Multiclamp:** Vacuum actuated clamping element for clamping strips and staves.

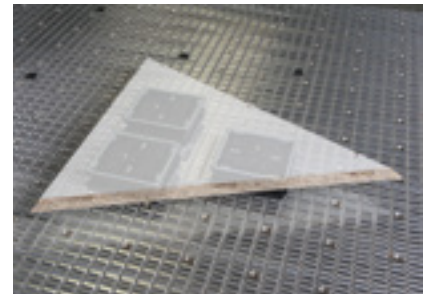

**Vacuum clamp:** Vacuum clamping elements for insertion in the grooves of the grid table.

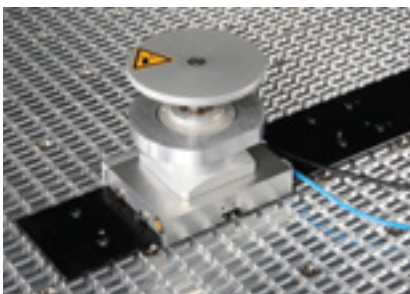

**Rail for powerClamp clamping elements:** Rail for fixture of the powerClamp clamping elements from the K table range for pneumatic clamping of wooden staves, arch parts or stacks of panels. Mechanical fixture of the rail in the system groove is possible in both directions on the table. Alignment of the clamping elements with stop pins.



**Fixture using non-standard clamps:** The aluminium grid table with dovetail guides guarantees precise, positive fitting clamping element fixture.

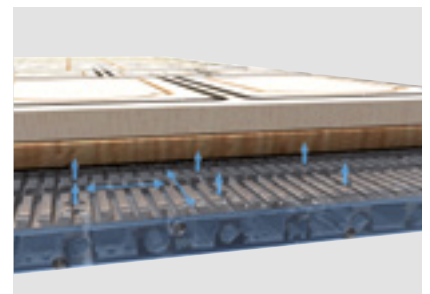

**Vacuum grid table with air cushion function:** The vacuum transmission is integrated in the design of the aluminium grid table. Division into zones and efficient vacuum pumps ensure reliable clamping, even for nesting processes with underlay panels. The air cushion function makes light work of handling large-format panel-shaped workpieces.



## Tailor-made clamping solution

The possibilities of our processing centers do not end in the catalogue. The tables and basic components are the basis for your customized solution: A variety of standard clamping elements, specific adapted clamping devices for your requirements or your own devices are also possible as workpieces in the XXXL-size, which also can have 10 m length or 3 m depth.

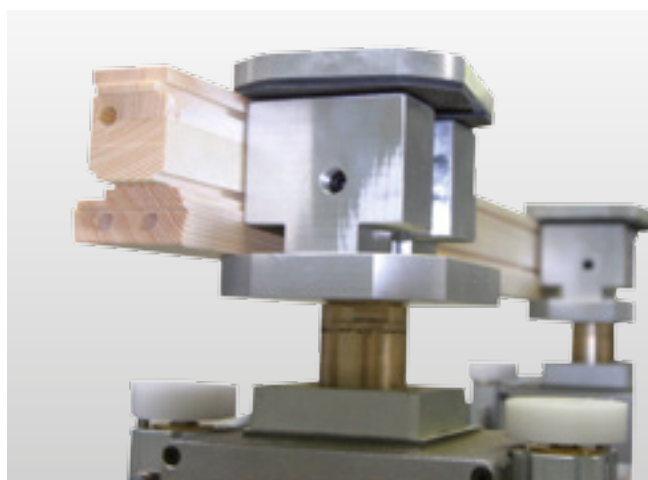

**Narrow sash bars and thick profiles:** No limits for window manufacturing: The HOMAG 3-step clamping system also fixes thick profiles up to 120mm (option 150mm) and narrow sash bars secure and precise.

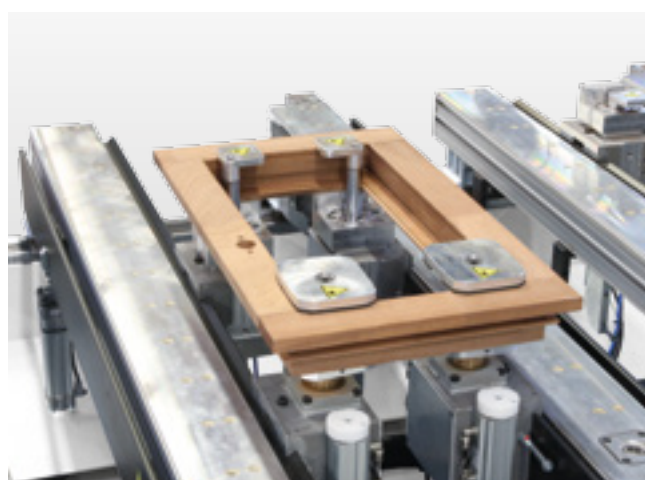

**Sash outside profiling:** Also suitable for the classical production: With swing clamps sashes can easily be inserted, aligned and hold.

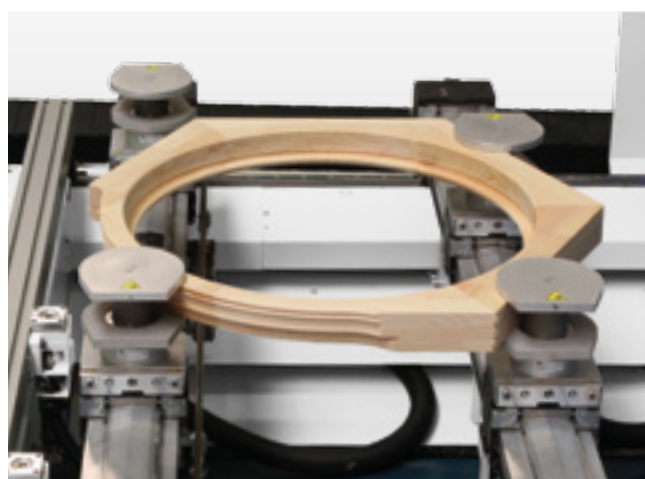

**Round windows processing:** Automated complete processing of round windows without manual intervention in the process through special machining sequence.

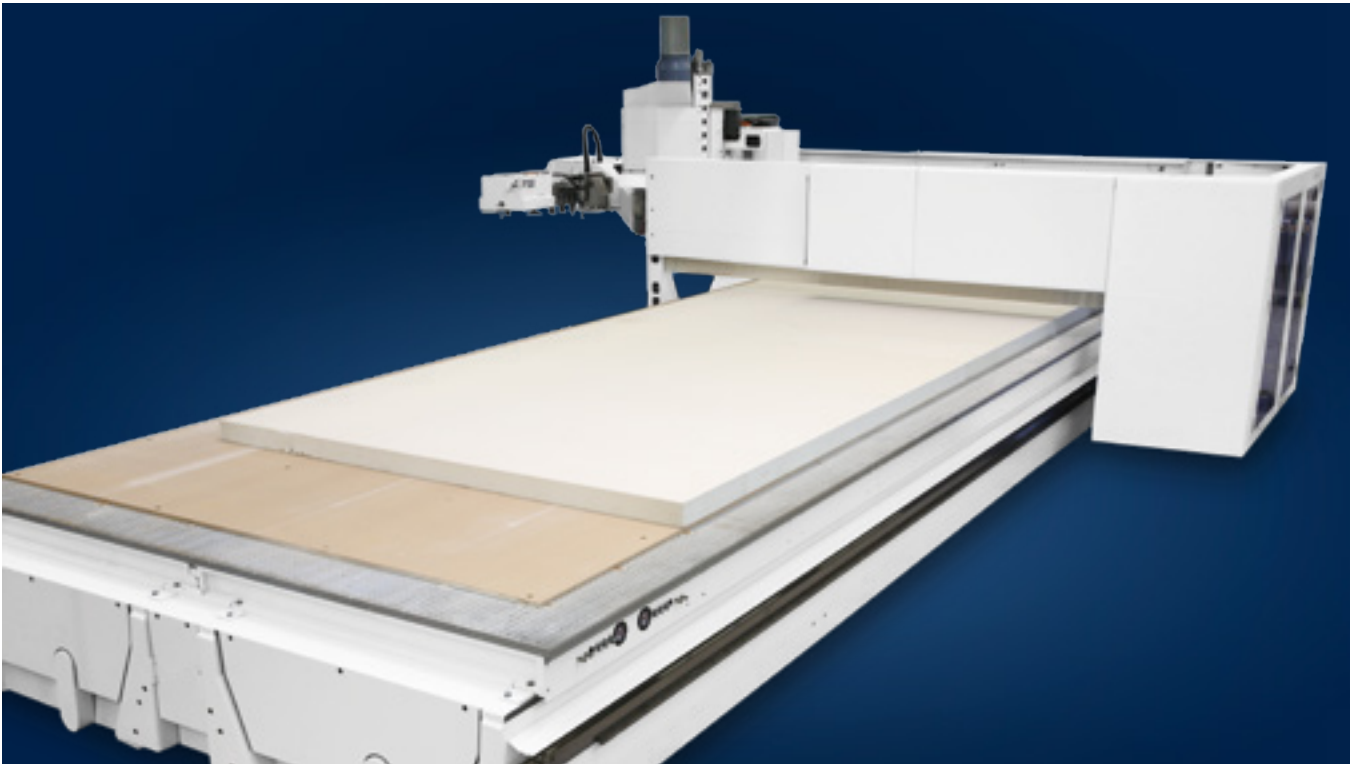

**Machine depth XXXL:** Components until 3000 mm width for the board processing for construction.



**Clamping fixture for facings:** Vacuum clamping fixture for a pair comprising rebate and ornamental facings according to customer design. Mounted on a base plate module.



**Clamping fixture for round pipes:** Clamping fixture for 5-axis processing of round plastic pipes.



**Block clamp:** Adapted block clamping fixture for round timber elements.

## Better the automatic way: Made to measure manufacturing solutions

Using intelligent solutions, we turn CNC processing centres into complete production cells with automatic material handling and specific supplementary functions. This is how to make optimum use of your machine and achieve maximum output. All these benefits are made possible using innovative system technology based on long years of experience in the construction of complex plants of all different sizes all over the world.

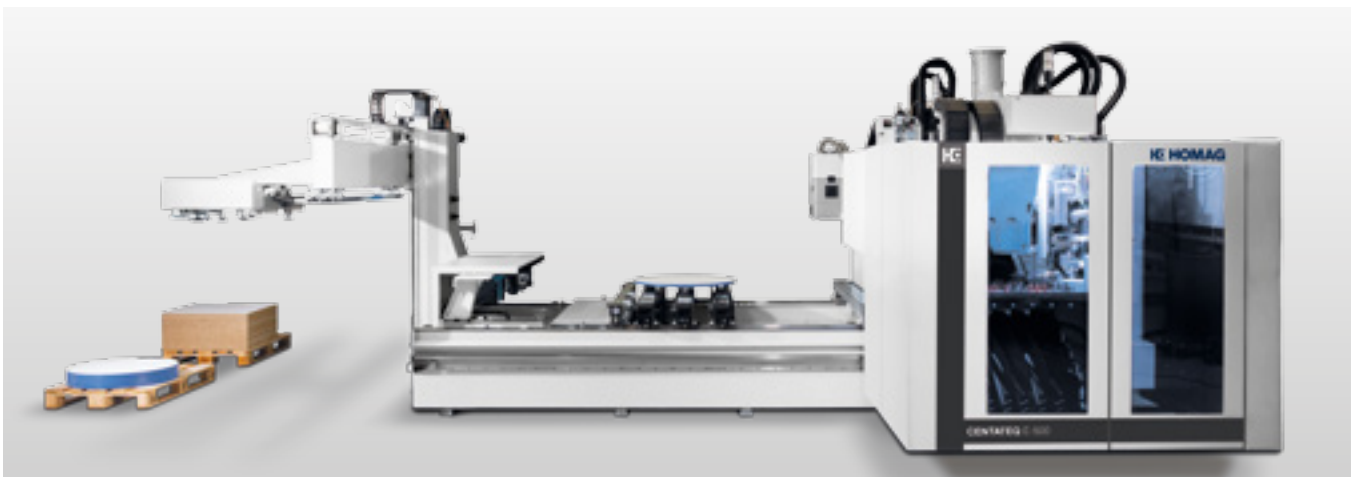

**TBA feeder attachment:** Simple, space-saving entry into the world of automation with the TBA feeder attachment mounted laterally at the machine. Reliable handling, precise positioning and integrated workpiece cleaning. Extreme operating and programming simplicity through direct use of the woodWOP processing program.



**Gripper technology with a system:** Integrated sensor functionality prevents errors as a result of adhering parts, while monitoring that workpieces are correctly picked up.

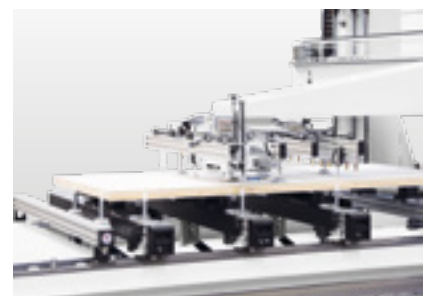

**Alignment against stops:** Articulated suction grippers permit precise positioning of workpieces against the stops on the machine table.





**Robot handling systems:** Unlimited workpiece handling with different layer patterns, storage positions, alignment and flipping. Supplementary functions such as labeling, position measurement or cleaning can be simply integrated.



**Handling automation:** safe, material friendly and economical.

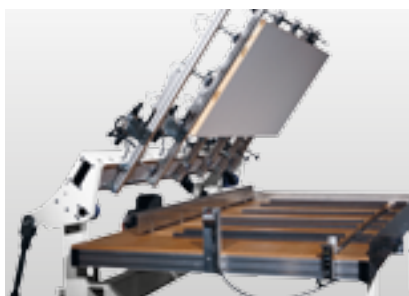

**Alignment, validation and turning over:** Free robot movement in up to 6 axes permits additional functions to be simply integrated into the process (e. g. turn over function for processing on both sides).



**Cell control and visualization:** For reliable, efficient cell operation, in particular with batch size 1 production, HOMAG offers a simple, intuitively operated user interface for visualization and control of the entire cell.

# HOMAG software: The basis for simple, efficient operation

Our processing centres are one thing – the software needed for their convenient, simple operation day in, day out is another. This is why HOMAG software guarantees extreme flexibility and operating reliability. A matter of course at HOMAG: interfaces to external programming and design systems, help programs for interleaving and modules to help you monitor your machine and track its performance. powerTouch is the latest operating philosophy of the HOMAG. It combines design and function to create a completely new control generation. The new system is characterized by the full HD multitouch monitor, ergonomic touch operation, simple navigation and the standardized user interface.

## WOODWOP - STREAMLINED OPERATIONS THROUGH FAST PROGRAMMING

- **Fast, intuitive operation based on simple, direct navigation**
- **Free use of variables for flexible variant programming**
- **Fast creation of own subroutines**
- **Increased programming reliability through 3D images of workpieces, processing and clamping equipment. High degree of operating convenience due to freely configurable windows, multiscreen capability, language-neutral input screens, help graphics and much more.**
- **Biggest forum for CNC programming in the Internet: [www.forum.homag.com](http://www.forum.homag.com)**

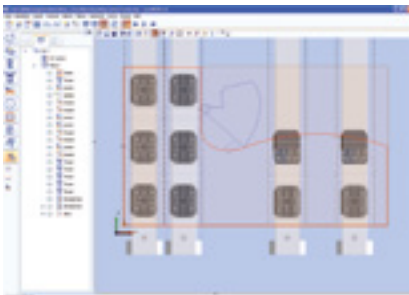

### woodWOP Wizard – your automatic route to the perfect edge

- Automatic generation of the complete processing sequence for edging
- Generation of all processing steps such as rough trimming, jointing trimming, edging, snipping, flush trimming and scraping
- Takes into consideration workpiece geometry, edge transitions and edge type
- Time savings of over 90 % compared to conventional programming

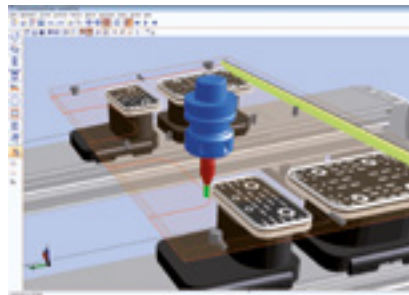

### CAD plug-in

- CAD functions integrated directly in woodWOP
- CAD drawings can be generated directly at the machine and at the production engineering workstation
- Import of CAD drawings in DXF format
- Intuitive operation and fast familiarization with a standardized user interface

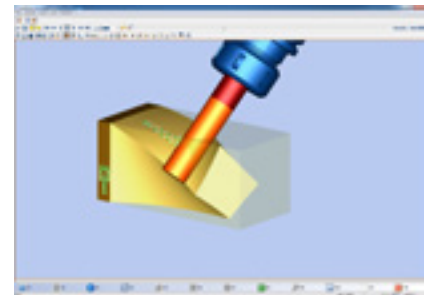

### woodWOP CAM-Plugin

- CAD/CAM functions integrated directly in woodWOP
- Fast constructing of 3 surfaces in CAD-Plugin or through import of 3D models
- Automatic generation of tool paths for roughing, smoothing and sizing of 3D objects
- Safe working as the tool paths and travelling ways are graphically indicated and simulated in woodWOP

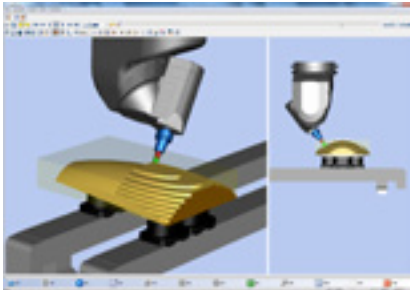

**woodMotion - processing program simulation**

- Graphic simulation of the CNC program at the office PC
- Reduction of machine running-in time due to optimum program preparation
- Simulation of 5-axis processing including material removal
- Display of real processing time
- Collision monitoring between the tool and clamping elements



**woodScout - help in your own language**

- Optional high-performance diagnostic system
- Graphic display of the fault location at the machine
- Clearly understandable plain text error messages in different languages
- Learning capability through the assignment of root causes and remedial actions (expert knowledge)

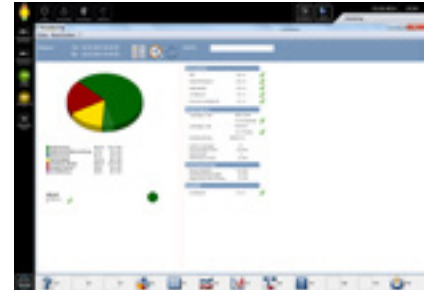

**Machine data acquisition MDA – for a productive environment**

- Registration of piece numbers and ACTUAL operating times at the machine
- Integrated maintenance instructions for the optimum time and quality-based planning and execution of maintenance work
- Optional professional version allows detailed breakdown and logging of the recorded data

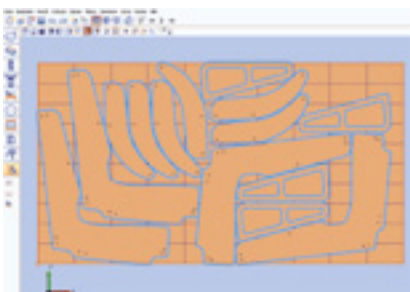

**Cut Rite optimization Nesting**

- Nesting software for automatic interleaving of workpieces on a raw panel
- Material cost savings due to optimum utilization of the raw panel
- Individually adjustable optimization parameters help reduce overall processing time and take care of process reliability

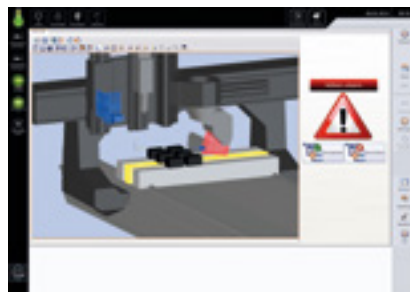

**collisionControl – permanent safety for your machine**

- Monitors possible collisions between machine components and clamps during processing
- Automatic machine stop in the event of an impending crash situation
- Machine shown as a moving 3D model in live mode



**Graphical tool database**

- Dimensioned graphics for simple set-up and management of tools and units
- 3D view of tools



## HOMAG Life Cycle Services

The sale of our machines comes with all-in optimum service backup and individual advice. We support you with service innovations and products which are especially tailored to your requirements. With short response times and fast

customer solutions we guarantee consistently high availability and economical production – over the entire life cycle of your machine.



### Remote Service

- Hotline support via remote diagnosis regarding control, mechanics and process technology. Thus the on-site service can be reduced by 90 %!
- Mobile applications such as ServiceBoard reduce the costs through fast help in case of troubles by mobile live video diagnosis, online service message and the online spare parts shop eParts



### Spare Part Service

- Identify, request and order spare parts around the clock via [www.eParts.de](http://www.eParts.de)
- Local availability of parts offered by our sales and service companies as well as sales and service partners all over the world
- Reduction of downtimes through defined spare parts and wear parts kits



### Modernization

- Keep your machinery up-to-date and increase your productivity as well as your product quality. This is how you can meet tomorrow's requirements today!
- We support you with upgrades, modernization as well as individual consultancy and developments





**HOMAG Finance**  
– precisely the right financing

- We offer you tailored financing proposals for your machinery or plants. Our financial advice goes hand in hand with our expertise relating to technical questions. Your personal contact person will take care of the whole process
- The benefit for you: The ability to invest without delay in new technologies and remain financially flexible.

1,200

Service employees around the world

5,000

customer training sessions per / year

90%

less on-site-services through successful remote diagnosis

>150.000

machines, all electronically documented in 28 different languages – in eParts



**Trainings**

- The trainings perfectly suit to your requirements. Through this your machine operators can operate and maintain the HOMAG machines optimally.
- The trainings also include customerspecific training documents with practice-proven exercises

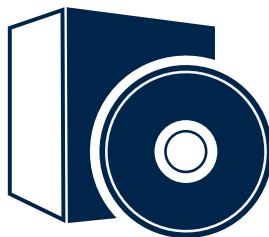

**Software**

- Telephone support and consultancy through software support
- Digitalization of your sample parts via 3D scanning saves time and money compared to new programming
- Subsequent networking of your machinery with intelligent software solutions ranging from construction to production



**Field Service**

- Increased machine availability and product quality by certified service staff
- Regular checks through maintenance / inspection guarantee the highest quality of your products
- We offer you the highest availability of technicians in order to reduce downtimes in case of unpredictable troubles

# Technical data

## CENTATEQ P-500|600, CENTATEQ E-500

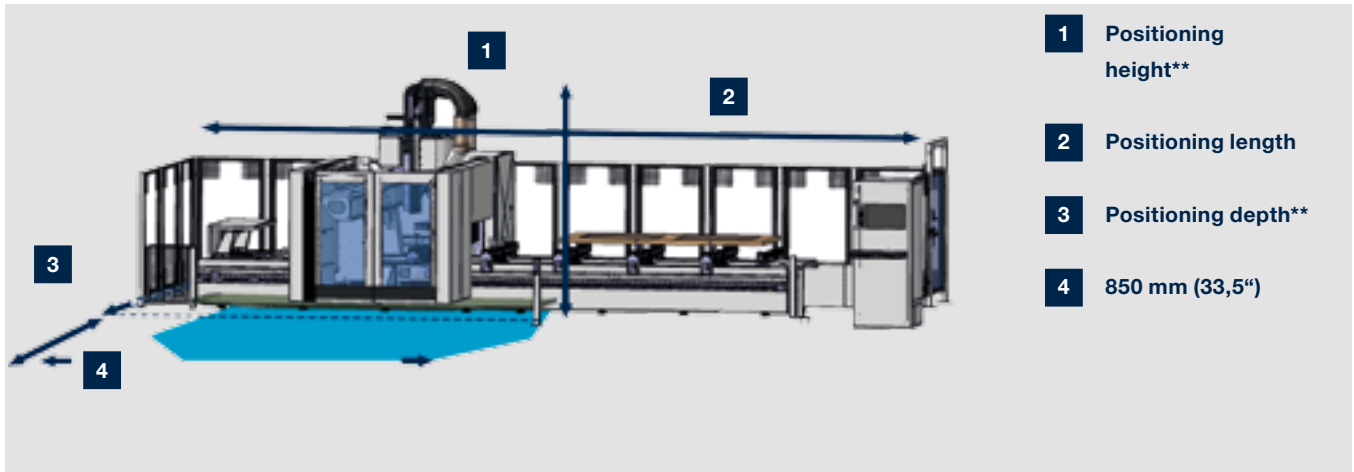

### WORKING DIMENSIONS

Machine type	Y = Workpiece width [mm]			
	A = 0° all units, A = 90° with tool length 230 mm	A = 0° with tool diameter 25 mm		Gluing (CENTATEQ E-500)
	Front stop	Front stop	Rear stop	Rear stop
/12	1100 (43,3")	1325 (52,2")	1550 (61,0")	1550 (61,0")
/15	1450 (57,1")	1675 (65,9")	1900 (74,8")	1900 (74,8")
/19	1800 (70,9")	2025 (79,7")	2250 (88,6")	2250 (88,6")
/29	2800 (110,2")	3025 (119,1")	3250 (128,0")	--

Machine type	Machine type
P-500	300 (11,8")
E-500	
CENTATEQ P-600	300 (11,8")
	500 (19,7")

Machine type	x = Workpiece length [mm]	
	Individual processing	Alternating processing CE*
/33	3300 (129,9")	1025 (40,4")
/40	4000 (157,5")	1375 (54,1")
/60	6000 (236,2")	2375 (93,5")
/74	7400 (291,3")	3075 (121,1")



SETTING UP DIMENSIONS						
Model	Positioning length [mm]				Positioning depth [mm]**	Positioning height [mm]**
	33	40	60	74		
<b>P-500</b>	7450 (293,3")	8150 (320,9")	10150 (399,6")	11550 (454,7")	4750 (187,0")	2980 (117,3")
<b>/12</b>						
<b>/15</b>	7450 (293,3")	8150 (320,9")	10150 (399,6")	11550 (454,7")	5000 (196,9")	2980 (117,3")
<b>/19</b>	--	8150 (320,9")	10150 (399,6")	11550 (454,7")	5500 (216,5")	2980 (117,3")
<b>/29***</b>	--	--	--	13050 (513,8")	7250 (285,4")	2980 (117,3")
<b>P-500 double spindle</b>	7450 (293,3")	8150 (320,9")	10150 (399,6")	11550 (454,7")	5650 (222,4")	2980 (117,3")
<b>/12</b>						
<b>/15</b>	7450 (293,3")	8150 (320,9")	10150 (399,6")	11550 (454,7")	5900 (232,3")	2980 (117,3")
<b>/19</b>	--	8150 (320,9")	10150 (399,6")	11550 (454,7")	6400 (252,0")	2980 (117,3")
<b>E-500</b>	7450 (293,3")	8150 (320,9")	10150 (399,6")	11550 (454,7")	5450 (214,6")	2980 (117,3")
<b>/12</b>						
<b>/15/</b>	7450 (293,3")	8150 (320,9")	10150 (399,6")	11550 (454,7")	5950 (234,3")	2980 (117,3")
<b>/19</b>	--	8150 (320,9")	10150 (399,6")	11550 (454,7")	6200 (244,1")	2980 (117,3")
<b>P-600</b>	7800 (307,1")	8500 (334,6")	10500 (413,4")	11900 (468,5")	4500 (177,2")	3400 (133,8")
<b>/12</b>						3700 (145,7")
<b>/15</b>	7800 (307,1")	8500 (334,6")	10500 (413,4")	11900 (468,5")	4750 (187,0")	3400 (133,8")
<b>/19</b>	--	8500 (334,6")	10500 (413,4")	11900 (468,5")	5250 (206,7")	3700 (145,7")
						3400 (133,8")
						3700 (145,7")

\* Dimension with central division. Size of alternating field adjusted to the component size

\*\* Dependent on the machine configuration

\*\*\* Available lengths, table and gantry configurations on request

Technical data and photographs are not binding in every detail. We reserve the right to make changes in the course of further development.

## **HOMAG Group AG**

info@homag.com

www.homag.com



## **YOUR SOLUTION**