

## Edge banding machines KAL 300 profiLine

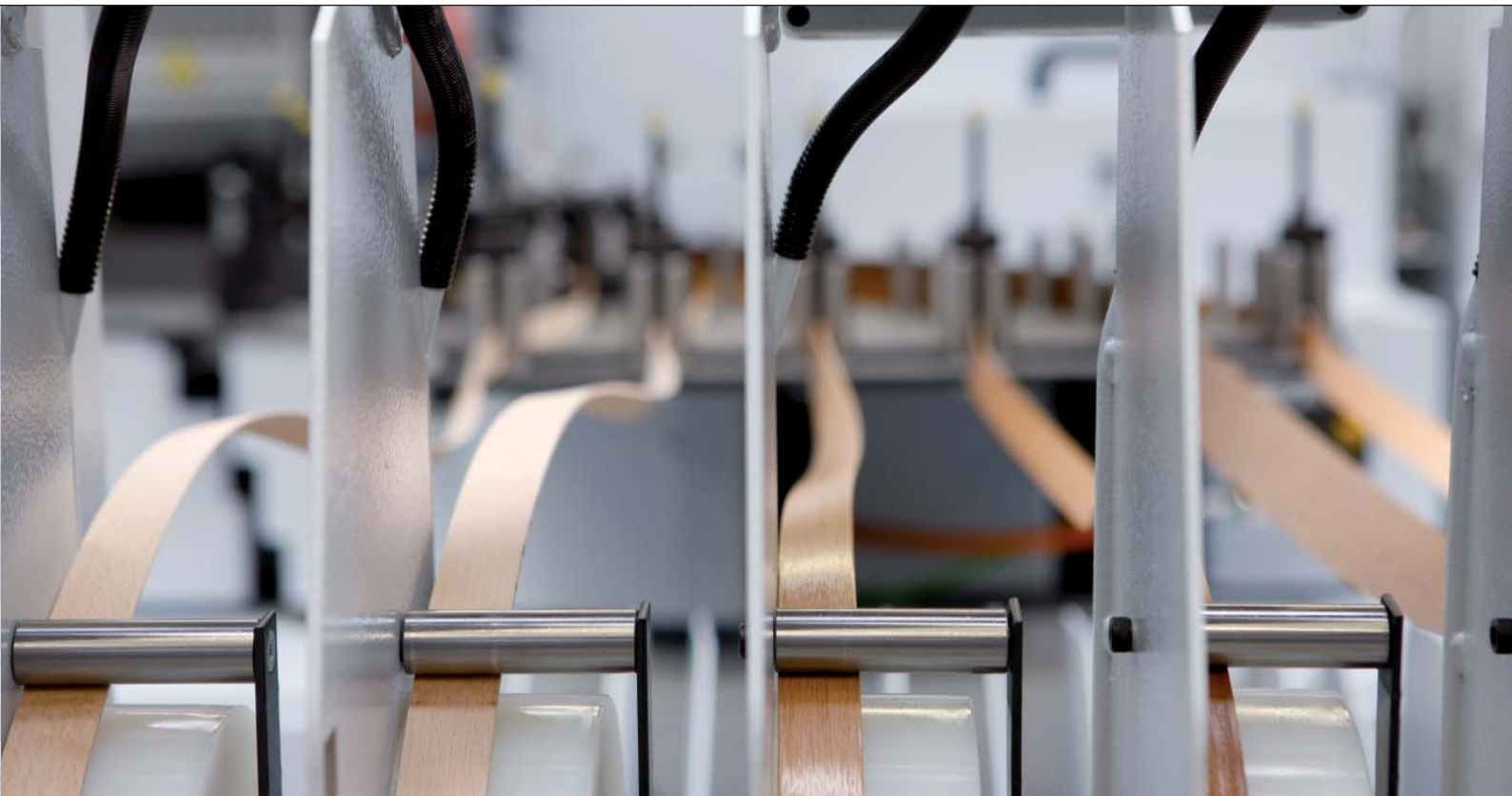

# The range KAL 300: Outstanding both performance and design

HOMAG, a pioneer in the field of sizing and edge processing and inventor of the hot-cold technique has set a whole new standard with these series: Thanks to innovative engineering and durable quality, new landmark achievements are now possible in the field of edge banding in terms of both economy and performance – no matter what the material. Just as impressive: The cost-to-performance ratio and multiple award-winning industrial design which ideally combines ergonomic styling with functionality.



**powerControl system PC22:**  
For efficient operation and simple  
machine programming.

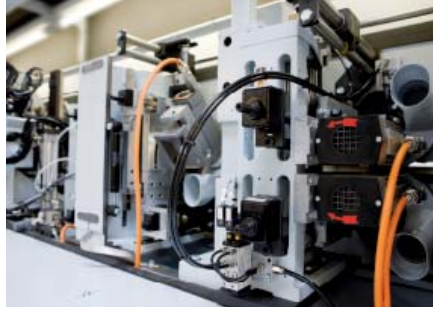

KAL 300 –  
nothing can beat the original.



# Optimum results and reduced piece costs – no matter what the edging material

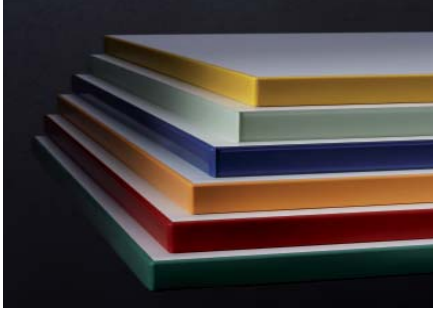

## KAL 300 – An all-round top performer

The development of this series provides an innovative answer to the ever tougher competitive situation in the furniture industry. Producers in this field are confronted in this day and age with growing material diversity. Given the rising cost pressures, every investment has to be planned with meticulous care. Any edge banding machine used in today's toughly competitive environment should be both efficient and capable of material-independent application. The modular HOMAG range delivers a shining performance no matter what the discipline – technology, quality, output, function and design – making for a fast payback of your investment in practical

application.

## A needs-based solution every time: The modular unit range

The range offers a choice of two different models:

- KAL 310, for use as a universal machine also for applications involving PU or with solid mouldings
- KAL 330, suitable for output rates of over 25 m/min. and for flexible production with workpiece feed or gluing of aluminium edges

A comprehensive modular-structured range of units is also available. Individual customers simply select the equipment outfit which ideally suits their specific requirement.

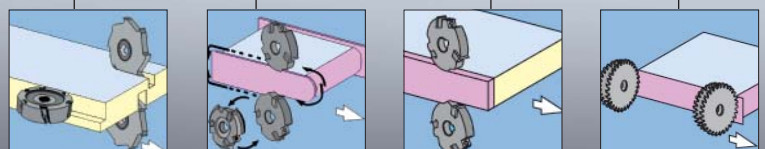
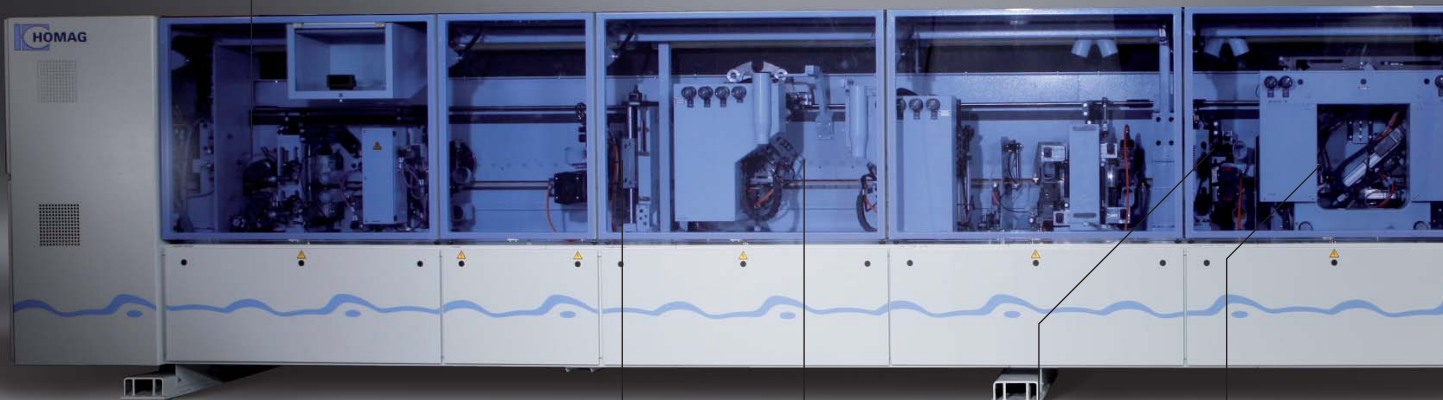
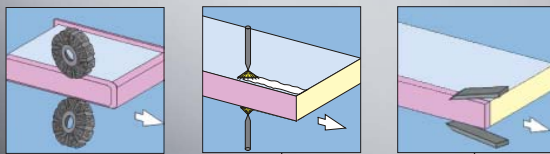

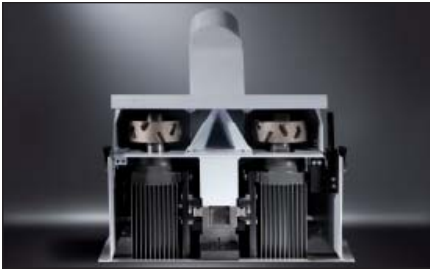

### Jointing trimming unit

This can be used for the precise, splinter-free trimming of every type of workpiece edge. Above-average service life through optimum chip disposal.

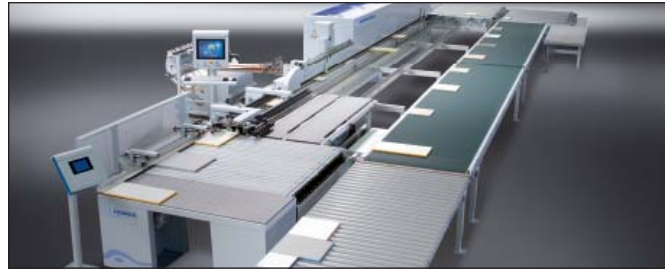

### flexLine processing concept – the entrance in Batch Size 1

Innovative technology permits the flexible processing of panel-shaped workpieces cut to precise dimensions and angles in different measurements on a single-sided edge banding machine. The benefits: Manufacture of up to 500 workpieces per shift, just-in-time production, enormous savings in terms of storage space and almost half the throughput times.

Components used for flexLine production:

- KAL 330 (or comparable machine)
- Automatic workpiece feed
- Air cushion table
- Roller conveyer
- Return conveyer
- Cell control (PC22 and Quick Touch)

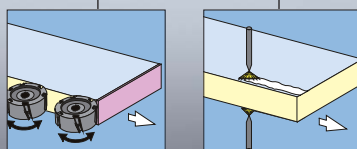
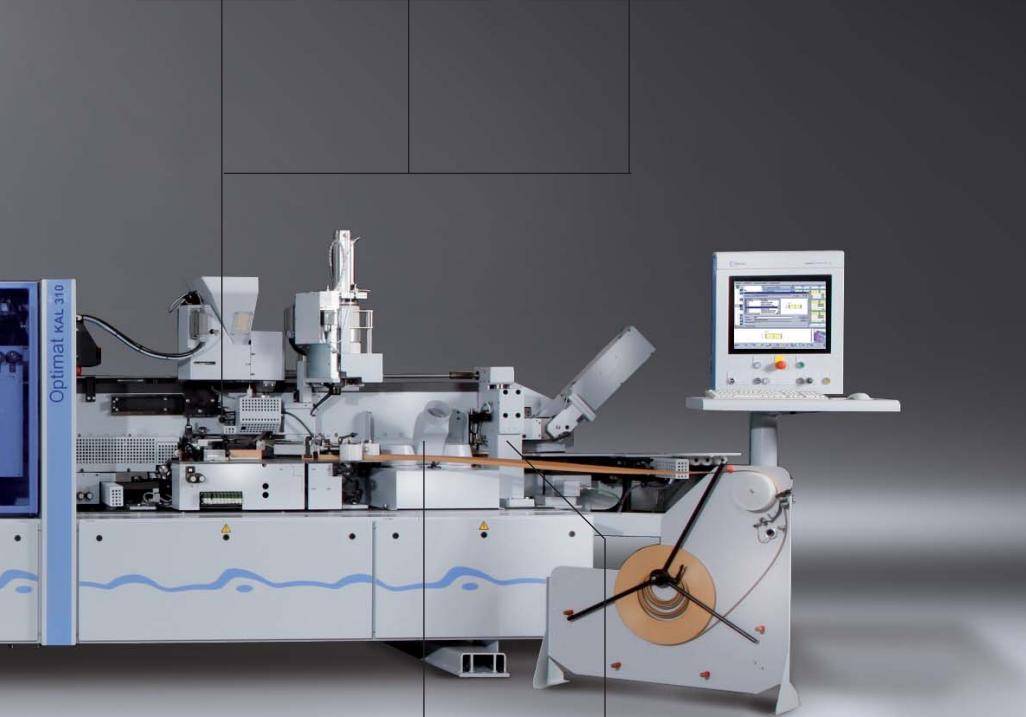
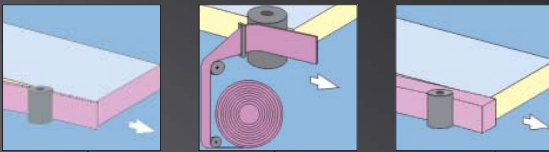

### Your benefits at a glance:

- Durable design
- Processing of all kinds of materials
- Optimum edge quality
- Enhanced availability through maintenance-friendly machine structure
- Greater economy due to minimized extraction output
- Low energy requirement
- Ergonomic operating functions
- Optimum cost-to-performance ratio
- High degree of flexibility in the choice of equipment outfit

# With or without jointing trimming: Two basic models for precise edges

The KAL 300 range encompasses two different basic models. The KAL 310 as the universal machine for every conceivable application, and the KAL 330, which is ideally suited for feed rates in excess of 25 m/min. and workpiece infeed. Both models feature a free space for jointing trimming. This free space can be used to accommodate a jointing trimming tool mounted either immediately on delivery or at a later date. Two gluing section variants are available: A3 for edges up to 3 mm and A20 for coil material edges up to 3 mm and fixed length material of 20 mm.





0.4 mm melamine



2 mm PVC



20 mm solid moulding



Veneer



**The most important features of the basic models:**

**Optimum edge quality**

Edge banding takes place with a wafer-thin glue joint, eliminating the need for finish processing. The quick melt system makes for energy-saving machine operation with minimum heating-up time, and also ensures positive locking of the glue joint. The PU 34 glue system can optionally be used for high-resistance, waterproof and heatproof gluing results on a polyurethane basis.

**Modern design and future-oriented technology**

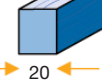
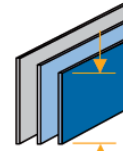
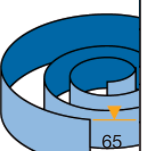
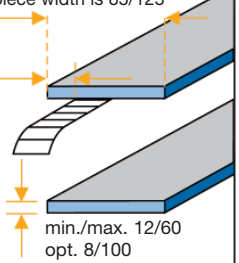
Machine operation is both energy saving and environmentally friendly. The machine is equipped with a PC control system without limit switches. The drive system benefits from low-noise, maintenance-free frequency converter technology, and the motors are braked by an automatic safety system if required.

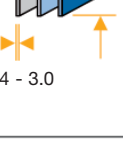
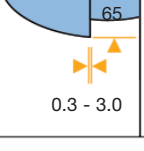
| Machine model | Edging material   |  |   | Workpiece size   |
|---------------|---|--|---|--|
|               | Solid wood  | Fixed length material  | Coils   |  |
| KAL 310       |  |  |  | With a workpiece thickness of 22/60, the minimum workpiece width is 85/125<br><br>min./max. 12/60<br>opt. 8/100 |
| KAL 330       |  |  |  |  |

Dimensions in mm

**Environmentally friendly technology no matter what the material**

The KAL 300 is capable of processing any kind of edging material customarily used by the processing industry today. These include for instance solid wood, coil and fixed length material, melamine, PVC, ABS, aluminium, acrylic and veneer edges. Banding is performed primarily using hot-melt glue, or for special requirements also water-resistant PU adhesive.

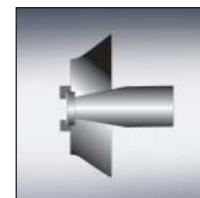
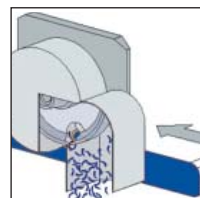
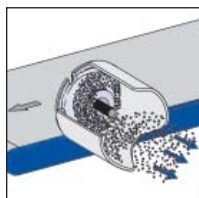
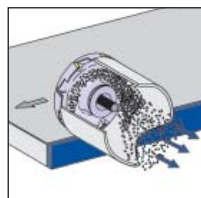

**Finish processing tooling technology for a longer machine life**

The I-System from HOMAG is a revolutionary technological development for controlled chip capture. In contrast to the uncontrolled flying chips created by conventional tools, I-tools ensure the tidy and efficient internal extraction of chips, which can then be guided directly to the dust hood. This eliminates the problem of chips

being scattered during trimming or jointing operations which can adhere in some cases to the workpiece surface. This innovative technological development effectively prevents excessive machine wear and rising service costs. The economy and durability of the machine are enhanced and at the same time the costs of chip disposal reduced due to the lower extraction speed.

The hollow shaft taper (HSK) tool

interface ensures a positive locking connection between the tool and motor shaft, resulting in zero tolerances between the motor shaft and tool. This results in outstanding trimming quality due to optimum tool concentricity and freedom from vibrations.

# The HOMAG standard: Optional machine equipment for made-to-measure results

The KAL 300 models were designed to operate as typical throughfeed machines. This means that each workpiece is processed from start to finish without the need for any additional processing steps. To ensure that customers are offered the ideal solution to fit their individual processing needs every time, our engineering staff have developed a wide range of suitable processing units and additional options. With this machine range, HOMAG customers are offered the scope to configure their own equipment outfit, from the first work step to the perfect finish.

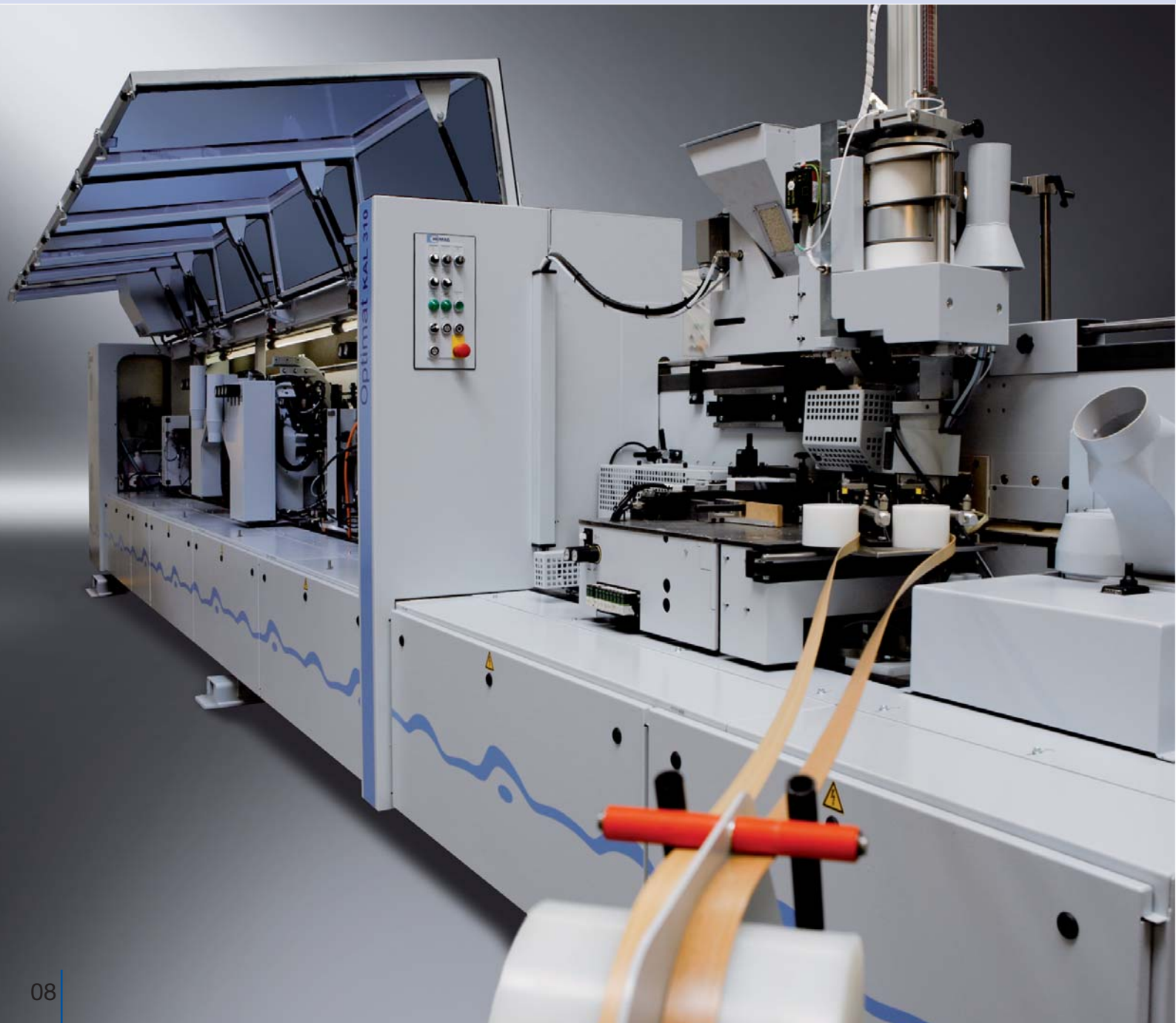



# Separating agent, jointing

So that every production step can be effectively carried out with top class results, the components used by HOMAG are designed to interact like cogs in a gearing system.

Example: The units used for workpiece preparation provide the basis for perfect glue joints.

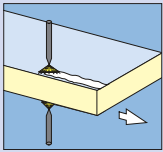

## Separating agent spraying unit

Prevents adhesion of glue residues on the top and bottom surface of workpieces. Benefit: No need for manual finishing steps. (in conjunction with the glue joint scraping unit)

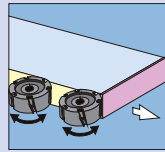

## Jointing trimming

This unit permits optimum processing precision, is extremely hardwearing and capable of achieving an above-average service life. The tool diameter is 125 mm.

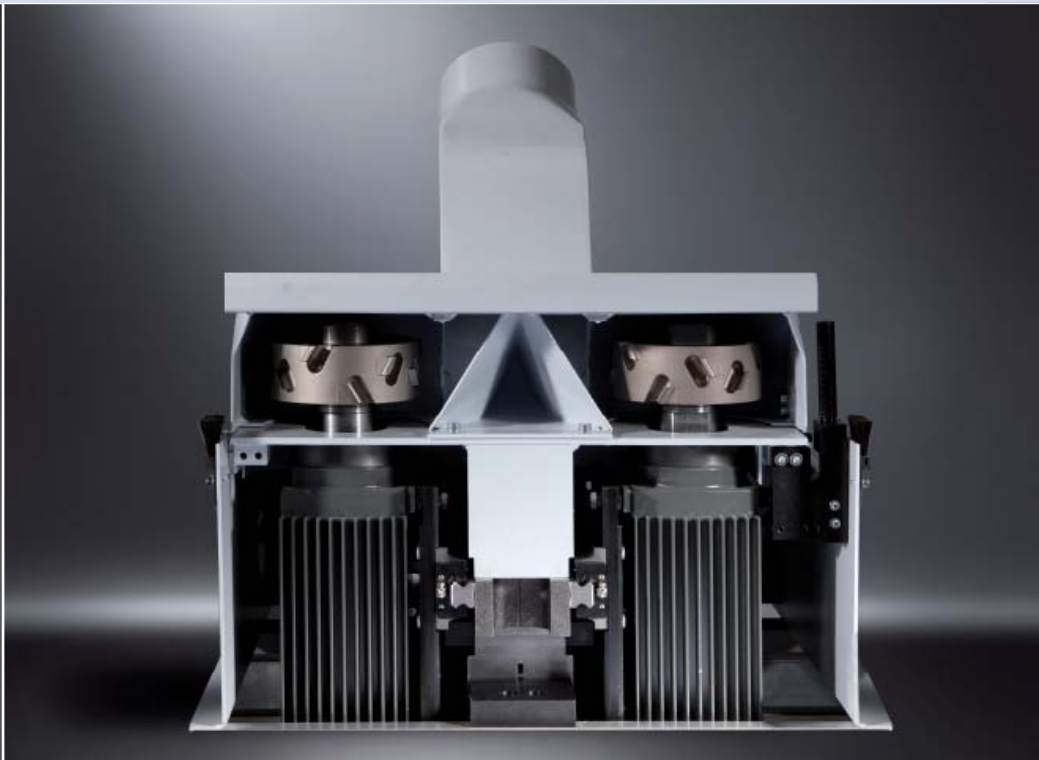

## Automation to suit every need

- Automatic height adjustment
- Program-driven trimming tool centering

# Gluing units

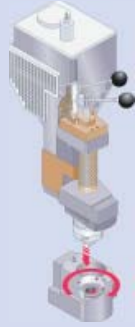

These units provide all the functions needed for fast, friction locking adhesion. A pre-melting unit is included as a standard feature. A heated glue roller takes care of the optimum glue temperature, while magazine height adjustment offers scope for processing wide-ranging different workpiece widths. If a different production step has to be performed, the application unit can be simply and quickly exchanged without using tools.

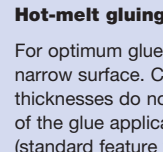
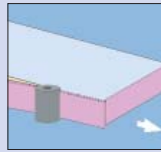
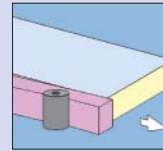
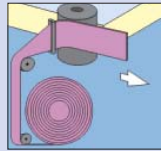

## Hot-melt gluing unit A3

For optimum glue application on the narrow surface. Changes to workpiece thicknesses do not necessitate resetting of the glue application roller (standard feature in the KAL 300/A3).

## Hot-melt gluing unit A20

For optimum glue application on the narrow surface. Changes to workpiece thicknesses do not necessitate resetting of the glue application roller (standard feature with the KAL 300/A20).

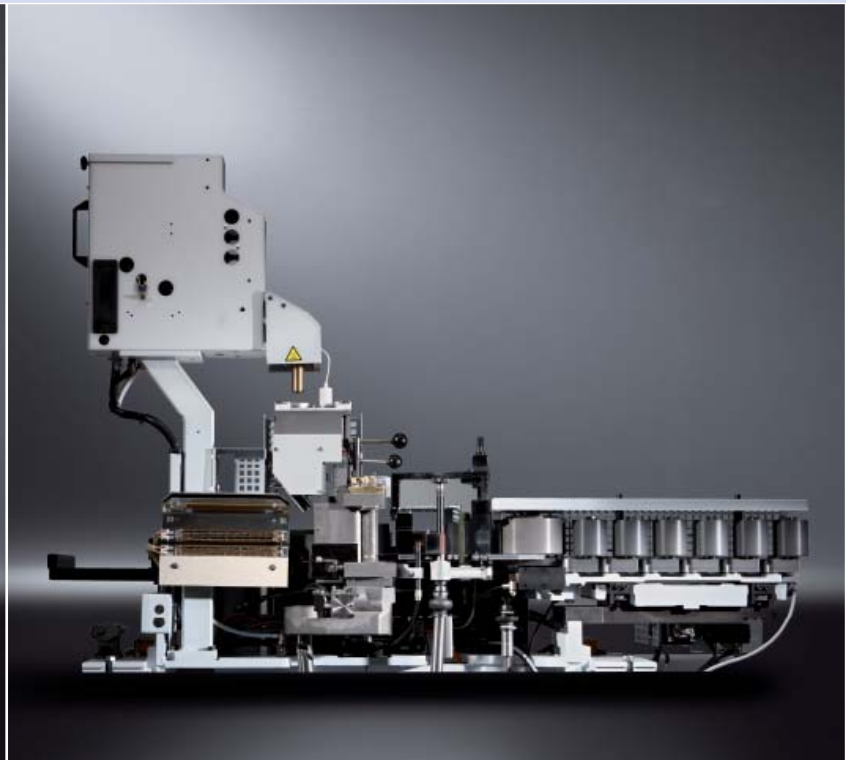
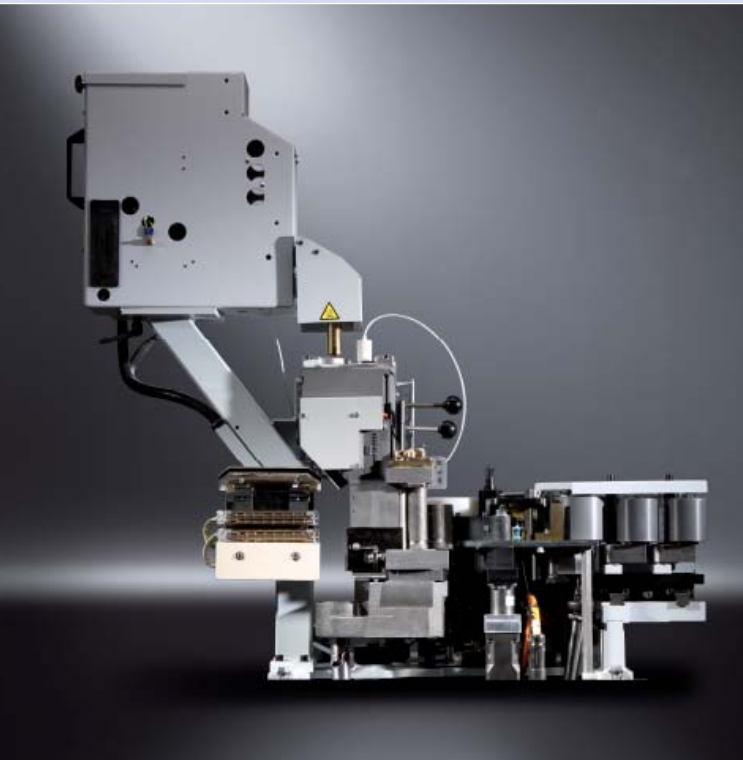
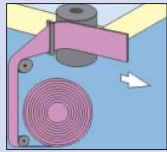

## Automation to suit every need

- Optional pre-melting function
- Edge holding-down device with automatic stepless adjustment
- Automatic adjustment of the pressure zone to the edge thickness
- Edging magazine: 2, 6, 12 to 24 slots

## Pre-melting unit with higher performance optionally available

### Melting unit with granulate tank

With a melting rate of 18-35 kg/h there is always plenty of freshly prepared hot-melt glue available.

### PU melting unit

For melting 2 kg drums of PU adhesive (only with the A20).

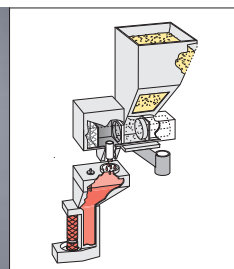

# Snipping units

These HOMAG units prepare the workpiece with a perfect cut surface for further processing.

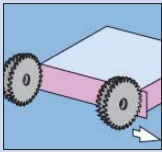

## Snipping unit HL81

For snipping the edge overhang at the leading and trailing workpiece edge. Low-cost snipping unit with drawing cut.

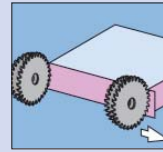

## Snipping unit HL84

For snipping the edge overhang at the leading and trailing workpiece edge with stationary snipping stop to protect sensitive workpieces from damage. Drawing snipping cut for optimum snipping saw cutting quality.

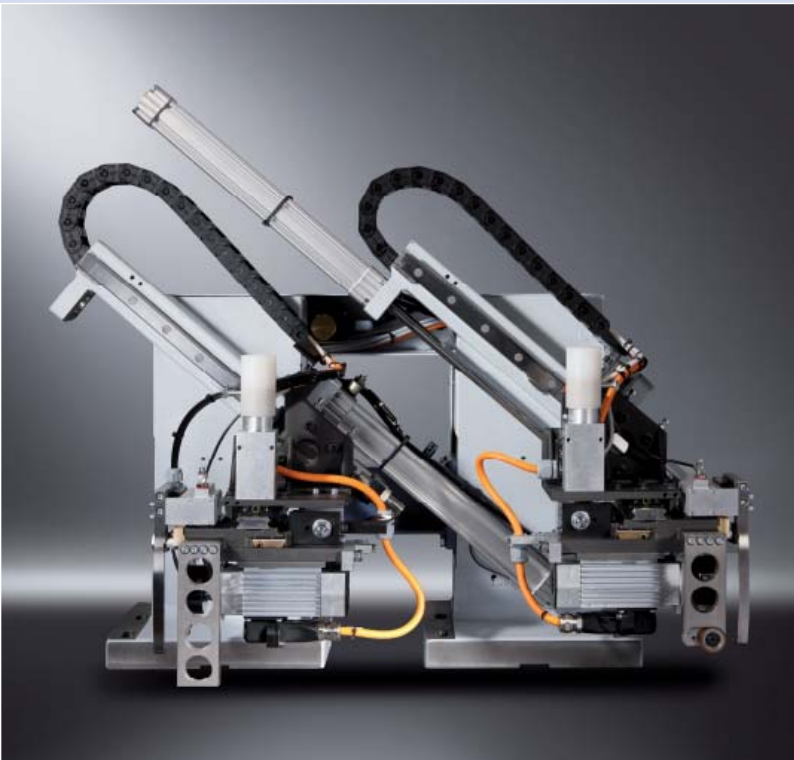

## Automation to suit every need

Programmable chamfer/straight adjustment of the snipping motor.



For fast changeover between flush snipping (e. g. of solid mouldings or inlay shelves) and snipping with overhang (e. g. for finish trimming with profile trimming unit).



# Longitudinal flush trimming unit

The task of HOMAG trimming units is to transform the workpiece edges to create the required finish shape. Even the basic units provide practically-oriented solutions for the most important trimming requirements.

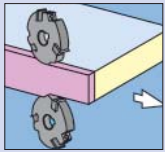

## Rough trimming unit

For rough trimming the upper and lower edge overhang.

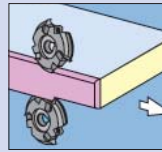

## Trimming unit

For trimming chamfers or radii.



## Automation to suit every need

### Rough trimming unit

For automatic changeover from flush trimming to trimming with edge overhang.

Solid mouldings



PVC



### Multi-trimming unit MF21

For automatic changeover between different profiles, e.g. chamfer 20°, R2 and R3.



# Profile trimming

Profile trimming units from HOMAG master the art of trimming to the very highest level. All the required trimming functions are programmed by the user and executed at high speed to an outstanding degree of precision, providing the optimum basis for operational efficiency, leading to higher productivity.

The dual-motor profile trimming units permit both corner rounding and trimming the upper and lower edge overhang.

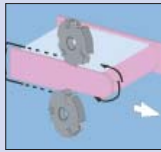

## Profile trimming unit FK11

For processing overhanging edges. Also for trimming around the leading and trailing edge.

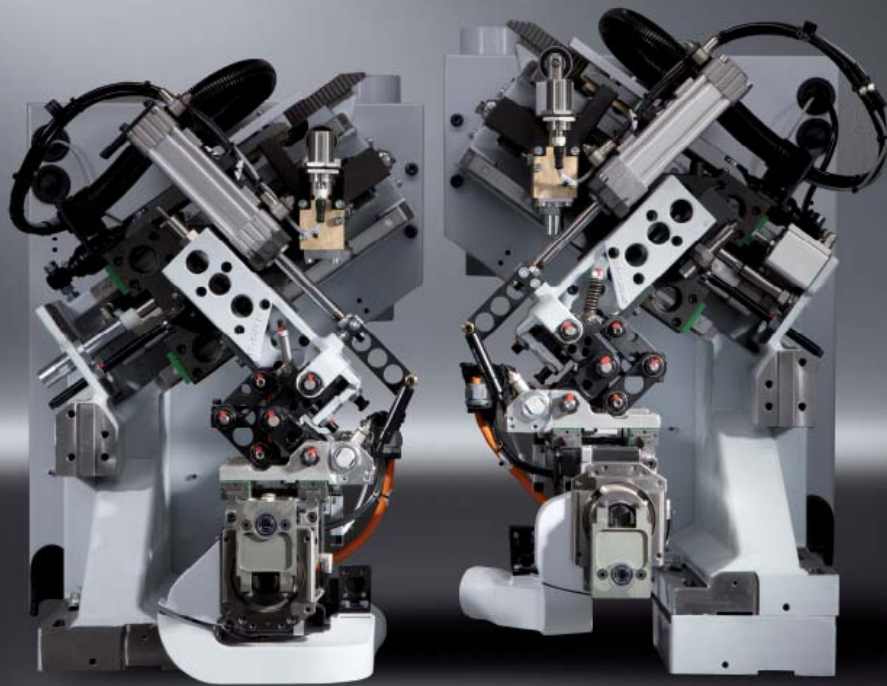

## Automation to suit every need

Chamfer/radius adjustment for fast changeover between for instance 0.4 mm and 2 mm edges.

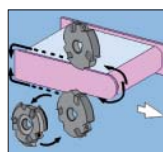

## Profile trimming unit FK13

For processing overhanging edges and trimming around the leading and trailing edge. With 8-slot tool changer.



# Profile trimming

The four-motor profile trimming unit takes care of corner rounding when processing veneers. Flush trimming is optionally also possible at the top and bottom workpiece surface.

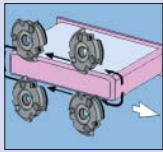

## Profile trimming FF12

For rounding edges above and below at the leading and trailing workpiece edge.

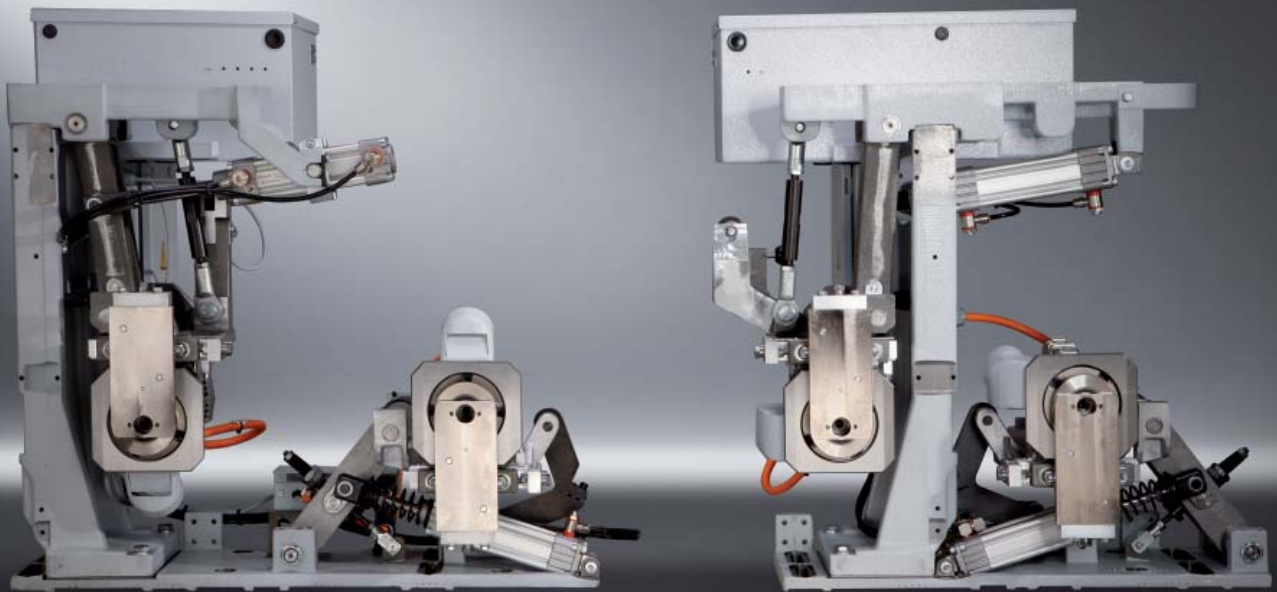

## Automation to suit every need

Chamfer/radius adjustment for fast changeover from for instance 0.4 mm to 2 mm edges.

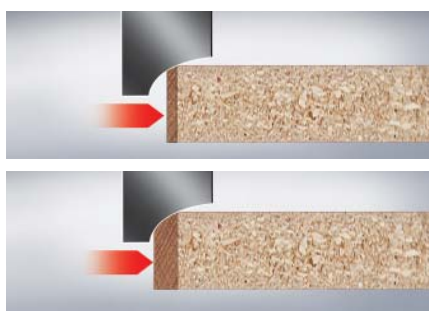

# Universal trimming

Allows grooving with any optional cut-in and cut-out points during trimming operations without the need for an additional pass.

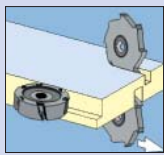

## Universal trimming unit UF11

For grooving, rebate trimming and profiling.

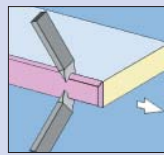

## Profile scraping unit PN20

For smoothing trimmed edges to achieve an optimum appearance.

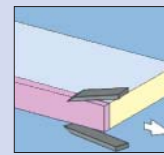

## Finish processing unit FA10

Comprising a glue joint scraping unit for disposal of glue residues at the top and bottom of PVC edges.



# Automation to suit every need

- Axes for program-driven horizontal and vertical adjustment
- Workpiece tracing from above or from the side for precise edge profiling

## Multi scraping device MN21

Changeover between different profiles, e.g. chamfer 20°, R2 and R3.



# Finish processing

HOMAG supplies units to meet the most stringent quality standards for the assembly-ready production of panels, with cleaned and automatically finish processed edges.

This is where premium quality is produced straight off the production line.

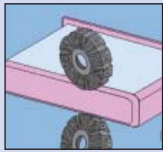
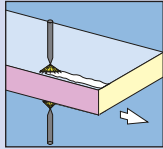
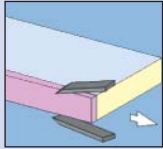

## Finish processing unit FA11

Comprising a glue joint scraping unit, cleaning agent application and buffing for disposal of glue residues on PVC edges.

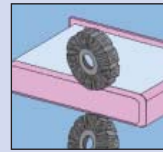

## Buffing unit top and bottom with oscillation

For smoothing off edges using the entire disc width.



## Automation to suit every need

- Automatic move-in and move-out from the work area



# Finish belt sanding

Sanding units from HOMAG impart the perfect finishing touch to straight or profiled veneered edges. Naturally with facility for general sanding pressure adjustment.

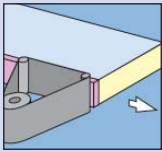

## Belt sanding unit KS10

For sanding straight veneered and solid edges including oscillation as a standard feature.

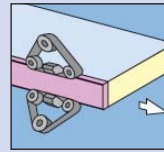

## Chamfer/radius sanding unit PS41/PS42

For sanding chamfers and radii at the top and bottom of veneered and solid wood edges.

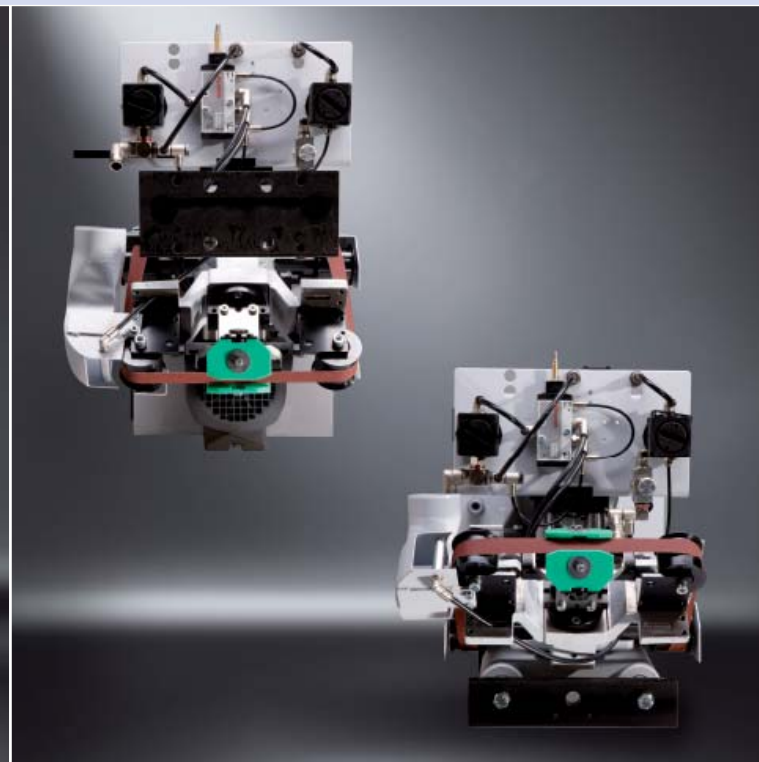
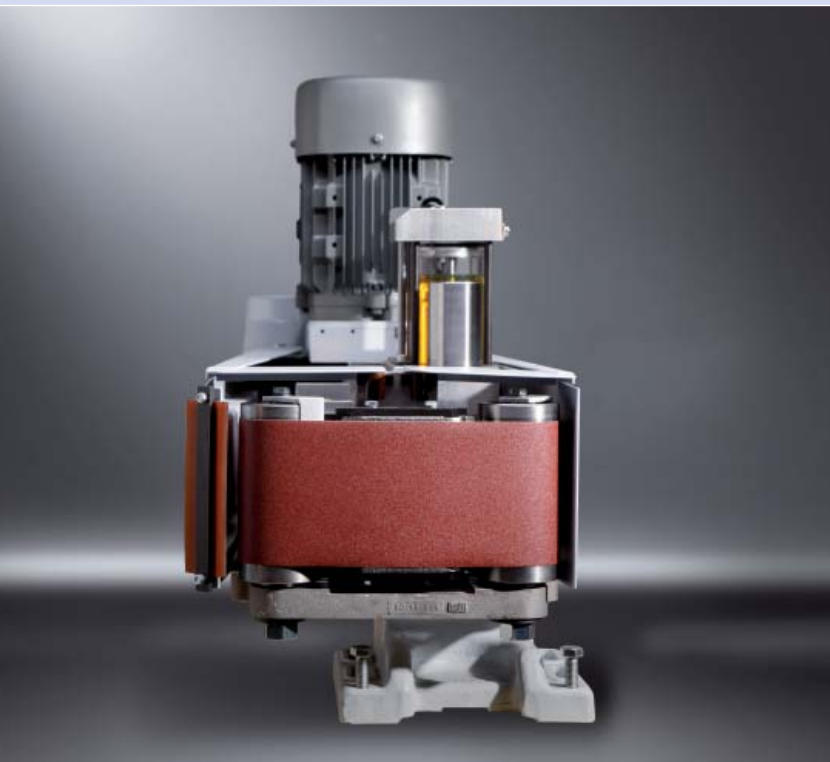

## Automation to suit every need

- For moving out of the work area
- For stepless adjustment to different edge thicknesses and moving out of the work area

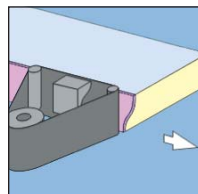

## PS10

For profile sanding

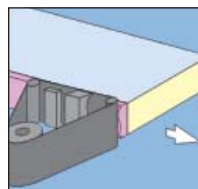

## PS20

For profile sanding using dual pad technology with two separately adjustable sanding pads

# Operation and control – ergonomics hand in hand with efficiency

To allow the full performance potential of your machine to be utilized, simple operation and reliable control are highly important issues – particularly for smaller outfits. In the KAL 300 machine series, manual intervention in the machine's operation is cut to a minimum with a control system solution tailored to the user's needs. Above and beyond the standard package, a wide choice of options is available to extend the functional scope and operating convenience of the machine as well as enhancing productivity.

## Standard



### powerControl Control system PC22

This modern, highly flexible control system offers a range of additional functions for the simple, reliable operation of your machine:

- User-friendly menu prompting using the Windows-XP standard
- Large 17" display affords a clear overview of all machine functions
- Easily understandable plain text messages in the local language

These benefits combine to ensure a production-ready machine as and when you need it.

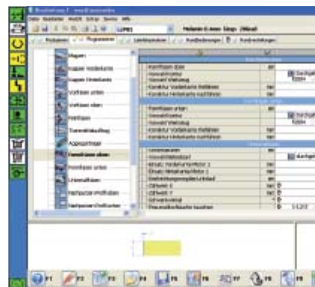

### woodCommander

The programming system for all the HOMAG through-feed machines. Extreme user convenience due to graphically supported input masks for simple navigation and menu prompting.



### Schuler MDA basic

The acquisition of piece numbers and actual operational times at the machine provides meaningful information about your machine's productivity. Integrated prompting ensures timely execution of necessary maintenance work in keeping with the maintenance schedule.



### USB port

Data input and data safety using external USB storage facilities ensure simple data handling and provide the assurance of a production-ready machine.



## Options

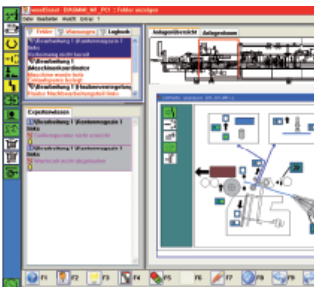

### Diagnostic system woodScout

High-performance diagnostic system which as well as providing plain text messages also offers a graphic indication of the fault location at the machine. The facility for saving remedial actions in the woodScout memory permits the expert knowledge supplied with the diagnostic system to be continuously extended by the customer.

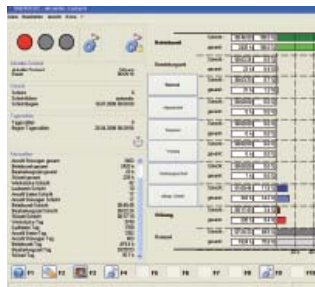

### Schuler MDA professional

By upgrading from Schuler MDE basic, users can obtain a detailed breakdown of actual operational times into production time, set-up time, down time due to faults and down time due to interruptions. The integrated shift management and logging system allows production data to be acquired and evaluated on a user-dependent basis.



### Barcode reading system

This system encompasses a wireless radio scanner and the software for automatic transfer of barcode information, allowing programs to be simply and quickly loaded into the machine.

### Touchscreen operation

The new touchscreen offers an outstanding degree of user convenience coupled with operating simplicity. Just a single "touch" on the large 19" display allows the user to select all the important functions for fast, reliable production: Program selection, selection of edges and changing the workpiece height are just some of the possibilities afforded by this new and innovative operating concept.

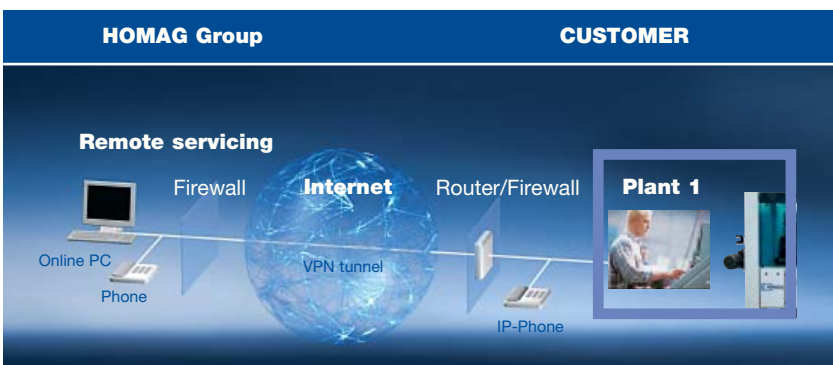

### TeleServiceNet

Selective fault analysis and diagnostics using Internet technology offer scope for rapid service and assistance. With a single connection, all the machines of a production line can be accessed right down to the last link in the control chain.

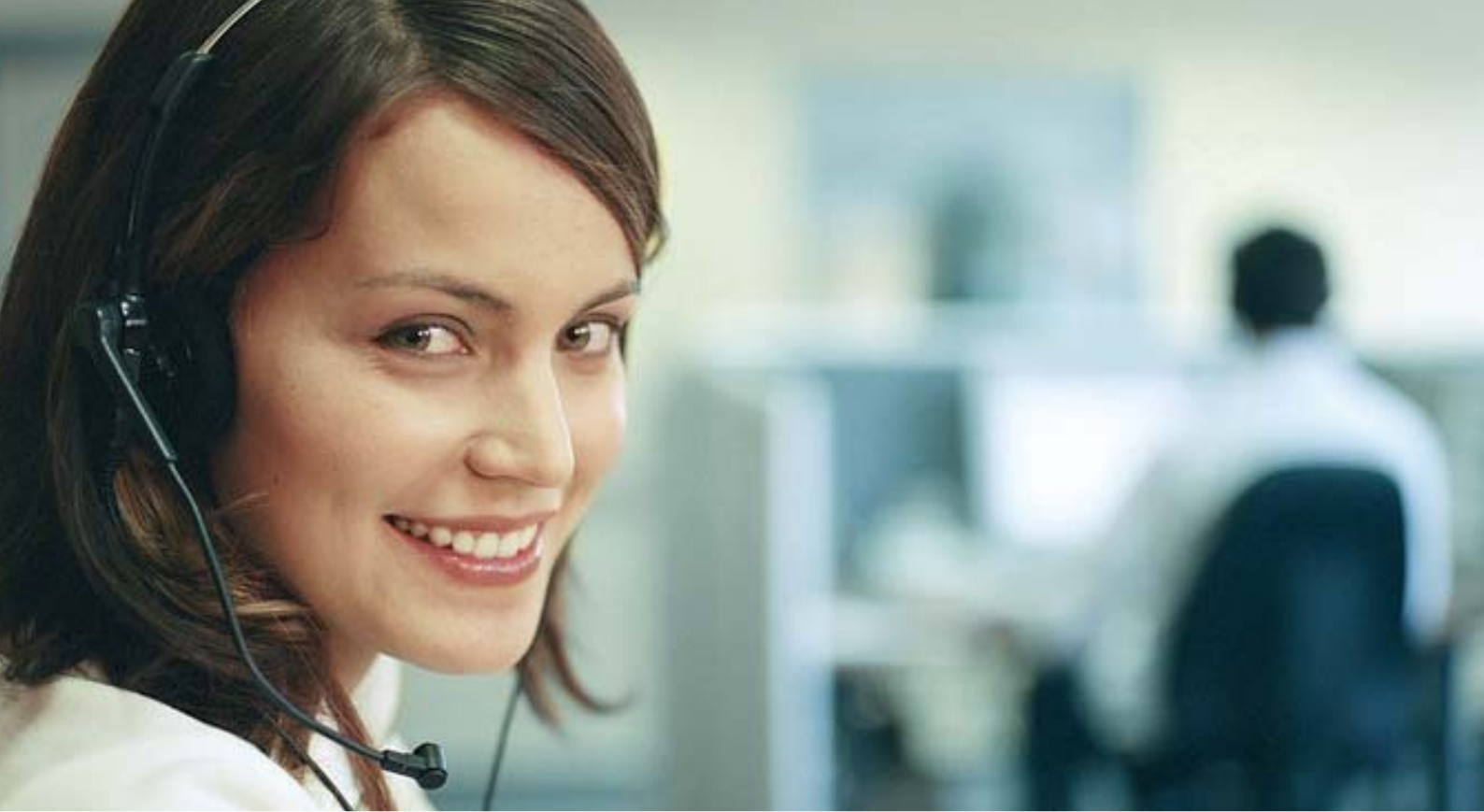

### The HOMAG pledge:

#### Perfect planning

- We provide competent advisory support; right from day one
- You find the best possible, most economical solution

#### Custom-tailored financing

- We offer a range of attractive financing possibilities
- You leave your capital base intact

#### Fast production start-up

- We take care of installation and commissioning
- You can get your production up and running straight away

#### Reliable operation

- We train your staff and bring them up to speed
- You can use your machine's full potential

#### Ongoing support

- We provide in-process support and machine optimization
- You gain from maximum productivity

#### Reliable function

- We offer preventive maintenance by video/remote diagnosis
- You have the assurance of absolute production reliability

#### Efficient support

- We ensure a rapid repair and spare parts service
- You avoid unnecessary production standstill

#### Worldwide presence

- We guarantee the worldwide availability of our services
- You are in capable hands – wherever you need us

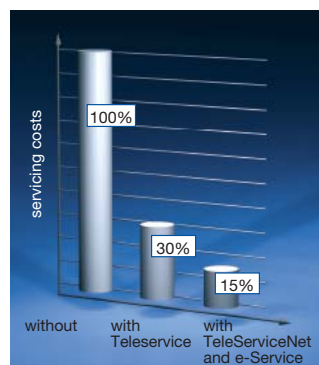

HOMAG TeleServiceNet: Remote diagnosis permits shorter diagnostic times and reduced costs and charges to customers.

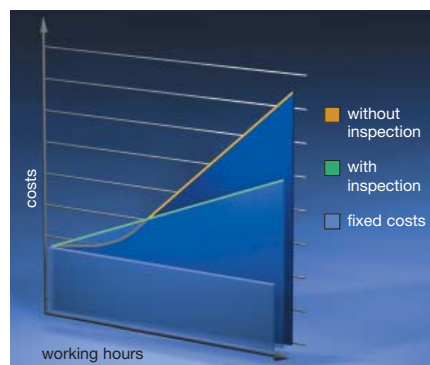

HOMAG inspection helps cut down disruptions and costs

# Something you can count on the world over: the HOMAG Service Package

Purchasing a HOMAG machine is making a wise investment in the future – in rising productivity and a sharper competitive edge – in brief: in a solid foundation for economic success.

We are there right behind every HOMAG customer with the support it takes to realize this goal.

With technological excellence and a comprehensive package of services. From planning and design through installation to running production. This provides the absolute assurance that every machine will meet its expectations. Today and tomorrow. Day in, day out.



**lifeline | service**

HOMAG **lifeline | service** provides the assurance of optimum machine availability and economical production – over the entire life cycle of your machine

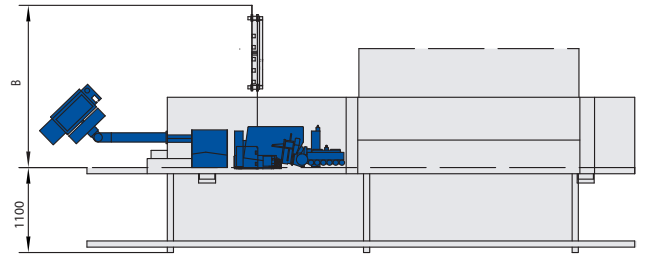
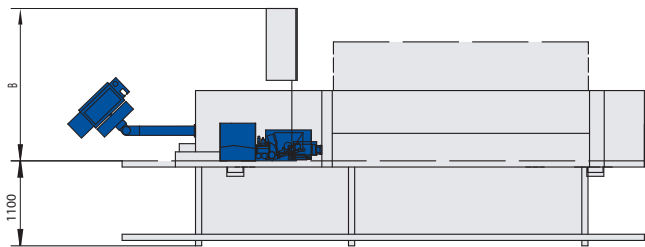
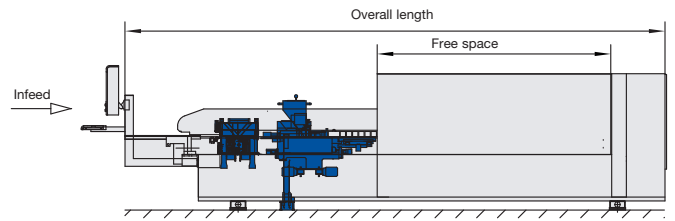
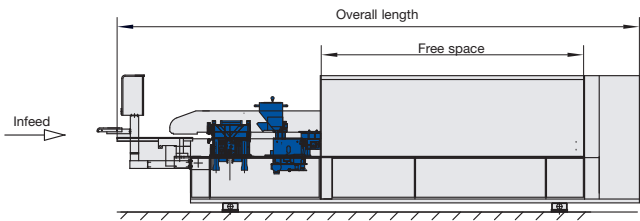
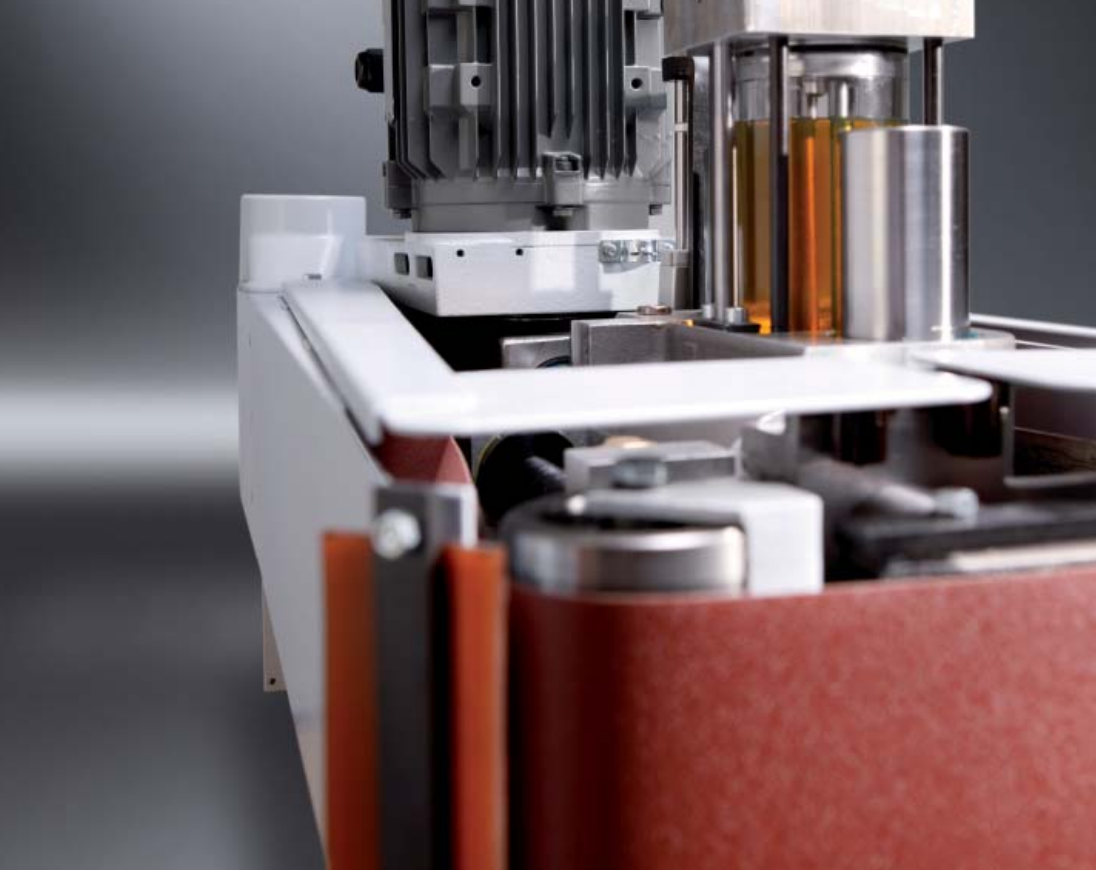

# Technical data KAL 300

The KAL 300 series offers a wide-ranging product spectrum to the very best HOMAG standard of quality at a highly affordable price. This machine model permits precisely positioned edge banding and is available in different overall lengths. It can be integrated into any machine environment. An extensive range of available retrofit units allows users to accept widely varying production assignments.

| KAL 310 and KAL 330 |       |       |       |       |       |       |        |        |        |        |
|---------------------|-------|-------|-------|-------|-------|-------|--------|--------|--------|--------|
| Overall length [mm] | 5,630 | 6,130 | 6,880 | 7,755 | 8,545 | 9,295 | 10,045 | 10,860 | 11,610 | 12,360 |
| Machine model       | 3     | 4     | 5     | 6     | 7     | 8     | 9      | 10     | 11     | 12     |

## Machine dimensions

|                                 |                 |  |
|---------------------------------|-----------------|--|
| Overall length [mm]             | see table above |  |
| Noise protection covers         |                 |  |
| Overall width closed/open [mm]  | 910/1,540       |  |
| Overall height closed/open [mm] | 1,740/2,280     |  |
| Working height [mm]             | 950             |  |

## Working dimensions

|  |      |             |
|--|------|-------------|
| Workpiece width                          |      |             |
| with workpiece thickness 22 mm [mm]      | min. | 55          |
| with workpiece thickness 60 mm [mm]      | min. | 100         |
| Workpiece thickness [mm]                 | min. | 12 opt. 8   |
|  | max. | 60 opt. 100 |
| Edge thickness, fixed lengths/coils [mm] | min. | 0.3         |
| A3 [mm]                                  | max. | 3.0         |
| A20 [mm]                                 | max. | 20.0        |
| Edge length coils A3/A20 [mm]            | min. | 150         |
| Edge length fixed lengths A3/A20 [mm]    | min. | 200         |
| Workpiece overhang fixed [mm]            | 30   |             |
| (optionally adjustable with KAL 330)     |      |             |

## Connected loads

|   |                                     |
|---|-------------------------------------|
| Operating voltage                         | 400 V                               |
| Control voltage                           | 24 V                                |
| Frequency                                 | 50 Hz                               |
| Static converter                          | integrated                          |
| Switch cabinet                            | mounted                             |
| Total electrical connected load kW        | depending on equipment              |
| Total extraction output m <sup>3</sup> /h | depending on equipment              |
| Air velocity                              | 28 m/sec.                           |
| Compressed air consumption                | depending on equipment              |
| Compressed air port                       | R1/2" Female thread supply line R1" |
| Pressure loss                             | appr. 200 mm/WG                     |

## Miscellaneous

|                                 |                            |
|---------------------------------|----------------------------|
| Feed rate, fixed                | 18 m/min.                  |
| Optional: Steplessly adjustable | 18 - 25 m/min. (32 m/min.) |
| Machine speed appr. kg          | depending on machine type  |

Photos and technical data are not binding in every detail.  
We expressly reserve the right to make changes in the interests of further development.



A member of the HOMAG Group



**HOMAG Holzbearbeitungssysteme AG**

Homagstraße 3-5

72296 SCHOPFLOCH

GERMANY

Phone +49 7443 13-0

Fax +49 7443 13 2300

info@homag.de

www.homag.com