

Software from the HOMAG Group for machining centers

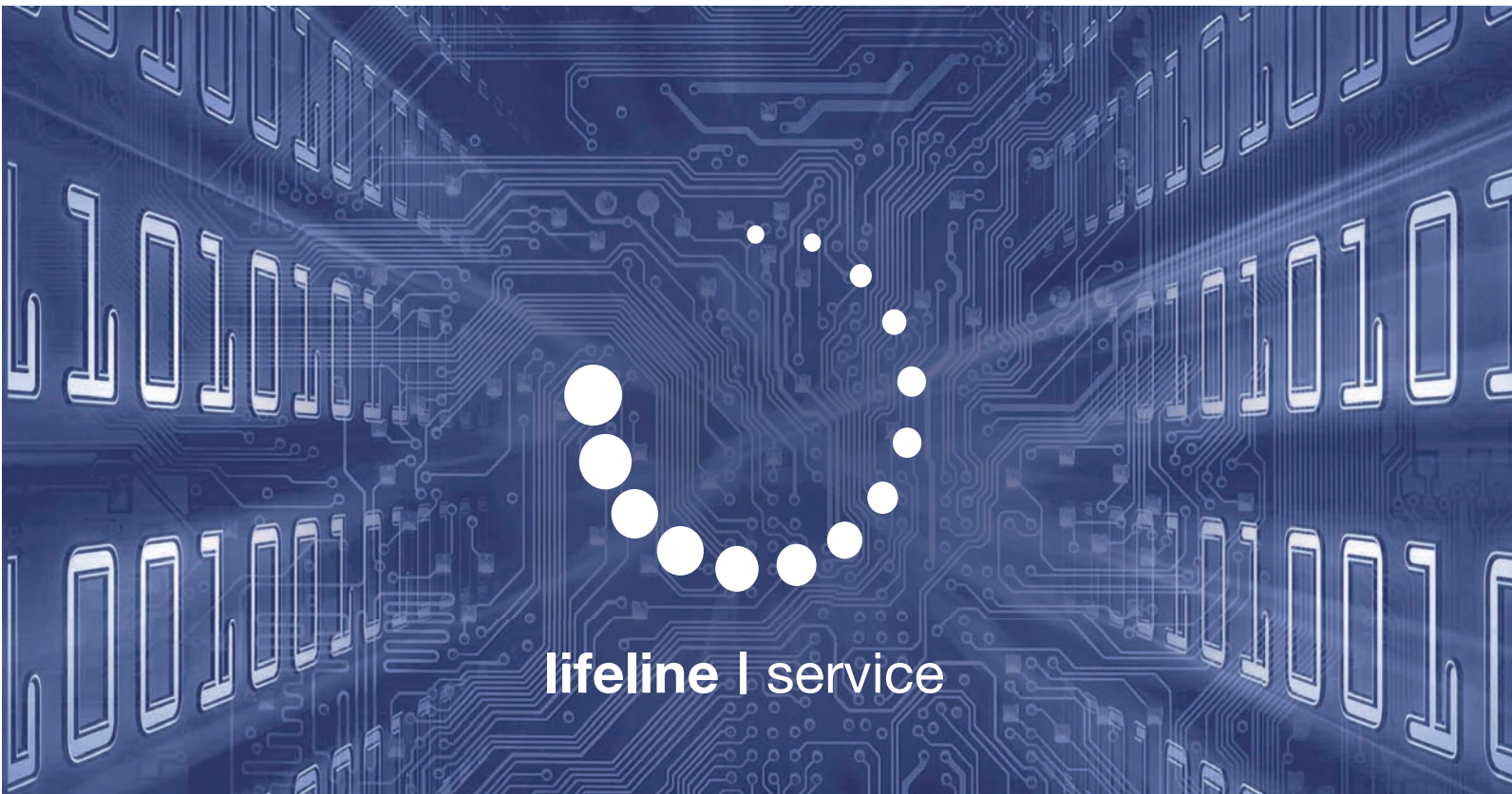

lifeline | service

On the Road to Success with Software from the HOMAG Group!

Our extensive range of software, the knowledge of how to implement it and guaranteed compatibility with our machines ensure that you have maximum flexibility while at the same time enjoying excellent operating reliability. Our experienced team of software experts is standing by with a software package that meets all your requirements for integrating the machine into your business. Our stated aim is to offer you all the support you need to achieve success. Take advantage of our range of software modules, which are perfectly integrated into the machine environment.

Content

License Server	3
woodWOP	4
woodWOP DXF-Import Basic + Professional	6
woodWOP MPR interface	7
woodDesign	8
woodAssembler	9
Nesting Solutions	10
Simulation and Time Calculation	12
Projectmanager	14
Window Software	15
powerControl	16

Advantages include:

- Complete solutions for integrating the machine into the production process
- Investment security thanks to downwardly compatible development
- Coordinated modules
- Modern software architecture

Choose from a wide range of software modules to find the optimum configuration for your requirements.

A demo version of the different applications can be found at our web site www.woodwop-forum.de under Download > Download a demo version.

Do you have an individual requirement?

We have extensive experience in developing customer-specific software.

License Server

The HOMAG Group software is protected by license server



Single place license

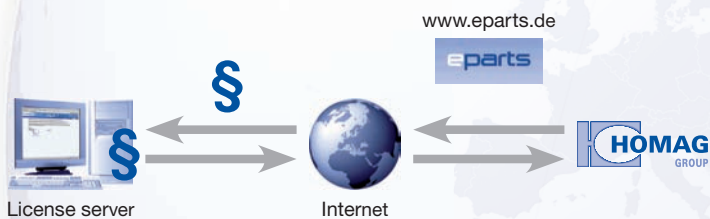

Floating license

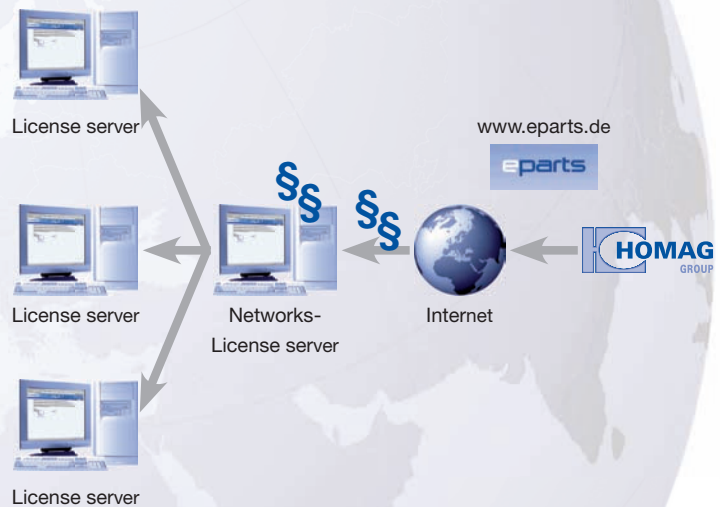

1. Register under www.eparts.de
2. Install and start software.
3. Until receipt of the eparts login data you can use the software in demo mode.
4. Start license server and enter your eparts login data.
5. Request the licenses you would like to obtain.

1. Register under www.eparts.de
2. Install and start software.
3. Until receipt of the eparts login data you can use the software in demo mode.
4. Start license server and enter your eparts login data.
5. Configure the license server for utilization in networks
6. Request the licenses you would like to obtain.

woodWOP

The CNC programming system of the HOMAG Group



woodWOP is the CNC programming system of the HOMAG Group. The large graphics area with a three-dimensional view of the workpiece is the centerpiece of the innovative surface. Routing, drilling or sawing can quickly and easily be programmed by entering the machining parameters and displayed realistically in the graphics area. This guarantees highest programming safety and permanent control during program generation.

Advantages

- Higher programming accuracy due to 3D graphics of workpieces, machining and clamping aids.
- Quick data input through direct navigation.
- Very easy to operate due to the new design of the user interface, e. g. individually adjustable windows, multiscreen ability, language-neutral input masks, help images etc.
- Largest forum on CNC programming in the internet: www.woodWOP-Forum.de
Help and information from woodWOP user to woodWOP user as well as discussion.

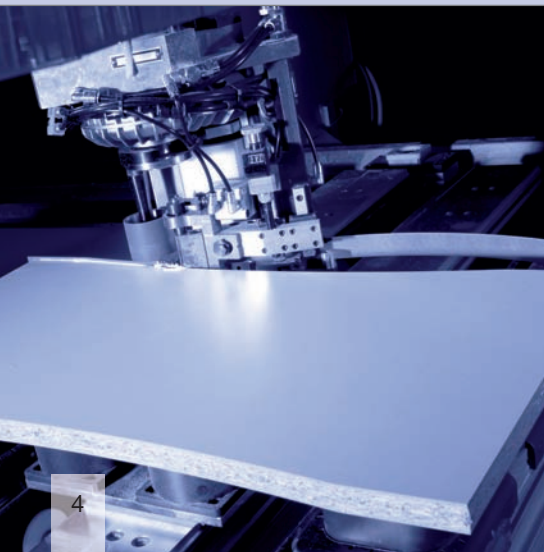
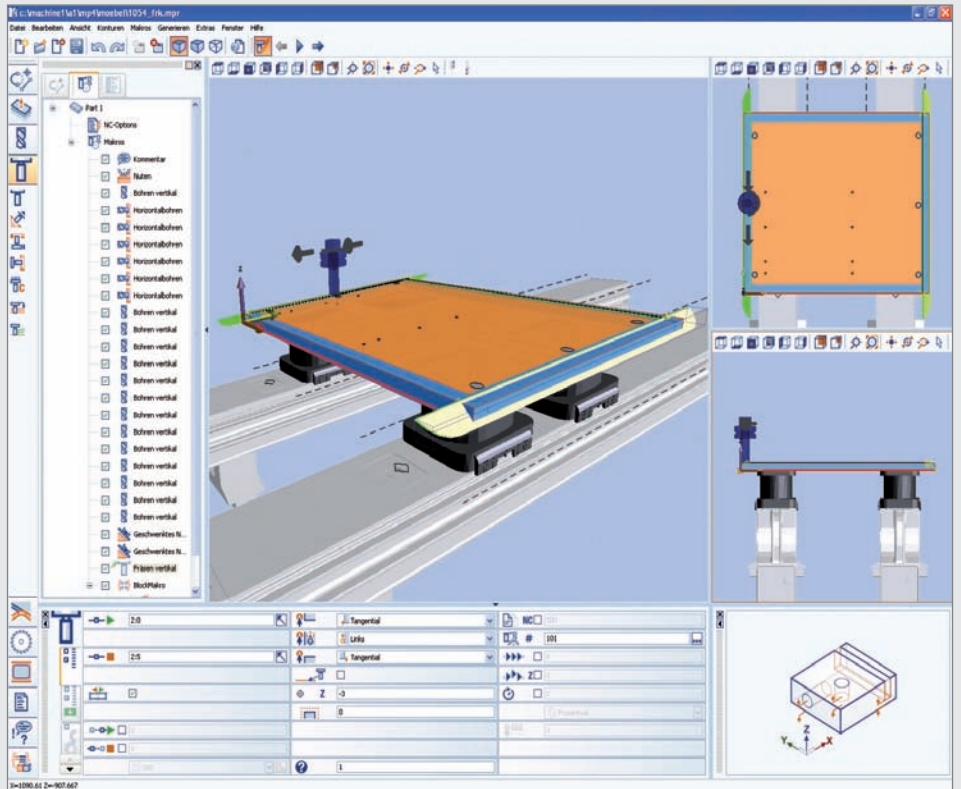

By using the woodWOP Wizard all machining steps for edge banding are generated at the push of a button.

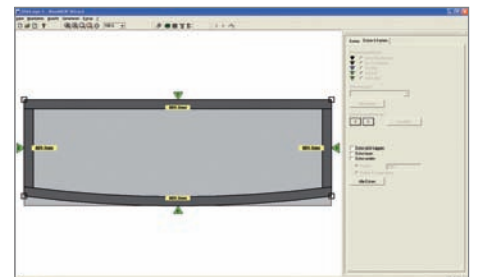

Tool preview and preview of processing tracks provide greater accuracy for the programmer – especially in case of 5-axis programming.

With the integrated program woodType texts and letterings can be converted into routing information quickly and easily. In addition, woodWOP now also includes the application woodWOP Mosaic with which individual woodWOP programs can be administrated and combined.

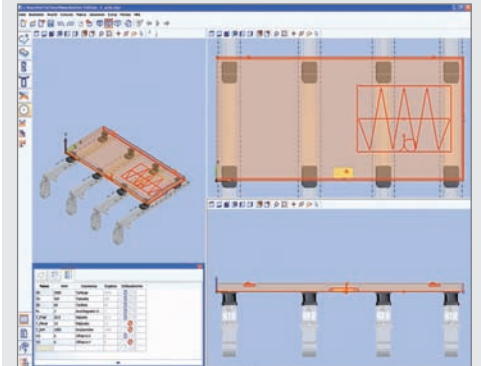
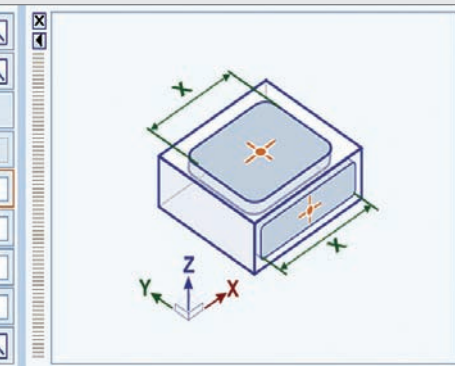
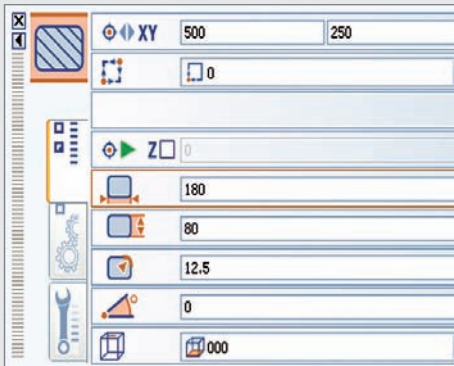
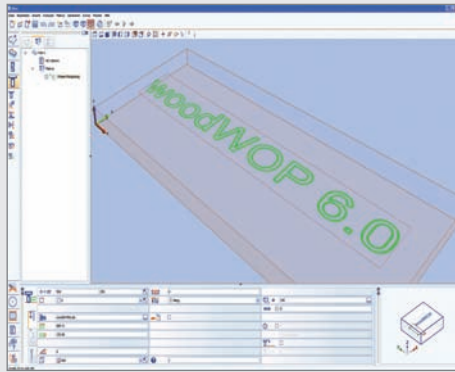
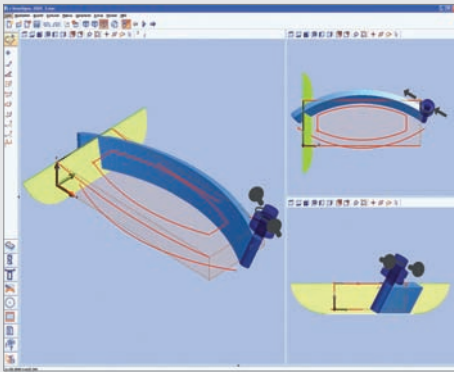
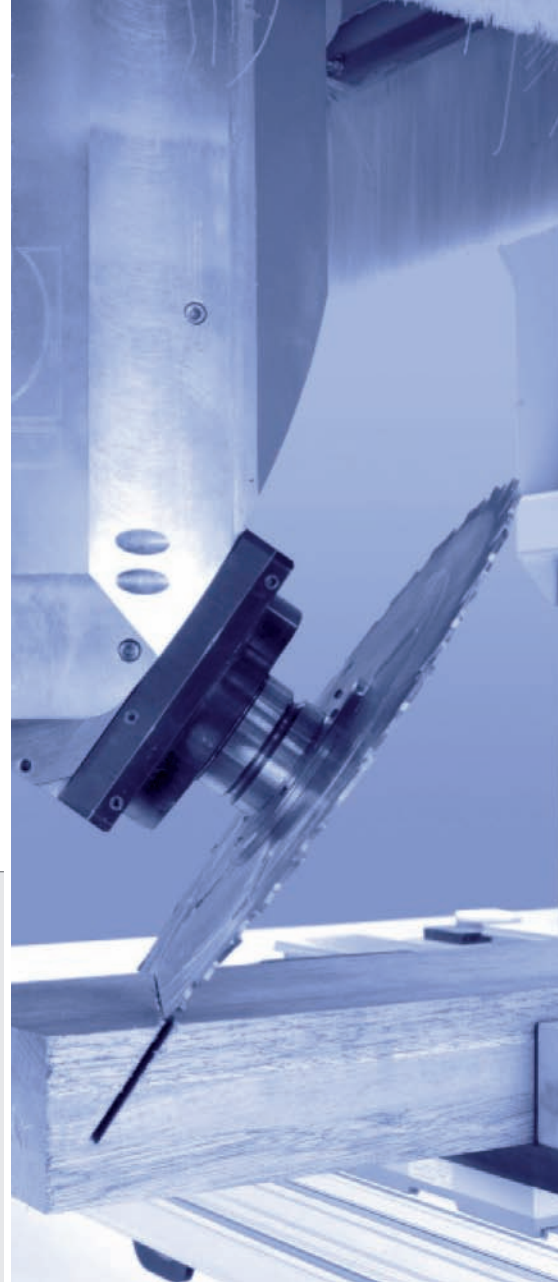

Self-explanatory icons in the input mask and additional help images simplify the input of parameters in uniform processing dialogs considerably.

Variant programs can be easily generated in woodWOP by using variables.

woodWOP DXF-Import Basic + Professional

Interface for CAD data import

– From the drawing straight into production –



The widely used, independent DXF format for the exchange of CAD drawings is used as the basis for the generation of woodWOP programs. Workpieces having been drawn once can be imported into woodWOP and transferred to the machine straight away.

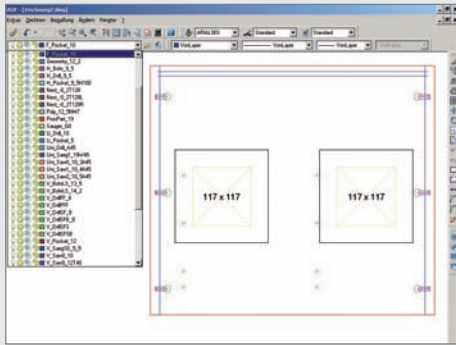

The individual layers of the drawings include all the information relevant for machining.

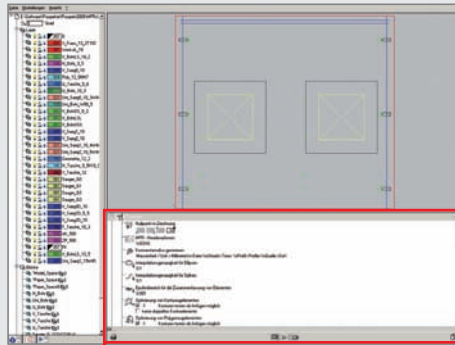

Owing to the preset set of rules any drawing element of the DXF files can be converted into machining steps.

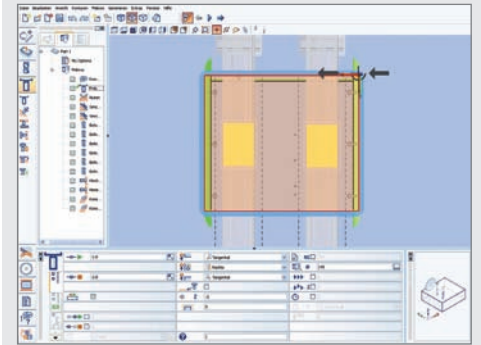

The machining steps are then generated automatically when the data is imported.

Advantages

- Workpiece has to be programmed only once.
- Straight from the drawing to the machine.
- No reworking in woodWOP necessary.

Options

- **Can be configured as required (Professional)**
Special applications can be expanded. The conversion rules can be flexibly expanded as required for each machining type. As a result, almost all possibilities can be covered by woodWOP.
- **Batch processing**
DXF Import Batch Process is an extension of DXF Import Basic or Professional. Any number of DXF files can be converted into woodWOP programs by one start process.

woodWOP MPR interface

Many software companies support the woodWOP file format *.mpr. This means they generate woodWOP programs directly from their systems which can then be imported into woodWOP and processed by the machine without having to be reworked.

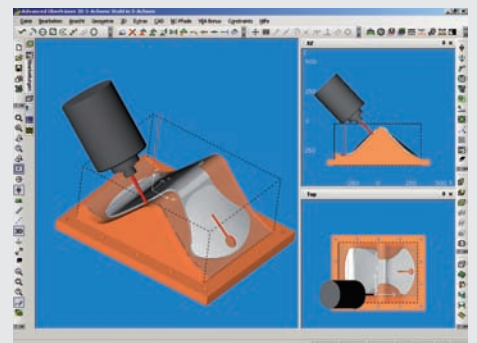
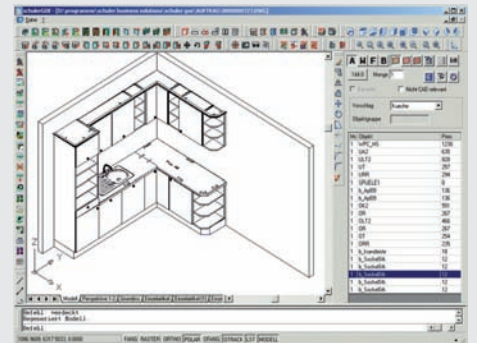
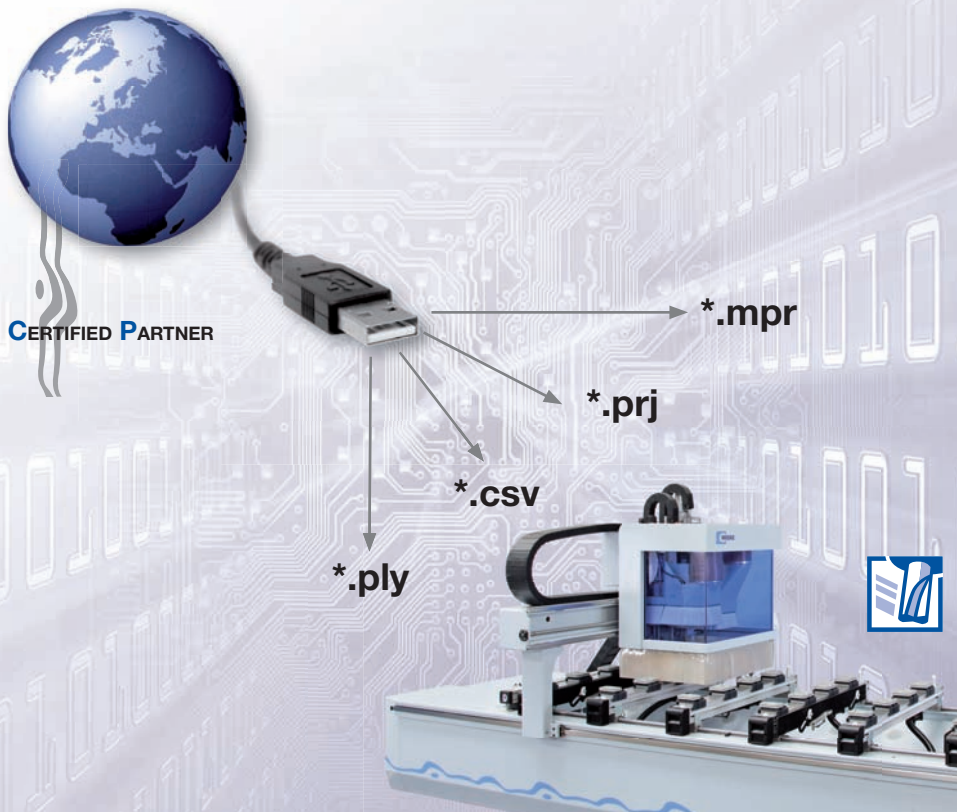

Advantages

- No additional programming required since each part has only to be programmed once.
- Interface to the most common software producers.
- Machine neutral interface, i. e. software companies generate a neutral data format. We take care of the implementation on our machines.

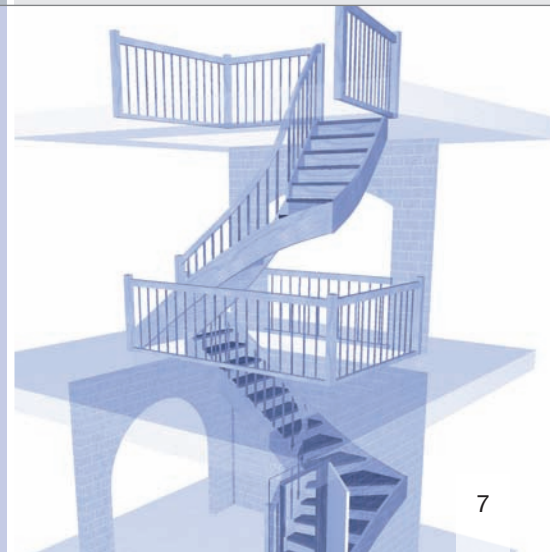

woodDesign

The new way to design and display furniture on screen



wood**D**esign is a modern 3D design tool for the interactive design of cabinet furniture. Complete workpiece programs can be prepared in seconds.

wood**D**esign allows you to program complete items of cabinet furniture instead of individual parts. The 3D display function ensures that the software is easy to use.

Advantages

- Five steps to the finished furniture!
- Generation of all production data
- The object is displayed on the screen and can be viewed realistically from all sides

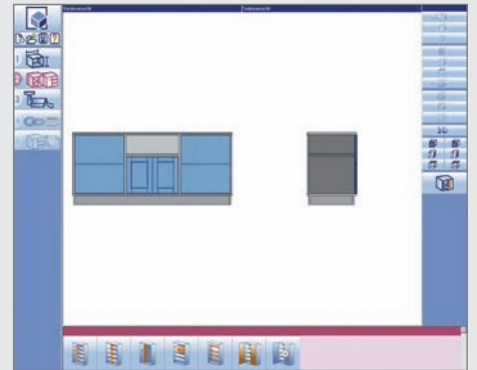
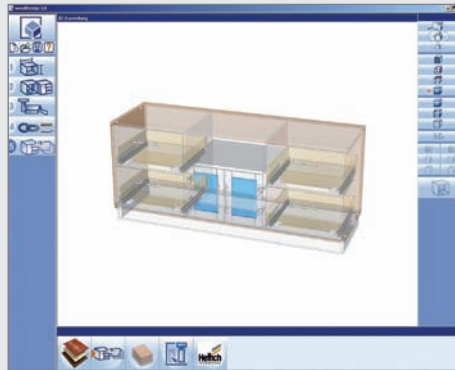

TV Moebel

woodDesign												
1	?	1	532.00 (534.00)	500.00 (502.00)	19.00 (19.00)	L 2.00 L 2.00	L 2.00 L 2.00		Teak,0.00	Teak,0.00	Teak,0.00	TV Moebel001
3		1	532.00 (534.00)	500.00 (502.00)	19.00 (19.00)	L 2.00 L 2.00	L 2.00 L 2.00		Teak,0.00	Teak,0.00	Teak,0.00	TV Moebel002
5		1	1600.00 (1602.00)	500.00 (502.00)	19.00 (19.00)	L 2.00 L 2.00	L 2.00 L 2.00	R255;G255;B255;0.00	Teak,0.00	Teak,0.00	Teak,0.00	TV Moebel003
7		1	1600.00 (1602.00)	500.00 (502.00)	19.00 (19.00)	L 2.00 L 2.00	L 2.00 L 2.00		Teak,0.00	Teak,0.00	Teak,0.00	TV Moebel004

Cut lists are generated automatically for all components to be manufactured, including the related wood**W**OP programs.

The Hettich catalog is delivered on CD with wood**D**esign, with the option of integrating it in wood**D**esign. The operator can then draw up a connector selection directly from the Hettich catalog.

Processing for the connectors can also be generated via wood**W**OP components.

woodAssembler

Virtual assembly of workpieces programmed in woodWOP

Experience with CNC machines has shown how important it is to check the individual components. Programming errors such as incorrect offset, spacing errors and incorrect coordinates cause high material costs and loss of machine time.

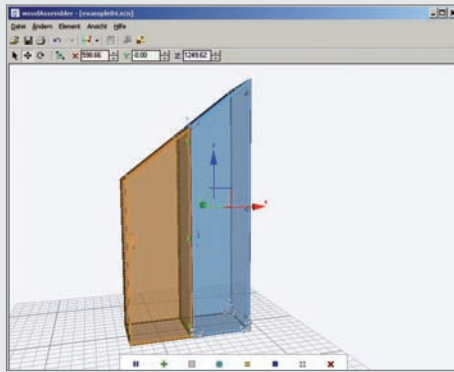
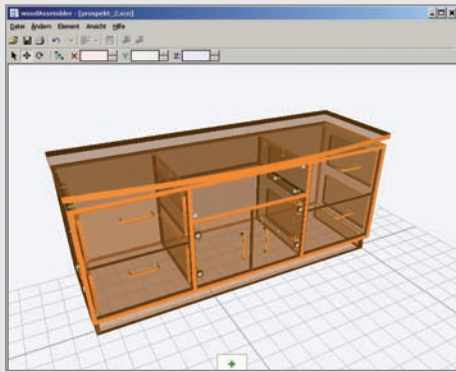

Advantages

- Errors in the programming are identified immediately
- It is not necessary to manufacture prototypes
- Particularly effective for series production or high-value materials



woodAssembler displays your projects in 3D and makes it possible to assemble components using the mouse. Your programs generated in woodWOP are used as the data source.

Realistic visualization of the design.

Modern technology makes it possible for you to check the components virtually and in this way find errors conveniently on the PC without the need to manufacture expensive prototypes. Variably created objects can be edited directly.

Nesting Solutions

Cutting and machining optimization

Nesting technology means to „nest“ workpieces in order to achieve optimum material utilization by using cutting optimization. Nesting offers the opportunity to economize significantly on materials particularly with a large variety of shaped parts.



woodNest Basic

Software for Nesting Shaped Parts

woodNest Basic is an easy solution for users who occasionally want to program nests. woodWOP programs can be manually nested, positioned and rotated with a mouse.

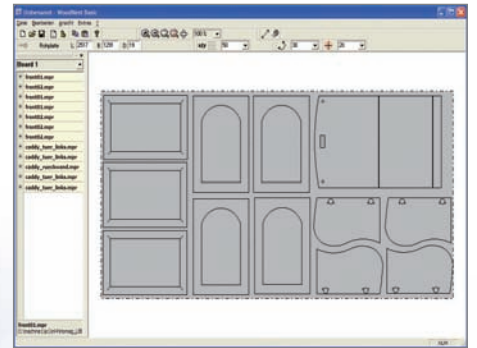

FOR WEEKE MACHINES ONLY



OfficetoMachine

Mit **OfficetoMachine** makes it possible to create and manage production lists for manufacturing on a PC workstation, which can subsequently be transferred to the machine.

There is the option to extend import, print and export functions.

- **Import** data from other systems
- **Printing** of bar code labels. Label layout can be selected individually.
- **Export** of production lists to woodNest Professional.

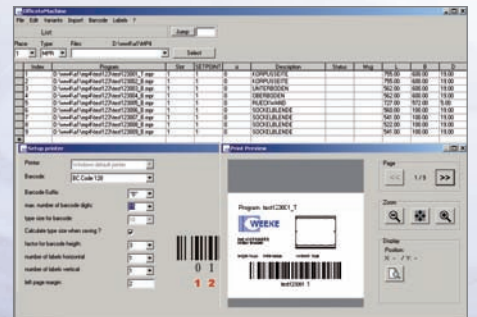

Advantages

By combining cutting and final processing intermediate stacking of individual items is not necessary. Material costs can be reduced and the overall processing time can be cut.

Software for automatically nesting shaped parts

The HOMAG Group offers two different programs for automatic nesting. In this case woodWOP programs are imported directly, placed on an unprocessed board and optimized. The nesting results are complete woodWOP programs including all machining steps optimized according to travel ranges and tool changes. Combining cutting and final processing makes it possible to reduce material costs and to shorten total processing time.

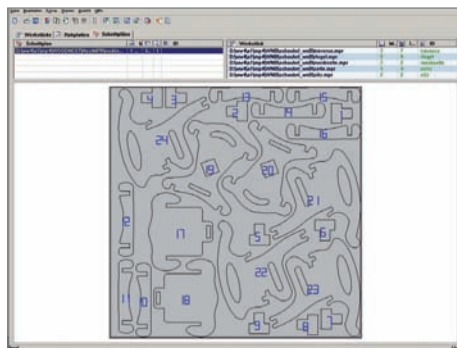
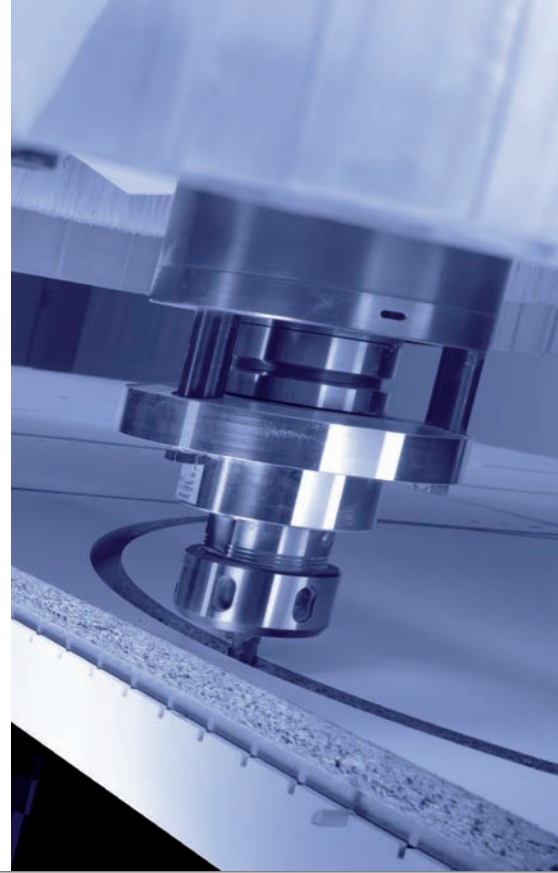

woodNest Professional

woodNest Professional is an optimization program exclusively used for the machining on nesting machines.

Any number of unprocessed boards generated in woodWOP beforehand can be administrated.

Standardized parts of varying dimensions can be defined in a variable piece list. The variable piece lists can also be used in a higher level ERP system via a defined interface.

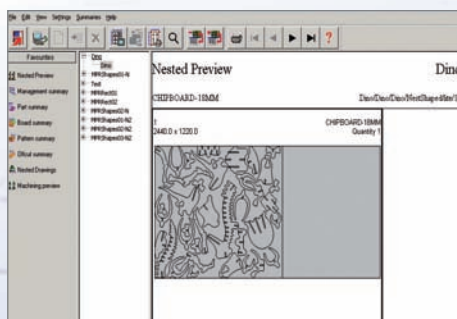

Cut Rite Nesting

Cut Rite, the optimization software of the HOMAG Group, is used for cutting boards on sawing machines as well as nesting machines. The modular structure of the software allows users already controlling their sawing machine via Cut Rite to integrate the nesting module without problems.

Highlights

- Board library and calculation of material costs.
- Labeling in the office incl. layout editor.
- Additional modules can be applied optionally, e. g. for stock management.

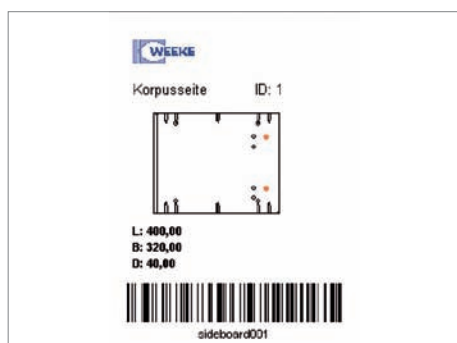

woodPrint

Automatic label-printing directly at the machine, including an import-interface for the printing data and a graphical layout editor for the labels.

Simulation and Time Calculation

Software for graphics simulation and time calculations



The programs for simulation and time calculation enable machining processes to be simulated, calculated and checked for errors already in the office.

FOR WEEKE MACHINES ONLY

3D CNC-Simulator

An automatic routine determines the machine configuration and tools fitted. The positions of suction cups and modules in the NC program are displayed and checked for collisions in the case of machining steps completely through the board.

Advantages

- The machining sequence can be simulated, optimized and pre-calculated already in the process planning department.
- Program errors are indicated immediately.
- Vacuum suction cup positions are displayed and checked for collisions with tools in the case of machining steps completely through the board.

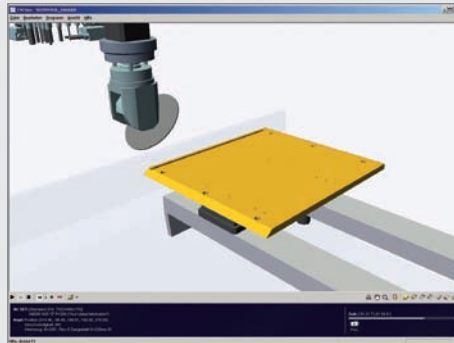

Simulation including material removal

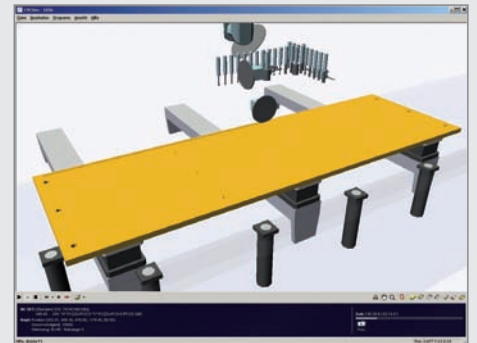

Unit layout that moves

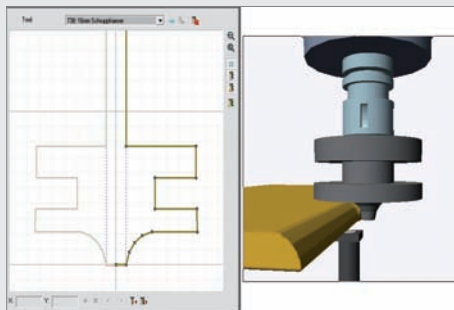

Tool profile

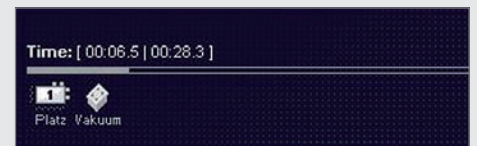

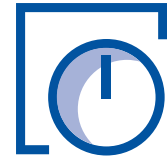

FOR HOMAG MACHINES ONLY

woodTime

Production time simulation of woodWOP programs

With woodTime workpiece runtimes are simulated in real-time and displayed sorted by processing step on a workstation computer. In addition to acceleration and deceleration times, woodTime also considers complete tool change cycles as well as approach and return times.

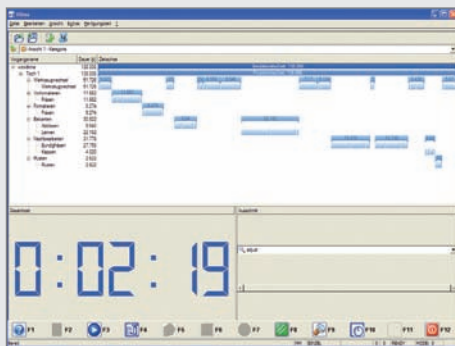

Advantages woodTime

- Simulation times of high precision. Direct use of the data for cost calculation and calculation of machine utilization.
- Exact analysis of the overall program process in order to detect unproductive downtimes.
- Original control data with display of error messages on the workstation computer

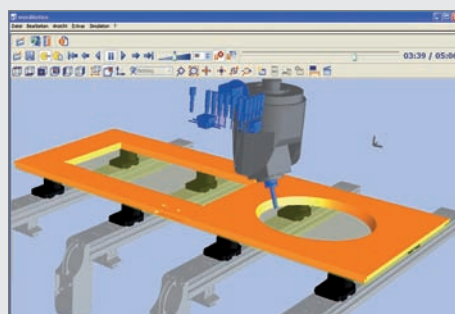
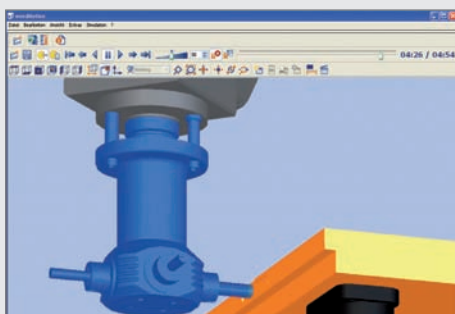

Simple creation of profiled tools by taking over tool contours drawn in woodWOP.

Advantages woodMotion

- Reduced running-in times on the machine due to optimum preparation of programs.
- Simulation of 5-axis machining including material removal.
- Collision control between tool and clamps
- Saving and taping function for simulations.

woodMotion

Machining simulation of woodWOP programs

woodMotion uses the office PC to simulate work steps at the machine, and provides a graphic representation of processing operations at the workpiece. This affords the programmer the opportunity to check the processing steps in advance and detect any potential collisions between tools and clamps.

The simulation is based on a virtual machine with a real CNC core actuated by means of the data of the respective customer machine. With this virtual machine it is possible to simulate an almost 100% realistic machine behavior on the office PC for the first time. This means: Any program which has been simulated faultlessly will also run without faults on the machine at any time.

Projectmanager

Interface to Industry Packages

This data interface allows an industry package or an ERP system to be connected to woodWOP.

This interface is based on a library with variable woodWOP programs. The Projectmanager assigns the variable values to the individual woodWOP programs (components) and fully-automatically generates new woodWOP programs.

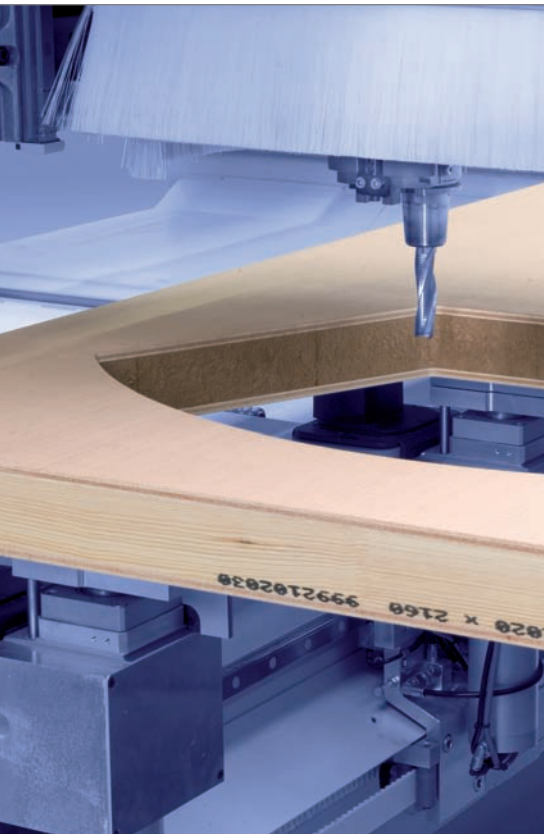

Cabinet Furniture

With woodProcess the HOMAG Group offers a complete industry solution for small and medium-sized companies. The process management system controls the entire process, from quoting, purchasing, creating production and delivery documents and providing programs for machine control, right up to settling the invoices.

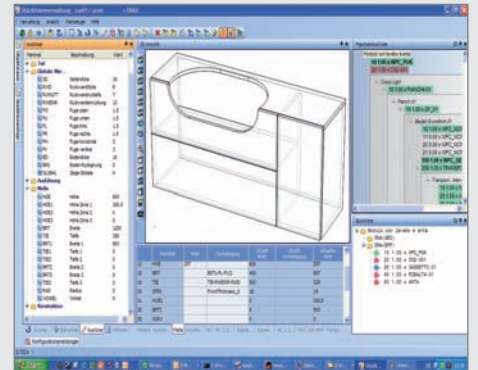

Door Production

All the essential attributes of the door can also be collected via a customer's PPS system. The machining steps are created in woodWOP as components. From these, the Projectmanager creates a door panel, a frame component or a complete door, including all machining steps such as: Formatting/profiling, Lock, Installation drill hole, Hinges, Cut-outs, Final processing for frames, Strike plates, etc.



Advantages

- Automatic generation of woodWOP programs.
- Reduction of processing times due to automatic optimization of tool change.
- Integration of customer software systems into the HOMAG environment.

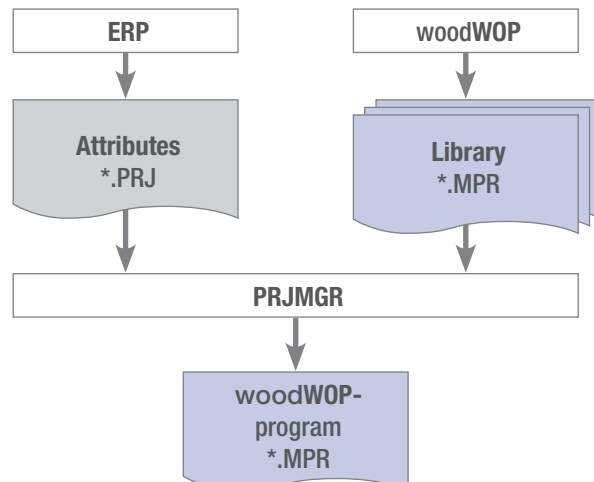

Solutions for all requirements

woodWindows

- Quick and easy input of windows via type lists or free window design
- Design of all common window shapes such as rectangle, triangle, round arches, arch segments, three-center arches etc.
- Completely prepared with master data of a window system (IV68 or IV78 or wood- aluminum) and a fitting system of the most common manufacturers.

woodWOP interface to design software for windows and front doors

- Interface to industry programs such as KLAES, 3E, ProLogic, Adulo etc.
- Automatic generation of all machining programs for window scantlings.
- Optimum table assignment by dynamic place assignment and pairing.
- Automatic calculation of the positions of clamping devices.
- Job list control allows paper-free processing of parts on the machine.

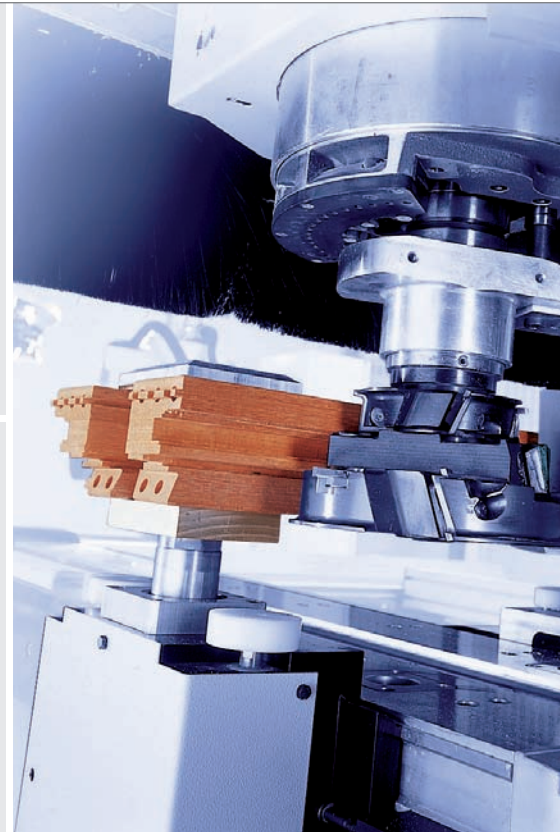
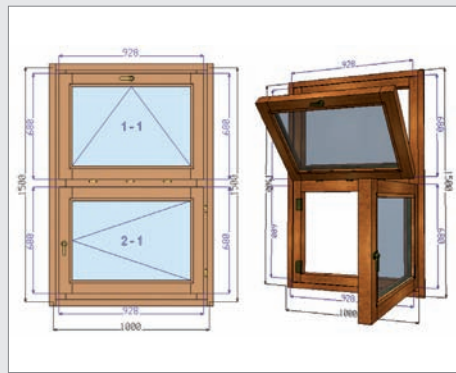
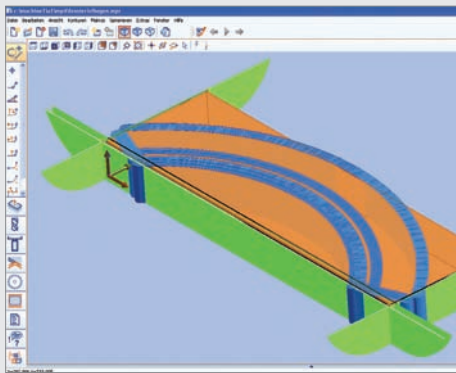
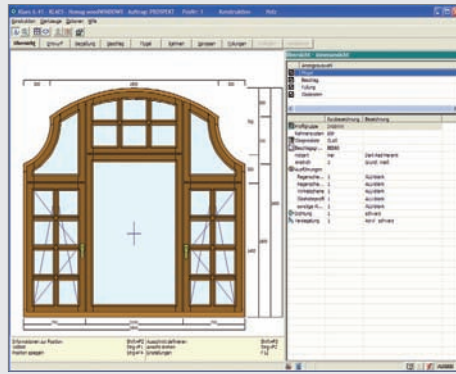
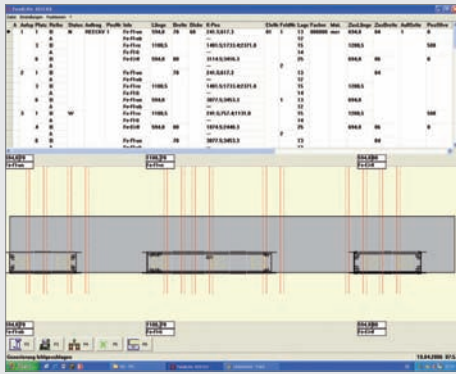

woodWOP Window/Front Door Programming

- Variable woodWOP programs for round edge sections and adapter pieces
- Variable programs for front doors with frame structure

Interface CAD/CAM Window Software

- Engineering software for simple window shapes with a blind frame
- Optional extension for additional window shapes and types of openings as well as all processing of fittings
- Interface to e.g. PowerWIN by DDX

powerControl

The control system from the HOMAG Group



powerControl is the control system from the HOMAG Group. It combines the latest hardware and software technology and ensures that our highly versatile machines are as user-friendly as possible.

Graphic Station Assignment

Station assignment enables the operator to specify which workpiece is to be produced in which clamping station. With graphic display of the eventual workpiece selection, the control system offers the maximum in safety and convenience.

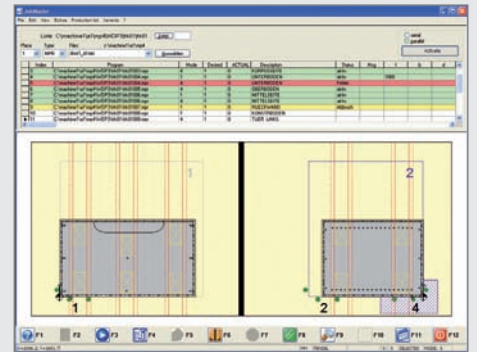

woodScout – Diagnostic System

The diagnostic system **woodScout** displays descriptive error messages and provides assistance for troubleshooting. Help images simplify the systematic detection and remedy of malfunctions.

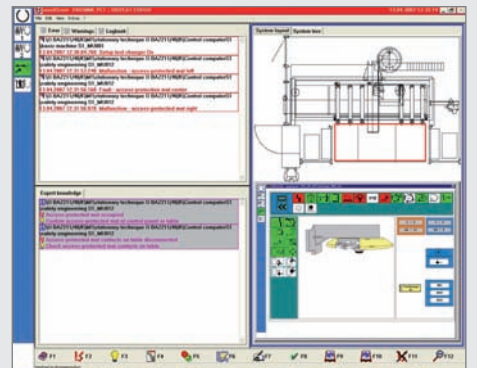

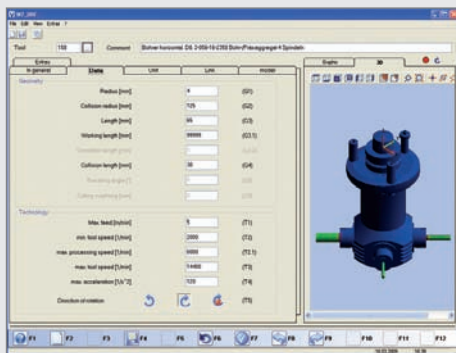
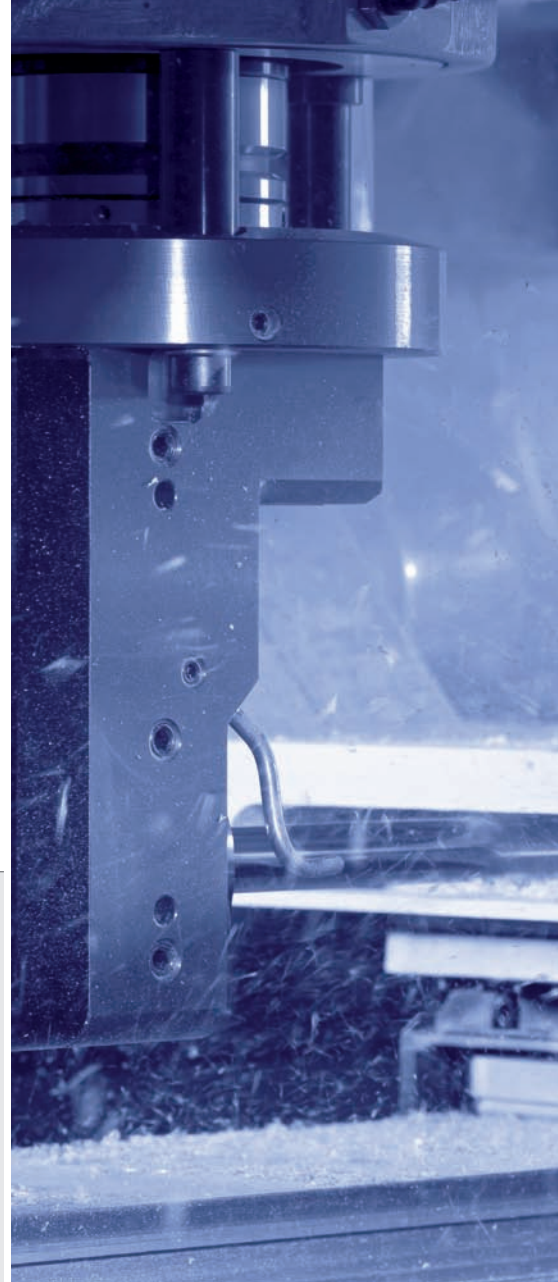

Graphic Tool Data Base

Using the graphic tool database makes entering and modifying tool data safe and easy. Dimensioned graphics help the machine operator set up new tools or processing units.

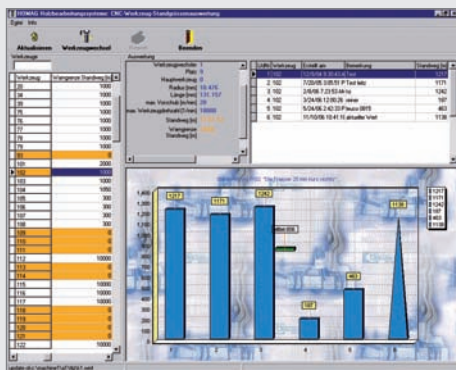

Tool Life Cycle Management (Option)

The Tool Life Cycle Management records and monitors tool utilization. This data can be used to optimize tool utilization and select the best tool for the task to be carried out.

powerControl

The control system of the HOMAG Group



Wide range of parts, batch size 1, series production, control of stationary machines, complex contours, precise processing in fast throughfeed – all requirements which can only be efficiently addressed by a perfectly coordinated and integrated control system: **powerControl**.

SCHULER MDR Basic – Machine Data Recording

Integrated counters and predefined maintenance intervals always advise the machine operator in due time of maintenance tasks to be carried out. This needs-based maintenance increases machine availability and significantly reduces downtimes due to malfunctions. In addition to maintenance data, the number of processed workpieces and runtimes are also recorded. In doing so, information on productivity is always available.

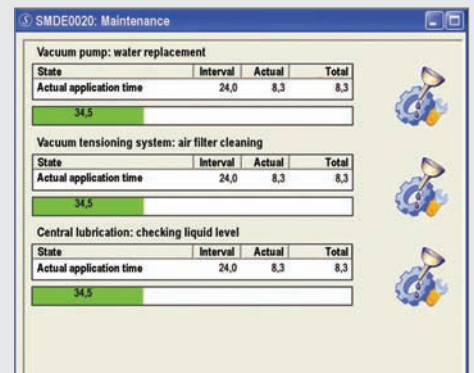

SCHULER MDR Professional (Option)

The professional version additionally offers:

- Detailed breakdown of actual application time in production time, setup time, malfunction time, and interruption time.
- Detailed breakdown of interruption time according to the cause of the interruption.
- Shift management and shift reports.

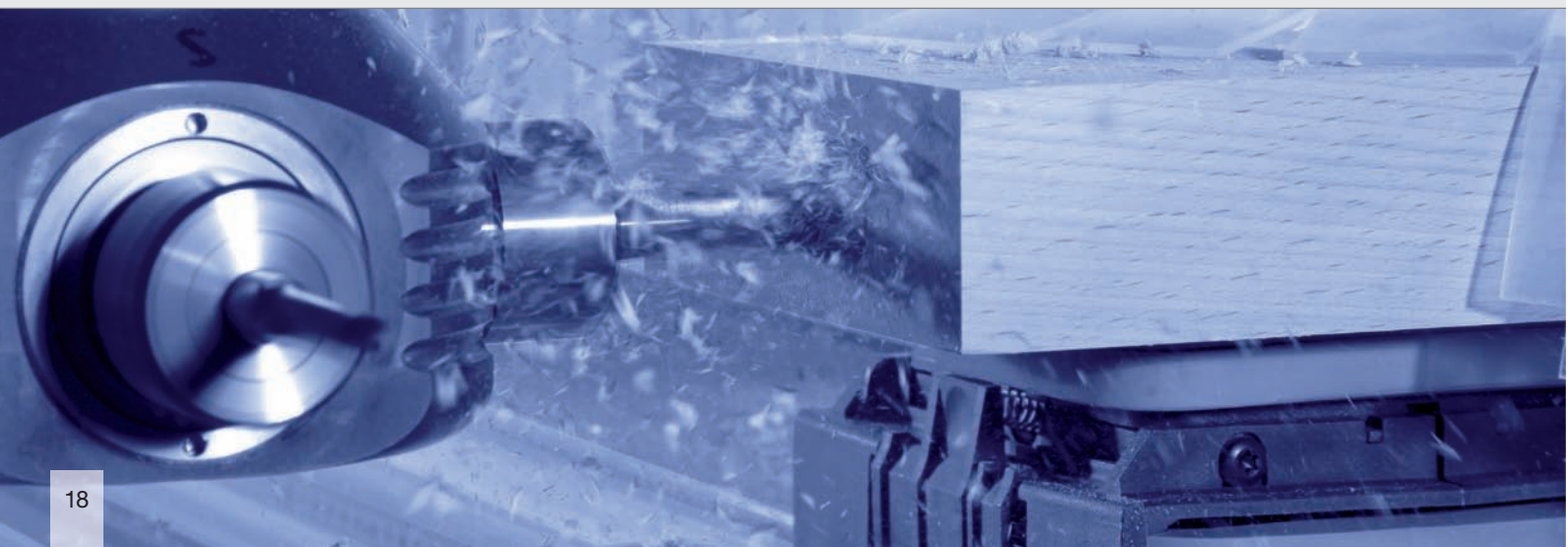

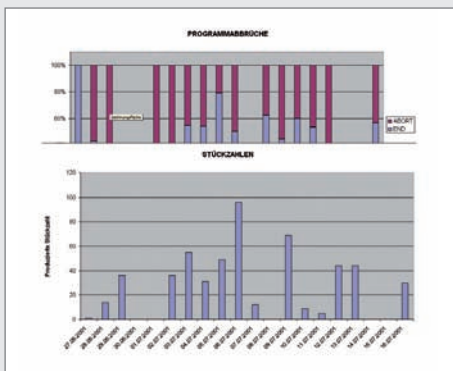

Production Report (Option)

The **powerControl** system enables recording of production events such as program start, program end or program abort in a text file (ASCII file).

If required, this information can be loaded by external production control systems and used as feedback.

FOR HOMAG MACHINES ONLY

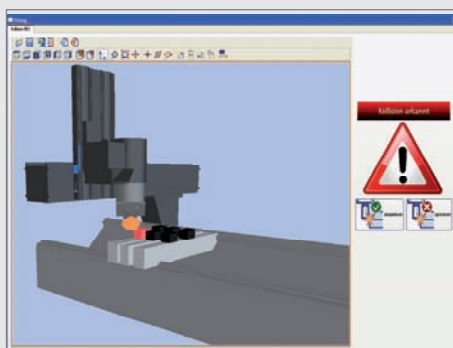

collisionControl – working area monitoring

During processing the **collisionControl** monitors possible collisions of machine components and clamping devices on the machine.

Advantages

- Automatic stop of the machine in case of an imminent crash situation.
- Display of the crash situation as a snapshot with colored colliding elements.
- Monitoring of manual movements in manual operation.
- Depiction of machine as a moving 3D model in live operation (No simulation, no material removal!)

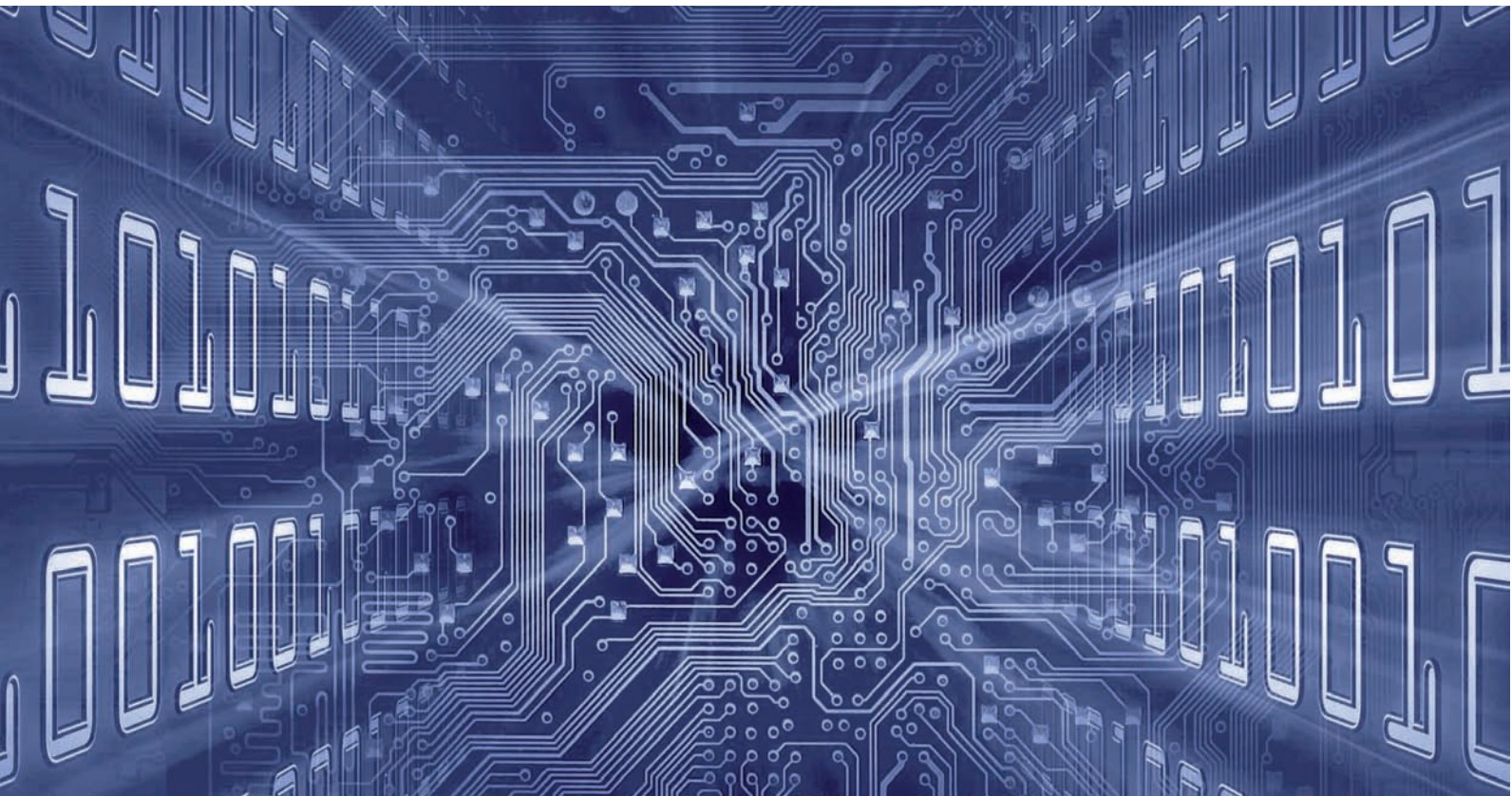

WEEKE Bohrsysteme GmbH
Benzstrasse 10-16
33442 Herzebrock-Clarholz
GERMANY
Tel.: +49 5245 445-0
Fax: +49 5245 445-139
info@weeke.de
www.weeke.de



HOMAG Holzbearbeitungssysteme AG
Homagstrasse 3-5
72296 Schopfloch
GERMANY
Tel. +49 7443 130
Fax: +49 7443 132300
info@homag.de
www.homag.de