

PRESSES AND PLANTS

For woodworking industry

LAS

THROUGH-FEED PRESS WITH ELECTRONIC CONTROL, FROM 5 UP TO 10 DAYLIGHTS

The system opens, loads and unloads one intermediate daylight **keeping constant the pressure in the upper and lower daylight**s, with following main advantages:



HIGH SPEED FOR HIGH PRODUCTIVITY
up to one door every 20 seconds
pressing one door per daylight: for the
best quality of gluing and surface
quality of the product.

FAST GLUES

It is possible to use BI-component glues with water base: ureic (UF) and vinylic (PVA) with highly reduced pressure times, no risk of precatalization of the glue since the **panel is immediately loaded** after composition. LAS can also use BI-component **polyurethanic glues (PU)**.

REDUCTION OF THE COVERED SPACE

as regards the single-daylight or simultaneous loading multidaylight presses with equal platen working surface.

PLATENS WITH HIGH THERMAL EFFICIENCY

A **SERGIANI exclusive** to press at **low temperature** with higher productivity as regards the drilled solid platens keeping the mechanic, static – dynamic high resistance.



MAX. PERFORMANCE WITH BEST TECHNOLOGY

LINE WITH LAS

PLANTS FOR COMPOSITION AND
PRESSES FROM 400 UP TO MORE
THAN 1.600 CYCLES PER SHIFT

- 3 or 5-layer **flush doors**
- **Door laminating**
- **Technical doors**
- **Furniture flush panels**
- 2 or 3-layer **pre-finished parquet**

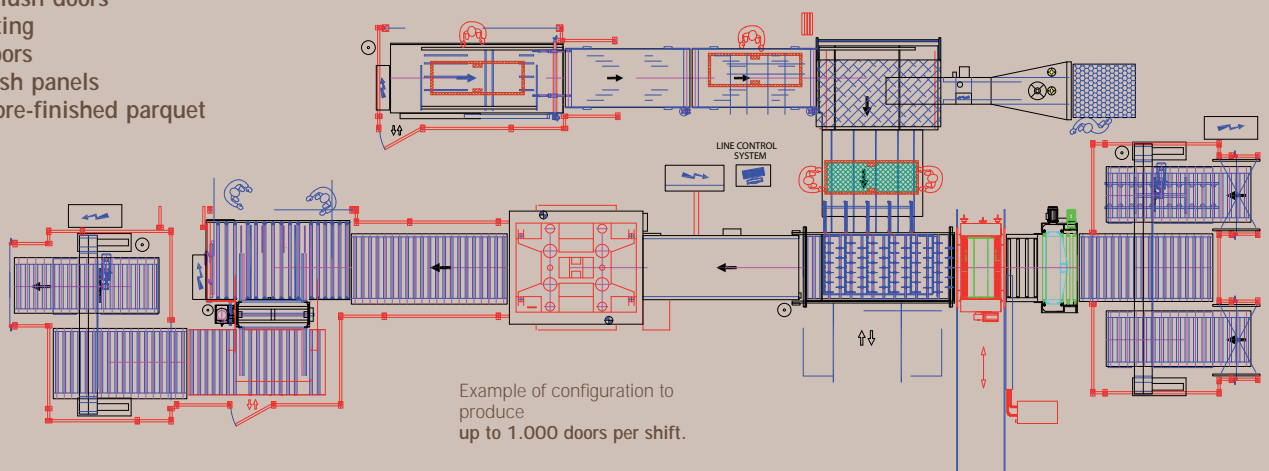

INTEGRATED SYSTEMS FOR HIGH PRODUCTIVITY

Panel composition lines with different automation levels, from traditional configurations up to **COMPLETELY AUTOMATIC PLANTS WITHOUT OPERATORS IN THE LINE.**

Programming, managing and control of the machines in the line with **SOFTWARE SERGIANI "LCS" - Line Control System** and **SOFTWARE SERGIANI "LEOmes"** to manage the production and batch programs; e.g. according to the order of final customer. Possibility to use **BAR CODES** or **MICROCHIPS**.

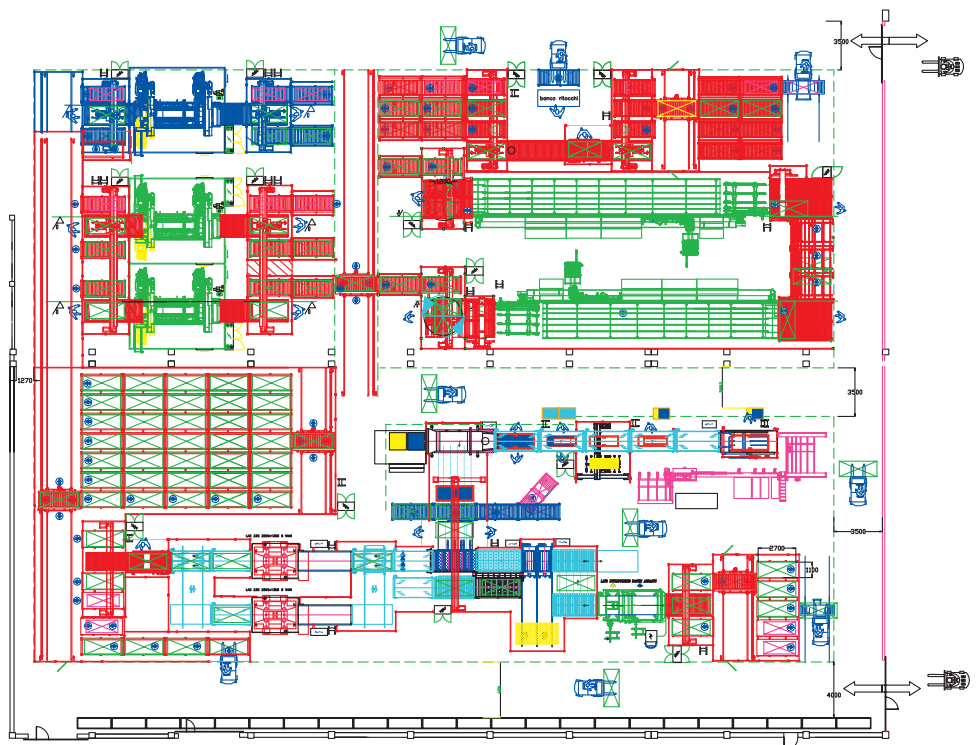

BVC

AUTOMATIC PRESS WITH 2 INDEPENDENT DAYLIGHTS IN THE SAME STRUCTURE

LINES FOR "BATCH 1" PRODUCTION

with two or more two-daylight presses positioned in parallel, fed unloaded and controlled by line software.

For each panel or panel group it is possible to modify **PRESSURE, PRESSING TIME AND TEMPERATURE** (with proper plant) according to the dimensions and features of the panels to produce.

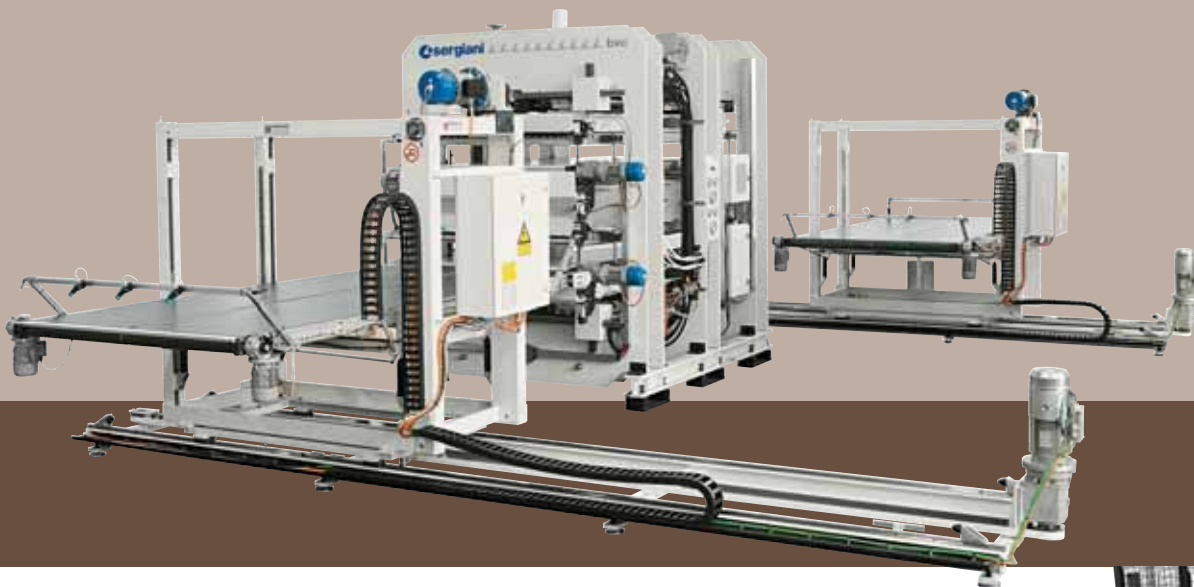

LINES FOR LAMINATING OF FURNITURE PANELS WITH HIGH AND FLEXIBLE PRODUCTIVITY.

veneering, HPL, CPL or PAPERS

One daylight is always under pressure while the other one is loaded/unloaded, with reduction of the "dead times".

Furthermore the **occupied space is halved** as regards one single-daylight press with equal platen working surface.



INTEGRATED SYSTEMS FOR MEDIUM AND HIGH PRODUCTIVITY

- 3 or 5-layer flush doors
- Door laminating
- Technical doors
- Furniture flush panels
- 2 or 3-layer pre-finished parquet
- Multilayer panels
- Furniture laminated panels

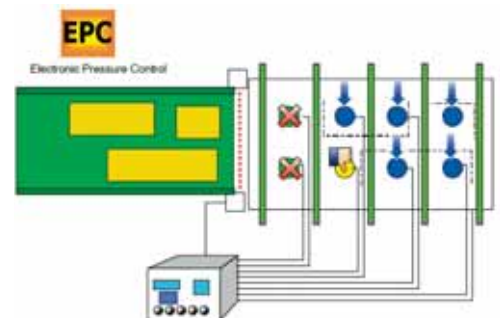

AUTOMATIC PRESS FROM 2 UP TO 10 DAYLIGHTS WITH SIMULTANEOUS LOADING/UNLOADING

MLT

PRESSES FOR HIGH SPECIFIC PRESSURES, FROM 5 TO 20 KG/CM²

- Construction with MODULAR system: sturdy structure with pairs of ribs cut from solid steel, supporting the thrust cylinders. The standard module system allows the widest configuration flexibility of the press according to the process

requirements and the required productivity.

- Solid steel platens with high thickness, drilled and CNC worked
- Cylinders with exclusive SERGIANI design for max. reliability over time



AUTOMATIC PLANTS

Wide range of line configurations available for:

- 2 AND 3-LAYER PARQUET

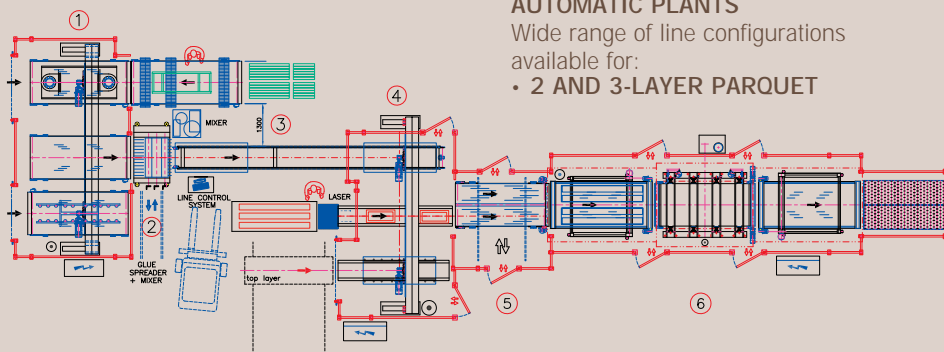

- MULTILAYER PANELS for building and covering.
- TECHNICAL PANELS

Panel composition lines with different automation levels: from traditional configurations up to **completely automatic plants without operators in the line** with managing and control through the SERGIANI softwares.

Wide range of solutions available for the different customer requirements

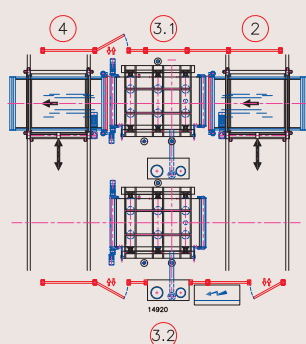

PLANTS FOR HIGH PRODUCTIVITY AND HIGH FLEXIBILITY OF THE PRODUCTION

With 2 or more multidaylight presses positioned in parallel, fed unloaded and controlled by SERGIANI line software. Pneumatic, electronic devices and software for fast loading/unloading.

Wide range of standard press platen dimensions available according to panel dimensions and required productivity levels.

MVC

MVC SINGLE-DAYLIGHT AUTOMATIC PRESS WITH HOT PLATENS AND ELECTRONIC CONTROL

WIDE RANGE OF VERSIONS

Panel loading on narrow side or on long side of platen according to required production process and line configuration. Platen width from 1.400 up to 3.500 mm, platen length from 2.600 up to 8.000 mm.

FLEXIBLE CONFIGURATION OF THE PRESS

Construction with MODULAR system: sturdy structure with pairs of ribs cut from solid steel, supporting the thrust cylinders. The system, composed by rib modules and standard platen dimensions, allows the

widest configuration flexibility of the press according to the type of product, process and required productivity levels.



PRESSES SUITABLE TO A WIDE PRODUCT RANGE

- High specific pressures: from 5 up to 15 Kg/cm²
- Platens in high thickness solid steel drilled and CNC worked
- High finishing platen surface to obtain the highest product quality, even with superglossy laminated panels (HIGH GLOSS)

- Cylinders with exclusive SERGIANI design for max. reliability over time
- Electronic control: flatness, daylight opening, closing and loading/unloading speed + mechanic and pneumatic devices to increase the productivity and for energy saving.



MVF AUTOMATIC SINGLE DAYLIGHT COLD PRESS WITH ELECTRONIC CONTROL

MVF

AUTOMATIC PLANTS

Wide range of line configurations available for:

- LAMINATED PANELS FOR FURNITURE with veneer, HPL, CPL or papers
- DOORS LAMINATING
- FLUSH DOORS with productivity of 200÷300 doors/shift
- 2 and 3-LAYER PARQUET
- MULTILAYER PANELS for covering.
- TECHNICAL PANELS

Panel composition lines from traditional configurations up to COMPLETELY

AUTOMATIC PLANTS WITHOUT

OPERATORS IN LINE with managing and control through SERGIANI softwares.

Wide range of solutions available for the different customer requirements with different automation levels

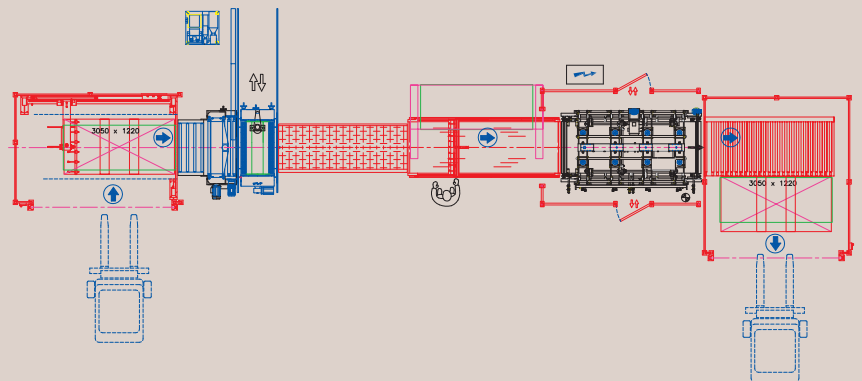
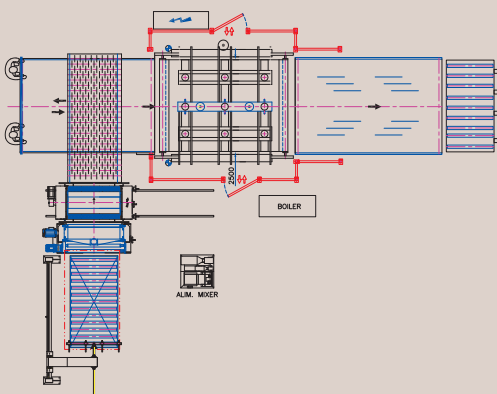
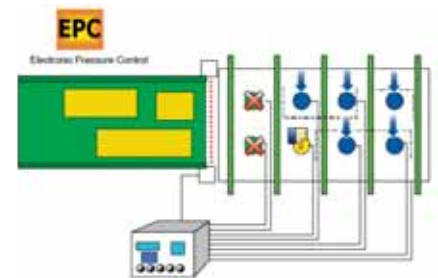

- AUTOMATIC "COLD" PRESSES MVF:** with same technology and modular structure system as MVC presses a range of SINGLE-DAYLIGHT COLD PRESSES is produced to press panels in stack at ambient temperature
- Standard daylight opening 1.200 mm, cylinder stroke 600 mm.
 - Solid steel platens – Upper platen

- movement from top to bottom
- Automatic loading of the stack with motorized chains or manual loading with retractable wheels
- Specific pressures from 5 Kg/cm² up to 15 Kg/cm²
- Electronic control of the press with display operator panel.

Plant solutions available with different automation levels to realize composition, loading and unloading lines from traditional configurations up to COMPLETELY AUTOMATIC PLANTS WITHOUT OPERATORS IN LINE with managing and control through SERGIANI softwares.

CM - SP 5 SL 5 - ASP GRV

PANEL COMPOSITION STATIONS AND LOADING/UNLOADING AUTOMATIONS FOR PRESSING LINES

Composition station CM for laminating of doors or panels with medium – big dimensions. Motorized version with manual or automatic control. Sheet support lateral or frontal - motorized. Single or double support.



Composition station SP 5 for 3 and 5-layer flush doors, technical doors and door laminating. Station connected to press LAS to produce up to 1.000 doors per shift with 2 operators.

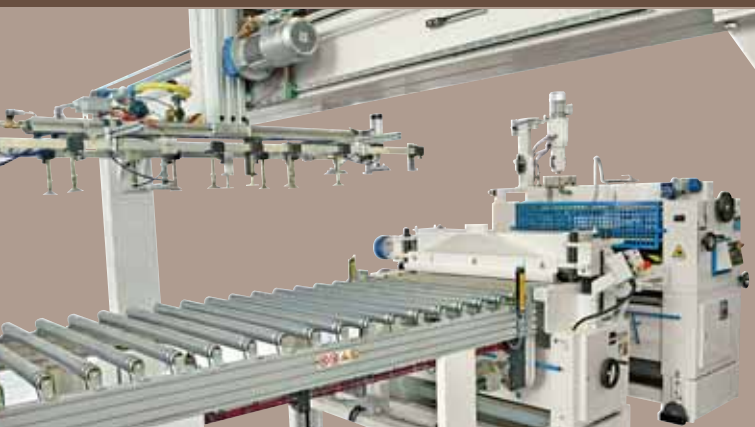

Loader in bridge execution SL 05 to feed panels or doors in the brushing machine and in the gluespreader. Special vacuum cups and devices for panel separation from the stack with 4 functions according to panel type. Door weight up to 150 Kg.
Unloader in bridge execution SL 05 with vacuum cup or self-centering clamp frame.



Loader with pushing device ASP with rear pushing arm for panels with min. thickness 6 mm.
Loader with pushing device ASPV with special vacuum cup frame for thin panels, with min. thickness 2 mm. Roller device for panel dragging and thickness control.
Loader with the two systems ASP + ASV in combination.

Vertical cooling station GRV or horizontal version GRO for the doors fed out the press. It reduces door stocking during the stabilization phase.

PANEL COMPOSITION STATIONS AND AUTOMATIONS FOR PRESSING LINES

SP 200 - MP 4 ROBOPRESS GRAFMATIC

Composition station SP 200 derived from station SP 5, allows the laminating of **heavy doors or panels** without any effort for the operators thanks to the loader in bridge execution with asymmetrical clamps.

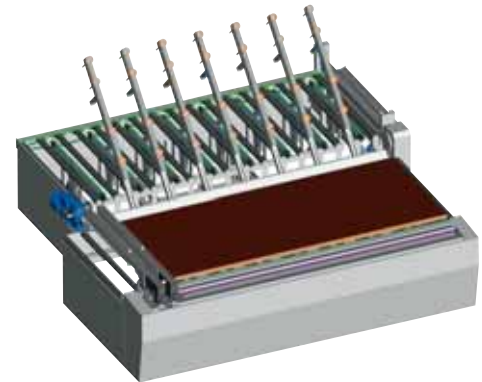

Composition station MP4 for 180° panel tilting. It is particularly utilized for composition of **3-LAYER doors** in **automatic** mode without operators.



Automatic unloader **ROBOPRESS** for press **LAS** in case of doors with **very delicate surface**, as PVC or gloss laminates. The vacuum frame picks up the door in the press daylight and deposits same outside without rubbing on press platen.



Automatic stapler **GRAFMATIC**

- with staples, for **door frames**
- Manual loading of the wood beams for the **flexibility in size change**: version with **controlled axes** and **automatic adjustment in 2.5 seconds** or manual adjustment
- Productivity: **2,5 ÷ 3 frames per minute**
- Precise and constant staple positioning

- Application pressure adjustment
- Interchangeable stapling guns
- **When connected** to the composition station it **avoids** the upper/lower stapling of the frame, the stock and the handling of the frames made in another department.
- Motorized conveyors with **LASER** devices to realize **special frames**.

SM CNC SM SUPER

AUTOMATIC FRAME PRESS FOR WINDOWS AND DOORS WITH ELECTRONIC CONTROL



APPLICATION, PROCESS and OPTIONAL

Automatic assembly of **windows, frames or doors in solid wood** with **foxtail wedging or draw pins**, with high time saving as regards the manually controlled frame presses.

- Dedicated devices and cycle for **pre-finished frames** and for shutters
- Programmable automatic opening
- **7" Touch Screen colour** operator panel
- **Interface for data transfer** from customer PC and complete **diagnostic**
- **Automatic cycle** – 1 and 2 **semi-automatic cycle** – manual cycle
- **Automatic positioning of lower beam**: a high time saving
- **Guide for shutter bar** with fixed or variable pitch
- **Pneumatic locking devices** of the wood beams: to avoid the frame pre-assembly
- **Intermediate beam** with squaring fence and cylinder for frames with intermediate stile
- **TEFLON covering** of the working surfaces for protection against corrosion
- **Orientable squaring fences** for frames with an oblique side
- Possibility to work with **codes**, by a **list, in line** with other wood beam production machines or with Leomes Sergiani software for the programming of production batches
- Working dimensions: **3.000 x 2.000 - 3.500 x 2.000 - 3.500 x 2.500 mm**
- Max. vertical pressure **14 ton** - horizontal **6 ton**



LOCKING AT PROGRAMMED LEVEL

The operating principle is based on **hydraulic movements with electronically controlled axis**. During the closing phase (automatic cycle) the upper beam and the right side squaring fences move **with precision until reaching the programmed level, no further**. To reach the level an increasing pressure is applied up to reach a programmed threshold.

The hydraulic system **avoids the disadvantages of the system with cylinders moved by worm screws** that do not allow the closing at a programmed level but only, approximately, "by pressure". Furthermore the hydraulic system **is not affected by the wear** of the components as a worm screw system, avoiding the maintenance interventions and the cost of the spare parts.



AUTOMATIC FRAME PRESS SM SUPER WITH ELECTRONIC CONTROL

with an **optimum price/performance rate**. As regards model SM CNC it closes by pressure, not at programmed level and has no possibility of data transfer, therefore it cannot have the above mentioned optionals as bar codes etc. The frame press is anyway automatic, it allows to carry out same process types, has same constructive features and the outfit of the other optionals. Furthermore it can have the piece recognition through photocells.

PRESS WITH ELECTRONIC CONTROL FOR BLOCKBOARD PANELS AND MULTILAYER BEAMS

GSLA

EXCLUSIVE AND INNOVATIVE DESIGN of upper mobile platen and of contrast hydraulic bar allowing to reach an horizontal pressure up to 45 ton.

- Gluing quality improvement even with hard woods

- Visual quality improvement of panel surface since the width tolerances of wood beam are compensated
- Pressing time is decreased with productivity increase

- It is possible to realize high thickness panels and multilayer beams of optimum quality and with same press, thanks to the high horizontal pressure and the useful opening of 150 mm.



MAIN FEATURES

- Production in THROUGH-FEED or by single panel
 - Possibility to produce panels in multirow, in through-feed or by single groups
 - Production in through-feed up to 80 mm thickness with contrast bar acting as pushing device
 - Production by panel or single group up to 150 mm with contrast bar acting as stop
 - Solid steel platens for heating with electric boiler for water or oil
 - Multilayer platens, dedicated devices and protections for high frequency generator heating
 - Platen covering in superglossy stainless steel to protect the platens, ease the cleaning and for a long life
 - Basic press versions for manual composition of wood beams
- 2.500 - 3.000 - 3.500 x 1.300 mm

- Independent adjustment of horizontal / vertical pressure and of contrast hydraulic bar with automatic pressure recovery.

Automatic plants for wood beam composition available in the configurations dedicated to the different wood beam dimensions and different product types.



MVF

COLD PRESS WITH ELECTRONIC CONTROL FOR "XLAM" WALLS OF WOODEN HOUSES



SPECIFIC PRESSURE UP TO 8 Kg/cm² ON THE WALL

to always grant the best gluing quality of a load bearing wall, with the different types of utilized wood. In this way it is possible to avoid the wastes during the tests for the certification with **high saving on the product costs** and the necessary pressing time is reduced.

FLEXIBLE CONFIGURATION OF THE PRESS

Modular system construction: each module is an independent press unit **3.200 x 2.440 mm**. The press units are connected at Customer's factory to form the required **press length:** e.g. 9.760 - 12.200 mm etc. Each module is made by a **sturdy rib structure**.

The **great reliability** and the **electronical / mechanical devices** of these presses come from the constructive technology of MVC range, fruit of **more than 60 years of Sergiani experience**.

- **Solid steel platens**
- Daylight opening **650 mm** to press **2 or more superimposed XLAM walls**
- **Optional lateral and frontal hydraulic alignment devices** to be applied when required by the working process upstream the press.

Integrated automatic plants

SCM Engineering and the firms of **SCM Group** can supply a complete plant for manufacturing of XLAM wall from the single raw board up to the finished wall.

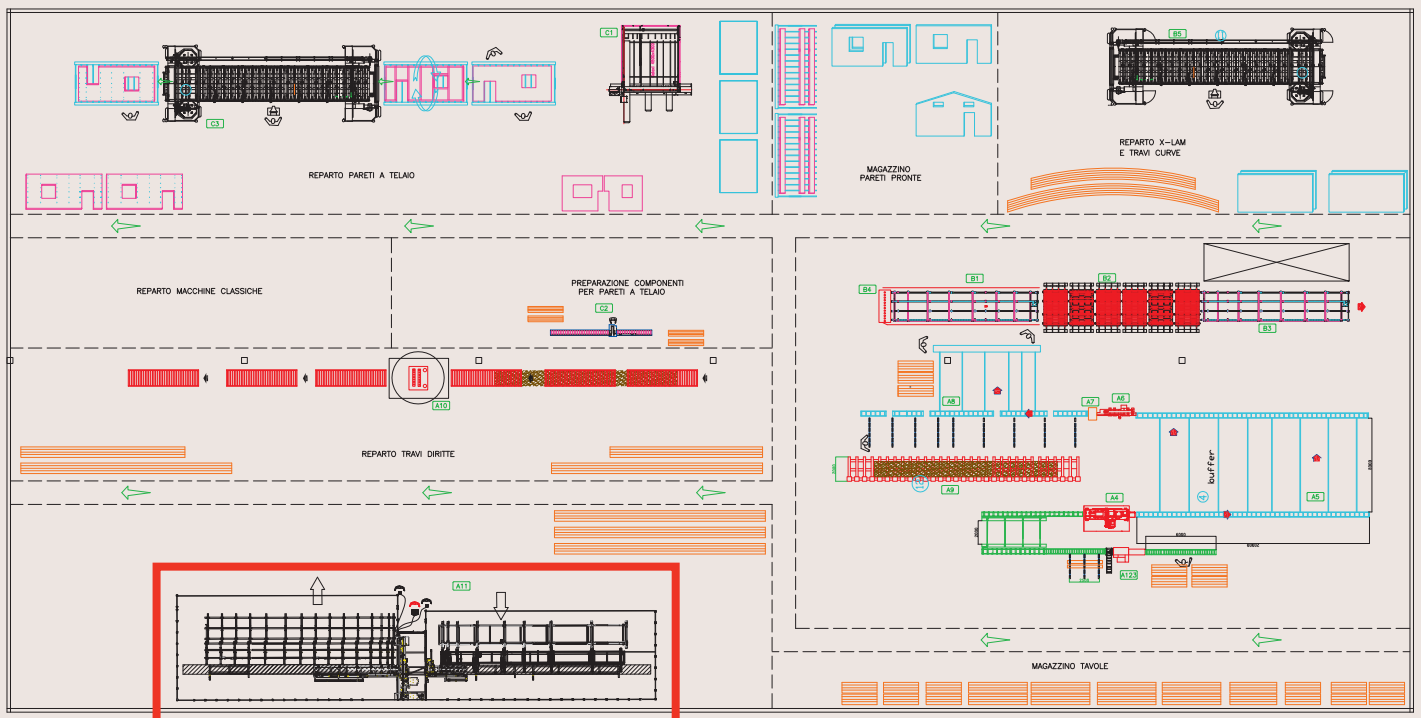

AUTOMATIC HORIZONTAL FRAME PRESS FOR STRAIGHT, CURVE, "S" SHAPE AND STEPPED LAMINATED WOODEN BEAMS

STL

STL "SUPERFLEX", SERGIANI
EXCLUSIVE INNOVATION:
AUTOMATIC HYDRAULIC FRAME
PRESS WITH ELECTRONIC CONTROL

Advantages as regards the traditional frame presses:

- **High labour reduction**
the hydraulic system with electronic

control allows to perform the **locking cycle in automatic mode**, or by wireless remote control piloted sequences

- **Increase of department productivity**
the ROBOT positions and rotates the columns in automatic mode while the operators are working on the other processing phases. Possibility to lock pairs of beams and up to 3 different beams at the same time
- **Higher and constant product quality**
for certified beams in compliance with the norms, thanks to the hydraulic/electronic system and to the **automatic pressure recovery**. Furthermore the wastes are reduced with high **saving on the costs**.



MAIN FEATURES

Automatic pressure recovery according to material subsidence.

Robot for automatic positioning and column rotation according to the beam curve to realize.

Software to import beam drawing and column positioning.

Wireless remote control.

Specific pressure up to 10 Kg/cm² for gluing quality with different wood types.

Modular construction with base beams and column distance 400 mm.

Useful width from 8 up to 32 meters and more.

Min. curve radius 3 meters.

Beam thickness from 80 up to 300 mm.

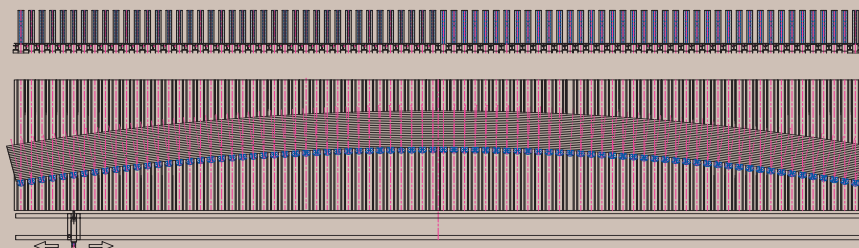

OTHER FRAME PRESS VERSIONS

- Completely mechanic with manual column positioning and manual locking through compressed air gun.
- In addition to the above, the Robot + columns positioning software.

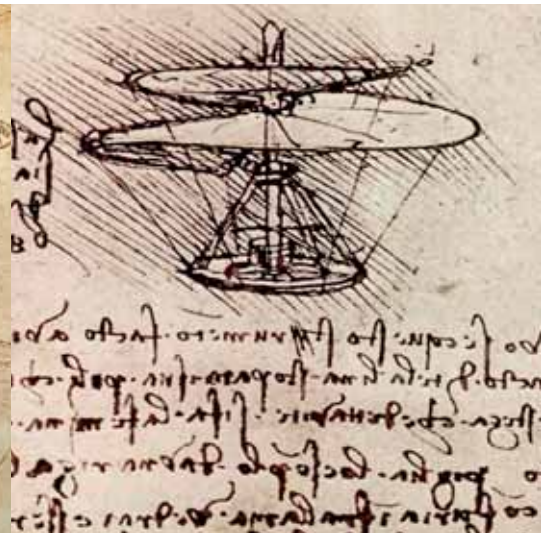
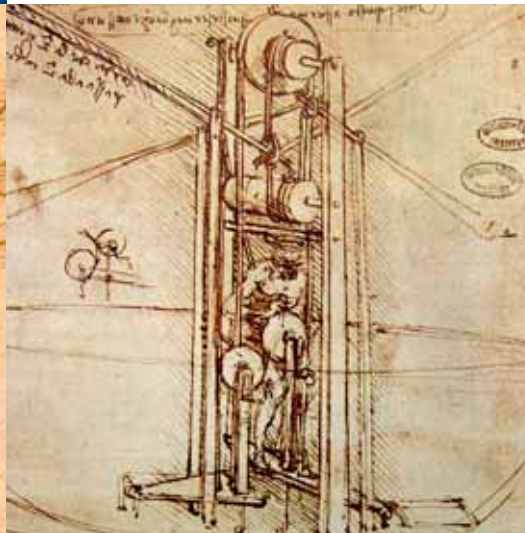

SCM Group is a leading industrial group, in the design, production and distribution of technologically advanced solutions for processing a wide range of materials: wood, glass, plastic, marble, metal, composites.

With specialist brands in the different application sectors and centres of excellence qualified in industrial components, SCM Group is present for over 50 years in the 5 continents.

PASSION. Passion for our work, focus on people, creative genius, determination and talent for team work.

TECHNOLOGY. Scientific exactness that turns creativity into technologically advanced solutions, affordable and able to create competitive advantages.

PERFORMANCE. Our commitment which results in success of our customers who choose SCM Group; the means of being considered supplier of "long-lasting competitive advantages".

SINCE 1947, MORE THAN 60 YEARS
OF EXPERIENCE AND SKILL AT
CUSTOMER SERVICE

 sergiani



Sergiani offers composition and pressing lines integrated in production process with different automation levels. In co-operation with SCM Group Engineering, Sergiani can realize a wide range of press configurations and plant solutions designed on customer particular requirement.

- Single-daylight presses with hot platens with manual or automatic loading
- Presses to curve panels in High Frequency
- Presses to produce glued beam panels
- Cold presses
- Automatic multidaylight presses
- Frame presses for windows and doors with manual control or electronic control
- Vertical / horizontal frame presses for straight, curve, or stepped laminated wooden beams

The technical data can change according to the chosen composition. For demonstrative requirements some pictures reproduce machines complete with accessories. Without prior notice the technical data can be modified, the modifications do not affect the safety foreseen by EC norms.



0000569307A

Rev. n. 00 - 05/2011 - Acanto comunicazione - Olimpia - Pazzini



SCM GROUP SpA - SERGIANI - Via Casale, 450 - 47826 Villa Verucchio (RN) - Italy
Tel. +39/0541/674111 - Fax +39/0541/674235 - www.scmgroup.com - sergiani@scmgroup.com