

The best partner for woodworking industry

Complete solution for any woodworking production requirement

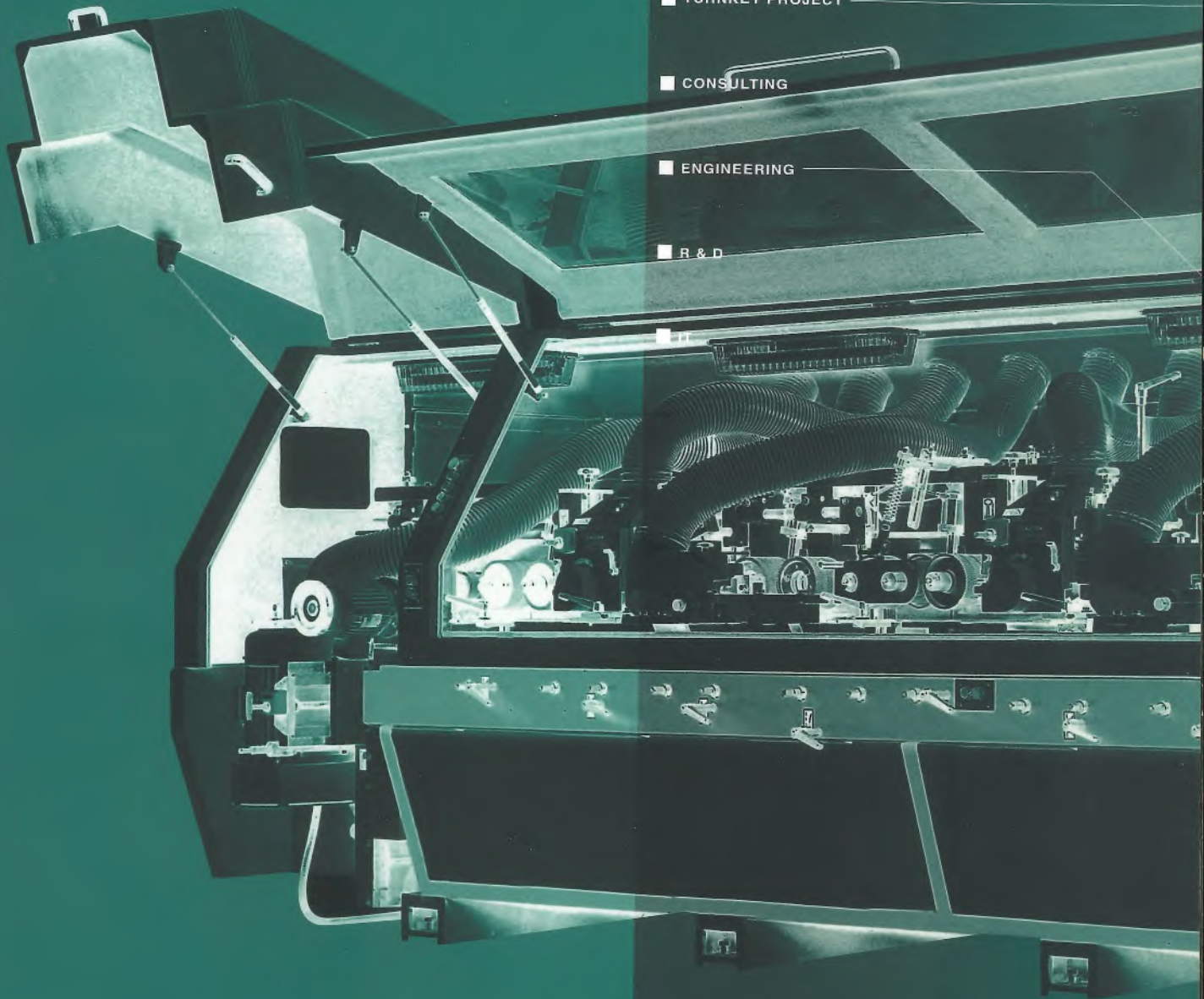

■ TURNKEY PROJECT

■ CONSULTING

■ ENGINEERING

■ R & D

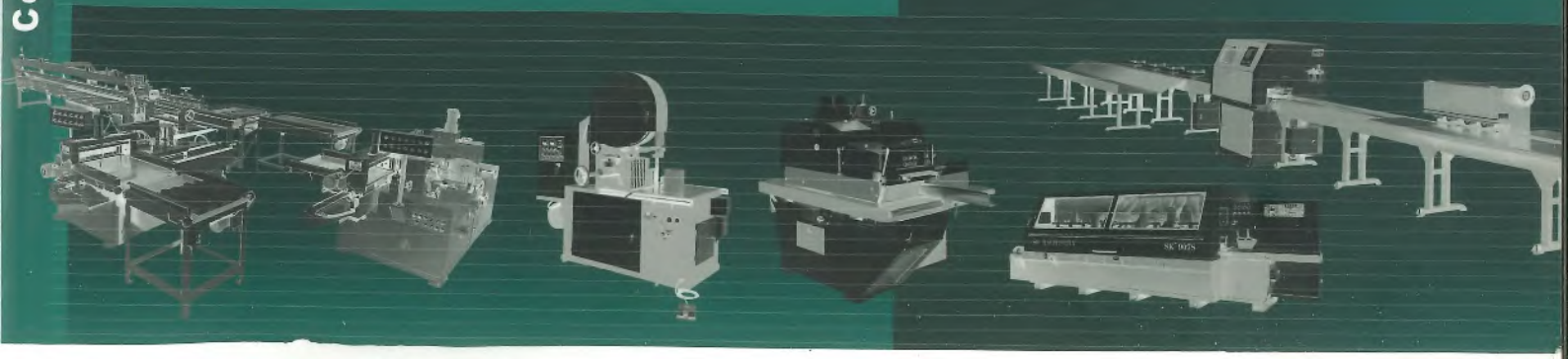

台灣木工機械經典系列

不管生化科技或電腦產業如何發達，但始終無法全面取代木製產品。未來木製品及木製家具會更搶手，且成為高檔的民生用品；其中板類素材可再利用，素有「環保家具」之稱，非常符合綠色地球的要求，家具產業可謂潛力無限。

佔全球第三大出口量的台灣木工機械廠家，數十年來努力研究精進品質。不少廠家並與歐洲、日本先進廠家交流合作，品質備受業界肯定；再加上台灣廠家交貨迅速、配合度高、價格實惠，出口量不但位居亞洲之冠，在美洲、歐洲、非洲亦不遑多讓，再度打亮了MADE IN TAIWAN的招牌。

台灣木工機械產品齊全多樣，為家具業者提供完整、成套的整廠設備，從廠房、機械的規劃、設計、機械採購、安裝到訓練，一應俱全，為家具業者的好幫手。

本書網羅了台灣優良的木工機械產品、系統規劃各類機械及配件，讀者可循目錄索引，很快找到所需產品，如尚有不完善、或不完整之處，敬請指導。

Classic Taiwan Woodworking Machinery Series.

Without regard to how popular or prosperous the various technological products, biotechnology or computer industry products become, products made from wood will never be replaced in the long run. The consumer's perception of products manufactured from wood can be either one of economy or a perception of exceptional value. Consequently, in the future most wooden products and wooden furniture will always be considered as high quality-value added luxury items of timeless value that truly enrich one's life. Also, among the materials used, some wood laminates and board types that can be recycled are deemed 'environmentally friendly furniture' and quite contributory to the greening of the planet earth. Therefore, the potential of the furniture industry is virtually unlimited!

Taiwan woodworking machinery fits in the prestigious category of being the 3rd largest machine export quantity in the world. Taiwan has struggled on research and development for precise quality for the past 10 years. Many local manufacturers have cooperated successfully with partners in Europe and Japan to improve machinery quality and meet or exceed these partners' expectations. Moreover, the Taiwan's companies rapid response, quick product delivery and outstandingly high level of cooperation coupled with reasonable pricing has promoted many Taiwan manufacturers to be the best exporters in Asia.

Even in the North American, European and African marketplaces, you will find many Taiwan woodworking manufacturers have established their own brand (or manufacture products under a proprietary customer's brand name) so that truly "Made in Taiwan" denotes meaningful quality identification.

Taiwan manufacturers possess the knowledge and communication skill to provide a complete factory layout and actual factory machinery plan, design to fully integrate the various machines necessary to completely manufacture your goods. This fully integrated machine proposal extends beyond purchasing and accurate shipment to on-site assembly, installation, machine function training and continued customer service.

The content of this book includes various superior Taiwan woodworking machinery with some basic or rudimentary system plans for these various machines and accessories. If you utilize the index, you can more quickly and easily locate the specific machine that you want. Of course, if you encounter any difficulty or if you have any question, we would enjoy hearing from you. Please do not hesitate to contact us!



目次 INDEX

鋸木機	Saws	1-5
刨木機	Planers	6-10
拼板機	Rotary Composer	11-14
指接機	Finger Jointer	15-16
鉋花機 /立軸機	Routers / Spindle Shaper	17-20
仿型機	Copy Shaper	21
作榫機	Tenoners	22-26
背刀車床	Wood Lathe	27-30
砂光機	Sanding Machine	31-39
裁板機	Panel Saw	40
鑽孔機	Boring Machine	41-45
貼邊機	Banding Machine	46-47
磨刀機	Grinder	48-49
集塵機	Dust Collector	50
集塵設備 /乾燥機	Dust Collecting Equipment / Dryer	51
塗裝設備	Coating Equipment	52-53
油壓曲木機	HYD. Presses for Curved Forming Machine	54
配件類	Accessories	55-57

鋸木機 SAWS

單頭橫式改料帶鋸機

SM-750

Single Head Horizontal Band Resaw

最大工作尺寸 Max. workpiece sizes	280×280mm
最低鋸片至輸送台距離 Distance from lower blade to conveyor table	3-200mm
輸送帶寬度 Width of conveyor belt	280mm
送料速度 Feed speed	0-22mm
鋸輪直徑 Saw wheel diameter	750mm
淨重 Net weight	1400kgs
包裝尺寸 Packing dimensions(1)	2300×1520×2100mm
鋸片規格 Sawblade specif.(L-W-T)	4800×25-38×0.89mm
鋸輪馬達 Saw wheel motor	20HP
油壓系統馬達 Hydraulic system motor	4P / 2HP
油壓 Hydraulic pressure	45kg/cm ²
集塵罩出口直徑 Dust hood outlet dia	100mm
毛重 Gross weight	1800kgs
包裝尺寸 Packing dimensions(2)	2800×680×850mm

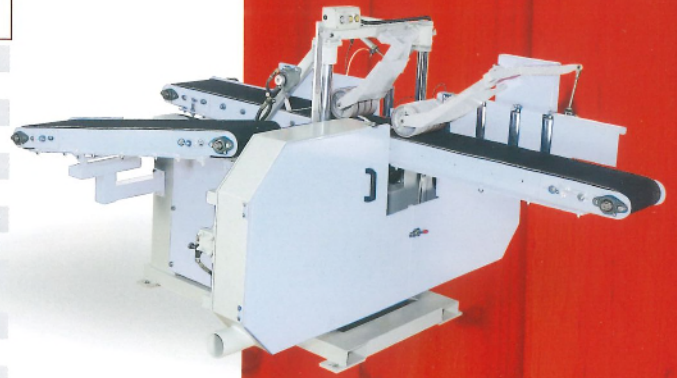

重型帶鋸機

SM-900

Vertical Band Resaw

最大鋸切尺寸 Cutting capacity	550×550mm
最小鋸切厚度 Min. cutting thickness	3mm
隔板至鋸片距離 Distance from fence to blade	230mm
送料滾筒至鋸片距離 Distance from feed roller to blade	320mm
鋸輪直徑 Wheel diameter	36"
鋸輪寬度 Wheel width	3-1/2"
鋸片寬度 Width of blade	4"
鋸片長度 Length of blade	5760mm
送料速度(無段) Feed speed (variable)	0-37M/min
驅動馬達 Wheel drive motor	30HP
淨重/毛重 N.W. / G.W.	2000 / 2200kgs
包裝尺寸 Packing dimensions	273×142×255cm



帶鋸機 Band Resaw

	SK-24	SK-28
鋸輪直徑 Wheel diameter	600mm	700mm
鋸輪寬度 Wheel width	35mm	40mm
最大鋸切尺寸 Cutting capacity	380×580mm	460×680mm
鋸片長度 Length of saw blade	4420-4460mm	5120-5160mm
工作台尺寸 Working table dimension	810×580mm	1000×700mm
驅動馬達 Wheel drive motor	3HP	5HP
飛輪速度 Fly Wheel speed	650R.P.M.	600R.P.M.
淨重 Net weight	380kgs	515kgs
毛重 Gross weight	450kgs	605kgs
包裝尺寸 Packing Dimensions	L100×W66×H206cm	L127×W75×H228cm



單片機

SM-303

Heavy Duty Straight Line Rip Saw

最大加工厚度 Maximum working thickness	85mm
鋸片直徑 Sawblade diameter	200-303mm
鋸片至機身距離 Distance from blade to arm	400mm
工作台面尺寸 Table surface area	1310×780mm
送料速度(3段) Feed speed (3 speeds)	15/20/25M/min
主軸直徑 Saw arbor diameter	Ø25.4mm
主軸馬達 Saw arbor motor	7 1/2 HP(10HP optional)
送料馬達 Feed motor	1HP
鋸片轉速 Saw arbor speed	4200R.P.M.
集塵罩出口直徑 Dust exhaust outlet diameter	Ø4"
履帶寬度 Width of chain block	130mm
淨重/毛重 N.W. / G.W.	900 / 1050kgs
機械尺寸 Machine dimensions	1450×1020×1338mm
裝箱尺寸 Packing dimensions	1500×1170×1500mm





單片機 Straight Line Rip Saw



	SK-355	SK-355H	SK-457H
最大鋸片直徑 Max. sawblade diameter	355mm(14")	355mm(14")	457mm(18")
最大樹幹厚度 Max. stock thickness	75mm(3")	75mm(3")	125mm(5")
主軸直徑 Spindle diameter	50.8mm(2")	50.8mm(2")	50.8mm(2")
主軸馬達 Spindle motor	10HP(7.5kw)	15HP(12kw)	20HP(15kw)
送料馬達 Feed motor	1HP	2HP	2HP
送料速度 Feed speed	10-30MPM(33-99FPM)	10-30MPM(33-99FPM)	10-30MPM(33-99FPM)
主軸制動器 Spindle brake	標準 Standard	標準 Standard	標準 Standard
鋸軸高度 Saw spindle height	可調式 Adjustable	可調式 Adjustable	可調式 Adjustable
自動潤滑器 Automatic lubricator	標準 Standard	標準 Standard	標準 Standard
主軸 Spindle	3450R.P.M.	3450R.P.M.	3450R.P.M.
壓力滾輪數 Pressure roller No.	6	8	8
右鋸片工作台寬 Width of table at right of sawblade	445mm(17 1/2")	445mm(17 1/2")	590mm(23")
左鋸片工作台寬 Width of table at left of sawblade	405mm(16")	455mm(18")	425mm(17")
鋸片至機台寬 Width of sawblade to machine body	460mm(18")	460mm(18")	660mm(26")
機械尺寸 Machine dimension	1750×1570×1530mm	2240×1620×1620mm	2400×1700×1680mm
包裝尺寸 Packing dimension	1770×1670×1670mm	2260×1720×1720mm	2420×1800×1800mm
淨重/毛重 N.W. / G.W.	980 / 1280kgs	1750 / 2150kgs	2000 / 2500kgs



多片鋸 SM-320 Multiple Rip Saw

鋸切厚度 Cutting thickness	10-130mm
最大鋸切寬度 Max. cutting width	320mm
最大進料寬度 Max. infeed width	760mm
最短鋸切長度 Min. length of cut	600mm
送料速度(無段變速) Feed speed (Variable)	9-36M/min.
輸送帶寬度 Feed track width	335mm
鋸片鍵槽 Sawblade keyways	20mm(W)×2
鍵槽距離 Distance between Keyways	80mm
鋸片直徑 Sawblade diameter	Ø255, Ø305, Ø355, Ø405
加工厚度 Cutting thickness	10-50, 10-80, 10-105, 10-130mm
鋸軸直徑 Sawblade spindle diameter	55mm
套筒直徑(鋸片孔徑) Sleeve diameter(Sawblade bore diameter)	70mm
間隔套內/外徑 Spacing collar diameter	70mm/95mm
鋸軸轉速 Spindle speed	3200R.P.M.
鋸片驅動馬達 Saw drive motor	30HP, 50HP, 60HP, 75HP, 100HP
送料馬達 Feed motor	2HP, 3HP
鋸片昇降馬達 Head elevation motor	1/4HP
集屑罩徑 Dust hood outlet diameter	125mm(5")×2
工作台面積 Table area	1800×900mm
工作檯離地高度 Table height from floor	850mm
機械尺寸 Machine dimensions	2450×1500×1800mm
裝箱尺寸 Packing dimensions	2200×1700×1900mm
淨重/毛重 N.W. / G.W.	2450 / 2850kgs

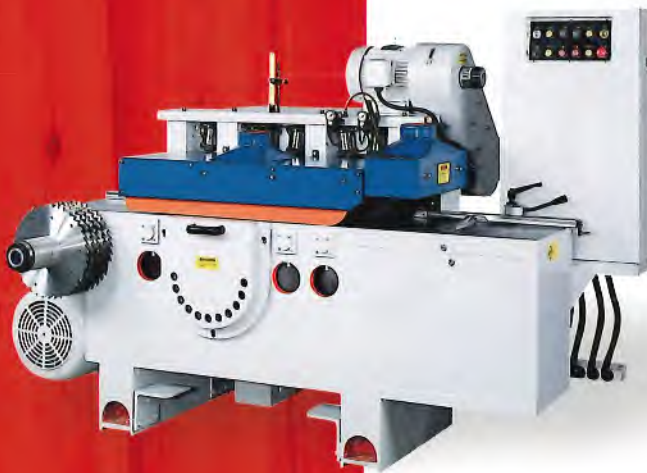

多片鋸 SK-300 Multiple Rip Saw



加工物 Max. working width & thickness	300×100mm
使用圓鋸 Max. saw dia.	Ø355, Ø405mm(option)
主軸直徑(雙鍵) Spindle dia./key groove	Ø70/20mm
送料速度(無段) Variable feeding speed	7-20M/min
主軸迴轉速 Spindle speed	3600R.P.M.
最短加工物 Min. working length	230mm
主軸馬達 Spindle motor	30, 40, 50, 75, 100HP
送料馬達 Feeding motor	2HP
送材昇降馬達 Elevation motor	1/4HP
主軸昇降馬達 Hoist motor	1/4HP
淨重 / 毛重 N.W. / G.W.	1200 / 1400kgs
機械尺寸 Machine size	2300×1250×1500mm
包裝尺寸 Packing size	2450×1350×1650mm



選料機 SM-350 Auto Cut-Off Saw

工作厚度 Cutting thickness	100mm
主軸馬力 Main shaft motor	10HP
送料馬力 Feeder motor(Serve)	400W
送料速度 Feeder speed(Serve)	10-60M/min
主鋸片尺寸 Main sawblade size	Ø455×3.4×Ø1"
主鋸片轉速 Main sawblade	3700R.P.M.
標準氣壓 Standard air pressure	6-8kg/cm ²

*本公司隨時進行研發改進工作，因此本型錄內容規格得以變更，不另行通知。
To ensure technological excellence, specifications are subject to change without prior notice.

雙端圓鋸機

SM-422R Double Ended Circular Sawing Machine

加工長度 Processing length	250-1220mm
加工寬度 Processing width	610mm
圓鋸片(特別附件) Circular sawing blade(special accessories)	305mm
圓鋸片傾斜角度 Inclined angle of circular sawing blade	45°
圓鋸片轉速 Turning speed of circular sawing blade	3300-3650R.P.M., 50-60Hz
軌道數目 No. of rails	1set
圓鋸片驅動馬達 Motor of circular sawing blade	2HP×2
淨重/毛重 N.W. / G.W.	550 / 670kgs
機械尺寸 Machine size	2000×1150×1085mm
裝箱尺寸 Packing size	1880×820×1425mm

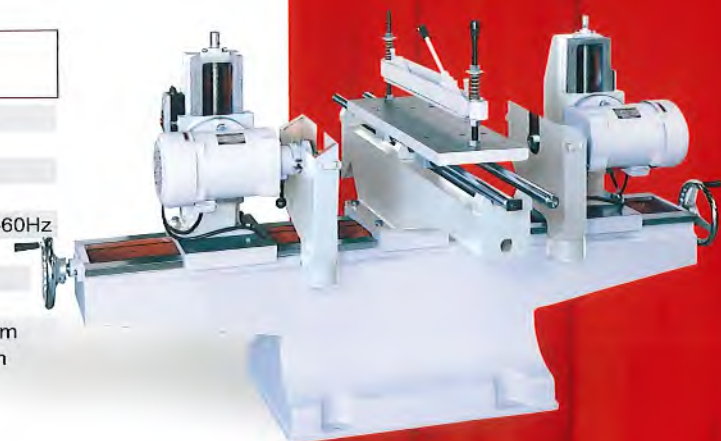

萬能傾軸圓鋸機

TAS-350 Tilting Arbor Saw

鋸片直徑 Diameter saw blade	350mm
最大切斷高度(90°) Max. depth of cut at 90°	125mm
最大切斷高度(45°) Max. depth of cut at 45°	88mm
鋸片直徑 Arbor diameter	30m/m
主軸轉速 Arbor speed	3750R.P.M.
工作檯尺寸 Table size	1220×965mm
工作檯高度 Table height	857mm
Sliding table capacity	1220×2440mm
Max. rip to right at blade	1245mm
馬達 Motor	7 1/2HP
淨重/毛重 N.W. / G.W.	385 / 460kgs
包裝尺寸 Packing size	37"×44"×42"



軸傾斜圓鋸機

SM-551 Tilting Arbor Table Saw

工作檯尺寸 Table size	864×787mm
軸鋸長度 Dia. of arbor spindle diameter	25.4mm
鋸片直徑(特別附件) Dia. of saw blade (Option)	356mm
最大切斷高度(90°) Max. depth of cut at 90°	110mm
最大切斷高度(45°) Max. depth of cut at 45°	80mm
鋸片傾斜 Blade tilt	45°
鋸片轉速 Blade speed	4000R.P.M.
馬達 Motor	3HP(5HP optional)
機械尺寸 Machine size	40"×35"×36"
淨重/毛重 N.W. / G.W.	400 / 450kgs



懸臂吊鋸機

SM-888 Radial Arm Saw

馬達 Motor	4.5HP
馬達轉速 Motor speed	2900R.P.M.
Bearings for rails	8pcs
Spindle bore	Ø25.4mm
鋸片直徑 Blade diameter	305mm
旋轉角度 Head swiveling	0-180°
傾斜角度 Head tilting	0-90°
最大裁切寬度 Max. trimming width	860mm
最大裁切長度 Max. cross cutting length	620mm
工作檯尺寸 Table area	900×1100mm
機械尺寸 Machine size	1120×1100×1170mm
包裝尺寸 Packing size	1150×970×790mm
淨重/毛重 N.W. / G.W.	200 / 240kgs



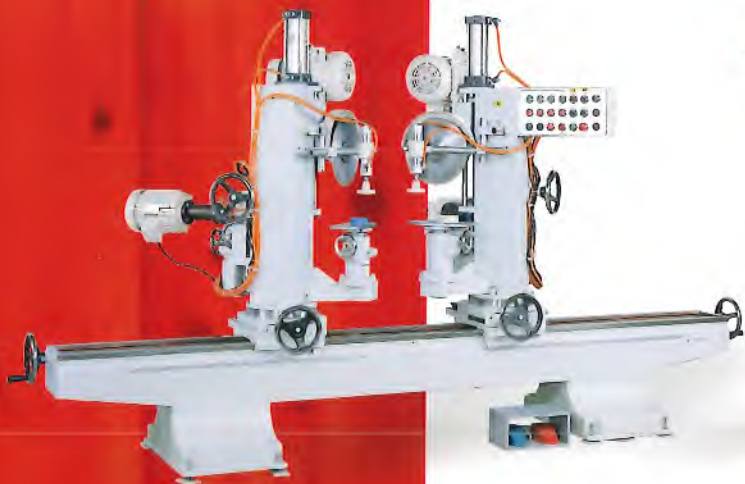

SM-620SA 45° Double End Miter Saw with Boring Head Machine

最大加工長度 Max.length of cut	300-1800mm
最小加工長度 Min.length fo cut	300mm
最大加工寬度 Max.width of cut	30-205mm
最大加工厚度 Max.thickness of cut	80mm
鋸片使用直徑(選購) Sawblade dia.(optional)	12"-14"
鋸片驅動馬達及轉速 Sawblade motor & speed	5HP×2, 4500R.P.M.
驅動馬達 Spindle motor	2HP×2 (Boring spindle)
鑽軸驅動馬達及轉速 Spindle speed	2HP×2, 3400R.P.M.
立柱斜度調整 Column swivel angle	0° -45°
鋸片行程(汽缸驅動) Sawblade stroke	250mm
包裝尺寸 Packing dimensions	2800×90×1500mm
淨重 Net weight	1120kg
毛重 Gross weight	1170kg



SM-426LA Automatic Double End Miter Saw with Moulding Head Machine

軌道數 Number of rails	2
加工寬度 Width of cut	280-1200mm
加工長度 Length of cut	540mm
鋸片使用直徑(選購) Sawblade dia.(optional)	10"-12"(Ø25.4mm)
鋸片驅動馬達 Sawblade motor	2HP×4,3HP×2
立軸直徑 Moiding spindle dia.	25.4 or 30mm
裝刀長度 Length of cutter	80 or 100mm
立軸驅動馬達及轉速 Moiding spindle motor and speed	3HP×2, 7000R.P.M.
鋸片轉速 Sawblade speed	3300-3600R.P.M., 50HZ / 60HZ
鋸片與雙立軸傾斜度 Sawblade and moiding spindle tilt	360°
包裝尺寸 Packing dimensions	2300×1100×1600mm
淨重 Net weight	1000kgs
毛重 Gross weight	1170kgs

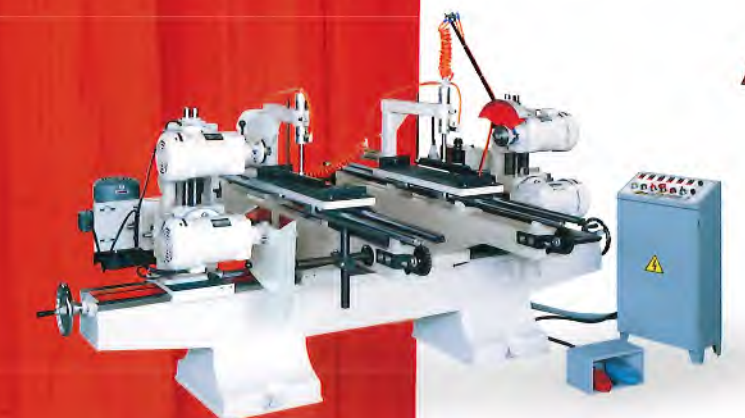

SM-626ART Double Ended Upper & Lower Circular Sawing with Vertical Shaft Machine

加工長度 Processing length	500-1830mm
加工寬度 Processing width	610mm
圓鋸片(特別附件) Circular sawing blade(special accessories)	305mm
圓鋸片轉速 Turning speed of ciecular sawing blade	3300-3650R.P.M., 50-60Hz
軌道數目 No. of rails	2sets
圓鋸片驅動馬達 Motor of circular sawing blade	2HP×4
立軸馬達 Motor of vertical shaft	3HP×2
立軸直徑 Diameter of vertical shaft	Ø30mm, Ø1", Ø1 1/4"
立軸轉速 Turning speed of vertical shaft	6600-7200R.P.M.,50-60Hz
淨重/毛重 N.W. / G.W.	1070 / 1270kgs
機械尺寸 Machine size	2780×1780×1200mm
裝箱尺寸 Packing size	2970×1150×1425mm



SM-424AR Twin Head Circular Saw with Shaper

加工長度 Processing length	250-1220mm
加工寬度 Processing width	610mm
圓鋸片(特別附件) Circular sawing blade	305mm (12")
圓鋸片傾斜度 Inclined angle of circularsawing blade	45°
圓鋸片轉速 Turning speed of circular sawing blade	3300-3650R.P.M., 50-60 Hz
軌道數目 No. of rails	1 set
圓鋸片驅動馬達 Motor of circular sawing blade	2HP×2
立軸馬達 Motor of vertical shaft	3HP×2
立軸直徑 Diameter of vertical shaft	Ø30mm (Standard specification), Ø1", Ø1 1/4" (Special specification)
立軸轉速 Turning speed of vertical shaft	6600-7200R.P.M., 50-60 Hz
淨/毛重 N.W. / G.W.	700 / 850kg
機械尺寸 Machine size	2000×1780×1200mm
裝箱尺寸 Packing size	2060×880×1425mm

SM-18**高速木材切斷機
Cut-Off Saw**

鋸軸轉速 Revolution saw arbor	3320 / 3180R.P.M.
使用圓鋸 Saw blade	1"×18"×3.4mm×120T
驅動馬力 Driving motor	5HP-7 1/2HP
定盤尺寸 Table dimension	670×710mm
定盤離地高度 Level height of table	840mm
所需空壓 Air required	4kg/cm ²
裝箱尺寸 Packing size	870×910×1270mm
淨重/毛重 N.W. / G.W.	360 / 420kgs

**SM-550****萬能圓鋸機
Universal Circular Saw**

使用鋸片 Sax size	356mm
最大鋸切厚度 Max. cutting thickness	85mm
主軸直徑 Spindle diameter	25.4mm
主軸轉速 Spindle speed	3000 / 4500R.P.M.
工作台尺寸 Table size	830×750mm
工作台最大傾斜 Max. table tilting angle	45°
工作馬達 Working size	3HP
機械尺寸 Machine size	1160×950×890mm
淨重/毛重 N.W. / G.W.	195 / 255kgs

**SM-280****線鋸機
Jig Saw Specialist**

切削中心離機身面距離 Throat depth	650mm
加工厚度 Max. thickness of cut	100mm
定盤面積 Table surface size	485×500mm
鋸線長度 Jig sawblade length	310mm
離合器剎車馬達 Motor	1HP
迴轉速度 Speed	1500
淨重/毛重 N.W. / G.W.	280 / 360kgs
機械尺寸 Machine dimensions	1050×650×1230mm
包裝尺寸 Packing dimensions	1125×725×1370mm

**SM-150****自動多片框鋸機
Frame Saw**

馬達 Motor	0+1/4+5HP(server)
最大加工厚度 Max. working thickness	200mm
最小加工厚度 Min. working thickness	60mm
最大加工寬度 Max. working width	150mm
最小加工長度 Min. working length	400mm
進料速度 Feeding speed	0.5-2.0M/min
鋸片轉速 Sawblade speed	450R.P.M.
Sawblade spec.	505×40×1.0mm(body)
Min. finished product thickness	1.5mm
Saw kerf	1.2-1.6mm
機械尺寸 Machine dimensions	3300×950×1780mm
包裝尺寸 Packing dimensions	3400×1000×1800mm
淨重/毛重 N.W. / G.W.	3200 / 3300 kgs

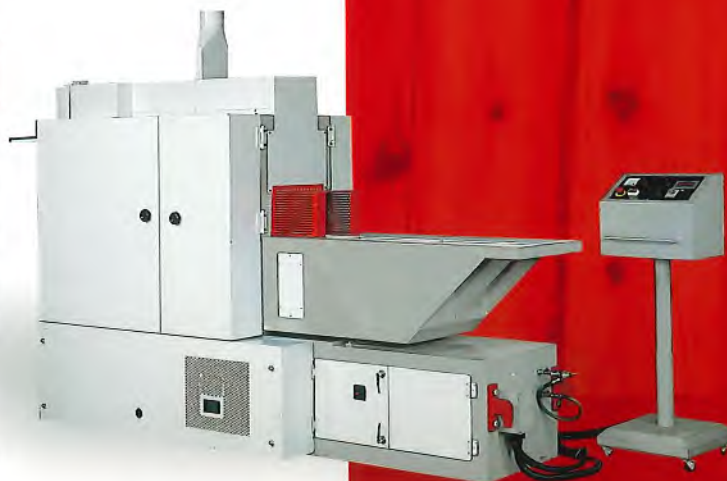

PLANER 刨木機



SK-907S 四面七軸刨木機
4-Side 7-Spindle Moulder



刨木容量 <i>Moulding capacity</i>	
寬度 <i>Width</i>	15-230mm
厚度 <i>Thickness</i>	10-125mm
最小工作長度 <i>Min. length of workpiece</i>	250mm
切割軸徑 <i>Cutting circles</i>	
第一下軸 <i>First bottom spindle</i>	Ø100-160mm
其他 <i>All other</i>	Ø100-200mm
主軸直徑 <i>Spindle diameter</i>	Ø40mm
主軸速度 <i>Spindle speed</i>	6000R.P.M.
基本馬達尺寸 <i>Basic motor size</i>	
水平軸 <i>Each horizontal spindle</i>	7.5HP
垂直軸 <i>Each vertical spindle</i>	7.5HP
第一上軸 <i>First top spindle</i>	10HP
送料驅動 <i>Feed drive</i>	7.5HP
送料速度 <i>Feed speed</i>	6-24M/min
送料滾輪 <i>Feed roller</i>	
Dia. × I.D.	Ø140 × 35mm
壓力 <i>Pressure</i>	6 bar
送料台長度 <i>Length of infeed table</i>	2000mm
機械尺寸 <i>Machine dimension</i>	5100 × 2000 × 2000mm
包裝尺寸 <i>Packing dimension</i>	5300 × 2100 × 2100mm
淨重/毛重 <i>N.W. / G.W.</i>	6000 / 6700kgs



SK-909US 四面九軸刨木機
4-Side 9-Spindle Moulder



刨木容量 <i>Moulding capacity</i>	
寬度 <i>Width</i>	15-230mm
厚度 <i>Thickness</i>	10-125mm
最小工作長度 <i>Min. length of workpiece</i>	250mm
切割軸徑 <i>Cutting circles</i>	
第一下軸 <i>First bottom spindle</i>	Ø100-160mm
其他 <i>All other</i>	Ø100-200mm
主軸直徑 <i>Spindle diameter</i>	Ø40mm
主軸速度 <i>Spindle speed</i>	6000R.P.M.
基本馬達尺寸 <i>Basic motor size</i>	
水平軸 <i>Each horizontal spindle</i>	7.5HP
垂直軸 <i>Each vertical spindle</i>	7.5HP
第一上軸 <i>First top spindle</i>	10HP
送料驅動 <i>Feed drive</i>	7.5HP
送料速度 <i>Feed speed</i>	6-24M/min
送料滾輪 <i>Feed roller</i>	
Dia. × I.D.	Ø140 × 35mm
壓力 <i>Pressure</i>	6 bar
送料台長度 <i>Length of infeed table</i>	2000mm
機械尺寸 <i>Machine dimension</i>	6200 × 2000 × 2000mm
包裝尺寸 <i>Packing dimension</i>	6400 × 2100 × 2100mm
淨重/毛重 <i>N.W. / G.W.</i>	7200 / 8000kgs

雙面刨木機
2-Side Planer



SK-224

最大刨木寬度 Maximum plane width	600mm
最大刨木厚度 Maximum plane thickness	125mm
最大刨木長度 Maximum plane length	300mm
主軸速度 Spindle speed	4000R.P.M.
送料速度 Feed speeds	7-21M/min, 23-69F/min
工作台尺寸 Table surface size	2740×690mm
4×刀片尺寸 Knife size	600×6×38mm
馬達 Motor	
下軸 Bottom spindle	10HP
上軸 Top spindle	15HP
送料 Feeding	3HP
昇高 Elevation	1/2HP
集塵罩出口尺寸 Dust hood outlet size	125mm
機械尺寸 Machine dimension	2740×1320×1540mm
包裝尺寸 Packing dimension	2900×1500×1800mm
淨重 Net weight	3200kgs
毛重 Gross weight	3650kgs



雙面刨木機

PM-650D 2-Side Planer

最大刨削寬度 Max. width of planing	650mm
最大刨削厚度 Max. thickness of planing	200mm
最短刨削長度 Min. length of planing	385mm
下軸轉速 Bottom spindle speed	5800R.P.M.
上軸轉速 Top spindle speed	5800R.P.M.
送料速度(無段變速) Feed speed(Variable)	7.5-30M/min(50HZ), 9-36M/min(60HZ)
下軸驅動馬達 Bottom spindle drive motor	20HP(40HP選購)
上軸驅動馬達 Top spindle drive motor	30HP(50HP選購)
送料馬達 Feed drive motor	5HP
壓料輪昇降馬達 Pressure roller elevation motor	1 1/2HP
集屑罩徑 Dust Hood outlet dimensions	Ø150mm(6")×2
氣壓壓力 Air pressure	5-6kg/cm ²
工作台離地高度 Table height from floor	890mm
機械尺寸 Machine dimensions	2435×1550×1965mm
裝箱尺寸 Packing dimensions	2300×1850×2100mm
機械重量 Net weight	3000kgs
裝箱重量 Gross weight	3500kgs

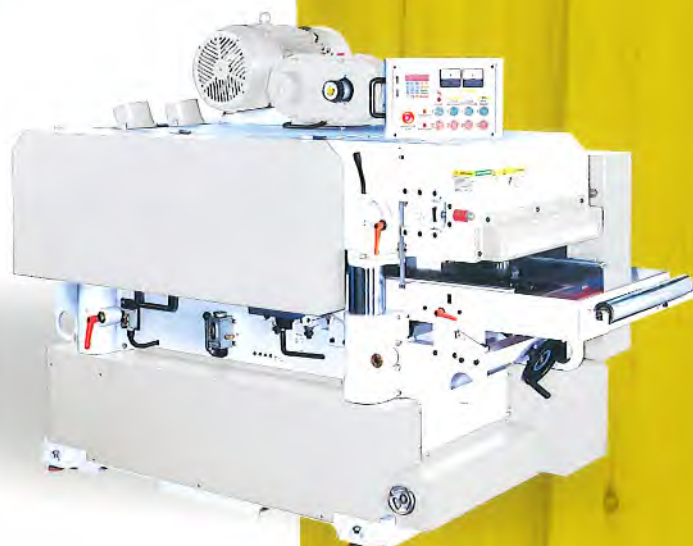

開邊式自動三面刨木機

PM-403 Open Side 3-Side Moulder

最大刨削寬度 Max. width of planing	100mm
最大刨削厚度 Max. thickness of planing	75mm
上軸馬達 Spindle motor(Upper)	5HP
立軸馬達 Spindle motor(Vert)	3HP×2
送料馬達 Feed motor	1HP
最小刨木寬度 Min. Planing width	25mm
最小刨木長度 Min. Planing length	300mm
上軸直徑 Spindle diameter(Upper)	Ø31.75mm
立軸直徑 Spindle diameter(Vert)	Ø25.4mm
上軸速度 Spindle speed(Upper)	7200R.P.M.
立軸速度 Spindle speed(Vert)	7500R.P.M.
上刀片尺寸 Cutter size(Upper)	Ø100×100L
立刀片尺寸 Cutter size(Vert)	Ø100×70L
集塵罩直徑 Dust outlet diameter	Ø100mm
送料速度 Feed speeds	2.5-15M/min(無段變速 Variable)
送料台長度 Infeeding table length	1020mm
裝箱尺寸 Packing dimensions	1490×1210×1400mm
機械重量 Net weight	650kgs
裝箱重量 Gross weight	700kgs





選料機 SM-230 Auto Optimizer

加工厚度 Cutting thickness	8-80mm
加工寬度 Cutting width	25-230mm
最小裁切長度 Min. length of cut	25mm
送料速度(無段變速) Feed speed (Variable)	0-200M/min
切段速度 Cut of speed	0.6-1sec
鋸片直徑 Sawblade diameter	Ø505mm (20")
鋸片孔徑 Saw arbor diameter	Ø25.4mm(1")
鋸片轉速 Spindle speed	3800R.P.M.
入料馬達 Infeed motor	2HP
送料伺服馬達 Feeding servo motor	7.5kw
鋸片驅動馬達 Saw drive motor	10HP
分料馬達 Outfeed motor	1HP 1/2HP
氣壓壓力 Air pressure	4-6 kg/cm ²
集屑罩徑 Dust hood outlet diameter	Ø125mm(5") × 1
前送料台尺寸 Front feed conveyor dimensions	6276 × 1180 × 1270mm
分送料台尺寸 Rear feed conveyor dimensions	7146 × 1725 × 900mm
機械尺寸 Machine dimensions	1720 × 1100 × 1550mm
裝箱尺寸 Machine packing dimensions	1850 × 1350 × 1700mm
淨重/毛重 N.W. / G.W.	1500 / 1950kgs



四面四軸鉋木機 KPM-230S 4-Side 4-Spindle Moulder



鉋木容量 Moulding capacity

寬度 Width	15-230mm
厚度 Thickness	10-125mm
最小工作長度 Min. length of workpiece	250mm
切割軸徑 Cutting circles	
第一下軸 First bottom spindle	Ø100-125mm
其他 All other	Ø100-140mm
主軸直徑 Spindle diameter	Ø40mm
主軸速度 Spindle speed	6000R.P.M.
基本馬達尺寸 Basic motor size	
水平軸 Each horizontal spindle	7.5HP
垂直軸 Each vertical spindle	7.5HP
第一上軸 First top spindle	10HP
送料驅動 Feed drive	2HP
送料速度 Feed speed	6-24M/min
送料滾輪 Feed roller	
Dia. × I.D.	Ø140 × 35mm
壓力 Pressure	6bar
送料台長度 Length of infeed table	1500mm
機械尺寸 Machine dimension	3150 × 1900 × 1900mm
包裝尺寸 Packing dimension	3350 × 2000 × 2000mm
淨重/毛重 N.W. / G.W.	2600 / 3000kgs



四面五軸鉋木機 KP5-230E 4-Side 5-Spindle Moulder



鉋木容量 Moulding capacity

寬度 Width	15-230mm
厚度 Thickness	10-125mm
最小工作長度 Min. length of workpiece	250mm
切割軸徑 Cutting circles	
第一下軸 First bottom spindle	Ø100-150mm
其他 All other	Ø100-180mm
主軸直徑 Spindle diameter	Ø40mm
主軸速度 Spindle speed	6000R.P.M.
基本馬達尺寸 Basic motor size	
水平軸 Each horizontal spindle	7.5HP
垂直軸 Each vertical spindle	7.5HP
第一上軸 First top spindle	10HP
送料驅動 Feed drive	5HP
送料速度 Feed speed	6-24M/min
送料滾輪 Feed roller	
Dia. × I.D.	Ø140 × 35mm
壓力 Pressure	6bar
送料台長度 Length of infeed table	1500mm
機械尺寸 Machine dimension	3500 × 1900 × 1900mm
包裝尺寸 Packing dimension	3700 × 2000 × 2000mm
淨重/毛重 N.W. / G.W.	4000 / 4500kgs



四面六軸鉋木機

KP6-230S 4-Side 6-Spindle Moulder



鉋木容量 <i>Moulding capacity</i>	
寬度 Width	15-230mm
厚度 Thickness	10-125mm
最小工作長度 Min. length of workpiece	250mm
切割軸徑 <i>Cutting circles</i>	
第一下軸 First bottom spindle	Ø100-160mm
其他 All other	Ø100-200mm
主軸直徑 Spindle diameter	Ø40mm
主軸速度 Spindle speed	6000R.P.M.
基本馬達尺寸 <i>Basic motor size</i>	
水平軸 Each horizontal spindle	7.5HP
垂直軸 Each vertical spindle	7.5HP
第一上軸 First top spindle	10HP
送料驅動 Feed drive	5HP
送料速度 Feed speed	6-24M/min
送料滾輪 <i>Feed roller</i>	
Dia. × I.D.	Ø140 × 35mm
壓力 Pressure	6 bar
送料台長度 Length of infeed table	1500mm
機械尺寸 Machine dimension	3850 × 2000 × 2000mm
包裝尺寸 Packing dimension	4050 × 2100 × 2100mm
淨重/毛重 N.W. / G.W.	5100 / 5600kgs



四面六軸鉋木機

SK-622 4-Side 6-Spindle Moulder



鉋木容量 <i>Moulding capacity</i>	
寬度 Width	15-220mm
厚度 Thickness	10-125mm
最小工作長度 Min. length of workpiece	250mm
切割軸徑 <i>Cutting circles</i>	
第一下軸 First bottom spindle	Ø100-150mm
其他 All other	Ø100-180mm Except 6th Ø100-200mm
主軸直徑 Spindle diameter	Ø40mm
主軸速度 Spindle speed	6000R.P.M.
基本馬達尺寸 <i>Basic motor size</i>	
水平軸 Each horizontal spindle	7.5HP
垂直軸 Each vertical spindle	7.5HP
第一上軸 First top spindle	10HP
送料驅動 Feed drive	5HP
送料速度 Feed speed	6~24M/min
送料滾輪 <i>Feed roller</i>	
Dia. × I.D.	Ø140 × 35mm
壓力 Pressure	6bar
送料台長度 Length of infeed table	1500mm
機械尺寸 Machine dimension	3970 × 1700 × 1700mm
包裝尺寸 Packing dimension	4170 × 1800 × 1800mm
淨重/毛重 N.W. / G.W.	4000 / 4500kgs

手壓刨木機 Hand Jointer



	PM-A512	PM-A514	PM-A516
工作台面積 Table area	1880×305mm	2032×356mm	2184×406mm
切頭片尺寸 Cutterhead diameter	100mm	100mm	100mm
最大刨木寬度 Max. planing width	305mm	350mm	407mm
最大切割深度 Max. cutting depth	19mm	19mm	19mm
馬達 Motor	3P, 3HP	3P, 5HP	3P, 5HP
切割速度 Speed of cutterhead	5200R.P.M.	5200R.P.M.	5200R.P.M.
淨重 Net weight	410kgs	480kgs	530kgs
毛重 Gross weight	482kgs	552kgs	626kgs
包裝尺寸 Packing size	1981×670×1010mm	2170×710×710mm	2300×775×1070mm
隔板尺寸 Fence size	1055×115mm	1055×115mm	1055×115mm

自動刨木機 Auto Planer



	PM-816B	PM-820B	PM-824B	PM-826B	PM-830B
工作台面積 Table area	710×440mm	710×540mm	810×640mm	840×705mm	915×807mm
切片直徑 Cutterhead dia.	80mm	80mm	80mm	80mm	80mm
切割馬達 Cutterhead motor	3HP	5HP	7.5HP	7.5HP	10HP
切割速度 Cutterhead speed	5400R.P.M.	5400R.P.M.	5400R.P.M.	5200R.P.M.	5200R.P.M.
送料驅動馬達 Feed driven motor	2HP	2HP	2HP	2HP	2HP
刀片數 Number of knives	3	3	3	3	3
送料滾輪 Feed rollers	70mm	70mm	70mm	70mm	70mm×2
工作台滾輪 Table rollers	60mm	60mm	60mm	60mm	60mm
送料速度 Range of feed speed	6-12M/min.	6-12M/min.	6-12M/min.	6-12M/min.	6-12M/min.
最大切割深度 Max. depth of cut	9.5mm	9.5mm	9.5mm	9.5mm	9.5mm
最大刨木寬度 Max. planing width	406mm	508mm	609mm	660mm	762mm
刨木厚度 Planing thickness	3.2-184mm	3.2-184mm	3.2-184mm	3.2-184mm	3.2-184mm
淨重/毛重 N.W. / G.W.	490 / 585kgs	590 / 685kgs	690 / 785kgs	620 / 710kgs	820 / 950kgs
包裝尺寸 Packing size	980×870×1290mm	1070×870×1290mm	1160×980×1330mm	1220×980×1350mm	1340×1150×1350mm

自動刨木機 Auto Planer



	PM-A716S	PM-A720S	PM-A724S
工作台面積 Table area	438×710mm	540×710mm	642×840mm
切頭直徑 Cutterhead diameter	80mm	80mm	80mm
最大刨木寬度 Max. planing width	405mm	508mm	610mm
最大刨木厚度 Max. planing thickness	165mm	165mm	165mm
最小刨木厚度 Min. planing thickness	3mm	3mm	3mm
最大切割深度 Max. cutting depth	6.4mm	6.4mm	6.4mm
刀片數 Knives	3pcs	3pcs	3pcs
切速 Single cutterhead speed	5200R.P.M.	5200R.P.M.	5200R.P.M.
送料速度 Feeding speed	8M/min	8M/min	8M/min
馬達 Motor	3P, 3HP	3P, 3HP	3P, 7 1/2HP
淨重 Net weight	300kg	350kg	450kg
毛重 Gross weight	350kg	405kg	520kg
機械尺寸 Machine size	820×750×1000mm	850×820×1000mm	950×850×1000mm
包裝尺寸 Packing size	900×850×1150mm	990×870×1150mm	1080×890×1150mm

自動刨木機 Auto Planer



	PM-840C	PM-610C	PM-855C
工作台面積 Table area	1400×1090mm	1200×700mm	1400×1090mm
最大工作寬度 Max. working width	1016mm	610mm	1016mm
最大工作深度 Max. cutting depth	9.5mm	12mm	9.5mm
刨木厚度 Planing thickness range	12-170mm	6-250mm	12-170mm
最小工作長度 Min. working length	305mm	305mm	305mm
切頭尺寸 Cutterhead size	Ø127mm×1016mm	Ø127mm×610mm	Ø127mm×1400mm
切頭速度 Cutterhead speed	3600R.P.M.	4200R.P.M.	3600R.P.M.
刀數 Number of knives	6mm×4	6mm×4	6mm×4
送料滾輪 Infeed rollers	102mm×2	102mm×2	102mm×2
工作台滾輪 Table rollers	100mm×3	60mm×3	100mm×3
出口滾輪 Outfeed rollers	102mm	102mm	102mm
送料速度 Range of feed speeds	3-15M/min	3-15M/min	3-15M/min
切割馬達 Cutterhead motor	20HP	10HP	25HP
送料驅動馬達 Feeding driven motor	3HP	2HP	5HP
昇高馬達 Elevating motor	1HP	1/2HP	1HP
機械尺寸 Machine size	1600×1400×1510mm	1190×1000×1420mm	1950×1500×1550mm
包裝尺寸 Packing size	1750×1550×1850mm	1340×1150×1720mm	2100×1550×1900mm
淨重/毛重 N.W. / G.W.	2150 / 2500kgs	1150 / 1370kgs	2950 / 3350kgs

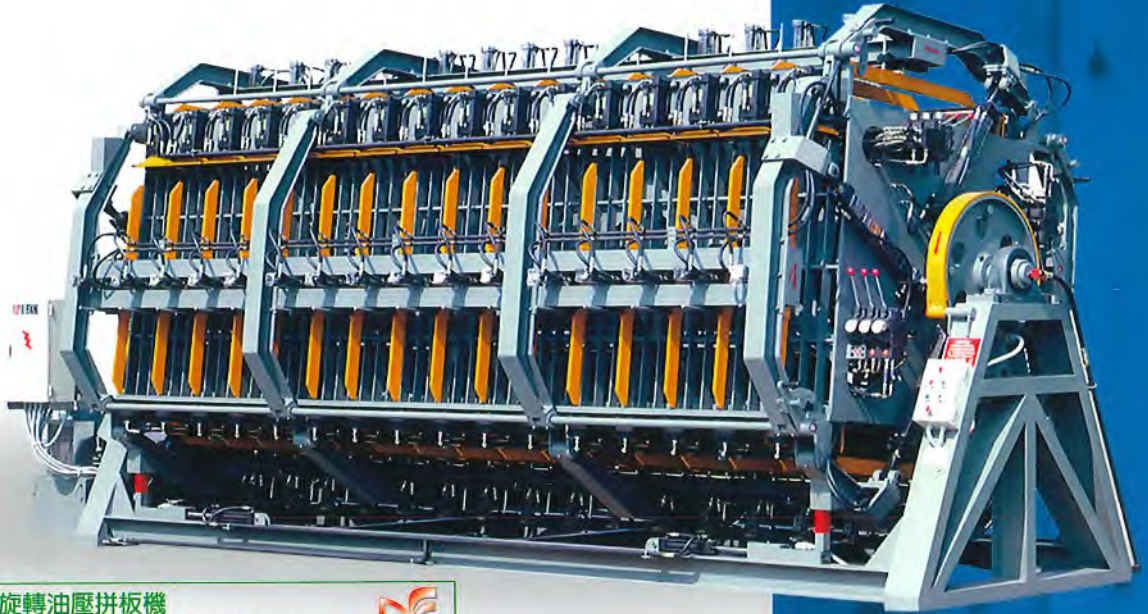

四面旋轉油壓拼板機

4-Fans Rotary Hydraulic Composer



R4-6200-1300

工作尺寸 Working size	6200 × 1300 × 10-150mm
油壓型式 Oil pressure type	
上壓 Up pressure	80Ø × 80 1 side 18 pcs total 72 pcs
中壓 Mid pressure	40Ø × 150 1 side 18 pcs total 72 pcs
側壓 Side pressure	63Ø × 550 1 side 2 pcs total 8 pcs
壓力 Pressure	140kg/cm ²
馬力 Motor	3HP 6P
油壓幫浦 Hydraulic pump	10HP
機械尺寸 Machine dimension	7700 × 2650 × 2900mm
裝箱尺寸 Packing dimension	8030 × 3000 × 3430mm
淨重/毛重 N.W. / G.W.	16500 / 19500kgs

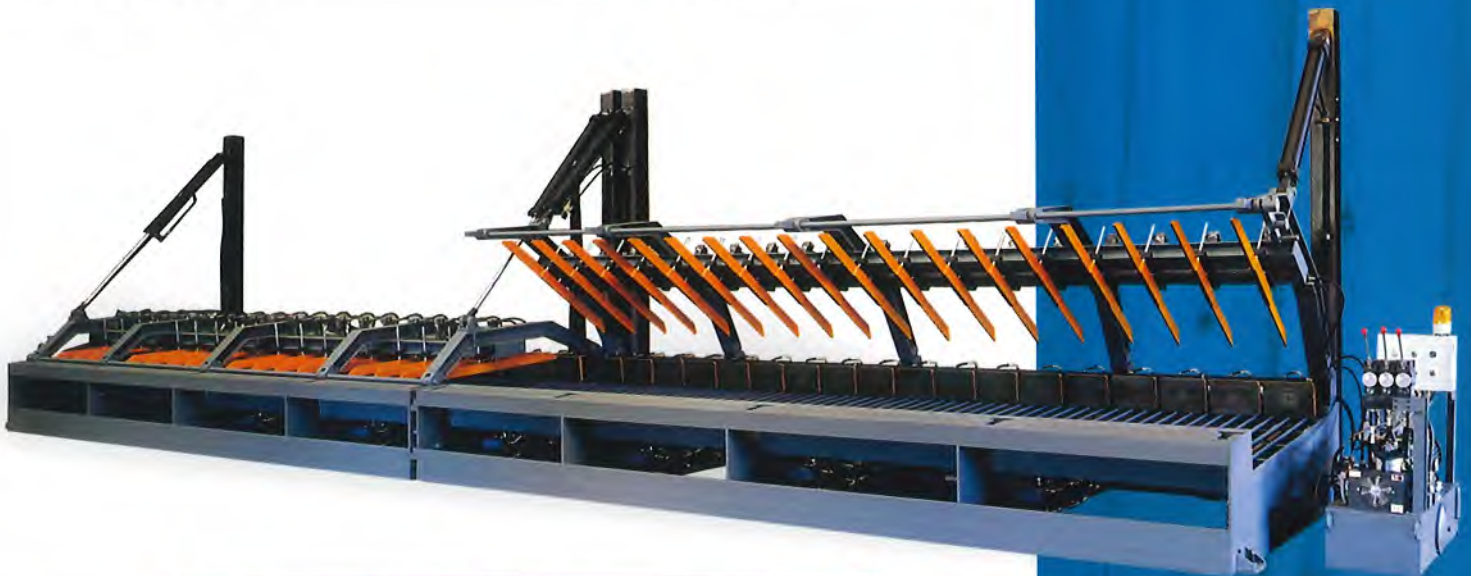

單面臥式油壓式拼板機

Single-Side Horizontal Hydraulic Composer



R1-12000-1300

加工尺寸 Working size	12000 × 1300 × 10-160mm 12000 × 1300 × 50-210mm
油壓型式 Oil pressure type	
上壓 Up pressure	80Ø × 80 共36支
中壓 Mid pressure	40Ø × 150 共36支
側壓 Side pressure	80Ø × 900 共4支
壓力 Pressure	140kg/cm ²
油壓幫浦 Hydraulic pump	7 1/2HP × 2
機械尺寸 Machine dimension	6600 × 2300 × 2500mm
裝箱尺寸 Packing dimension	6600 × 2300 × 2500mm
淨重/毛重 N.W./G.W.	13000 / 13800 kgs

*Connect two machines in one by connection.

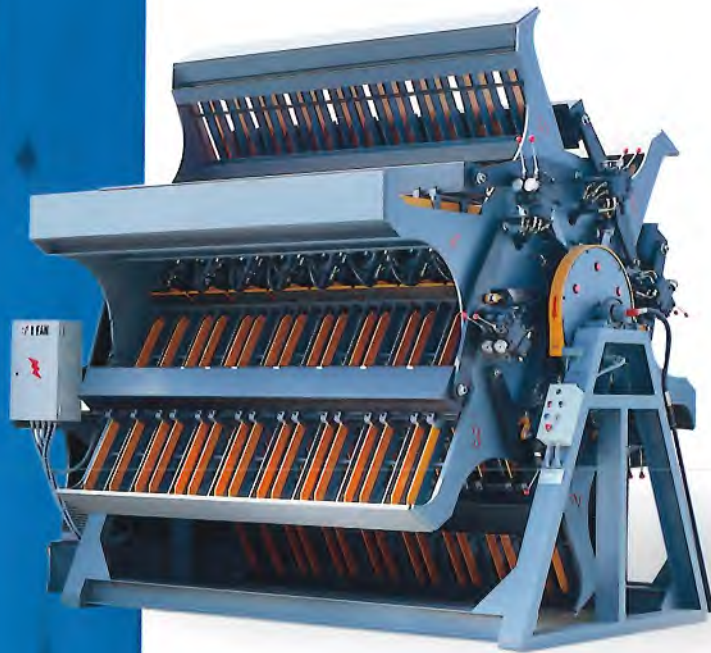

R6-2500-1300

六面旋轉式油壓拼板機
6-Fans Hydraulic Rotary Composer



工作尺寸 Working size	2500 × 1300 × 150mm
油壓型式 Oil pressure type	
上壓 Up pressure	80Ø × 80 1 Side 6 pcs total 36 pcs
側壓 Side pressure	63Ø × 280 1 Side 2 pcs total 12 pcs
壓力 Pressure	140kg/cm ²
馬力 Motor	2HP 6P
油壓幫浦 Hydraulic pump	7 1/2HP
機械尺寸 Machine dimension	3800 × 2900 × 3400mm
裝箱尺寸 Packing dimension	4090 × 3550 × 3697mm
淨重/毛重 N.W. / G.W.	6500 / 7900kgs

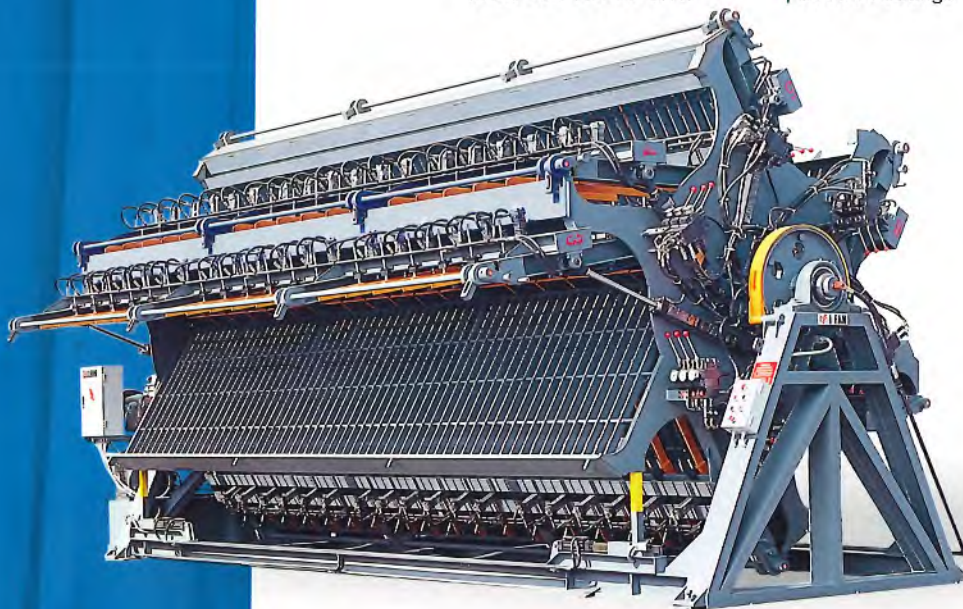

DR6-6200-1300

六面旋轉式油壓式拼板機
6-Fans Hydraulic Rotary Composer



工作尺寸 Working size	6200 × 1300 × 30-120mm
油壓型式 Oil pressure type	
上壓 Up pressure	80Ø × 80 1 Side 18 pcs total 108 pcs
中壓 Mid pressure	40Ø × 150 1 Side 18 pcs total 108 pcs
側壓 Side pressure	63Ø × 550 1 Side 2 pcs total 12 pcs
壓力 Pressure	140kg/cm ²
馬力 Motor	3HP 6P
油壓幫浦 Hydraulic pump	15HP
機械尺寸 Machine dimension	7800 × 3550 × 3750mm
裝箱尺寸 Packing dimension	8150 × 3750 × 4000mm
淨重/毛重 N.W. / G.W.	25000 / 27000kgs



HA2-2500-1300(A) 滑動型雙面油壓式拼板機(重型)  Sliding Double Hydraulic Composer(Heavy Duty)

工作尺寸 Working size	2500 × 1300 × 210mm
油壓型式 Oil pressure type	
上壓 Up pressure	125Ø × 80 1Side 8pcs total 16 pcs
中壓 Mid pressure	40Ø × 150 1Side 4pcs total 8 pcs
滑動座	4組
壓力 Pressure	140kg/cm ²
油壓幫浦 Hydraulic pump	7 1/2HP × 1
機械尺寸 Machine dimension	3600 × 2300 × 2500mm
裝箱尺寸 Packing dimension	3600 × 2300 × 2500mm
淨重/毛重 N.W./G.W.	5500 / 5700kgs

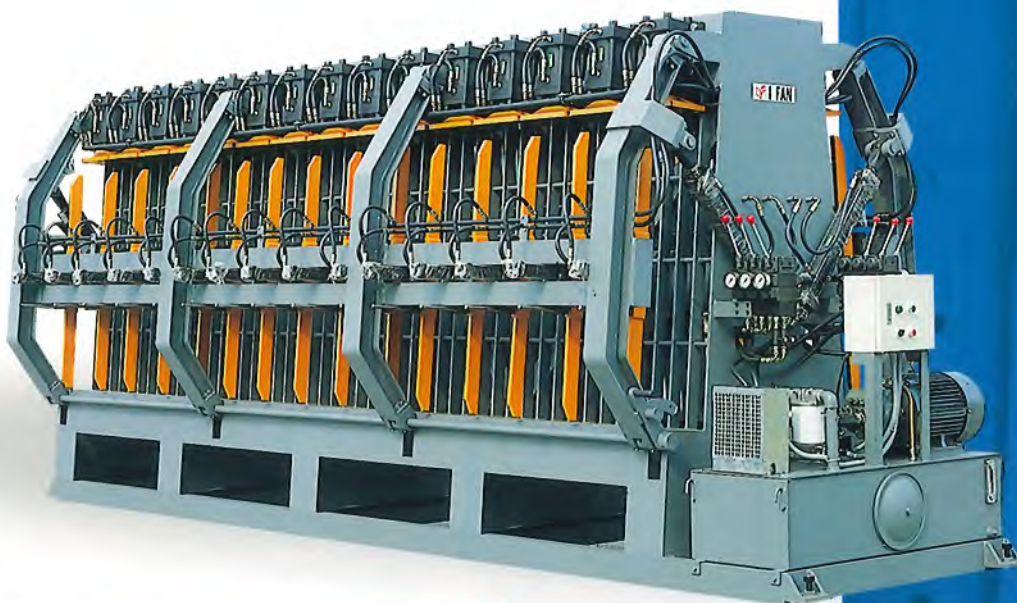

A2-4600-1300 展開型雙面油壓拼板機  Double-Side Spread Hydraulic Composer

工作尺寸 Working size	4600 × 1300 × 150mm
油壓型式 Oil pressure type	
上壓 Up pressure	80Ø × 80 1 Side 13 pcs total 26 pcs
中壓 Mid pressure	40Ø × 150 1 Side 13 pcs total 26 pcs
側壓 Side pressure	63Ø × 550 1 Side 2 pcs total 4 pcs
壓力 Pressure	140kg/cm ²
油壓幫浦 Hydraulic pump	10HP
機械尺寸 Machine dimension	5500 × 2100 × 2300mm
裝箱尺寸 Packing dimension	5800 × 2200 × 2500mm
淨重/毛重 N.W./G.W.	8700 / 9000kgs

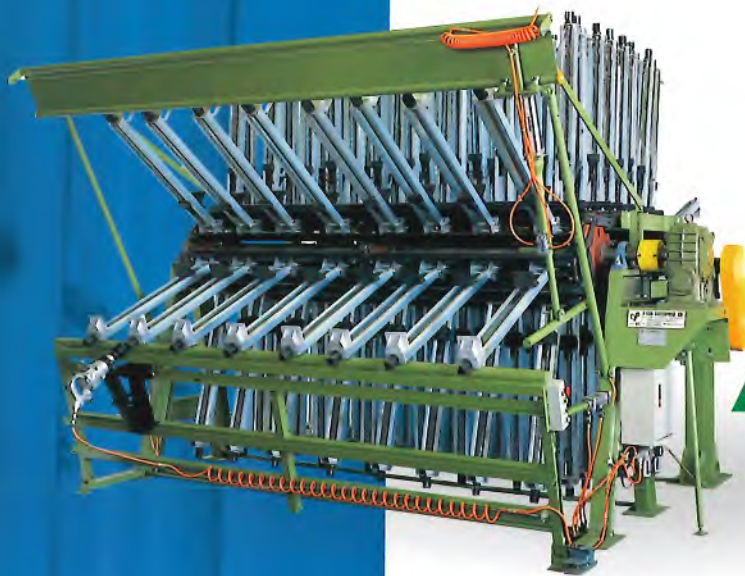

IF 16.20.30 or 40/ SECTIONS

氣壓式/油壓鎖緊式拼板機
Pneumatic/Hydraulic Tightener Clamp Carrier

夾具工作深度 Clamp working depth	30", 38", 44", 50", 52"
工作長度 Working length	103"-180"

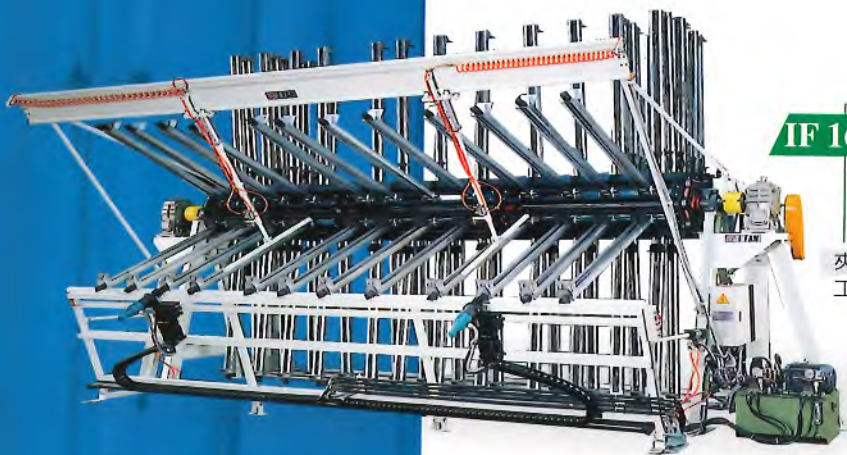

IF 16.20 SECTIONS

雙邊傳動油壓鎖緊式拼板機
Double-Side Transmission Hydraulic Locking
Clamp Carrier

夾具工作深度 Clamp working depth	30", 38", 44", 50", 52"
工作長度 Working length	180"



FE-024, FE-036, FE-048

滾輪式佈膠機 Roller Glue Spreader

工作寬度 Working width	24", 36", 48"
--------------------	---------------



AN-030 自動佈膠機 Auto Glue Spreader

Total length	3m
工作寬度 Working width	420mm



AN-010 小型手動佈膠機 Mini-Size Manual Glue Spreader

加工厚度 Working thickness	250mm
------------------------	-------





指樺成型機 Finger Shaper, 皮帶式 Belt Type

	SK-610B		SK-410B	
	SK-530A3	SK-530A4	SK-530A3	SK-530A4
工作台尺寸 Working table	610×800mm		410×800mm	
工作範圍 長×寬×高 Working Capacity L×W×H	200-800×610×150	200-800×610×150	200-800×410×150	200-800×410×150
馬力入料 Power infeeding	1/4 HP×1 PC	1/4 HP×1 PC	1/4 HP×1 PC	1/4 HP×1 PC
主鋸 Sawing	3 HP×1PC	3 HP×1PC	3 HP×1PC	3 HP×1PC
預切鋸 Linear sawing	1 HP×1PC	1 HP×2PCS	1 HP×1PC	1 HP×2PCS
打樺 Shaping	15 HP×1PC	15 HP×1PC	15 HP×1PC	15 HP×1PC
油壓幫浦 Hydraulic pump	2 HP×1PC	2 HP×1PC	2 HP×1PC	2 HP×1PC
上膠輪 Gluing roll		1/4HP×1PC		1/4HP×1PC
速度 Speed	5 Cycles / 2 min			
機械尺寸 Machine size L×W×H	2866×1323×1480mm	3566×1323×1480mm	2550×1323×1480mm	3270×1323×1480mm
機械淨/毛重 Machine WT. N.W. / G.W.	1300/1550kgs	1450/1750kgs	1200/1550kgs	1400/1700kgs
包裝尺寸 Packing meas L×W×H	2950×1650×1521mm	3670×1650×1521mm	2666×1650×1521mm	3366×1650×1521mm

指樺接合機 Assembly Press

	SK-45AP	SK-45ASP	SK-45CAP
接合長度 Length assembled		4.6 meter.max	
馬力: Power :Sawing	2 HP×1PC	3 HP×1PC	3 HP×1PC
油壓幫浦 Hydraulic pump	5 HP×1PC	5 HP×1PC	5 HP×1PC
送料 Feeding	1/4 HP×1 PC		
速度 Speed	8 meters/min	13 meters/min	27 meters/min
工作範圍 長×寬×高 Working Capacity L×W×H		3000-4600×22-150×18-75mm	
機械尺寸 Machine size L×W×H	5760×864×1520mm	5770×991×1600mm	7260×1016×1500mm
機械淨/毛重 Machine WT. N.W. / G.W.	1600/2000kgs	1900/2100kgs	1900/2100kgs
包裝尺寸 Packing meas L×W×H	5893×1210×1676mm	5893×1460×1676mm	A 2235×1460×1219 B 5436×1460×1473

FJ15AC+25LC+25RC+25SCT × 2

半自動指接系統

Semi-Auto Finger Joint System



指樺成型機附佈膠

FJ-25RC

Right Finger Shaper



工作台面寬度 Max. length of table	630mm
木料最大加工尺寸 Max. length × height of workpiece	1000 × 150mm
木料最小加工尺寸 Min. length × height of workpiece	150 × 20mm
切斷鋸速度 Speed of cut off saw	3600R.P.M.- 60Hz, 3000R.P.M.- 50Hz
指接刀速度 Speed of finger cutter	6000R.P.M.- 60Hz, 5400R.P.M.- 50Hz
修邊鋸速度 Speed of scoring saw	3600R.P.M.- 60Hz, 3000R.P.M.- 50Hz
馬力 POWER REQUIRED	
切斷鋸馬力 Cut off saw	5 × 1HP
指接刀馬力 Finger cutter	20 × 1HP
皮帶傳動馬力 Conveyor driving motor	1/2 × 1HP
膠輪馬力 Glue roller	1/8 × 1HP
油壓幫浦馬力 Hydraulic pump	2 × 1HP
吸塵管直徑 Dia. of exhaust hood	4" × 4
吸塵量 Dust suction volume required	Aprox. 60m ³ /min
空氣消耗量 Air consumption	6kg/cm ²
機械尺寸 Machine dimensions	2080 × 1400 × 1350mm
包裝尺寸 Packing dimensions	2450 × 1500 × 1550mm
淨重/毛重 N.W. / G.W.	1410 / 1620kgs

指樺成型機

FJ-25LC

Left Finger Shaper



工作台面寬度 Max. length of table	630mm
木料最大加工尺寸 Max. length × height of workpiece	1000 × 150mm
木料最小加工尺寸 Min. length × height of workpiece	150 × 20mm
切斷鋸速度 Speed of cut off saw	3600R.P.M.- 60Hz, 3000R.P.M.- 50Hz
指接刀速度 Speed of finger cutter	6000R.P.M.- 60Hz, 5400R.P.M.- 50Hz
修邊鋸速度 Speed of scoring saw	3600R.P.M.- 60Hz, 3000R.P.M.- 50Hz
馬力 POWER REQUIRED	
切斷鋸馬力 Cut off saw	5 × 1HP
指接刀馬力 Finger cutter	20 × 1HP
皮帶傳動馬力 Conveyor driving motor	1/2 × 1HP
油壓幫浦馬力 Hydraulic pump	2 × 1HP
吸塵管直徑 Dia. of exhaust hood	4" × 4
吸塵量 Dust suction volume required	Aprox. 60m ³ /min
空氣消耗量 Air consumption	6kg/cm ²
機械尺寸 Machine dimensions	2040 × 1400 × 1350mm
包裝尺寸 Packing dimensions	2200 × 1500 × 1550mm
淨重/毛重 N.W. / G.W.	1320 / 1520kgs

鉋花機 ROUTERS

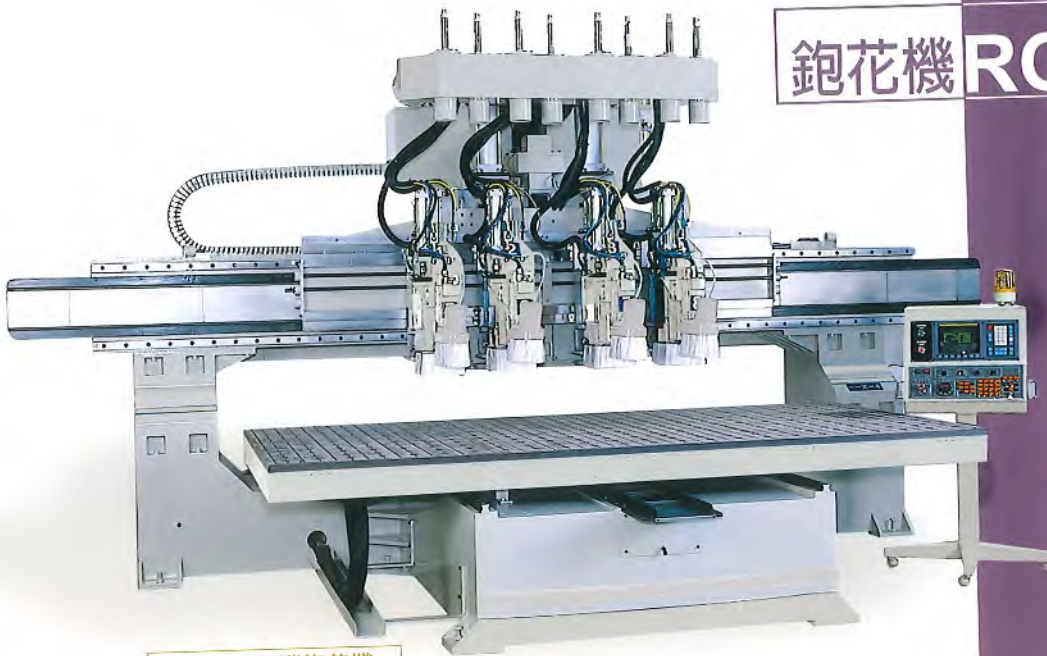

CNC電腦鉋花機
CNC Router

SH-RO-403J-PB

Spindle	8
Number of spindle	2000-18500R.P.M.
Speed	240-700mm
Distance between spindle	Oil mist
Spindle lub.	
Table size	4' × 8' / 5' × 10'
4' × 8' or 5' × 10'	2540 / 3140mm
Longitudinal(X-Axis)	1320 / 1620mm
Cross(Y-Axis)	200mm
Vertical(Z-Axis)	
Max. feed speed	24M/min
X,Y Axes	9M/min
Z Axis	

Tools	
Router bit shank	12mm, 16mm(also in inches)
Shaper cutter diameter	Ø30mm(inner) / 230mm(outer)
Motor	
Main spindle	10HP × 4
Piggy back	3HP × 4
Vacuum	7.5HP
Air pressure	6kg/cm ²
Dimensions	
Floor space required	5200 × 3300 / 6000 × 4000mm
Height	2850mm
Weight	8200 / 9700mm
CNC system	Fanuc or Mitsubishi



CNC電腦複合加工機
CNC Processing Center

STRATOS/SUP

Stroke	3400mm
X-Axis	2180mm
Y-Axis	250mm
Z-Axis	3200 × 1600mm
Table size	2
Vacuum area	
Max. feed speed	
X,Y-Axis	36M/min
Z-Axis	10M/min
No. 1 ATC head	
Speed	1000-18000R.P.M.
Spindle nose	SK30
Number of tools	8
No. 2 Multi-drill 5 × 5+4Side drill & saw	
Speed	6000R.P.M.
Shank of drill	Ø10mm
Tooling	

Shank of router bit	MAX, Ø25mm
Power	
No. 1 atc head	7.5kw × 1
No. 2 Multi-drill	1.5kw × 1
Vacuum pump 250 cbm/hr	6.6kw 50/60Hz
Total power	20kw / 68A
Air pressure	
Hose:3/4	6kg/cm ²
Consumption	300l/min
NC controller	ANDI-FANUC
Dimension	
Floor area	6000 × 3550mm
Height	2800mm
Weight	4800kgs
Extraction	
Flow	3300m ³ /hr
Diameter	1 × Ø200mm

ROUTERS 立軸鉋花機



昇降頭鉋花機
YL-750 Sliding Head Router

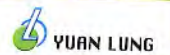

夾頭至工作台面最大距離 Chuck to table maximum	210mm
喉深 Throat depth	770mm
工作馬達 Working motor	3HP or 5HP
工作台尺寸 Table size	810 × 710mm(32" × 28")
工作台傾斜 Table tilt	45°
主軸行程 Spindle stroke	75mm
主軸轉速 Spindle speeds	10000 / 20000R.P.M.
套筒尺寸 Collet size	12 / 16mm
機械尺寸 Machine size	1600 × 810 × 1550mm
機械淨/毛重 Machine N.W./G.W.	700 / 750kgs



大型鉋花機
YL-650 High Router (Large)



夾頭至工作台面最大距離 Chuck to table maximum	178mm
喉深 Throat clearance	670mm
工作馬達 Working motor	3HP or 5HP
工作台尺寸 Table size	760 × 508mm(30" × 20")
工作台傾斜 Table tilt	45°
主軸轉速 Spindle speeds	10000 / 20000R.P.M.
套筒尺寸 Collet size	12 / 16mm
機械尺寸 Machine size	1500 × 760 × 1500mm
機械淨/毛重 Machine N.W./G.W.	600 / 650kgs



小型鉋花機
YL-620 High Router (Light duty)



夾頭至工作台面最大距離 Chuck to table maximum	90mm
喉深 Throat depth	405mm
工作馬達 Working motor	1HP or 2HP
工作台尺寸 Table size	500 × 400mm(20" × 16")
工作台傾斜 Table tilt	45°
主軸轉速 Spindle speeds	20000R.P.M.
套筒尺寸 Collet size	12 / 16mm
機械尺寸 Machine size	710 × 430 × 1230mm
機械淨/毛重 Machine N.W./G.W.	200 / 250kgs

加大型雙立軸機 Double Spindle Shaper (Large)



	YL-255L	YL-257L
主軸直徑 Spindle diameter	1" or 1 1/4" or 30mm or 40mm	1" or 1 1/4" or 30mm or 40mm
主軸中心距 Distance between spindle	660mm	660mm
主軸行程 Stroke travel	80mm	80mm
主軸轉速 Spindle speeds	10000R.P.M.	10000R.P.M.
工作台尺寸 Table size	1980 × 940mm	1980 × 940mm(78" × 37")
工作台嵌板直徑 Table insert opening diameter	140mm	140mm
工作馬達 Working motor	5HP × 2	7 1/2HP × 2
機械尺寸 Machine size	1980 × 940 × 1000mm	1980 × 940 × 1000mm
機械淨/毛重 Machine N.W./G.W.	800 / 850kgs	800 / 850kgs



大型雙立軸機 Double Spindle Shaper(Large)



	YL-255	YL-257
主軸直徑 Spindle diameter	1" or 1 1/4" or 30mm or 40mm	1" or 1 1/4" or 30mm or 40mm
主軸中心距 Distance between spindles	660mm(26")	660mm(26")
主軸行程 Stroke travels	80mm(3 1/4")	80mm(3 1/4")
主軸轉速 Spindle speeds	10000R.P.M.	10000R.P.M.
工作台尺寸 Table size	1400×890mm(55"×35")	1400×890mm(55"×35")
工作台嵌板直徑 Table insert opening diameter	140mm	140mm
工作馬達 Working motor	5HP×2	7 1/2HP×2
機械尺寸 Machine size	1400×890×1000mm	1400×890×1000mm
包裝尺寸 Packing size	1500×950×1150mm	1500×950×1150mm
淨重/毛重 N.W. / G.W.	650 / 700kgs	650 / 700kgs



雙立軸機 Double Spindle Shaper



	YL-223	YL-225
主軸直徑 Spindle diameter	1" or 1 1/4" or 30mm or 40mm	1" or 1 1/4" or 30mm or 40mm
主軸中心距 Distance between spindles	410mm(16")	410mm(16")
主軸行程 Stroke travels	80mm(3 1/4")	80mm(3 1/4")
主軸轉速 Spindle speeds	10000R.P.M.	10000R.P.M.
工作台尺寸 Table size	1020×740mm(40"×29")	1020×740mm(40"×29")
工作台嵌板直徑 Table insert opening diameter	140mm	140mm
工作馬達 Working motor	3HP×2	5HP×2
機械尺寸 Machine size	1020×740×1000mm	1020×740×1000mm
包裝尺寸 Packing size	1070×770×1150mm	1070×770×1150mm
淨重/毛重 N.W. / G.W.	500 / 550kgs	500 / 550kgs



大型單立軸機 Single Spindle Shaper(Large)



	YL-155	YL-157
主軸直徑 Spindle diameter	1" or 1-1/4" or 30mm or 40mm	1" or 1-1/4" or 30mm or 40mm
主軸行程 Stroke travel	80mm(3 1/4")	80mm(3 1/4")
主軸轉速 Spindle speeds	10000R.P.M.	10000R.P.M.
工作台尺寸 Table size	1020×920mm(40"×36")	1020×920mm(40"×36")
工作台嵌板直徑 Table insert opening diameter	140mm	140mm
工作馬達 Working motor	5HP	7 1/2HP
機械尺寸 Machine size	1020×920×1000mm	1020×920×1000mm
淨重/毛重 N.W./G.W.	500 / 550kgs	500 / 550kgs



單立軸機 Single Spindle Shaper



	YL-113	YL-115
主軸直徑 Spindle diameter	1" or 1-1/4" or 30mm or 40mm	1" or 1-1/4" or 30mm or 40mm
主軸行程 Stroke travel	80mm	80mm
主軸轉速 Spindle speeds	10000R.P.M.	10000R.P.M.
工作台尺寸 Table size	920×760mm(36"×30")	920×760mm(36"×30")
工作台嵌板直徑 Table insert opening diameter	140mm	140mm
工作馬達 Working motor	3HP	5HP
機械尺寸 Machine size	920×760×1000mm	920×760×1000mm
機械淨/毛重 Machine N.W./G.W.	450 / 450kgs	450 / 450kgs





立軸鉋花機 SH-60 Shaper Router

使用馬達 Motor	2HP
工作台尺寸 Table surface area	650 × 580mm(25 1/2" × 22 3/4")
主軸行程 Spindle travel	3"
主軸轉速 Spindle speed	1800R.P.M.
套筒尺寸 Coller size	1/4", 3/8", 1/2"(6/9/12mm)
排屑管外徑 Dust hood outlet	Ø2"
機械尺寸 Machine size	32" × 26" × 31"
裝箱尺寸 Packing size	35" × 29" × 37"
淨重/毛重 N.W. / G.W.	190 / 225kgs



立軸鉋花機 SH-150 Shaper Router

型刀最大高度	75mm
型刀最大外徑	60mm
淨重/毛重 N.W. / G.W.	580 / 1120kgs
機械尺寸 Machine size	950 × 800 × 1380mm
裝箱尺寸 Packing size	1090 × 900 × 1520mm
兩主軸中心距離	150mm
主軸直徑	Ø3/4"
馬達驅動	2HP
主軸轉速	1000R.P.M.
送材輪數	3 sets
送材輪直徑	100mm
使用馬達	1/3HP



自動送材機 Auto Power Feeder

	YL-440	YL-460	YL-470
送材速度 Feeding speed	8,12,16M/min	8,12,16M/min	8,12,16M/min
送材輪直徑 Feed wheel diameter	100mm	100mm	48mm
送材輪數量 Spindle	4pcs	6pcs	7pcs
工作馬達 Working motor	1/2HP × 1	1/2HP × 1	1/2HP × 1
機械尺寸 Machine size	470 × 650 × 750mm	720 × 720 × 750mm	400 × 650 × 750mm
機械淨/毛重 Machine N.W. / G.W.	72kgs	80kgs	75kgs



SH-70 平行式手動夾鉗
Open Type Manual Clamp

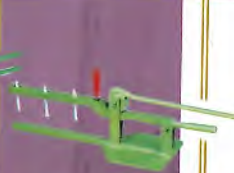

SH-125 平行式手動夾鉗
Open Type Manual Clamp



SH-200 開邊式活動夾鉗
Open Type Manual Clamp



SH-225 方型活動夾鉗
Square Type Manual Clamp



SH-300 方型活動夾鉗
Square Type Manual Clamp



SH-255A 電動鉗
Air Operated Clamp



SH-300A 氣壓式電動鉗
Air Operated Clamp

仿型機 COPY SHAPER

單軸仿型自動鉋邊機 Automatic Copy Shaper

	SH-22	SH-28	SH-36
最大圓形加工 Max. cutting circle	22"	28"	40"
最小圓形加工 Min. cutting circle	2"	3-1/2"	3-1/2"
最大矩形加工 Max. rectangle(2:1)	18"×12"	25"×12"	32"×18"
工作台直徑 Table diameter	Ø34"	Ø18"	Ø26"
主軸直徑 Cutter spindle diameter	Ø30mm	Ø30mm	Ø30mm
導輪直徑 Follower roller diameter	Ø90mm	Ø100mm	Ø100mm
工作台轉速 Table speeds	1.5-4.0R.P.M.	1.5-4.0R.P.M.	1.5-4.0R.P.M.
	Variable	4 speeds	4 speeds
主軸轉速 Cutter spindle speed	9000 or 16000R.P.M.	9000R.P.M.	9000R.P.M.
工作台馬力 Table drive motor	2HP	1HP	1HP
主軸馬力 Citterhead drive motor	7 1/2HP	7 1/2HP	7 1/2HP
所需氣壓 Working air pressure required	5.0kg/cm ²	5.0kg/cm ²	5.0kg/cm ²
淨重/毛重 N.W./G.W.	920 / 1200kgs	750 / 950kgs	850 / 1150kgs



單軸仿型自動鉋邊機

SH-62 Automatic Copy Shaper

最大圓形加工 Maximum cutting circle	62"
最小圓形加工 Minimum cutting circle	2"
最大矩形加工 Maximum rectangle(2:1)	18"×12"
工作台直徑 Table diameter	Ø34"
主軸直徑 Cutter spindle diameter	Ø30mm
導輪直徑 Follower roller diameter	Ø90mm
工作台轉速 Table speeds	1.5-4.0R.P.M.(variable)
主軸轉速 Cutter spindle speed	9000 or 16000R.P.M.
工作台馬力 Table drive motor	2HP
主軸馬力 Citterhead drive motor	7 1/2HP
所需氣壓 Working air pressure required	5.0kg/cm ²
淨重/毛重 N.W./G.W.	920 / 1200kgs



特大型自動仿型鉋邊機 Heavy Duty Automatic Copy Shaper

	SH-80	SH-120
最大圓形加工 Max. cutting circle	80"	120"
最小圓形加工 Min. cutting circle	20"	24"
最大矩形加工 Max. rectangle(2:1)	65"×36"	110"×44"
工作台直徑 Table diameter	65"	93"
主軸直徑 Cutter spindle diameter	1 1/4"×2	1 1/4"×2
導輪直徑 Follower roller diameter	100mm×2	100mm×2
工作台轉速 Table speeds	0.4-4.0R.P.M.	0.4-4.0R.P.M.
主軸轉速 Cutter spindle speed	9000R.P.M.	9000R.P.M.
工作台馬力 Table drive motor	2HP	5HP(直流)
主軸馬力 Citterhead drive motor	10HP×1.10HP×1	15HP×1.10HP×1
所需氣壓 Working air pressure required	5.0kg/cm ²	5.0kg/cm ²
淨重 N.W.	3350kgs	4350kgs



特大仿型自動鉋邊機(附磨砂裝置) Heavy Duty Automatic Copy Shaper

	SH-80AS	SH-100AS
最大圓形加工 Max. cutting circle	80"	100"
最小圓形加工 Min. cutting circle	20"	22"
最大矩形加工 Max. rectangle(2:1)	71"×35"	86"×44"
工作台直徑 Table diameter	Ø66"	Ø75"
主軸直徑 Cutter spindle diameter	Ø30mm	Ø30mm
導輪直徑 Follower roller diameter	Ø100mm	Ø100mm
工作台轉速 Table speeds	0.4-4.0R.P.M. (D.C. Variable)	0.4-4.0R.P.M. (D.C. Variable)
主軸轉速 Cutter spindle speed	9000R.P.M.	9000R.P.M.
工作台馬力 Table drive motor	2HP(DC)	3HP(DC)
主軸馬力 Citterhead drive motor	10HP×2	10HP×1, 15HP×1
砂光馬力	2HP	2HP
砂光主軸轉速	800-1400R.P.M.	800-1400R.P.M.
所需氣壓 Working air pressure required	5.0kg/cm ²	5.0kg/cm ²
淨重/毛重 N.W./G.W.	4200 / 4900kgs	4800 / 5600kgs



TENONING MACHINE 作榫機



CF-100A2 高產量圓棒成型機 High Productivity Round Rod Moulder

加工範圍 Range of work diameter	2 to 30mm
上軸馬力 Upper spindle	7 1/2HP
下軸馬力 Bottom spindle	7 1/2HP
送料馬力 Feed motor	1HP
刀具尺寸Cutter size	110×100×30mm
最大加工寬度 Max. working width	100mm(4")
主軸轉速 Spindle speed	6500R.P.M.
送料速度 Feed speed	4-13M/min
吸塵罩口徑 Chip chute diameter	Ø100mm(Ø4")
機械尺寸Machine size	1780×850×1250mm
裝箱尺寸Packing size	1900×990×1450mm
淨重 Net weight	950kgs
毛重 Gross weight	1100kgs



DCC-220 高速木榫橫切倒角機 High Speed Dowel Cross-Cut and Chamfering Machine

加工範圍 Range of work diameter	6 to 18mm
最短切斷長度Minimum cutting length	30mm
最長切斷長度Maximum cutting length	150mm
產能Capacity	About 7500-15000 dowels/hour
送料馬力 Feed motor	1/2 HP
第一倒角刀馬力First chamfering motor	1/2 HP
第二倒角刀馬力Second chamfering motor	1/2 HP
切斷鋸片馬力Cutting motor	1/2 HP
機械尺寸 Machine size	1000×700×880mm
裝箱尺寸 Packing size	1200×930×1080mm
淨重 Net weight	340kgs
毛重 Gross weight	420kgs



CF-18 圓棒製造機 Dowel Milling Machine

加工範圍 Range of work diameter	6 to 18mm
加工長度 Range of work length	240mm-無限長unlimited
主軸馬力 Drive motor	1HP
送料速度 Feed speed	6 M/min
加工速度 Cutting rate	36piece/min
機械尺寸 Machine size	560×440×580mm
裝箱尺寸 Packing size	620×500×750mm
裝箱尺寸 Packing size(CF-18+CF-36)	870×690×750mm/180kg
淨重 Net weight	65kgs
毛重 Gross weight	90kgs



CF-36 圓棒橫切倒角機 Dowel Cross-Cut and Chamfering Machine

加工範圍 Range of work diameter	6 to 18mm
加工長度 Range of work length	20mm-150mm
主軸馬力 Drive motor	1/2 HP
送料速度 Feed speed	6 M/min
加工速度 Cutting rate	36piece/min
機械尺寸 Machine size	560×500×580mm
裝箱尺寸 Packing size	620×610×750mm
裝箱尺寸 Packing size(CF-18+CF-36)	870×690×750mm/180kg
淨重 Net weight	70kgs
毛重 Gross weight	100kgs

圓棒製造機 Round Rod Milling Machine

	CF-60	CF-80
加工範圍 Range of work diameter	Ø10-Ø60mm	Ø10-Ø80mm
加工長度 Range of work length	300mm-無限長unlimited	300mm-無限長unlimited
主軸馬力 Drive motor	5HP	10HP
送料馬力 Feed motor	2HP	2HP
主軸轉速 Cutterhead speed	3400R.P.M.	3400R.P.M.
送料速度 Range of feed speeds	10/12/14/16M/min(4 speed)	6/8/10/12M/min(4 speed)
排屑管口直徑 Chip chute diameter	Ø100mm(Ø4")	Ø100mm(Ø4")
機械尺寸 Machine size	800×690×910mm	900×690×910mm
裝箱尺寸 Packing size	890×730×1100mm	990×730×1100mm
淨重 Net weight	320kgs	370kgs
毛重 Gross weight	370kgs	430kgs



多軸圓棒製造機

CF-60S Multiple Round Rod Milling Machine

加工範圍 Range of work diameter	Ø10-Ø60mm
加工長度 Range of work length	400mm-無限長unlimited
主軸馬力 Drive motor	7 1/2HP / 5HP
送料馬力 Feed motor	2HP
主軸轉速 Cutterhead speed	6000R.P.M.
送料速度 Range of feed speeds	14/16/18/20 mater/min
排屑管口直徑 Chip chute diameter	Ø100mm(Ø4")
機械尺寸 Machine size	1360×690×910mm
裝箱尺寸 Packing size	1470×715×1150mm
淨重/毛重 N.W. / G.W.	560 / 650kgs



單帶圓棒砂光機

CF-80B Round Rod Sanding Machine

加工範圍 Range of work diameter	Ø5-Ø80mm
加工長度 Range of work length	100mm-無限長unlimited
使用馬力 Drive motor	3HP
風車馬力 Vaccum suction motor	1/2HP
砂帶規格 Sand belt size	125×1860mm(5"×73")
砂帶速度 Belt speed	18M/sec
送料速度 Feed speed	6-20M/min
機械尺寸 Machine size	750×510×1340mm
裝箱尺寸 Packing size	840×650×1520mm
淨重 Net weight	290kgs
毛重 Gross weight	350kgs



雙帶圓棒砂光機

CF-80B2 Double Belt Round Rod Sanding Machine

加工範圍 Range of work diameter	Ø5-Ø80mm
加工長度 Range of work length	200mm-無限長unlimited
使用馬力 Drive motor	5HP
風車馬力 Vaccum suction motor	1/2HP
砂帶規格 Sand belt size	125×1860mm(5"×73")
砂帶速度 Belt speed	18M/sec
送料速度 Feed speed	6-20M/min
機械尺寸 Machine size	950×650×1340mm
裝箱尺寸 Packing size	1100×790×1560mm
淨重 Net weight	390kgs
毛重 Gross weight	470kgs



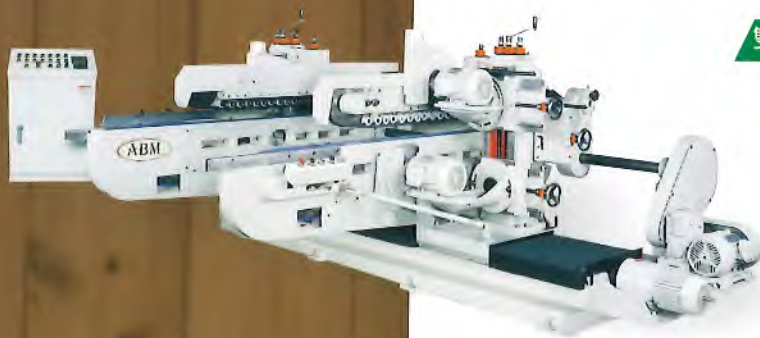

雙端作榫機 Double End Tenoners

ABM HWA SHIN

	HS-66K	HS-86K
最大加工尺寸 Max. Working size	50×610×1850mm	50×610×2450mm
主鋸直徑×軸徑 Main saw dia.×Spindle dia.	Ø305mm×Ø25.4mm	Ø305mm×Ø25.4mm
槽鋸直徑×軸徑 Scoring saw dia.×Spindle dia.	Ø203mm×Ø25.4mm	Ø203mm×Ø25.4mm
立鋸力直徑×軸徑 Vertical saw dia.×Spindle dia.	Ø203-254mm×Ø25.4mm	Ø203-254mm×Ø25.4mm
送料速度 Feed speed(無段變速Auto-speeding)	6-20M/min	6-20M/min
主鋸馬力 Main saw motor	2P×5HP×2	2P×5HP×2
槽鋸馬力 Scoring saw motor	2P×3HP×2	2P×3HP×2
立軸馬力 Vertical spindle motor	2P×5HP×2	2P×5HP×2
送料馬力 Feed motor	4P×5HP×1	4P×5HP×1
定寬馬力 Width-setting motor	4P×1HP×1	4P×1HP×1
機械尺寸 Machine size	3450×2750×1400mm	4280×2800×1450mm
包裝尺寸 Packing size	4800×2280×1730mm	5640×2280×1780mm
機械重量 Machine weight	3250 / 4250kgs	3650 / 4650kgs

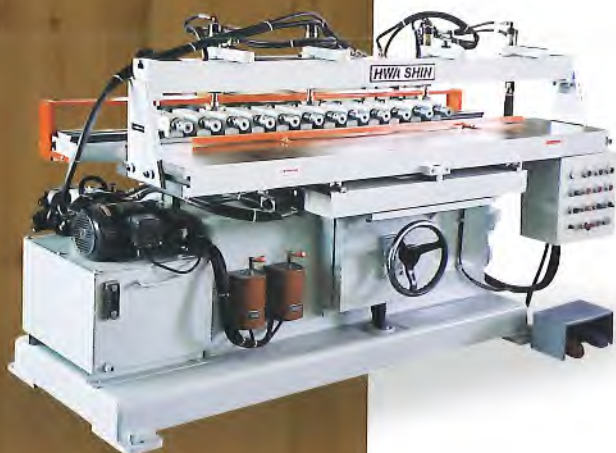

HS-512 銑槽機 Hydraulic Oval Boring Machine

ABM HWA SHIN

工作台面尺寸 Table size	380×1860mm
主軸馬達 Spindle motor	5HP×2
搖動馬達 Shake spindle motor	1HP×1
油壓馬達 Hydraulic pump motor	2HP×1
行程 Stroke travel	100mm
主軸數 Number of spindle	12
孔距 Shake ability	0-80mm
最大鑽孔孔徑 Max. boring diameter	15
壓料 Hold-down clamp	4
裝箱尺寸 Packing size	2420×1270×1347mm
淨重/毛重 N.W./G.W.	1400 / 1600kgs



TM-120 / TM-152 單端作榫機 Single End Tenoner

MAXIMUM TENON CUT	
Length	120mm / 152mm
Width	370mm
Thickness	112mm / 127mm
Max. tenoning cutterhead size	Ø105mm (dia.)
Max. shaping cutter size	Ø10"
Max. sawblade diameter	Ø12"
SPINDLE DIAMETER	
Tenon spindle	Ø1" / Ø1 1/4"
Cope spindle	Ø1"
Saw spindle	Ø1" / Ø1 1/4"
SPINDLE SPEED	
Tenon spindle	3400R.P.M.
Cope spindle	3600R.P.M.
Saw blade	2800R.P.M.
MOTOR HORSEPOWER	
Saw & tenon head	3HP / 5HP
Cope head	2HP / 3HP
Sliding table area	1280×450mm
Net weight	500 / 530kgs
Gross weight	620 / 650kgs
Machine dimensions	1680×1840×1150mm
Packing dimensions	1730×900×1300mm



TM-700 空壓三用作榫機 Pneumatic Triple-Function Tenonner

Using Radial Saw Blade & Vertical Spindle	405×3.2×40×100T
Motor of Radial Saw	3HP×4P×1pc
Revolution Speed of Radial Saw	2050R.P.M.
Drilling Head Motor	2HP×2P2×1pc
Revolution Speed of Drilling Head	2800R.P.M.
Vertical Spindle Main Shaft Diameter	30mm
Max. Size of Grooved Tenon Cutter	160mm
Vertical Spindle Motor	5HP×2P×1pc
Revolution Speed of Vertical Spindle	6000R.P.M.
N.W. / G.W.	750 / 860kgs
Size of Machine	1350×1200×1230mm
Size of Machine with Wooden Case	1480×1330×1350mm

SKT-115 長方榫頭作榫機
Rectangular Tenoner

主軸轉速 Spindle speed	6000R.P.M.
榫頭最大寬度 Maximum tenon width	115+2Rmm
榫頭深度 MAXIMUM TENON DEPTH	
標準刀具 with standard tool	10-45mm
特殊刀具 with special tools	6-90mm
工作台 TABLE TILT	
上傾 upward	0-15°
下傾 downward	0-30°
側傾 Side	0-20°
主軸馬力 Spindle motor	5HP
進刀馬力 Cutter cycle motor	1HP
淨重/毛重 N.W. / G.W.	1100 / 1200kgs
機械尺寸 Machine size	1760×1150×1320mm
裝箱尺寸 Packing size	1870×1240×1620mm



TM-168 CNC雙軸作榫機
CNC Double Tenoner

刀軸轉速 Spindle speed	6600R.P.M.
榫頭最大寬度 Maximum tenon width	130mm
榫頭深度 MINIMUM TENON DEPTH	
標準刀具 with standard tools	10-45mm
特殊刀具 with special tools	6-75mm
工作台 TABLE TILT	
上傾 upward	0-15°
下傾 downward	0-30°
側傾 Side	0-20°
刀軸馬達 Spindle motor	3HP
淨重/毛重 N.W. / G.W.	850 / 950kgs
機械尺寸 Machine size	2000×1160×1560mm
裝箱尺寸 Packing size	2120×1280×1770mm



多軸銑槽機 Multiple Spindle Oscillation Mortiser

	SKM-3	SKM-4
滑座數 Numbers of carriage	3 / 4sets	3 / 4sets
主軸數 Numbers of spindle	3-6spindle	3-6spindle
槽孔最大寬度 Max. mortise width	100mm	100mm
槽孔最大深度 Max. mortise depth	30mm	30mm
銑刀直徑 Cutter diameter	6-25mm	6-25mm
刀柄直徑 Cutter shank diameter	16mm	16mm
兩軸最小中心距 Min. distance between spindles	90mm	90mm
擺動速率 Oscillation speed(2 speeds)	95 / 190strokes	95 / 190strokes
刀軸轉速 Spindle speeds	6000R.P.M.	12000R.P.M.
槽孔傾斜角度 Tilted mortise angle	20°	20°
刀軸馬達 Spindle motor	1.8HP	1.8HP
擺動馬達 Oscillation drive motor	1HP	1HP
使用空氣壓力 Working air pressure	5-6kg/cm ²	5-6kg/cm ²
集塵罩出口徑 Dust hood outlet diameter	4"	5"
淨重 N.W.	1350 / 1450kgs	1350 / 1450kgs
毛重 G.W.	1650 / 1750kgs	1650 / 1750kgs
機械尺寸 Machine dimensions	2420×1380×1480mm	2420×1380×1480mm
	2420×1380×1650mm	2420×1380×1650mm
裝箱尺寸 Packing dimensions	2550×1510×1680mm	2550×1510×1680mm
	2550×1510×1850mm	2550×1510×1850mm





手動三角榫機 Dovetail Tenoner

	TM-8	TM-16
使用馬達 Motor	2HP × 1P.C.	2HP × 2P.C.S
加工程度	3/8"-1" × 8 1/4"	3/8"-1" × 16 1/4"
刀數	8	16
主軸迴轉數 Spindle speed	5100R.P.M.	5100R.P.M.
機械尺寸 Machine size	31" × 28" × 49"	39" × 28" × 49"
裝箱尺寸 Packing size	35" × 29" × 51"	43" × 29" × 51"
機械淨重 N.W.	340kgs	600kgs
機械總重 G.W.	490kgs	780kgs



三角榫機 Tenonner

榫頭厚度 Thickness of Tenor	MIN:7mm MAX:60mm
榫頭寬度 Width of Tenor	MIN:6mm MAX:18mm
榫頭深度 Depth of Tenor	MIN:10mm MAX:30mm
Up and Down Adjusting Amount of Tool Shaft	30mm
Maximum Work Piece Size	L:1500mm W:480mm
Specification of Tool Clamping Head.	Ø12mm
Clamping Material Cylinder Number	4PCS
Turning Number of Tool Shaft	21500R.P.M.
Tool Shaft Motor	2HP
Working Atmospheric Pressure	5kg
Exit Diameter of Dust Cage	60mm
機械尺寸 Machine Dimension	1330 × 850 × 1200mm
裝箱尺寸 Packing Dimension	1450 × 970 × 1410mm
淨重/毛重 N.W. / G.W.	480 / 570kgs



銑槽機 Oscillation Mortiser

槽孔最大寬度 Maximum width of mortise	120mm
槽孔最大深度 Maximum depth of mortise	50mm
擺動速率 Oscillation rate	6.6-400 stroke/min
台面上下調整高度 Table vertical adjustment	3"
刀軸速率 Cutter speed	9500R.P.M.
最大壓料厚度 Maximum clamp thickness	4"
刀軸馬力 Spindle motor	2HP
擺動馬力 Oscillation motor	1/2HP
使用空氣壓力 Air pressure	5-6kg/cm ²
機器尺寸 Machine size	1300 × 1200 × 1200mm
裝箱尺寸 Packing size	1450 × 1340 × 1450mm
淨重/毛重 N.W. / G.W.	700 / 800kgs



抽屜組合機 Dovetail & Cabinet Assembler

Assembling length	225-950mm
Assembling depth	280-360mm
Assembling height	100-275mm
Taper adjustment	0-5mm/side
機器尺寸 Machine size	2150 × 420 × 1150mm
裝箱尺寸 Packing size	2240 × 500 × 1270mm
淨重/毛重 N.W. / G.W.	315 / 425kgs
Pneumatic supply	5kg/cm ²

背刀車床 TURNING LATHE



全自動油壓背刀車床

CP-1250A/AP Full Hydraulic Hopper Feed Back Turning Lathe



工作直徑 Workpiece Dia.	10-130mm(150mm-up optional)
工作長度 Workpiece length	100-1120mm(1500mm optional)
主軸馬力 Main spindle motor	10HP(15, 20HP optional)
泵浦馬力 Oil-hyd Pump motor	3HP
馬達轉速 Machine speed	1800-3600R.P.M.
機械尺寸 Machine dimensions	3100 × 1600 × 2000mm
包裝尺寸 Overall dimensions	3400 × 1750 × 2200mm
淨重/毛重 N.W. / G.W	2800 / 3300kgs



全自動油壓背刀車床

CP-168A Full Hydraulic Hopper Feed Back Turning Lathe



工作直徑 Workpiece Dia.	10-100mm
工作長度 Workpiece length	100-700mm
主軸馬力 Main spindle motor	7 1/2HP
泵浦馬力 Oil-hyd Pump motor	3HP
機械尺寸 Machine dimensions	2250 × 1450 × 1800mm
包裝尺寸 Measurement dimensions	2320 × 1200 × 2000mm
淨重/毛重 N.W. / G.W	1700 / 2000kgs



車削工件砂光機

CP-48AN/AH Auto Turning Sander



工作直徑 Workpiece Dia.	10-130mm(150mm-up optional)
工作長度 Workpiece length	20-1200mm(1500mm-up optional)
工作速度 Working capacity	1-24pcs/min
砂紙 Sanding paper	8 layers / 7 layers
線刷輪 Wire brush wheel	1 set
工作件數 Workpiece No.	16 pcs
馬力 Used Power	7 1/2HP × 1, 1/2HP × 1, 1HP × 1
機械尺寸 Machine size	2620 × 1660 × 1960mm
包裝尺寸 Measurement dimension	2960 × 1860 × 2260mm
淨重/毛重 N.W / G.W.	1660 / 2060kgs

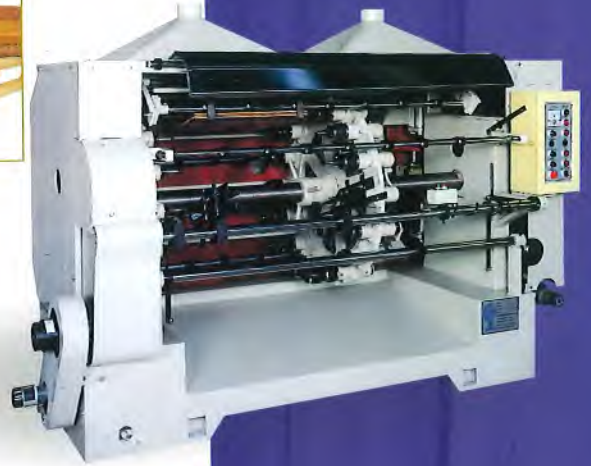

圓頭車枳砂光機

CP-416 Automatic Turning Sanders



工件直徑 Workpiece Dia.	20-150mm
工件長度 Workpiece length	15-130mm
工作件數 Workpiece No.	16 pcs
海綿紗布機	2 set
砂紙 Sanding paper	6 layers
馬力 Motor	7 1/2HP × 1, 1/2HP × 1, 1HP × 1
機械尺寸 Machine size	1700 × 1500 × 900mm

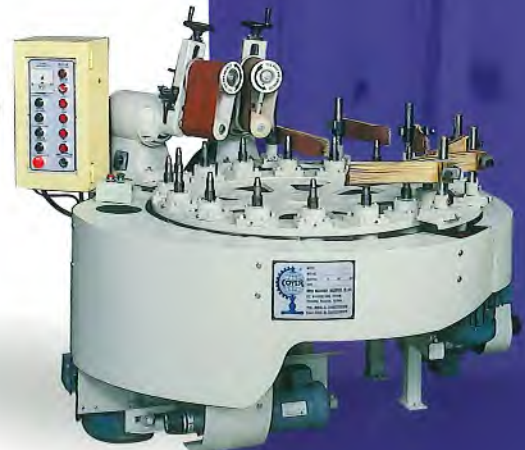



CP-350D 油壓直線及螺紋成形機
Hydraulic Straight & Spiral Groove Turning Lathe



工作直徑 Workpiece dia.	200mm
工作長度 Workpiece length	1300mm(1500mm optional)
最多凹槽數 Max number of grooves	24
行程 Cutterhead stroke	65mm
主軸轉速 Spindle speed	20000R.P.M.
刀頭數 Number of cutterheads	2 sets
刀頭馬達 Cutterhead drive motor	3HP × 2
可使用刀具 Applicable cutter	Milling cutter profile cutter
泵浦馬達 Hydraulic pump motor	3HP
驅動方式 Drive system	Hydraulic Motor & Ball Screw
機械尺寸 Machine dimensions	3200 × 1250 × 1550mm
包裝尺寸 Packing shipment	3400 × 1450 × 1850mm
淨重/毛重 N.W / G.W	1850 / 2100kgs



CP-350S/310H 油壓直線及螺紋成形機
Hydraulic Straight & Spiral Groove Turning Lathe



工作直徑 Workpiece dia.	150mm
工作長度 Workpiece length	1200mm
最多凹槽數 Max number of grooves	24
行程 Cutterhead stroke	60mm
主軸轉速 Spindle speed	20000R.P.M.
刀頭數 Number of cutterheads	1 set
馬力 Cutterhead drive motor	3HP
可使用刀具 Applicable cutter	Milling cutter profile cutter
泵浦馬力 Hydraulic pump motor	3HP
驅動 Drive system	Hydraulic Motor & Ball Screw
機械尺寸 Machine dimensions	2800 × 1280 × 1600mm
包裝尺寸 Packing shipment	2950 × 1480 × 1860mm
淨重/毛重 N.W / G.W	1450 / 1850kgs



CP-1300SA 油壓仿型木工車床
Hydraulic Copying Lathe



工作直徑 Workpiece dia.	20-130mm
工作長度 Workpiece length	100-1200mm(1500mm optional)
主軸馬力 Main spindle power	5HP
泵浦馬力 Oil-hyd pump motor	3HP
主軸轉速 Main spindle speed	900/1500/2200/3500R.P.M.
控制系統 Electrical control style	DC24V relay
仿型器行程 Stroke of copying unit	80mm
進料方式 Feeding system	Semiauto feeding system
機械尺寸 Machine dimensions	2650 × 1100 × 1550 mm
包裝尺寸 Packing shipment	2850 × 1300 × 1800 mm
淨重/毛重 N.W / G.W	1300 / 1750kgs



CP-113 自動油壓木工車床
Full Hydraulic Turning Lathe



工作直徑 Workpiece dia.	10-150mm(200mm optional)
工作長度 Workpiece length	20-420mm
主軸馬力 Main spindle power	7 1/2HP
泵浦馬力 Pump motor	3 HP
主軸轉速 Main spindle speed	1800-3480R.P.M.
機械尺寸 Machine dimensions	1700 × 1680 × 1400mm
包裝尺寸 Packing dimensions	1850 × 1800 × 1600mm
淨重/毛重 N.W / G.W.	1200 / 1500 kgs

*Accept special specification ordered. 接受特殊規格尺寸訂單。

CP-118**餐桌中柱成型車床
Dining Table Column Stander Turning Lathe**

工作直徑 Workpiece Dia.	100-300mm
工作長度 Workpiece length	100-700mm
主軸馬力 Main spindle power	7 1/2HP(10HP optional)
泵浦馬力 Pump motor	3HP
主軸轉速 Main spindle speed	720-2520R.P.M.
變速調整 Speed adjustment	By change pulley
控制系統 Electrical control style	By AC 220V relay control
送、卸料方式 Loading and unloading method	Manual operation
機械尺寸 Machine dimensions	1600/1300/1400mm
包裝尺寸 Packing shipment	1800 × 1500 × 1600mm
淨重/毛重 N.W. / G.W.	1350 / 1650kgs

**CP-103A****半自動油壓木工車床
Semi-Auto Hydraulic Wood Turning Lathe**

工作直徑 Workpiece dia.	10-130mm(160mm optional)
工作長度 Workpiece length	20-420mm
主軸馬力 Main spindle power	5HP
泵浦馬力 Pump motor	2HP
主軸轉速 Main spindle speed	1000-2800R.P.M.
機械尺寸 Machine dimensions	1550 × 1150 × 1250mm
包裝尺寸 Packing shipment	1650 × 1350 × 1450mm
淨重/毛重 N.W. / G.W.	630 / 800kgs

**CP-103H****半自動油壓木工車床
Semi-Auto Hydraulic Wood Turning Lathe**

工作直徑 Workpiece dia.	10-130mm(160mm optional)
工作長度 Workpiece length	20-420mm
主軸馬力 Main spindle power	5 HP
泵浦馬力 Pump motor	1 HP
主軸轉速 Main spindle speed	1000-2800R.P.M.
機械尺寸 Machine dimensions	1550 × 1150 × 1250mm
包裝尺寸 Packing shipment	1650 × 1350 × 1450mm
淨重/毛重 N.W. / G.W.	630 / 800kgs

**CP-101****木工車床
Wood Turning Lathe**

工作直徑 Workpiece diameter	300mm
工作長度 Workpiece length	1200mm(1500mm optional)
主軸馬力 Main spindle motor	2HP
手動上卸料 Manual for loading & unloading	
尾座主軸手動夾持 Tail spindle by manual to be tight	
尾座手動夾持裝置 Tail seat moving by manual	





CP-212A

油壓車枳雙端鑽孔機
CP-212A Hydraulic Double Ends Drilling Machine

工作直徑 Workpiece dia.	110mm
工作長度 Workpiece length	1080mm
主軸夾頭 Chuck capacity	15mm
鑽頭行程 Drill stroke	150mm(200 optional)
主軸轉速 Spindle speed	4560-3580-2580
馬力 Motor	3HP × 2(5HP Optional)
泵浦馬力 Pump motor	3HP
機械尺寸 Machine dimensions	2200 × 800 × 1360mm
包裝尺寸 Packing shipment	2400 × 1000 × 1560mm
淨重/毛重 N.W. / G.W.	1200 / 1500kgs

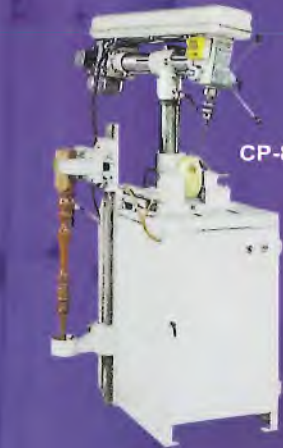

CP-806

多用途鑽孔機
CP-806 Multiple Drilling Machine

工作直徑 Workpiece dia.	780mm
最大鑽孔能力 Max. dia	16m/m
主軸錐度 Spindle conical	MT2
主軸行程 Spindle travel	80mm
變換速度(段) Speed chang by pully	9 sections
主軸轉速 Spindle speed	190-2600R.P.M. / 240-3200R.P.M.
主駐外徑 Scipe dia.	80mm
主軸心至工作盤距離 Distance between spindle, workeenter	640mm
馬達 Motor	2HP
總高度 Height	1850mm
總重量 Weight	200kgs
工作桌尺寸 Table size	750 × 450 × 850mm
工作桌工作面積 Table area	460 × 450mm



CP-805

立式鑽孔機
CP-805 Drilling Machine

工件加工長度 Workpiece length	1000mm
工作馬力 Power	2HP
機械尺寸 Machine size	1650 × 420 × 600mm
包裝尺寸 Packing size	1010 × 540 × 960mm
淨重/毛重 N.W. / G.W.	150 / 230kgs



CP-802

攻牙上螺絲機
CP-802 Drilling, Tapping & Screw Inserting Machine

工作能力 Working capacity	750pcs / HR以上
工作馬力 Power	1/2HP
機械尺寸 Machine size	930 × 460 × 850mm
包裝尺寸 Packing size	1010 × 540 × 960mm
淨重/毛重 N.W. / G.W.	80 / 100kgs



CP-801 / 801P

攻牙上螺絲機
CP-801/CP-801P Drilling, Tapping & Screw Inserting Machine

工作能力 Working capacity	900 pcs/hr
工作馬力 Power	1HP
機械尺寸 Machine size	930 × 460 × 850mm
包裝尺寸 Measurement	1010 × 540 × 960mm
淨重/毛重 N.W. / G.W.	150 / 230kgs



CP-804

樓梯扶手鑽孔機
CP-804 Drilling Machine of Staircase

加工長度 Range of work length	100mm-無限長unlimited
主軸轉速 Main spindle speed	800-1100R.P.M.
加工孔徑 Drilling capacity	2-33m/m
淨重/毛重 N.W. / G.W.	33kgs



*Accept special specification ordered. 接受特殊規格尺寸訂單。

砂光機 SANDING MACHINE

經濟型砂光機 Light Duty Wide Belt Sanding Machine

	WS-25A	WS-37A
最大砂光寬度 Max. working width	24"	36"
最大工件厚度 Max. working thickness	5"	4"
主馬達(標準) Main motor(standing)	7 1/2HP	15HP
主馬達(選購) Main motor(optional)	10HP	20HP
輸送帶馬達 Feed motor	1HP	2HP
工作昇降馬達 Table hoist motor	1/2HP	1/2HP
可選擇輸送速度無段變速範圍 Variable feed speed capacity	6-25 ± 5% M/min	6-25 ± 5% M/min
砂帶尺寸 Sanding belt size	25" × 48"	37" × 60"
工作氣壓 Working pressure	5kg/cm ²	5kg/cm ²
淨重/毛重 N.W. / G.W.	620 / 770kgs	900 / 1150kgs
機械尺寸 Machine size	139 × 120 × 160cm	165 × 150 × 172cm
裝箱尺寸 Packing size	148 × 130 × 179cm	175 × 160 × 191cm



標準型砂光機 Standard Duty Wide Belt Sanding Machine

	WS-25DA	WS-37DA
最大砂光寬度 Max. working width	24"	36"
最大工件厚度 Max. working thickness	5"	4"
主馬達(標準) Main motor(standard)	10, 7 1/2HP	20, 15HP
主馬達(選購) Main motor(optional)	15, 10HP	20, 20HP
輸送帶馬達 Feed motor	2HP	2HP
工作昇降馬達 Table hoist motor	1/2HP	1/2HP
可選擇輸送速度無段變速範圍 Variable feed speed capacity	6-25 ± 5% M/min	6-25 ± 5% M/min
砂帶尺寸 Sanding belt size	25" × 48"	37" × 60"
工作氣壓 Working pressure	5kg/cm ²	5kg/cm ²
淨重/毛重 N.W. / G.W.	1100 / 1300kgs	1500 / 1900kgs
機械尺寸 Machine size	160 × 160 × 165cm	165 × 180 × 175cm
裝箱尺寸 Packing size	169 × 169 × 185cm	175 × 190 × 94cm



重型寬帶砂光機 Heavy Duty Wide Belt Sanding Machine (適合薄片及板類砂光)

	WS-237RRC	WS-244RRC	WS-252RRC
工作寬度 Working width	915mm	1100mm	1300mm
工作厚度 Working height	3-150mm	3-150mm	3-150mm
主馬達 Belt motor	20/15/15HP	25/20/15HP	30/20/15HP
送料馬力 Feed motor	3HP	3HP	3HP
送料速度 Feed speeds	4-15M/min	4-15M/min	4-15M/min
昇降馬達 Lifting motor	0.5HP	0.5HP	0.5HP
砂帶尺寸 Belt size	940 × 1900mm	1120 × 1900mm	1330 × 1900mm
淨重 Net weight	2700kgs	3100kgs	3600kgs



重型寬帶砂光機 Heavy Duty Wide Belt Sanding Machine (適合實木及拼板砂光)

	WS-CCP-600H	WS-CCP-900H	WS-CCP-1100H	WS-CCP-1300H
最大砂光寬度 Working width	610mm	915mm	1100mm	1320mm
最大工件厚度 Working thickness	127mm	127mm	127mm	127mm
主馬達(標準/最大) Main motor STD/MAX	15/20HP	20, 15 / 25, 20HP	20, 25 / 30, 20HP	30, 20 / 40, 30HP
送料馬力 Feed motor	2HP	3HP	5HP	5HP
昇降馬達 Hoist motor	1/2HP	1/2HP	1/2HP	1HP
砂帶尺寸 Sanding belt size	25" × 84"	37" × 84"	43" × 84"	52" × 84"
送料速度 Feed speeds	4-16M/min	4-16M/min	4-16M/min	4-16M/min
淨重/毛重 N.W. / G.W.	2000 / 2200kgs	3500 / 3800kgs	4000 / 4300kgs	4500 / 5000kgs
裝箱尺寸 Packing size	62" × 66" × 87"	72" × 84" × 87"	85" × 89" × 87"	89" × 89" × 87"





重型寬帶砂光機 Heavy Duty Wide Belt Sanding Machine (不規則面底漆砂光機)

	WS-600HBE	WS-1000HBE	WS-1300HBE
最大工作寬度 Max. working width	600mm	1000mm	1300mm
最大工作厚度 Max. working thickness	125mm	125mm	125mm
砂帶馬力 Main motor	7 1/2HP	10HP	15HP
砂帶規格 Sanding belt size	25" × 75"	37" × 75"	51" × 75"
橫軸馬力 Lateral spindle motors	2HP × 2	2HP × 2	2HP × 2
送料馬力 Feed motor	2HP	2HP	2HP
棕刷馬達 Brush motor	1/2HP	1/2HP	1HP
工作台升降馬達 Table hoist motor	1/2HP	1/2HP	1/2HP
可選擇送料速度無段變速範圍 Variable feed speed capacity	3-12 ± 5%M/min	3-12 ± 5%M/min	3-12 ± 5%M/min
砂布輪外徑 Diameter of sand brush	305mm	305mm	305mm
工作氣壓 Working pressure	7kg/cm ²	7kg/cm ²	7kg/cm ²
淨重/毛重 N.W. / G.W.	2800 / 3050kgs	3200 / 3500kgs	3500 / 3800kgs
機械尺寸 Machine size	184 × 248 × 202cm	263 × 210 × 197cm	245 × 270 × 200cm
裝箱尺寸 Packing size	194 × 258 × 222cm	288 × 220 × 220cm	240 × 288 × 220cm



重型寬帶砂光機 Heavy Duty Wide Belt Sanding Machine (鉋砂機適用於拼板類)

	WS-610PRRK	WS-920PRRK	WS-1100PRRK	WS-1300PRRK
最大加工寬度 Max. working width	610mm	920mm	1100mm	1300mm
最大加工厚度 Max. working thickness	127mm	127mm	127mm	127mm
砂帶尺寸 Sanding belt size	635 × 1900mm	940 × 1900mm	1120 × 1900mm	1320 × 1900mm
標準馬力 Standard motor	20, 15, 10, 10HP	30, 20, 15, 15HP	30, 25, 15, 15HP	40, 40, 30, 20HP
送料馬力 Feed motor	3HP	5HP	5HP	7 1/2HP
工作台升降馬力 Table hoist motor	1/2HP	1/2HP	1/2HP	1/2HP
送料速度 Feed speeds	5-20M/min	5-20M/min	5-20M/min	5-20M/min
毛重 G.W.	3000kgs	3900kgs	4400kgs	5000kgs
機械尺寸 Machine size	109" × 55" × 81"	109" × 86" × 81"	109" × 92" × 81"	109" × 101" × 81"
包裝尺寸 Packing size	105" × 61" × 84"	105" × 90" × 84"	105" × 106" × 84"	105" × 110" × 84"



重型上下面砂光機 Heavy Duty Wide Belt Sanding Machine

	Duplex-610	Duplex-920	Duplex-1300
Number of units	2mm	2mm	2mm
加工寬度 Working width	610mm	920mm	1300mm
加工厚度 Workpiece thickness min.-max.	3-150mm	3-150mm	3-150mm
加工高度 Operation height	900mm	900mm	900mm
皮帶寬度 Belt width	635mm	940mm	1320mm
皮帶長度 Belt length	1905mm	1905mm	1905mm
送料速度 Feed speeds	5-15M/min	5-15M/min	5-15M/min
主軸馬力 Main motor(s) power HP1 / HP2	20 / 10	20 / 15	30 / 20
送料馬力 Feed motor	2HP	3HP	3HP
升降馬力 Height adjustment motor power	1HP	1HP	1HP
總馬力 Total power	33HP	39HP	54HP
空壓需求 Air pressure bar	6	6	6
長度 Length	2100mm	2100mm	2100mm
寬度 Width	1200mm	1500mm	1900mm
高度 Height	1900mm	1900mm	1900mm



上調式銑板機 Milling Machine

	WS-MUN-610	WS-MUN-1300
加工寬度 Working width	610mm	1300mm
加工厚度 Workpiece thickness min., max.	6-150mm	6-150mm
加工高度 Operation height	900mm	900mm
最小加工長度 Min. workable length	380mm	380mm
Number of units	2	4
送料速度 Feed speed	5-15M/min	5-15M/min
主馬力 Main motor (s) power	20HP	20HP × 2
送料馬力 Feed motor	2HP	3HP
調整高度馬力 Height adjustment motor power	1HP	1HP
馬力總數 Total power	23	44
空壓需求 Air pressure bar	6	6
長度 Length	1700mm	1700mm
寬度 Width	1200mm	1900mm
高度 Height	1900mm	1900mm

椅座砂光機

WS-EBS-1 Chair Seat Sanding Machine

椅座最大寬度 Max. seat width	22"
椅座最大長度 Max. seat length	18"
椅座最大厚度 Max. seat height	2"
送料座速度 Carriage feed rate	0-30ft/min
主軸馬力 Main motor	10HP
送料馬力 Feed motor	1HP(Hydraulic)
砂帶尺寸 Sanding belt size	3" × 184"
安裝空間 Floor space	70" × 75" × 88"



琴鍵式椅面砂光機

WS-KS570 Key Board Style Seat Sanding Machine

砂帶馬達 Sanding belt motor	10HP Two speed
進料 Feed	Cylinder with air hydro unit
最大砂光尺寸 Max. sanding size	560 × 600 × 120mm
淨重/毛重 N.W. / G.W.	750 / 950kgs
包裝尺寸 Packing size	232 × 100 × 195mm



多軸平面砂光機

WS-390 Multi-Cylinder Transverse Belt Sanding Machine

加工尺寸 Working size	1200 × 1800mm
砂帶尺寸 Sanding belt size	125 × 8430mm
砂帶驅動馬力 Sanding belt motor	5段變速(5 speed)
吹塵馬力 Dust blowing motor	25W × 1/40
砂帶轉速 Sanding belt speed	120-600M/min
墊帶尺寸 Felt belt size	100 × 6850mm
墊帶速度 Felt belt speed	122-610M/min
空氣消耗量 Air consumption	5kg/cm ²
機械尺寸 Machine size	4300 × 2210 × 1420mm
裝箱尺寸 Pacing size	4550 × 2460 × 1770mm
淨重/毛重 N.W. / G.W.	1360 / 1720kgs



單、雙帶平面手壓砂光機 Single, Double Belt Hand Stroke Sanding Machine

	WS-190	WS-290
最大加工尺寸 Max. size of work	2400 × 1200mm	2400 × 1200mm
砂帶尺寸 Sanding belt size	150 × 6550mm	150 × 6550mm
砂帶驅動馬力 Sanding belt motor	3HP	5HP
機械尺寸 Machine size	3330 × 870 × 1500mm	3330 × 1070 × 1500mm
裝箱尺寸 Packing size	3580 × 1120 × 1850mm	3580 × 1320 × 1850mm
淨重/毛重 N.W. / G.W.	250 / 310kgs	250 / 310kgs

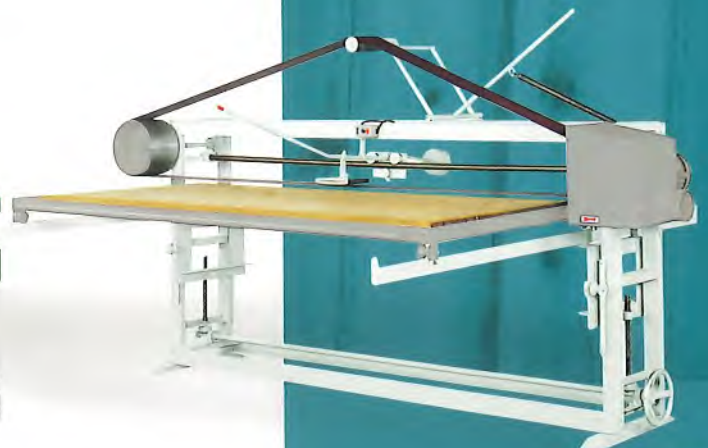

開邊式寬帶砂光機

WS-168 Open-Style Belt Sanding Machine

砂光寬度 Sanding width of work	381mm
砂光厚度 Sanding thickness of work	150mm
最短砂光長度 Min. length of work	350mm
砂帶尺寸 Sanding belt size	405 × 1372mm
砂帶驅動馬力 Sanding belt motor	7.5HP/3HP(5HP/1HP,10HP/3HP Options)
輸送帶馬力 Conveyor drive motor	1/8HP/3HP(1/4HP/1HP,1/4HP/3HP Options)
送料速度 Feed speed	6.2M/min
機械尺寸 Machine dimensions	930 × 900 × 1750mm
裝箱尺寸 Packing dimensions	1180 × 1150 × 2100mm
淨重/毛重 N.W. / G.W.	450 / 500kgs

雙帶、開邊式寬帶砂光機

WS-268 Two-Head Open-Style Wide Belt Sanding Machine

砂光寬度 Sanding width of work	381mm
砂光厚度 Sanding thickness of work	150mm
最短砂光長度 Min. length of work	350mm
砂帶尺寸 Sanding belt size	405 × 1372mm
砂帶驅動馬力 Sanding belt motor	7.5HP&5HP
輸送帶馬力 Conveyor drive motor	1/4HP
送料速度 Feed speed	6.2M/min
機械尺寸 Machine dimensions	1140 × 740 × 1720mm
裝箱尺寸 Packing dimensions	1390 × 990 × 2070mm
淨重/毛重 N.W. / G.W.	900 / 1050kgs

單軸多用途仿型砂光機 Single Head Multi-Purpose Copy Sanding Machine

	WS-1600	WS-2000
砂光馬達 Sanding drive motor	3HP Two speed	3HP Two speed
工作台馬達 Table drive motor	1HP DC motor	2HP DC motor
最大砂光尺寸 Max. sanding size	300 × 1600m/m	150 × 2000m/m
淨重/毛重 N.W. / G.W.	700 / 800kgs	900 / 1050kgs
機械尺寸 Machine size	156 × 156 × 178cm	185 × 200 × 150cm

立式圓棒砂光機

WS-JM Vertical Round Rod Sanding Machine

馬達轉速 Speed	1725R.P.M.
每分鐘震盪 Oscillations per minute	75
震盪高度 Length of oscillation	1 1/2"
工作台尺寸 Table size	610 × 610mm
工作台傾斜 Table tilt	0° - 45°
地板至工作高度 Table height from floor	37.4"(950mm)
馬達 Motor	1HP
淨重/毛重 N.W. / G.W.	137 / 145kgs
包裝尺寸 Packing dimensions	686 × 686 × 1168mm

立式線條砂光機

GB-900 Vertical Line Sanding Machine

驅動馬力 Spindle motor	3HP(4P / 2P), (5HP)
驅動轉速 Spindle speed	1200/2000/4400R.P.M.(2P) 600/1000/2200R.P.M.(4P)
機械尺寸 Machine dimensions	920 × 950 × 1080mm
裝箱尺寸 Packing dimensions	1170 × 1200 × 1430mm
淨重/毛重 N.W. / G.W.	220 / 330kgs



雙端海綿砂光機

GB-600D Double Side Sponge Drum Sanding Machine



海綿輪尺寸 Sponge drum size	Ø45/Ø60/Ø100 × 152 mm
砂帶尺寸 Sanding belt size	150 × 635 mm (6" × 25")
砂帶驅動馬力 Sanding belt motor	1 HP(4P)
砂帶轉速 Sanding belt speed	3段變速(3 speeds)
機械尺寸 Machine dimensions	950 × 560 × 920mm
裝箱尺寸 Packing dimensions	1200 × 810 × 1270mm
淨重 / 毛重 N.W. / G.W.	110 / 135 kgs

臥式曲型砂光機

GB-916 Horizontal Curve Sanding Machine



最大加工寬度 Max. width of work	300mm
砂光厚度範圍 Range of working thickness	9-100mm
砂帶尺寸 Sanding belt size	300 × 635mm(12" × 25")
砂帶驅動馬力 Sanding belt motor	2HP
送料馬力 Feed motor	1/8HP
砂帶轉速 Sanding belt speed	3段變速(3 speeds)
送料速度 Feed speed	3段變速(3 speeds)
機械尺寸 Machine dimensions	1160 × 600 × 1010mm
裝箱尺寸 Packing dimensions	1410 × 850 × 1360mm
淨重 / 毛重 N.W. / G.W.	170 / 280kgs

簡易型雙端海綿砂光機

GB-600DS Double Shaft Simple Sponge Sanding Machine



海綿輪尺寸 Sponge drum size	Ø45/Ø60/Ø100 × 152mm
砂帶尺寸 Sanding belt size	150 × 635 mm (6" × 25")
砂帶驅動馬力 Sanding belt motor	1 HP(2P/4P)
砂帶轉速 Sanding belt speed	2段變速(2 speeds)
機械尺寸 Machine dimensions	1000 × 420 × 960mm
裝箱尺寸 Packing dimensions	1250 × 670 × 1310mm
淨重 / 毛重 N.W. / G.W.	63 / 123kgs

氣鼓輪砂光機

GB-100 Irregular Curve Sanding Machine



棕刷輪 Abrasive brush wheel	4"
風輪砂帶 Sanding belt of air roller	9" × 13.5"
砂帶驅動馬力 Sanding belt motor	1HP (2P / 4P)
砂帶轉速 Sanding belt speed	2段變速(2 speeds)
機械尺寸 Machine dimensions	1000 × 420 × 960mm
裝箱尺寸 Packing dimensions	1250 × 670 × 1310mm
淨重 / 毛重 N.W. / G.W.	63 / 123kgs

橫式震盪砂光機 Horizontal Oscillating Sanding Machine



	GB-72A(2E)	GB-72B(2E)	GB-72C(2E)
最大砂光長度 Maximum length of work	915mm	1220mm	1525mm
最大加工高度 Maximum height of work	250mm	250mm	250mm
小平板尺寸 End table size	210 × 510mm	210 × 510mm	210 × 510mm
工作台面尺寸 Working table size	890 × 300mm	1200 × 300mm	1500 × 300mm
工作台傾斜角度 Working table tilt	45°	45°	45°
工作台調整高度 Working table adjustment height	5"	5"	5"
砂帶尺寸 Sanding belt size	10" × 114"	10" × 141"	10" × 160"
砂帶驅動馬力 Sanding belt motor	21M/sec	21M/sec	21M/sec
砂帶轉速 Sanding belt speed	3HP(2E:5HP)	5HP(2E:7 1/2HP)	5HP(2E:7 1/2HP)
機械尺寸 Machine dimensions	1650 × 750 × 1230mm	1990 × 750 × 1230mm	2250 × 850 × 1250mm
裝箱尺寸 Packing dimensions	1900 × 1000 × 1580mm	2240 × 1000 × 1580mm	2400 × 1000 × 1500mm
淨重 / 毛重 N.W. / G.W.	285 / 335kgs	385 / 435kgs	470 / 530kgs

橫式震盪砂光機

GB-728 Horizontal Oscillating Sanding Machine



最大砂光長度 Maximum length of work	1160mm
最大加工高度 Maximum height of work	190mm
砂帶尺寸 Sanding belt size	200 × 3125mm
砂帶驅動馬力 Sanding belt motor	3HP
砂帶轉速 Sanding belt speed	18.5M/sec
機械尺寸 Machine dimensions	1830 × 700 × 1230mm
裝箱尺寸 Packing dimensions	2080 × 950 × 1580mm
淨重 / 毛重 N.W. / G.W.	190 / 330kgs

多功能震盪砂光機

GB-935 Multi-Function Oscillating Edge Belt Sanding Machine



最大加工長度 Maximum length of work	600mm
最大加工高度 Maximum height of work	150mm
砂帶尺寸 Sanding belt size	150 × 2030mm
砂帶驅動馬力 Sanding belt motor	1 HP(2P)
砂帶轉速 Sanding belt speed	18.5M/sec
震盪馬力 Oscillation drive motor	25W
機械尺寸 Machine dimensions	1230 × 500 × 1100mm
裝箱尺寸 Packing dimensions	1480 × 750 × 1450mm
淨重 / 毛重 N.W. / G.W.	80 / 105kgs

GB-600D

GB-916

GB-600DS

GB-100

GB-72A/B/C(2E)

GB-728

GB-935



自動曲型砂光機 Automatic Sanding Machine for Curved Parts



	GB-800A	GB-800B
最大砂光高度 Max. height of work	150mm	300mm
砂光厚度範圍 Range of working thickness	9-100mm	9-100mm
砂帶尺寸 Sanding belt size	150×915mm(6"×36")	300×915mm(12"×36")
砂帶驅動馬力 Sanding belt motor	2HP	2HP
送料馬力 Feed motor	1/8 HP	1/8 HP
震盪馬力 Oscillation drive motor	25W	25W
砂帶轉速 Sanding belt speed	3段變速(3 speeds)	3段變速(3 speeds)
送料速度 Feed speed	3段變速(3 speeds)	3段變速(3 speeds)
機械尺寸 Machine dimensions	1070×760×1030mm	1070×760×1180mm
裝箱尺寸 Packing dimensions	1320×1050×1380mm	1320×1050×1530mm
淨重 / 毛重 N.W. / G.W.	285 / 355 kgs	305 / 375kgs



雙面自動曲型砂光機 Double Surface Automatic Sanding Machine for Curved Parts



	GB-800A2E	GB-800B2E
最小加工長度 Min. length of work	200mm	200mm
最大加工高度 Max. height of work	150mm	300mm
最大加工厚度 Max. thickness of work	100mm	100mm
砂帶驅動馬力 Sanding belt motor	2HP×2	2HP×2
砂帶尺寸 Sanding belt size	150×635mm (6"×25")	300×635mm (12"×25")
送料馬力 Feed motor	1/8HP×2	1/8HP×2
震盪馬力 Oscillation drive motor	25W×2	25W×2
砂帶轉速 Sanding belt speed	3段變速(3 speeds)	3段變速(3 speeds)
送料速度 Feed speed	3段變速(3 speeds)	3段變速(3 speeds)
機械尺寸 Machine dimensions	1200×1150×1100mm	1200×1150×1450mm
裝箱尺寸 Packing dimensions	1350×1300×1350mm	1350×1300×1700mm
淨重 / 毛重 N.G. / G.W.	380 / 490kgs	400 / 510kgs



四面直線邊砂光機 GB-B4P 4-Sides Linear Edge Sanding Machine



最大加工寬度 Max.workpiece width	100mm
最大加工高度 Max.workpiece height	150mm
最短加工長度 Min.workpiece length	300mm
砂帶尺寸 Sanding belt size	6"×36", 4"×36"
(B)環帶式砂光座 Motor drive of(B)sanding belt rounding unit	2HP×4
送料馬力 Feed motor	(1/4HP×1/40)×6
送料速度 Feed speed	變頻器無段變速
環帶式砂光座轉速 Sanding belt rounding unit speed	By variable speed of frequency inverter
機械尺寸 Machine dimensions	1300×1100×1600mm
裝箱尺寸 Packing dimensions	1500×1300×1900mm
淨重 / 毛重 N.W. / G.W.	320 / 450kgs



雙面震盪曲型砂光機 GB-919 Double surface oscillating curve sanding Machine



最大加工長度 Maximum length of work	1500mm
最大加工高度 Maximum height of work	150mm
最大加工厚度 Maximum thickness of work	100mm
砂帶驅動馬力 Sanding belt motor	2HP×2(4P/8P)
砂帶尺寸 Sanding belt size	150×915mm
送料馬力 Feed motor	1/8HP×4
震盪馬力 Oscillation drive motor	25W×2
砂帶轉速 Sanding belt speed	6段變速(6 speeds)
送料速度 Feed speed	3段變速(3 speeds)
機械尺寸 Machine dimensions	2400×1150×1280mm
裝箱尺寸 Packing dimensions	2650×1400×1630mm
淨重 / 毛重 N.W. / G.W.	750/900kgs

立式海綿砂光機

GB-450 Vertical Sponge Drum Sanding Machine



海綿輪尺寸 Sponge drum size	Ø45/Ø60/Ø100 × 152mm
砂帶尺寸 Sanding belt size	152 × 635mm(6" × 25")
驅動馬力 Sanding belt motor	1 HP(4P)
砂帶轉速 Sanding belt speed	3段變速(3 speeds)
機械尺寸 Machine dimensions	650 × 450 × 960mm
裝箱尺寸 Packing dimensions	900 × 700 × 1310mm
淨重/毛重 N.W. / G.W.	88 / 168kgs



GB-450

傾斜軸海綿砂光機

GB-315 Tilting Spindle Sponge Sanding Machine



海綿輪尺寸 Sponge drum size	Ø45/Ø60/Ø100 × 152mm
砂帶尺寸 Sanding belt size	152 × 635mm(6" × 25")
砂帶驅動馬力 Sanding belt motor	1HP(4P)
砂帶轉速 Sanding belt speed	3段變速(3 speeds)
機械尺寸 Machine dimensions	570 × 670 × 900mm
裝箱尺寸 Packing dimensions	820 × 920 × 1250mm
淨重/毛重 N.W. / G.W.	120 / 210kgs

GB-315



曲型圓棒砂光機

GB-160CS Curved Round Rod Sanding Machine



最小砂光直徑 Min.diameter of work	Ø10mm
最大砂光直徑 Max.diameter of work	Ø40mm
最小工件曲型 Min.curvature of work	R160mm
砂帶尺寸 Sanding belt size	30 × 586mm
砂帶驅動馬力 Sanding belt motor	2HP(4P)
圓盤驅動馬力 Disc drive motor	2HP(4P)
機械尺寸 Machine dimensions	500 × 650 × 1200mm
裝箱尺寸 Packing dimensions	750 × 900 × 1550mm
淨重 / 毛重 N.W. / G.W.	180 / 220kgs

GB-160CS



曲型圓棒砂光機

GB-262 Curved Round Rod Sanding Machine



砂光直徑範圍 Processing diameter	Ø13-20mm
最小工件曲型 Minimum curvature of work	R90mm
砂帶尺寸 Sanding belt size	13 × 262mm
砂帶驅動馬力 Sanding belt motor	1/2HP(4P)
機械尺寸 Machine dimensions	440 × 420 × 1160mm
裝箱尺寸 Packing dimensions	690 × 670 × 1510mm
淨重 / 毛重 N.W. / G.W.	72 / 122kgs

GB-262



多功能仿型磨邊砂光機

GB-116 Versatile Edge Copy Profile Sanding Machine



最大加工寬度 Max.workpiece width	1200mm
最大加工高度 Max.workpiece height	75mm
最小加工長度 Min.workpiece length	150mm
砂帶尺寸 Sanding belt size	75 × 2490mm (3" × 98")
頭部傾斜 Sanding head tilts	45°
砂帶驅動馬力 Sanding belt motor	2HP × 1
送料馬力 Feed motor	1/2HP × 1/20
送料速度 Feed speed	變頻器無段變速
砂帶轉速 Sanding belt speed	By variable speed of frequency inverter 變頻器無段變速
主軸式砂光座 Spindle type sanding head	1/2HP
機械尺寸 Machine dimensions	1620 × 1300 × 1350mm
裝箱尺寸 Packing dimensions	1870 × 1550 × 1700mm
淨重 / 毛重 N.W. / G.W.	420 / 540kgs

GB-116



多功能仿型砂光機

GB-880 Universal Copy Profile Sanding Machine



最大加工寬度 Max. workpiece width	1500mm
最大加工高度 Max. workpiece height	75mm
砂帶尺寸 Sanding belt size	75 × 2490mm (3" × 98")
頭部傾斜 Sanding head tilt	70° -190°
砂帶驅動馬力 Sanding belt motor	2HP × 1
送料馬力 Feed motor	1HP × 1/40
砂帶轉速 Sanding belt speed	變頻器無段變速
送料速度 Feed speed	By variable speed of frequency inverter 變頻器無段變速
真空馬力 Vacuum motor	3/4 HP
機械尺寸 Machine dimensions	1850 × 1950 × 1450mm
裝箱尺寸 Packing dimensions	2100 × 2200 × 1800mm
淨重 / 毛重 N.W. / G.W.	950 / 1200kgs

GB-880





GB-200 研磨輪成型機 Grinding Tool for Shaped Parts

砂輪機 Disc Grinder

四面直線仿型邊砂光機 GB-380PA7FT 4-Sides Linear & Profile Edge Sanding Machine



最大加工寬度 Max. workpiece width	150mm
最大加工高度 Max. workpiece height	75mm(100mm)
最短加工長度 Min. workpiece length	550mm
砂帶尺寸 Sanding belt	75mm × 2490mm (3" × 98")
砂帶尺寸(研磨底部) Sanding belt(bottom)	100mm × 1980mm (4" × 78")
頭部傾斜 Sanding head tilts	70° -190°
頭部傾斜(研磨底部) Sanding head tilts(bottom)	-10° -110°
(80)三角環帶式砂光座 Motor drive of(80) sanding belt	2HP × 3
(A)主軸式砂光座 Motor drive of(A) sanding wheel	2HP × 7
送料馬力 Feed motor	(1/4HP × 1/25) × 21
送料速度 Feed speed	3-38M/min, 變頻器無段變速
	By variable speed of frequency inverter
砂帶速度調整 Sanding belt speed control	變頻器無段變速
	By variable speed of frequency inverter
主軸式砂光座轉速 Sanding wheel speed	變頻器無段變速
	By variable speed of frequency inverter
機械尺寸 Machine dimensions	8850 × 2200 × 1500mm
裝箱尺寸 Packing dimensions	4600 × 1600 × 1900mm
淨重 / 毛重 N.W. / G.W.	5800 / 6000kgs

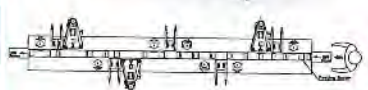

四面直線仿型邊砂光機 GB-480PA6FT-R 4-Sides Linear & Profile Edge Sanding Machine



最大加工寬度 Max. workpiece width	150mm
最大加工高度 Max. workpiece height	75mm(100mm)
最短加工長度 Min. workpiece length	550mm
砂帶尺寸 Sanding belt	75mm × 2490mm (3" × 98")
砂帶尺寸(研磨底部) Sanding belt(bottom)	100mm × 1980mm (4" × 78")
頭部傾斜 Sanding head tilts	70° -190°
頭部傾斜(研磨底部) Sanding head tilts(bottom)	-10° -110°
(80)三角環帶式砂光座 Motor drive of(80) sanding belt	2HP × 4
(A)主軸式砂光座 Motor drive of(A) sanding wheel	2HP × 6
送料馬力 Feed motor	(1/4HP × 1/25) × 19, (1/2HP × 1/25) × 1
送料速度 Feed speed	3-38M/min, 變頻器無段變速
	By variable speed of frequency inverter
砂帶速度調整 Sanding belt speed control	變頻器無段變速
	By variable speed of frequency inverter
主軸式砂光座轉速 Sanding wheel speed	變頻器無段變速
	By variable speed of frequency inverter
機械尺寸 Machine dimensions	9000 × 1650 × 1500mm
裝箱尺寸 Packing dimensions	9200 × 1850 × 1800mm
淨重 / 毛重 N.W. / G.W.	6000 / 6200kgs



T type can be sanded after molded finished at a time. T型結構具雙重功能，可將木料先四面成型後再砂光仿邊。



四面直線仿型邊砂光機 GB-380PA6FT 4-Sides Linear & Profile Edge Sanding Machine



最大加工寬度 Max. workpiece width	150mm
最大加工高度 Max. workpiece height	75mm(100mm)
最短加工長度 Min. workpiece length	550mm
砂帶尺寸 Sanding belt	75mm × 2490mm (3" × 98")
砂帶尺寸(研磨底部) Sanding belt(bottom)	100mm × 1980mm (4" × 78")
頭部傾斜 Sanding head tilts	70° -190°
頭部傾斜(研磨底部) Sanding head tilts(bottom)	-10° -110°
(80)三角環帶式砂光座 Motor drive of(80) sanding belt	2HP × 3
(A)主軸式砂光座 Motor drive of(A) sanding wheel	2HP × 6
送料馬力 Feed motor	(1/4HP × 1/25) × 18
送料速度 Feed speed	3-38M/min, 變頻器無段變速
	By variable speed of frequency inverter
砂帶速度調整 Sanding belt speed control	變頻器無段變速
	By variable speed of frequency inverter
主軸式砂光座轉速 Sanding wheel speed	變頻器無段變速
	By variable speed of frequency inverter
機械尺寸 Machine dimensions	8000 × 2100 × 1500mm
裝箱尺寸 Packing dimensions	8200 × 2300 × 1800mm
淨重 / 毛重 N.W. / G.W.	5800 / 6000kgs

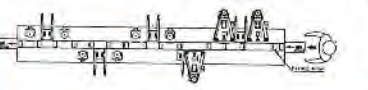

四面直線仿型邊砂光機 GB-480PA4FT 4-Sides Linear and Profile Edge Sanding Machine



最大加工寬度 Max. workpiece width	150mm
最大加工高度 Max. workpiece height	75mm(100mm)
最短加工長度 Min. workpiece length	550mm
砂帶尺寸 Sanding belt	75mm × 2490mm (3" × 98")
砂帶尺寸(研磨底部) Sanding belt(bottom)	100mm × 1980mm (4" × 78")
頭部傾斜 Sanding head tilts	70° -190°
頭部傾斜(研磨底部) Sanding head tilts(bottom)	-10° -110°
(80)三角環帶式砂光座 Motor drive of(80) sanding belt	2HP × 4
(A)主軸式砂光座 Motor drive of(A) sanding wheel	2HP × 4
送料馬力 Feed motor	(1/4H × 1/25) × 18
送料速度 Feed speed	3-38M/min, 變頻器無段變速
	By variable speed of frequency inverter
砂帶速度調整 Sanding belt speed control	變頻器無段變速
	By variable speed of frequency inverter
主軸式砂光座轉速 Sanding wheel speed	變頻器無段變速
	By variable speed of frequency inverter
機械尺寸 Machine dimensions	7500 × 1800 × 1500mm
裝箱尺寸 Packing dimensions	7700 × 2000 × 1800mm
淨重 / 毛重 N.W. / G.W.	5500 / 5700kgs



四面直線仿型邊砂光機 GB-A6FT-R 4-Sides Linear and Profile Edge Sanding Machine



最大加工寬度 Max. workpiece width	150mm
最大加工高度 Max. workpiece height	75mm(100mm)
最短加工長度 Min. workpiece length	550mm
頭部傾斜 Sanding head tilts	70° -190°
(A)主軸式砂光座 Motor drive of(A) sanding wheel	2HP × 6
送料馬力 Feed motor	(1/4HP × 1/25) × 10, (1/4HP × 1/25) × 1
送料速度 Feed speed	3-38M/min, 變頻器無段變速
	By variable speed of frequency inverter
主軸式砂光座轉速 Sanding wheel speed	變頻器無段變速
	By variable speed of frequency inverter
機械尺寸 Machine dimensions	6150 × 1800 × 1500mm
裝箱尺寸 Packing dimensions	6350 × 2000 × 1800mm
淨重 / 毛重 N.W. / G.W.	4000 / 4200kgs

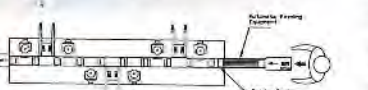

直線仿型邊砂光機

GB-280PA1FS

Single Side Linear & Profile Edge Sanding Machine



最大加工寬度 Max.workpiece width	1500mm
最大加工高度 Max.workpiece height	75mm(100mm)
最短加工長度 Min.workpiece length	200mm
砂帶尺寸 Sanding belt	75mm × 2490mm (3" × 98")
頭部傾斜 Sanding head tilts	70° -190°
(80)三角環帶式砂光座 Motor drive of(80) sanding belt	2HP × 2
(A)主軸式砂光座 Motor drive of(A) sanding wheel	2HP × 1
送料馬力 Feed motor	3HP
送料速度 Feed speed	3-30M/min, 變頻器無段變速
砂帶速度調整 Sanding belt speed control	By variable speed of frequency inverter 變頻器無段變速
主軸式砂光座轉速 Sanding wheel speed	By variable speed of frequency inverter 變頻器無段變速
機械尺寸 Machine dimensions	By variable speed of frequency inverter 3700 × 1400 × 1600mm
裝箱尺寸 Packing dimensions	3900 × 1600 × 1900mm
淨重 / 毛重 N.W. / G.W.	2400 / 2600kgs

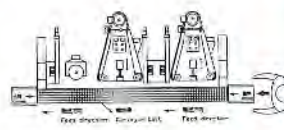

砂輪機 Disc Grinder



GB-200 研磨輪成型機 Grinding Tool for Shaped Parts

直線仿型邊砂光機

GB-380PA1FS

Single Side Linear & Profile Edge Sanding Machine



最大加工寬度 Max.workpiece width	1500mm
最大加工高度 Max.workpiece height	75mm(100mm)
最短加工長度 Min.workpiece length	200mm
砂帶尺寸 Sanding belt	75mm × 2490mm (3" × 98")
頭部傾斜 Sanding head tilts	70° -190°
(80)三角環帶式砂光座 Motor drive of(80) sanding belt	2HP × 3
(A)主軸式砂光座 Motor drive of(A) sanding wheel	2HP × 1
送料馬力 Feed motor	3HP
送料速度 Feed speed	3-30M/min, 變頻器無段變速
砂帶速度調整 Sanding belt speed control	By variable speed of frequency inverter 變頻器無段變速
主軸式砂光座轉速 Sanding wheel speed	By variable speed of frequency inverter 變頻器無段變速
機械尺寸 Machine dimensions	By variable speed of frequency inverter 4700 × 1400 × 1600mm
裝箱尺寸 Packing dimensions	4900 × 1600 × 1900mm
淨重 / 毛重 N.W. / G.W.	2550 / 2750kgs

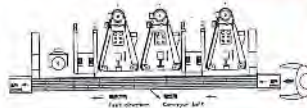

*Profile shapers & sanding wheel can be flexible tilt to perform the irregular surface. 仿型頭及砂光輪可彈性調整，可成型及砂光工作物不規則面。

直線仿型邊砂光機

GB-A2FC2S

Single Side Linear & Profile Edge Sanding Machine



最大加工寬度 Max.workpiece width	1500mm
最大加工高度 Max.workpiece height	75mm(100mm)
最短加工長度 Min.workpiece length	200mm
砂帶尺寸 Sanding belt	75mm × 2490mm (3" × 98")
頭部傾斜 Sanding head tilts	70° -190°
(A)主軸式砂光座 Motor drive of(A) sanding wheel	2HP × 2
(C)仿型鉋光座 Moulding head	7 1/2HP × 2
送料馬力 Feed motor	2HP
送料速度 Feed speed	3-30M/min, 變頻器無段變速
主軸式砂光座轉速 Sanding wheel speed	By variable speed of frequency inverter 變頻器無段變速
鉋光座轉速 Moulding speed	By variable speed of frequency inverter 6000-7800R.P.M.
機械尺寸 Machine dimensions	3950 × 1400 × 1600mm
裝箱尺寸 Packing dimensions	4150 × 1600 × 1900mm
淨重 / 毛重 N.W. / G.W.	2200 / 2400kgs

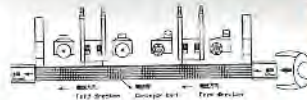

直線仿型邊砂光機

GB-280PA3FC2S

Single Side Linear & Profile Edge Sanding Machine



最大加工寬度 Max.workpiece width	1500mm
最大加工高度 Max.workpiece height	75mm(100mm)
最短加工長度 Min.workpiece length	200mm
砂帶尺寸 Sanding belt	75mm × 2490mm(3" × 98")
頭部傾斜 Sanding head tilts	70° -190°
(80)三角環帶式砂光座 Motor drive of(80) sanding belt	2HP × 2
(A)主軸式砂光座 Motor drive of(A) sanding wheel	2HP × 3
(C)仿型鉋光座 Motor drive of(C)moulding head	7 1/2HP × 2
送料馬力 Feed motor	7 1/2HP
送料速度 Feed speed	3-30M/min, 變頻器無段變速
砂帶速度調整 Sanding belt speed control	By variable speed of frequency inverter 變頻器無段變速
主軸式砂光座轉速 Sanding wheel speed	By variable speed of frequency inverter 變頻器無段變速
鉋光座轉速 Moulding speed	By variable speed of frequency inverter 6000-7800R.P.M.
機械尺寸 Machine dimensions	6900 × 1400 × 1600mm
裝箱尺寸 Packing dimensions	7100 × 1600 × 1900mm
淨重 / 毛重 N.W. / G.W.	4000 / 4200kgs

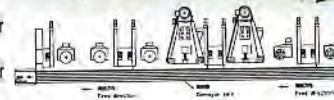

*Molding cutters can be skipped to shape work-piece, avoid tearing the ends of shaped parts while mold 4 sides of solid woods. 鉋刀具跳刀功能，成型實木四面時，防止仿邊被撕裂。

PANEL SAW 裁板機



SM-10PCL 裁板機 Panel Saw

鋸切能力 CAPACITY	
鋸切長度 Maximum length of cut	3520mm
鋸切厚度 Maximum depth of cut	120mm
主鋸片 MAIN SAWBLADE	
主鋸片直徑 Main blade diameter	Ø450mm
鋸軸直徑 Arbor diameter	Ø60mm
主鋸軸轉速 Main blade arbor speed	3910R.P.M.
副鋸片 SCORING SAWBLADE	
鋸片直徑 Blade diameter	Ø180mm
鋸軸直徑 Arbor diameter	Ø45mm
副鋸片轉速 Scoring blade arbor speed	5100R.P.M.
鋸座 SAW CARRIAGE	
前進行程速度 Feed forward speed	80M/min
後退速度 Retract speed	120M/min
馬達 MOTOR	
主鋸片驅動馬達 Main sawblade motor	18HP
副鋸片馬達 Scoring sawblade motor	3HP
鋸座驅動馬達 Saw carriage drive motor	1.5HP
其他 OTHERS	
自動送料系統 Automatic feed system	3.5kw(AC serve)
自動送料速度 Automatic panel feed speed	80M/min
使用氣壓 Working air pressure	7kg/cm ²
工作檯離地高度 Table height from floor	1020mm

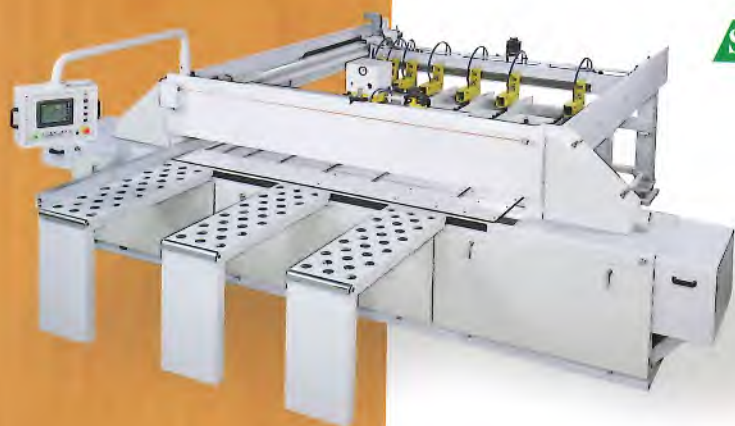

SM-10AG-N 裁板機 Panel Saw

最大鋸切厚度 Max. depth of cut	70 / 95mm
最大鋸切長度 Max. length of cut	3200mm
鋸片馬達 Sawblade motor	13HP
鋸座馬達 Saw carriage feed motor	2HP
送料座馬達 Auto feed motor	1kw
送料座速度 Auto panel feed speed	0-30M/min
鋸座速度 Saw carriage feed speed	15, 20, 25M/min
操作氣壓 Working air pressure	5.5-6kg/cm ²
空氣消耗量 Air consumption	35-40l/min
吸塵量 Dust suction speed	20-25m ³ /sec
主鋸片直徑 Main sawblade diameter	14"/16"
副鋸片直徑 Scoring sawblade diameter	180mm
主鋸軸 Main sawblade arbor	1"
副鋸軸 Scoring sawblade arbor	1"



SM-10 裁板機 Panel Saw

鋸切長度 Maximum length of cut	3250mm
鋸切厚度 Maximum depth of cut	80mm
主鋸片 MAIN SAWBLADE	
主鋸片直徑 Main blade diameter	Ø355mm
鋸軸直徑 Arbor diameter	Ø1"
主鋸軸轉速 Main blade arbor speed	4800R.P.M.
小鋸片直徑 Scoring small blade diameter	Ø160mm
副鋸片 SCORING SAWBLADE	
鋸軸直徑 Arbor diameter	Ø1"
副鋸片轉速 Scoring blade arbor speed	6500R.P.M.
鋸座 SAW CARRIAGE	
前進行程速度 Feed forward speed	12-16-21-26M/min
後退速度 Retract speed	24-32-42-52M/min
馬達 MOTOR	
主鋸片驅動馬達 Main sawblade motor	13HP
鋸座驅動馬達 Saw carriage drive motor	3HP
其他 OTHERS	
自動送料速度 Automatic panel feed speed	40M/min
淨重 Net weight	2400kgs
毛重 Gross weight	2900kgs
機械尺寸 Machine dimensions	230" × 132" × 72"
裝箱尺寸 Packing dimensions	232" × 40" × 63"

SM-2800TM 裁板機 Sliding Table Saw

推抬尺寸 Sliding table dimension	380 × 2800mm
鋸切長度 Length of cut	2800mm
主鋸片 MAIN SAW	
主軸鋸片 Sawblade	Max. Ø350mm
主鋸軸 Sawblade Bore	Ø30(or Ø25.4)mm
90° 鋸切厚度 Depth of cut of 90°	100mm
45° 鋸切厚度 Depth of cut of 45°	70mm
主鋸馬達 Motor power	7.5HP(option 10HP)
主鋸轉速 Spindle speed	3000/4000/5000/6000R.P.M.
傾斜角度 Tilting saw blade	0-45°
副鋸片 SCORING	
副軸鋸片 Sawblade	Ø120mm
副鋸軸 Sawblade Bore	Ø22mm
副鋸馬達 Motor power	1 HP
副鋸轉速 Spindle speed	8000R.P.M.
傾斜角度 Tilting saw blade	0-45°
鋸切寬度 Cutting width	1000(option 1300, 1500)mm
裝箱尺寸 Packing	2060 × 1180 × 1020
淨重/毛重 N.W. / G.W.	450 × 280 × 2850mm 850 / 1000kgs

單排鑽孔機 Single Unit Boring Machine

ABM HWA SHIN

	HS-21T	HS-27T	HS-35T
軸心間距 Max. distance between center	32mm	32mm	32mm
主軸數 Number of spindle per boring head	21	27	35
最大鑽孔深度 Max. drilling depth	80mm	80mm	80mm
最大鑽孔高度 Max. height of bore	65mm	65mm	65mm
工作台面尺寸 Table size	872×490mm	1070×490mm	1325×490mm
主軸轉速 Spindle speed	2800R.P.M.	2800R.P.M.	2800R.P.M.
馬達 Motor	2.5HP	2.5HP	2.5HP×2
淨重/毛重 N.W. / G.W.	350 / 430kgs	400 / 480kgs	550 / 680kgs
機械尺寸 Machine size	968×820×1220mm	1220×820×1370mm	1470×820×1250mm
包裝尺寸 Packing size	1143×889×1372mm	1270×889×1372mm	1550×889×1372mm

*機種規格形狀若有變更，恕不另行通知。 Specifications subject to change without prour notice.



雙排鑽孔機 Two Unit Boring Machine

ABM HWA SHIN

	HS-27T2
軸心間距 Max. distance between center	32mm
鑽頭主軸數 Number of spindle per boring head	27+27
最大鑽孔深度 Max. drilling depth	80mm
最大鑽孔高度 Max. height of bore	65mm
工作台面尺寸 Table size	1070×490mm
主軸轉速 Spindle speed	2800R.P.M.
馬達 Motor	2.5HP×2
淨重/毛重 N.W. / G.W.	550 / 650kgs
機械尺寸 Machine size	1220×820×1370mm
包裝尺寸 Packing size	1422×889×1702mm

*機種規格形狀若有變更，恕不另行通知。 Specifications subject to change without prour notice.



三排鑽孔機 Three Unit Boring Machine

ABM HWA SHIN

	HS-63T
軸心間距 Max. distance between center	32mm
鑽頭主軸數 Number of spindle per boring head	21+21+21
最大鑽孔深度 Max. drilling depth	80mm
馬達 Motor	2HP×3
主軸轉速 Spindle speed	2800R.P.M.
淨重/毛重 N.W. / G.W.	620 / 730kgs
機械尺寸 Machine size	2000×1260×1300mm
包裝尺寸 Packing size	2235×1320×1575mm

*機種規格形狀若有變更，恕不另行通知。 Specifications subject to change without prour notice.



六排鑽孔機 Six Unit Boring Machine

ABM HWA SHIN

	HS-114T
軸心間距 Max. distance between center	32mm
主軸數 Number of horizontal boring head spindles per head	21×2
垂直(主軸數) Number of vertical boring head spindles per head	(11×2)×4
馬達 Power of motors	2.5HP×10
立軸座最小距離 Min distance vertical heads	150mm
立軸座最大距離 Max. distance vertical heads	2400mm
主軸轉速 Spindle speed	2800R.P.M.(50Hz) / 3300R.P.M.(60Hz)
壓料座 Pneumatic clamps	2
鑽孔深度 Adjustment boring depth	0-65mm
淨重/毛重 N.W. / G.W.	2400 / 2600kgs
包裝尺寸 Packing size	3810×1940×1850mm

*4 sets of vertical boring unit can be optional until 7 sets in one machine. 垂直站座可追加至7座。





直線排鑽機 Line Boring Machine

ABM HWA SHIN

	HS-A15	HS-A21
馬達 Motor	2HP	2.5HP
工作檯面 Table size	510 × 1200mm	510 × 1200mm
最大工作厚度 Max. drilling depth	80mm	80mm
排鑽軸心距離 Max. Distance between center	32mm	32mm
壓縮空氣 Compress air required	6-8kg/cm ²	6-8kg/cm ²
排鑽軸心數 Number of spindle per boring head	15	21
淨重/毛重 N.W. / G.W.	140 / 190kgs	150 / 200kgs
機械尺寸 Machine size	1200 × 700 × 1520mm	1200 × 700 × 1520mm
包裝尺寸 Packing size	1500 × 838 × 1778mm	1500 × 838 × 1778mm



HS-310 水平鑽孔機 Horizontal Boring Machine

ABM HWA SHIN

馬達 Motor standard	3HP
主軸轉速 Spindle speed	2900R.P.M.
鑽頭尺寸 Drill bit size	(M8 or M10) × 32mm × 3holes
行程 Stroke distance	0-80mm
工作檯面尺寸 Table size	290 × 285mm
機械尺寸(有腳座) Machine size with stand	1076 × 483 × 1076mm
機械尺寸(無腳座) Machine size w/o stand	1016 × 381 × 711mm
包裝尺寸 Packing size	1118 × 521 × 1118mm
淨重/毛重 N.W. / G.W.	150 / 170kgs



水平鑽孔機 Horizontal Boring Machine

ABM HWA SHIN

	HS-524	HS-526
主軸馬達 H Spindle motor	3HP × 1	3HP × 2
主軸行程 H. Spindle travel	100mm	100mm
主軸數 Number of H spindle	6	10
壓料器 Number of hold down clamp	3	4
軸心轉速 Spindle speed	2800R.P.M./50Hz, 3500R.P.M./60Hz	2800R.P.M./50Hz, 3500R.P.M./60Hz
最大深度 Max. boring height	90mm	90mm
最小軸距 Man. distance between	HS150mm / HS240mm	HS150mm / HS240mm
工作檯面尺寸 Table size	380 × 1260mm	380 × 1860mm
機械尺寸 Machine size	1280 × 1280 × 1200mm	1860 × 1380 × 1200
包裝尺寸 Packing size	1380 × 1480 × 1350mm	1880 × 1480 × 1360mm
淨重/毛重 N.W. / G.W.	700 / 900kgs	900 / 1150kgs



單頭鑽孔機 Horizontal & Vertical Spindle Boring Machine

ABM HWA SHIN

	HS-501	HS-501+R
馬達 Motor	3HP	Hor.:3HP × 1, Ver.:1HP × 1
工作檯面尺寸 Table size	390 × 560mm	390 × 560mm
鑽頭尺寸 Drill bit size	(M8 or M10) × 32mm × 5holes	Hor.:(M8 or M10) × 32mm × 5holes, Ver.:Chuck 13mm
行程 Stroke distance	0-60mm	0-80mm
機械尺寸 Machine size	1020 × 760 × 1470mm	1180 × 755 × 1570mm
包裝尺寸 Packing size	1245 × 940 × 1780mm	1397 × 940 × 1780mm
淨重/毛重 N.W. / G.W.	420 / 500kgs	480 / 560kgs

雙頭鑽孔機

HS-502 Double Spindle Boring Machine

ABM HWA SHIN

馬達 Motor	3HP × 2
主軸轉速 Spindle speed	3400rpm/60Hz, 2800rpm/50Hz
鑽頭尺寸 Boring head	M8 × 1.25mm or M10 × 1.5mm
行程 Stroke distance	0-80mm
最大工作物長度 Max. working length	2100mm(Opposite), 2900mm(Parallel)
壓力 Pressure	55kg/cm ²
裝箱尺寸 Packing size	3200 × 1040 × 1320mm
淨重/毛重 N.W. / G.W.	650 / 850kgs



雙頭水平、垂直鑽孔機

HS-502+2R Dowel Boring Machine

ABM HWA SHIN

馬達 Motor	3HP × 2, 1HP × 2
鑽頭尺寸 Drill bit size	Hor.: (M8 or M10) × 32mm × 5holes / Ver.: Chuck
行程 Stroke distance	0-80mm
最大工作物長度 Max. working length	2100mm(Opposite), 2900mm(Parallel)
主軸轉速 Spindle speed	3400R.M.P./60Hz, 2800R.P.M./50Hz
機械尺寸 Machine size	3100 × 1030 × 1150mm
包裝尺寸 Packing size	3200 × 1040 × 1320mm
淨重/毛重 N.W. / G.W.	770 / 970kgs



六頭鑽孔機

HS-506 Spindle Boring Machine

ABM HWA SHIN

馬達 Motor	3HP × 6
鑽頭尺寸 Drill bit size	(M8 or M10) × 32mm × 5holes
行程 Stroke distance	0-80mm
最大工作物長度 Max. working length	2100mm(Opposite), 2900mm(Parallel)
壓力 Pressure	55kg/cm ²
主軸轉速 Spindle speed	3400R.P.M./60HZ, 2800R.P.M./50HZ
包裝尺寸 Packing size	3200 × 1040 × 1320mm 3200 × 1160 × 1320mm
淨重 N.W.	2310 / 1050kgs
毛重 G.W.	2750 / 1250kgs



曲木鑽孔機

HS-C6 Curved-Wood Drilling Machine

ABM HWA SHIN

馬達 Motor	2HP × 2
主軸轉速 Spindle speed	2000R.P.M.
鑽頭夾數 Drill chuck	12m/m
主軸數 Number of spindle	6
機械尺寸 Machine size	1050 × 1000 × 1010mm
包裝尺寸 Packing size	1651 × 914 × 1143mm
淨重/毛重 N.W. / G.W.	650 / 780kgs





油壓立式多軸鑽孔機 Multiple Spindle Drilling Machine **ABM HWA SHIN**

	HS-810	HS-812	HS-816
馬達 Motor	3HP×2	3HP×3	3HP×3
行程 Max. table travel	100(4)"	100(4)"	100(4)"
工作台面尺寸 Table size	600×1800mm	600×2400mm	900×1800mm
主軸數 Number of spindle	12	16	16
墮輪數 Idler wheel	8pcs	10pcs	10pcs
壓料數 Hold-down clamp	6pcs	8pcs	8pcs
油壓馬達 Hydraulic motor	2HP	2HP	2HP
包裝尺寸 Packing size	2006×1575×1730mm	2600×1550×1730mm	2000×1900×1130mm
淨重/毛重 N.W. / G.W.	1050 / 1250kgs	1300 / 1550kgs	1300 / 1550kgs



HS-604 四軸椅面座鑽頭機 Seat Drilling Machine **ABM HWA SHIN**

馬達 Motor	1HP×4
工作台面積 Table area	1200×910×760mm
機械尺寸 Machine size	1200×910×1500mm
包裝尺寸 Packing size	1320×990×1727mm
淨重/毛重 N.W. / G.W.	730 / 850kgs



HS-608 四軸椅面座鑽頭機 Seat Drilling Machine **ABM HWA SHIN**

馬達 Motor	1HP×8
行程 Stroke travel	80mm
鑽頭轉速 Speed of drill	2000R.P.M.
機械尺寸 Machine size	1400×910×1600mm
包裝尺寸 Packing size	1473×990×1828mm
淨重/毛重 N.W. / G.W.	900 / 1100kgs



橫式雙端鑽孔機 Horizontal Twin Head Boring Machine **YUAN LUNG**

	YL-372	YL-375	YL-377
主軸馬達 Spindle motor	2HP×2	2HP×2	2HP×2
主軸轉速 Spindle speeds	3600R.P.M.	3600R.P.M.	3600R.P.M.
主軸最大鑽深 Max. boring depth of spindle	80mm	80mm	80mm
主軸行程 Stroke travel	80mm	80mm	80mm
主軸旋轉 Swivel adjustment for spindle	360°(Omnibearing)	360°(Omnibearing)	360°(Omnibearing)
加工物最大長度 Max. length of workpiece (feet)	2.5	5	7
機械尺寸 Machine size (feet)	6×2.3×5mm	8.5×2.3×5mm	10.5×2.3×5mm
淨重/毛重 N.W. / G.W.	600 / 650kgs	600 / 650kgs	600 / 650kgs



四軸鑽孔機 Four Spindle Drilling Machine **YUAN LUNG**

	YL-385	YL-387	YL-388
橫主軸馬力 Horizontal spindle motor	2HP×2	2HP×2	2HP×2
立主軸馬力 Vertical spindle motor	2HP×2	2HP×2	2HP×2
主軸轉速 Spindle speeds	3600R.P.M.	3600R.P.M.	3600R.P.M.
橫主軸最大鑽深 Max. boring depth of horizontal spindle	80mm	80mm	80mm
橫主軸行程 Stroke travel of horizontal spindle	80mm	80mm	80mm
橫主軸旋轉 Swivel of horizontal spindle	360°(Omnibearing)	360°(Omnibearing)	360°(Omnibearing)
立主軸最大鑽深 Max. boring depth of vertical spindle	80mm	80mm	80mm
立主軸行程 Stroke travel of vertical spindle	80mm	80mm	80mm
立主軸旋轉 Swivel adjustment for vertical spindle	360°(Omnibearing)	360°(Omnibearing)	360°(Omnibearing)
加工物最大長度 Max. length of workpiece (feet)	5	7	8
機械尺寸 Machine size	8.5×2.3×5.5mm	10.5×2.3×5.5mm	11.5×2.3×5.5mm
淨重/毛重 N.W. / G.W.	1100 / 1150kgs	1100 / 1150kgs	1100 / 1150kgs

簡易手壓鑽孔機

BD-430 Drilling Machine

速度 Spindle speeds	4
鑽孔能力 Drilling capacity	13mm-1/2"
旋徑 Swing	360
主軸至床面距離 Distance from spindle nose to table	480
主軸至底面距離 Distance from spindle nose to base	650
主軸斜度 Taper of spindle	JT#2 1/2
主軸行程 Travel of spindle	80
主軸回轉速 SPINDLE SPEED	
50 cycle	460-2040R.P.M.
60 cycle	560-2450R.P.M.
圓柱直徑 Diameter of colum	Ø80
床面面積 Table dimension	Ø320
底座面積 Base dimension	505 × 305
機械總高 Over high	1050
使用馬力 Motor	1/4HP 4P or 1/2HP 4P
淨重 N.W.	69kgs
包裝/才積 Packing size / cuft	890 × 525 × 355/5.9

簡易氣壓鑽孔機

BD-036 Vertical Automatic Boring Machine

動力 Power	1HP / 3PH
回轉速 Running speed	3440R.P.M. / 60Hz
行程 Stroke	80mm(3 1/8")
淨重 N.W.	61kg(134lb)

簡易鑽孔座

BD-101A Universal Boring Unit

動力 Power	1HP / 3PH
回轉速 Running speed	3440R.P.M. / 60Hz
行程 Stroke	80mm(3 1/8")
淨重 N.W.	42kg(96lb)

簡易鑽孔座

BD-101B Universal Boring Unit

動力 Power	1HP / 3PH
回轉速 Running speed	2000R.P.M. / 60Hz
行程 Stroke	80mm(3 1/8")
淨重 N.W.	38kg(86lb)

簡易鑽孔座

BD-101C Universal Boring Unit

動力 Power	1HP / 3PH
回轉速 Running speed	2000R.P.M. / 60Hz
行程 Stroke	80mm(3 1/8")
淨重 N.W.	27kg(59lb)

BD-430



BD-036



BD-101A

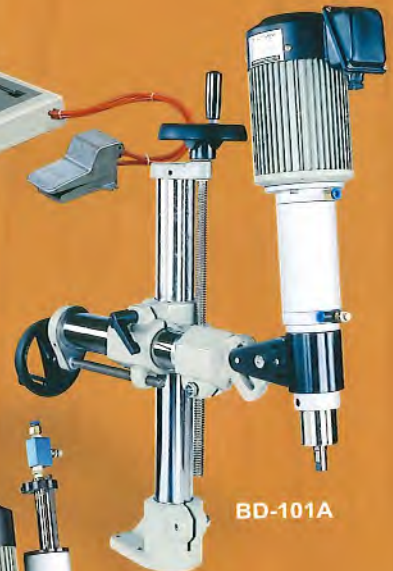

BD-101B



BD-101C

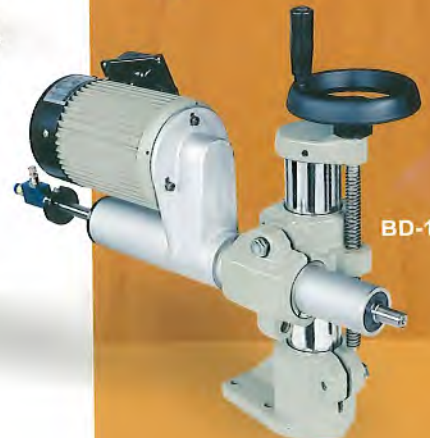

BANDING MACHINE 貼邊機



ED-1 手動貼邊機
Manual Edge Banding Machine

工作件長度 Workpiece length	160mm-unlimited
工作件寬度 Workpiece width	50mm-unlimited
工作件厚度 Workpiece thickness	8-50mm
邊材厚度 Edging thickness	0.3-1.2mm
進給馬力 Total power	1/4HP Variable speed or 1/2HP four speeds
淨重/毛重 N.W. / G.W.	250 / 320kgs
機械尺寸 Machine size	1250×950×1100mm
裝箱尺寸 Packing size	1520×880×1070mm



ED-3 基本型手動貼邊機
Edge Banding Machine

工作件長度 Panel length	160mm-up
工作件寬度 Panel width	50mm-up
工作件厚度 Panel thickness	8-55mm
邊裁厚度 Edging thickness	0.3-3mm
送材速度 Feed speed	9/14/21mpm
馬力 Power	1HP
淨重/毛重 Weight N.W. / G.W.	290 / 360kgs
機械尺寸 Size of machine	1220×920×1200mm
裝箱尺寸 Size of packing	1520×850×1000mm

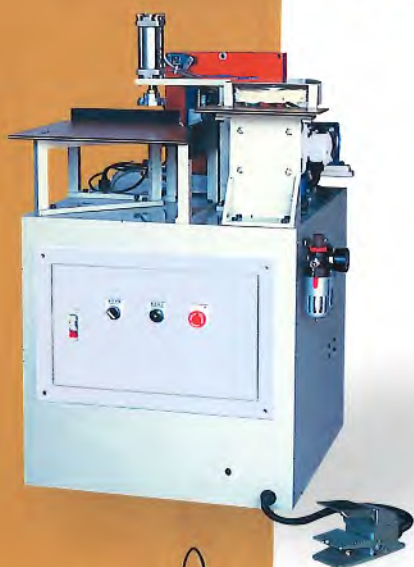

ED-5 手動緣角邊邊機
Profile Trimming Machine

工作件長度 Panel length	120mm-up
工作件寬度 Panel width	120mm-up
工作件厚度 Panel thickness	10-40mm
邊材厚度 Edging thickness	0.3-5mm
最大加工深度 Soft forming profile depth	50mm
馬力 Edge trimming power	0.5kw
拋光馬力 Buffing unit power	0.5HP
淨重/毛重 Weight N.W. / G.W.	180 / 250kgs
機械尺寸 Size of machine	750×750×1120mm
包裝尺寸 Size of packing	900×870×1350mm



ED-2 手動修邊機
Manual Edge Banding Machine

工作件長度 Workpiece length	160mm-unlimited
工作件寬度 Workpiece width	50mm-unlimited
工作件厚度 Workpiece thickness	10-55mm
邊材厚度 Edging thickness	0.3-5mm
進給馬力 Total power	0.5HP×2
淨重/毛重 N.W. / G.W.	180 / 250kgs
機械尺寸 Machine size	1000×750×1180mm
裝箱尺寸 Packing size	1100×900×1300mm

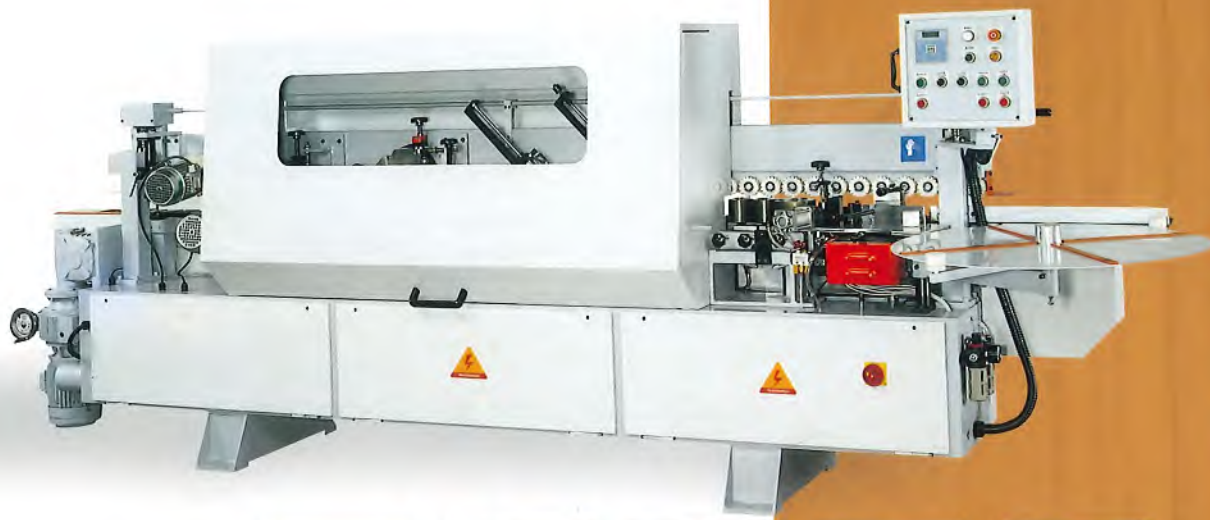

ED-320 自動封邊機
Automatic Edge Banding Machine

工件長度 Panel length	160mm-up
工件寬度 Panel width	65mm-up
工件厚度 Panel thickness	10-60mm
邊材厚度 Edging thickness	0.4-6mm/(10)
進給速度 Variable feed speed	5-28m/min
電源壓力 Air pressure required	6kg/cm ²
淨重/毛重 N.W. / G.W.	1350 / 1580kgs
機械尺寸 Machine size	4450 × 1200 × 1480mm
包裝尺寸 Packing size	4450 × 900 × 1710mm

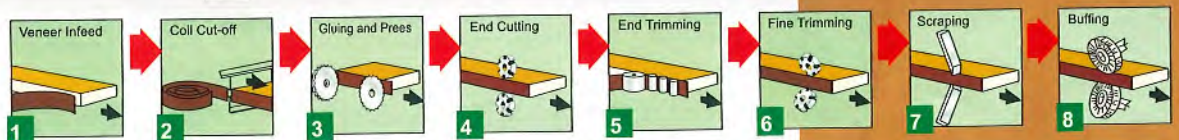
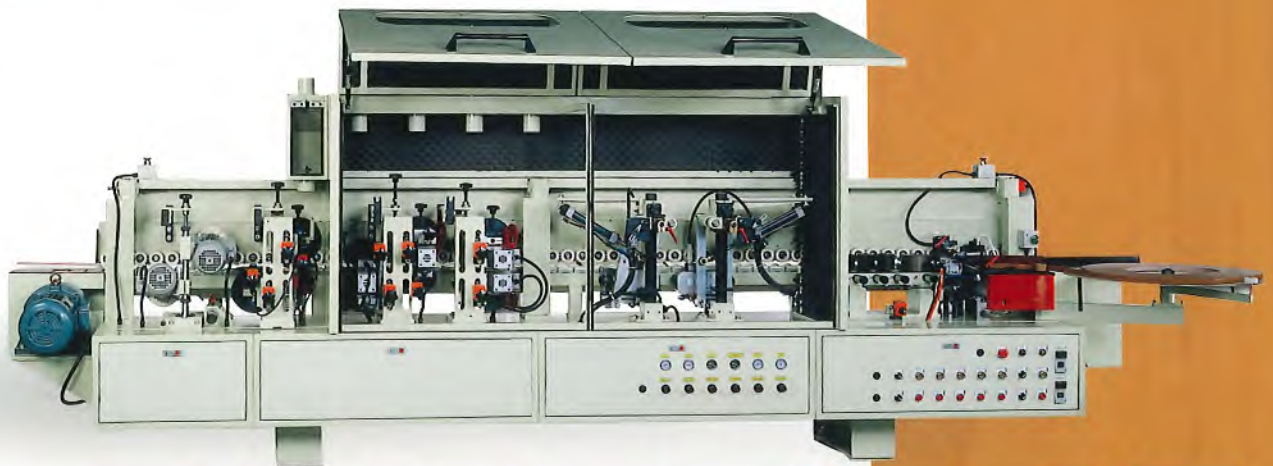

ED-500C 自動貼邊修邊機
Automatic Edge Banding Machine

工作長度 Workpiece length	160mm-up
工作寬度 Workpiece width	65mm-up
工作厚度 Workpiece thickness	10-60mm
邊材厚度 Edging thickness	0.4-6mm/(13)
膠桶容量 Glue pot	4kg
功率 Heating element HEAT	0.5+0.8+1=2.3kw
輸送帶馬力 Feed power	1.5kw-4kw
進給速度 Feed speed	6-25m/min
空氣壓力 Air pressure required	6kg/cm ²

GRINDER 磨刀機



錫鋼刀磨刀機 GM-200 Carbide Tipped Grinder

砂輪規格 Grinding wheel size	Ø150 × 16mm
砂輪迴轉速 Grinding wheel speed	3400R.P.M.
砂輪馬達 Grinding wheel motor	1HP
馬達冷卻泵浦 Coolant pump motor	1/8HP
機械尺寸 Machine size	800 × 850 × 1380mm
裝箱尺寸 Packing size	1000 × 1000 × 1480mm
淨重/毛重 N.W. / G.W.	280 / 360kgs

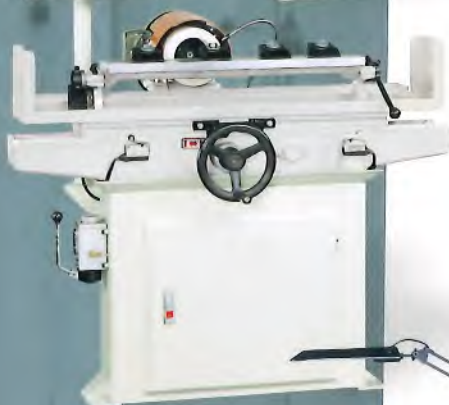

重切削直刀磨刀機 GM-500 Straight Knife Grinder

刀具尺寸 Coarse capacity	660 × 126 × 16mm
磨砂輪尺寸 Coarse grinding wheel size	Ø150 × 90 × 90mm
砂輪迴轉速 Grinding wheel speed	3400R.P.M.
粗磨砂輪馬達 Coarse wheel motor	2HP
減速機馬達 Table travel motor	1/4HP
冷卻幫浦馬達 Coolant pump motor	1/8HP
機械尺寸 Machine size	1150 × 750 × 1350mm
裝箱尺寸 Packing size	1240 × 880 × 1540mm
淨重/毛重 N.W. / G.W.	290 / 370kgs



圓鋸片磨刀機 GM-280 Circular Saw Grinder

磨刀能力 Grinding capacity	(最小 × 最大) Ø76 × 600mm
砂輪規格 鑽石砂輪 Grinding wheel size	Ø150 × Ø16mm
砂輪迴轉數 Speed of grinding wheel	4000R.P.M.
馬達砂輪 Motor grinding wheel	1/2HP
馬達砂輪偏轉 Eccentric motor	40W
馬達冷卻泵浦 Cooling system	1/8HP
機械尺寸 Machine size	1120 × 710 × 1270mm
裝箱尺寸 Packing size	1240 × 880 × 1540mm
機械重量 Net weight	400kgs
裝箱重量 Gross weight	490kgs



捨棄式刀片磨刀機 GM-240 Grinder for Throw-Away Knife

砂輪迴轉速 Grinding wheel speed	3400R.P.M.
砂輪馬達 Grinding wheel motor	1HP
砂輪規格 Grinding wheel size	Ø100 × 50.8mm
馬達冷卻泵浦 Coolant pump motor	1/8HP
機械尺寸 Machine size	1150 × 750 × 1350mm
裝箱尺寸 Packing size	1240 × 880 × 1640mm
淨重/毛重 N.W. / G.W.	330 / 420kgs

仿型磨刀機(1:1)

GM-330 Profile Grinder

磨刀能力錫鋼四面鉋刀Grinding capacity Cutters	Ø10" × 10"
H.S.S刀頭(刀柄外徑)H.S.S. cutter head	Ø10" × 10"
工作台最大行程 左右移動Work table(left-right)	265mm
工作台最大行程 前後移動Work table(back-front)	110mm
砂輪規格Grinding wheel size	Ø200 × Ø60mm
砂輪迴轉數Speed of grinding wheel	1500-4200R.P.M. variable speed
馬達砂輪Motor Grinding wheel	2.2kw
馬達冷卻泵浦Cooling system	1/8 HP
電氣自動控制 Electric system	電磁式保護開關 Magnetic switch
機械尺寸Machine size	1040 × 1120 × 1500mm
裝箱尺寸Packing size	1220 × 1220 × 1600mm
機械重量Net weight	800kgs
裝箱重量Gross weight	950kgs



仿型磨刀機(1:1)

GM-312 Profile Grinder

磨刀能力錫鋼四面鉋刀Grinding capacity Cutters	Ø12" × 12"
工作台最大行程 左右移動Work table(left-right)	320mm
工作台最大行程 前後移動Work table(Back-front)	125mm
砂輪規格Grinding wheel	Ø255 × 6 × Ø31.75mm
砂輪迴轉數Speed of grinding wheel	1720-2940R.P.M.
馬達砂輪Motor Grinding wheel	2HP
馬達冷卻泵浦Cooling system	1/8HP
電氣自動控制 Electric system	電磁式保護開關 Magnetic switch
機械尺寸Machine size	1050 × 1220 × 1380mm
裝箱尺寸Packing size	1330 × 1330 × 1570mm
機械重量Net weight	940kgs
裝箱重量Gross weight	1100kgs



仿型磨刀機(1:1)

GM-250A Profile Grinder

砂輪規格 Grinding wheel size	Ø150 × 16mm
砂輪迴轉速 Grinding wheel speed	3400R.P.M.
砂輪馬達 Grinding wheel motor	1HP
馬達冷卻泵浦 Coolant pump motor	1/8HP
機械尺寸 Machine size	800 × 850 × 1380mm
裝箱尺寸 Packing size	1000 × 1000 × 1480mm
淨重/毛重 N.W. / G.W.	340 / 420kgs

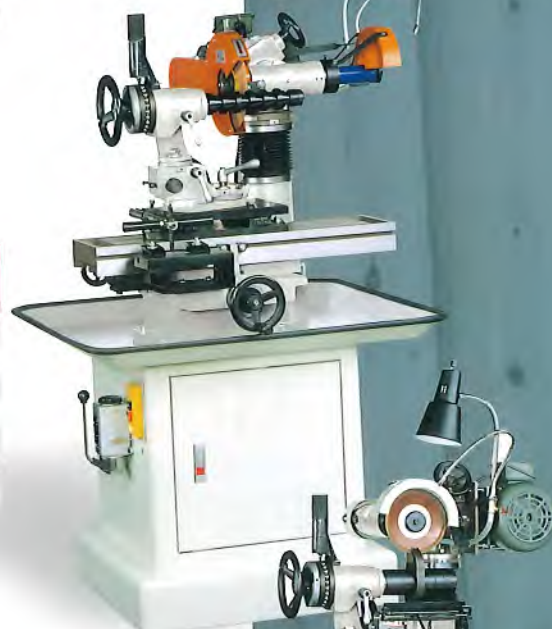

指接榫刀磨刀機

GM-270 Grinder for Finger Jointer Cutter

砂輪迴轉速 Grinding wheel speed	3400R.P.M.
砂輪馬達 Grinding wheel motor	1HP
馬達冷卻泵浦 Coolant pump motor	1/8HP
Table longitudinal travel	Crossed roller linear motion guide
Table cross travel	Crossed roller linear motion guide
Indexing device	Conventional micro adjustment
機械尺寸 Machine size	800 × 850 × 1380mm
裝箱尺寸 Packing size	1000 × 1000 × 1480mm
淨重/毛重 N.W. / G.W.	310 / 390kgs



DUST COLLECTOR 集塵機

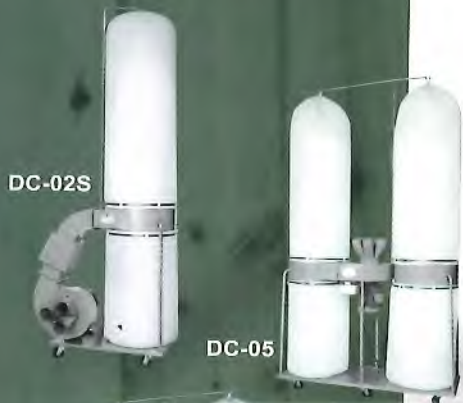

DC-02S

DC-05

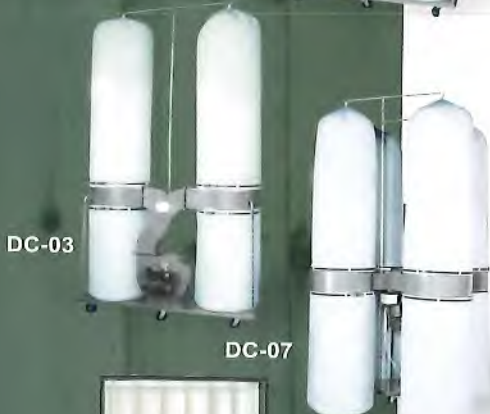

DC-03

DC-07

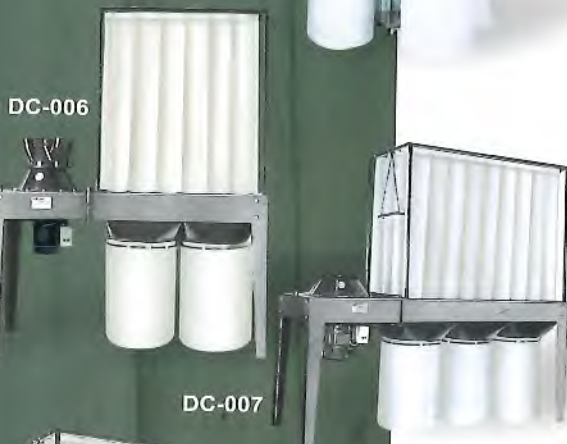

DC-006

DC-007



DC-008

DC-065



DC-068

集塵機

DC-02S Dust Collector

使用馬力 Motor	2HP/3HP
吸風口 Air suction	4"×3 holes, 4"×4 holes
風速 Air speed	23M/sec-27M/sec
風量 Air delivery	45m ³ /min, 50m ³ /min
音量 Sound rating	85dB
淨重/毛重 N.W. / G.W.	84 / 91kgs

集塵機

DC-05 Dust Collector

使用馬力 Motor	3HP/5HP
吸風口 Air suction	4"×4 holes, 4"×6 holes
風速 Air speed	23M/sec-27M/sec
風量 Air delivery	50m ³ /min, 60m ³ /min
音量 Sound rating	85dB
淨重/毛重 N.W. / G.W.	95 / 103kgs

集塵機

DC-03 Dust Collector

使用馬力 Motor	3HP/5HP
吸風口 Air suction	4"×4 holes, 4"×6 holes
風速 Air speed	23M/sec-27M/sec
風量 Air delivery	50m ³ /min, 60m ³ /min
音量 Sound rating	85dB
淨重/毛重 N.W. / G.W.	94 / 102kgs

集塵機

DC-07 Dust Collector

使用馬力 Motor	7-1/2HP / 10HP
吸風口 Air suction	4"×8 holes, 4"×10 holes
風速 Air speed	23M/sec-27M/sec
風量 Air delivery	75m ³ /min, 80m ³ /min
音量 Sound rating	85dB
淨重/毛重 N.W. / G.W.	165 / 200kgs

集塵機

DC-006 Dust Collector

使用馬力 Motor	5HP
風速 Air speed	43M/sec
風量 Air delivery	182m ³ /min
C.F.M.	6440
吸風口 Air suction	125mm×5holes
集塵袋 Collection bag	Ø61cm×2pcs
所佔空間 Space occupied	243×98×308cm
包裝尺寸 Packing size	150×110×110cm
淨重/毛重 N.W./ G.W.	200 / 380kgs

集塵機

DC-007 Dust Collector

使用馬力 Motor	7.5HP
風速 Air Speed	47M/sec
風量 Air delivery	241m ³ /min
C.F.M.	8518
吸風口 Air suction	125mm×6holes
集塵袋 Collection bag	Ø61cm×3pcs
所佔空間 Space occupied	292×98×308cm
包裝尺寸 Packing size	215×110×110cm
淨重/毛重 N.W./ G.W.	250 / 300kgs

集塵機

DC-008 Dust Collector

使用馬力 Motor	10HP
風速 Air speed	52M/sec
風量 Air delivery	354m ³ /min
C.F.M.	12496
吸風口 Air suction	125mm×8holes
集塵袋 Collection bag	Ø61cm×4pcs
所佔空間 Space occupied	387×98×308cm
包裝尺寸 Packing size	250×110×85cm
淨重/毛重 N.W./ G.W.	300 / 380kgs

集塵機

DC-065 Dust Collector

風車馬力 Blower motor	1-1/2HP×2set
風量 Air delivery	40m ³ /min
過濾面積 Filter area	13m ²
所佔空間 Space occupied	176×102×81cm
包裝尺寸 Packing size	203×120×100cm
淨重/毛重 N.W./ G.W.	170 / 200kgs

集塵機

DC-068 Dust Collector

風車馬力 Blower motor	1-1/2HP×3set
風量 Air delivery	58m ³ /min
過濾面積 Filter area	20m ²
所佔空間 Space occupied	253×102×81cm
包裝尺寸 Packing size	282×120×100cm
淨重/毛重 N.W./ G.W.	210 / 250kgs

流程規劃 → 製造 → 安裝 → 售後服務
 Process design → Manufacturing → Installation → Service



裝車式集塵儲料設備

Dust Collecting storing Equipment of Loading Mode



並聯式袋濾集塵設備

Bag-Filter Dust Collecting Equipment of integrate mode



水洗塗裝噴漆台設備

Painting water booth Equipmnet



工業用離心式抽送風機

Air Blower (PLATE FAN, TURBO, AIRFOIL) of Industrial Centrifugal Mode

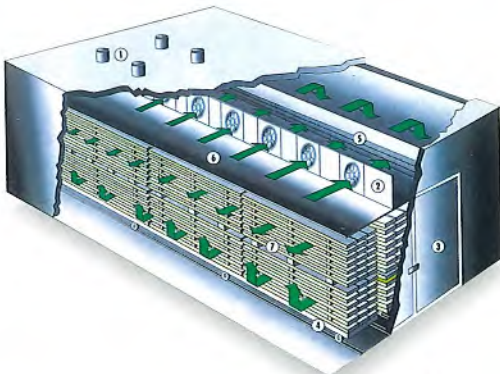

蒸汽式烘房

STEAM OVEN

- ① venting units 通風孔
- ② fan baffle with auxiliary fans 風扇擋板及輔助風扇
- ③ kiln door(2-wing)雙扇窯門

- ④ rail carts 軌道材車
- ⑤ radiator 散熱器
- ⑥ false ceiling 風扇地板
- ⑦ wood stack 材堆

Not illustrated: spraying device, wood moisture measuring points, air temperature and humidity measuring systems, control unit, 未圖說部份: 灑水裝置、木材濕度測定器、空氣溫濕度測定系統、控制組。



電子除濕乾燥機

Electronic Dehumidification Dryer



▲乾燥窯內部安裝情形
 Dry Kiln Inside Installations

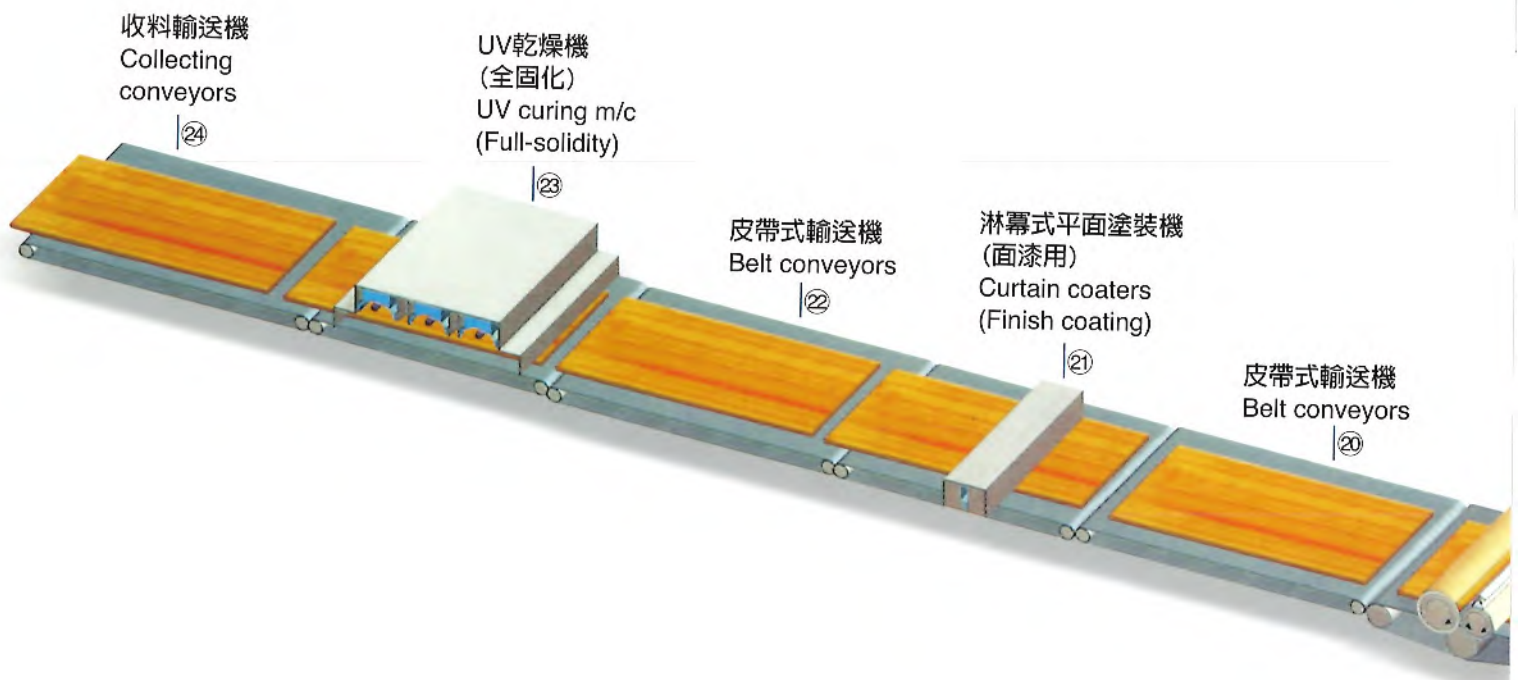
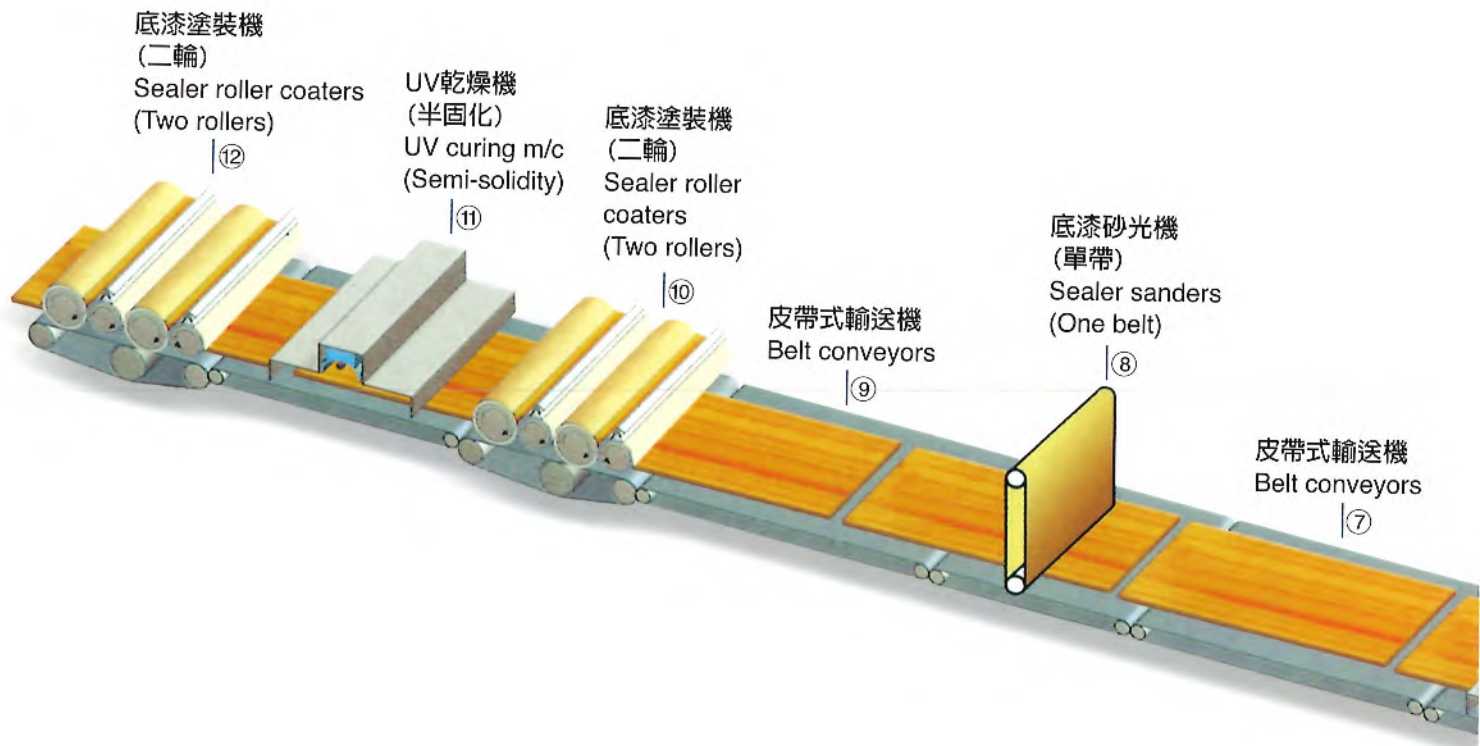

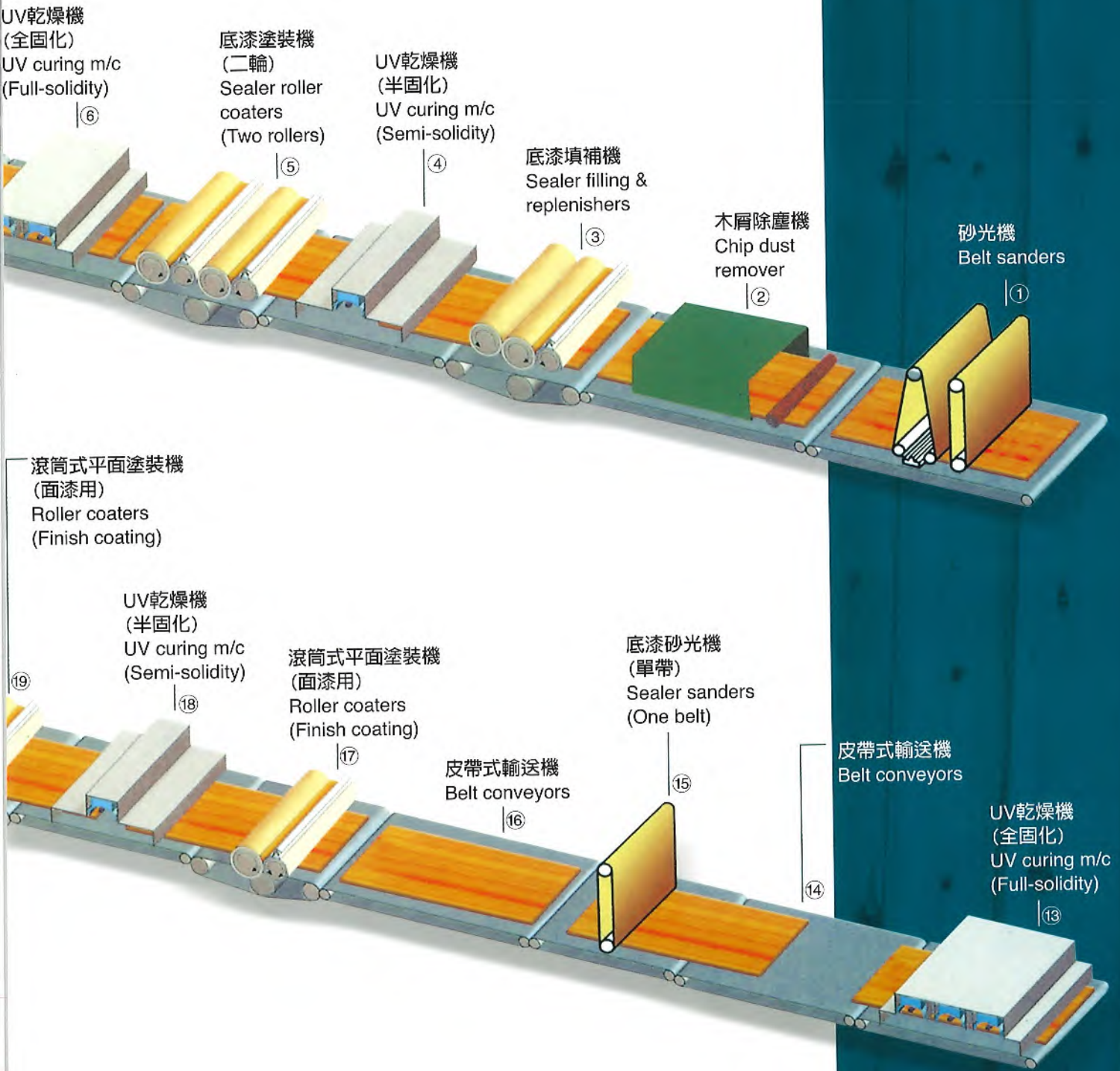



曲木成型機 Curved Wood Forming Presses

	PF-33-100	PF-34-100	PF-35-100	PF-36-130	PF-35-3
工作台尺寸 Platen size	910×910mm	1220×910mm	1520×910mm	1830×910mm	1520×1000mm
最大開距 Daylight	1400mm	1400mm	1400mm	1400mm	1580mm
總出力 Total thrust	100Ton	100Ton	100Ton	130Ton	100Ton(主Main) 70Ton(側Side)
油壓缸 Hyd. cyl.	Ø250×1	Ø250×1	Ø250×1	Ø200×2	Ø250×1(主Main) Ø150×2(側Side)
行程 Stroke	900mm	900mm	900mm	900mm	900mm(主Main) 240mm(側Side)
油壓動力 Hyd. power	7-1/2HP	7-1/2HP	7-1/2HP	7-1/2HP	7-1/2HP

專用型冷壓機 Special Cold Presses

	PF-15	PF-30	PF-60	PF-100	PF-150	PF-100A
工作台尺寸 Platen size (A×B)	2500×1250mm	2500×1250mm	2500×1250mm	2500×1250mm	2500×1250mm	2500×1250mm
最大開距 Daylight (D)	1000mm	1000mm	1000mm	1000mm	1000mm	1000mm
總出力 Total thrust	15Ton	30Ton	50Ton	100Ton	130Ton	100Ton
油壓缸 Hyd. cyl.	Ø80×4	Ø80×4	Ø100×4	Ø125×4	Ø150×4	Ø125×4
行程 Stroke (cs)	500mm	500mm	500mm	500mm	500mm	500mm
壓力 Pressure kg/cm ² (psi)	0.48(6.8)	0.96(13.6)	1.9(26.9)	3.2(45.4)	4.8(68.2)	3.2(45.4)
油壓動力 Hyd. power	3HP	5HP	5HP	5HP	7-1/2HP	5HP
機械尺寸 Machine size(L×W×H)	3100×1400×2400mm	3300×1400×2400mm	3300×1400×2400mm	3300×1400×2400mm	3400×1400×2500mm	2800×1500×3400mm

曲木分條機 Curved Wood

	PF-151	PF-151A
工作台尺寸 Platen size	1550×1220mm	1550×1220mm
工作台高度 Table height	760mm	760mm
立軸高度 Spindle height	230mm	230mm
送料速度 Feeding speed	5m/min	3-10m/min
主軸動力 Spindle power	7-1/2HP	15HP
送料動力 Feeding power	1/2HP	1/2HP

油壓昇降平台 HYD. Elevating Platform

	PF-36	PF-48
工作台尺寸 Platen size	1000×2000mm	1200×2400mm
最低 Min.	350mm	350mm
最高 Max.	1650mm	1850mm
行程 Stroke	1300mm	1500mm
承載重量 Loading	3000kg	3000kg
油壓動力 Hyd. power	2HP	2HP
上升時間 Lifting time	48/58 sec.	38/46 sec.
油壓缸 Hyd. cyl.	Ø100-270×2	Ø100-310×2



A210 外牙特殊鑽頭 THREADED SHANK SOLID DRILLS

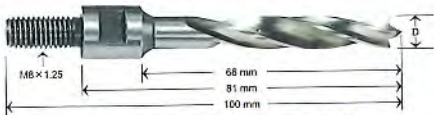

High Speed Steel Spiral Flute L. H. or R. H. Cut

RS210 組合式外牙特殊鑽頭 (新式經濟型) THREADED SHANK SOLID DRILLS WITH INTEGRAL ADAPTER (NEWLY ECONOMIC TYPE)

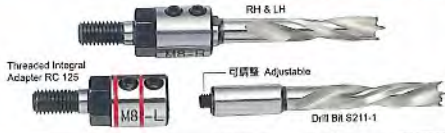

K112-2T 桿槽刀 STRAIGHT SHANK SOLID MORTISING TOOL

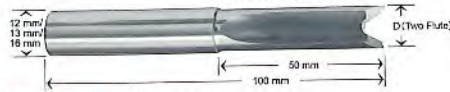

K112-4T 桿槽刀

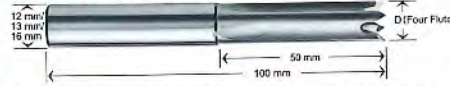

High Speed Steel Straight Flute Two Flute / Four Flute

S211-4T 直柄鑽頭 STRAIGHT SHANK SOLID DRILLS

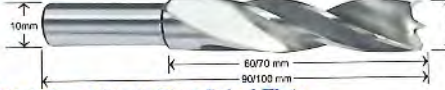

High Speed Steel Four Spiral Flute

S211-2T 直柄鑽頭 STRAIGHT SHANK SOLID DRILLS

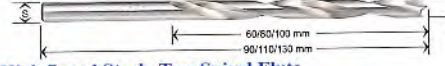

High Speed Steel Two Spiral Flute

TCT510-1 鎢鋼鑽頭 TUNGSTEN CARBIDE STEEL TIPPED DRILLS Spiral Flute L. H. or R. H. Cut (SPECIAL TCT) (特別材質)



TCT510-V 鎢鋼鑽頭 (鑽穿式) TUNGSTEN CARBIDE STEEL TIPPED DRILLS

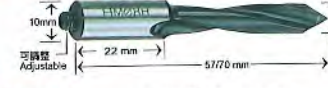

Spiral Flute L. H. or R. H. Cut
Shank Dia.: 10mm
Overall Length: 57/70 mm
Flute Length: 35/48 mm
Drill Dia.: 5.0/6.0/8.0/9.0/10.0/12.0 mm

TCT510 鎢鋼鑽頭 (鑽孔)

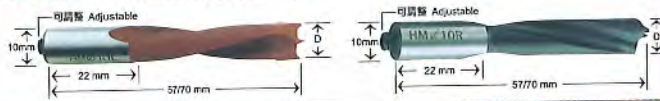

H211-L 組合沙拉刀套 H211-V INTEGRAL SALAD ADAPTER



High Speed Steel Spiral Flute

AH211-L 組合外牙沙拉刀套 AH211-V THREADED INTEGRAL SALAD ADAPTER



High Speed Steel Spiral Flute L. H. or R. H. Cut

A210-L 外牙特殊雙層鑽頭 A210-V THREADED SHANK SOLID STEP DRILLS



High Speed Steel Spiral Flute L. H. or R. H. Cut

S211-BL 直柄雙層鑽頭 S211-BV STRAIGHT SHANK SOLID STEP DRILLS



High Speed Steel Spiral Flute



ACCESSORIES 配件



※捨棄式“螺旋平刀”特別推薦，本產品具有高強度、低噪音、重切削及輕馬力之優點。
 ※SPECIAL RECOMMEND DISPOSABLE “SPIRAL PLANERHEAD” FOR HIGH STRENGTH, LOW NOISE, HEAVY DUTY CUTTING & LOW HORSEPOWER.

油壓刀頭優點在於消除新與舊軸心和刀具組合背隙、動平衡、切削面波浪等問題
 The hydraulics cutterhead is designed to solve the gap problem between the cutterhead in the new and old spindle, dynamic balance and solve wave marking on the cutting surface.



**SPECIALIZED (MFG.) IN ALL KINDS OF
SANDING SPONGE AND PU ROLLER FOR
WOODWORKING SINCE 1950.**

**各種砂光、研磨、木工機械用海綿
橡膠輪、刻溝輪、展開輪**

- 1,2,7.-11
PU 海綿輪 PU SPONGE POLLER
- 3-5,28,37,38,74
橡膠刻溝輪 RUBBER OBLIQUE ROLLER
- 6,64,65
橡膠輪 RUBBER ROLLER
- 12-26,29,46,49,50,51,62,63
海綿輪 SPONGE ROLLER
- 27
平面砂光機海綿輪
SPONGE ROLLER FOR SANDING MACHINE
- 43-45,47,48
棒式海綿輪 SPONGE ROLLER
- 41,42
氣動工具 AIR TOOL

- 30
木棕輪 ABRASIVE BRUSH WHEEL
- 31,32
紗布絲輪 ABRASIVE FLAP SHEET WHEEL
- 33
鐵棕輪 PALM BRUSH WHEEL
- 34,35
鋁輪 ALUMINUM ROLLER
- 36
空氣輪 AIR ROLLER, AIR DRUM
- 39,40
棕刷 BRUSH
- 46,49,50,51
海綿輪 SPONGE ROLLER
- 52,54,58,72,73,75
送料橡膠輪 POWER FEEDER ROLLER
- 55,56,76,77
四面鋸膠輪 MOULDER ROLLER
- 57,71
橡膠離心輪 RUBBER CENTRIFUGAL WHEEL
- 60
不織布研磨輪 NON-WOVEN WHEEL
- 70,85
海綿砂 SPONGE SANDING BLOCK
- 78
四面鋸鋼輪 STEEL ROLLER
- 79
石墨布 GRAPHITE CLOTH
- 80-84,87,88
4"平面砂布輪 DISC FLAP WHEEL
- 89
砂布套筒 SANDING DRUM
- 61,66-69
棒式膠輪 RUBBER ROLLER



Complete solution for any woodworking production requirement

The best partner for woodworking industry

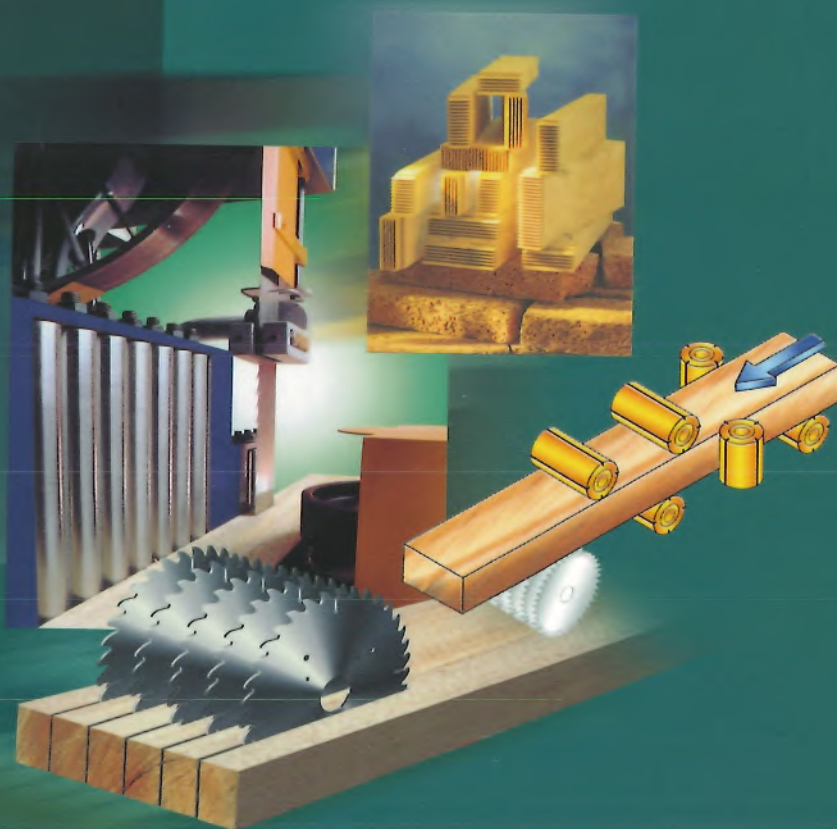

 **SK MACHINERY**

SHUN KUANG MACHINERY FACTORY

NO. 866, SAN FENG RD., FENG YUAN, TAICHUNG, TAIWAN.

TEL:886-4-2522 3475 · 2522 5375

FAX:886-4-2527 3790

E-mail:shunkuan@ms16.hinet.net

<http://www.shunkuang.com.tw>