

Produceert u Zulke of vergelijkbare delen in één bewerkingsgang?

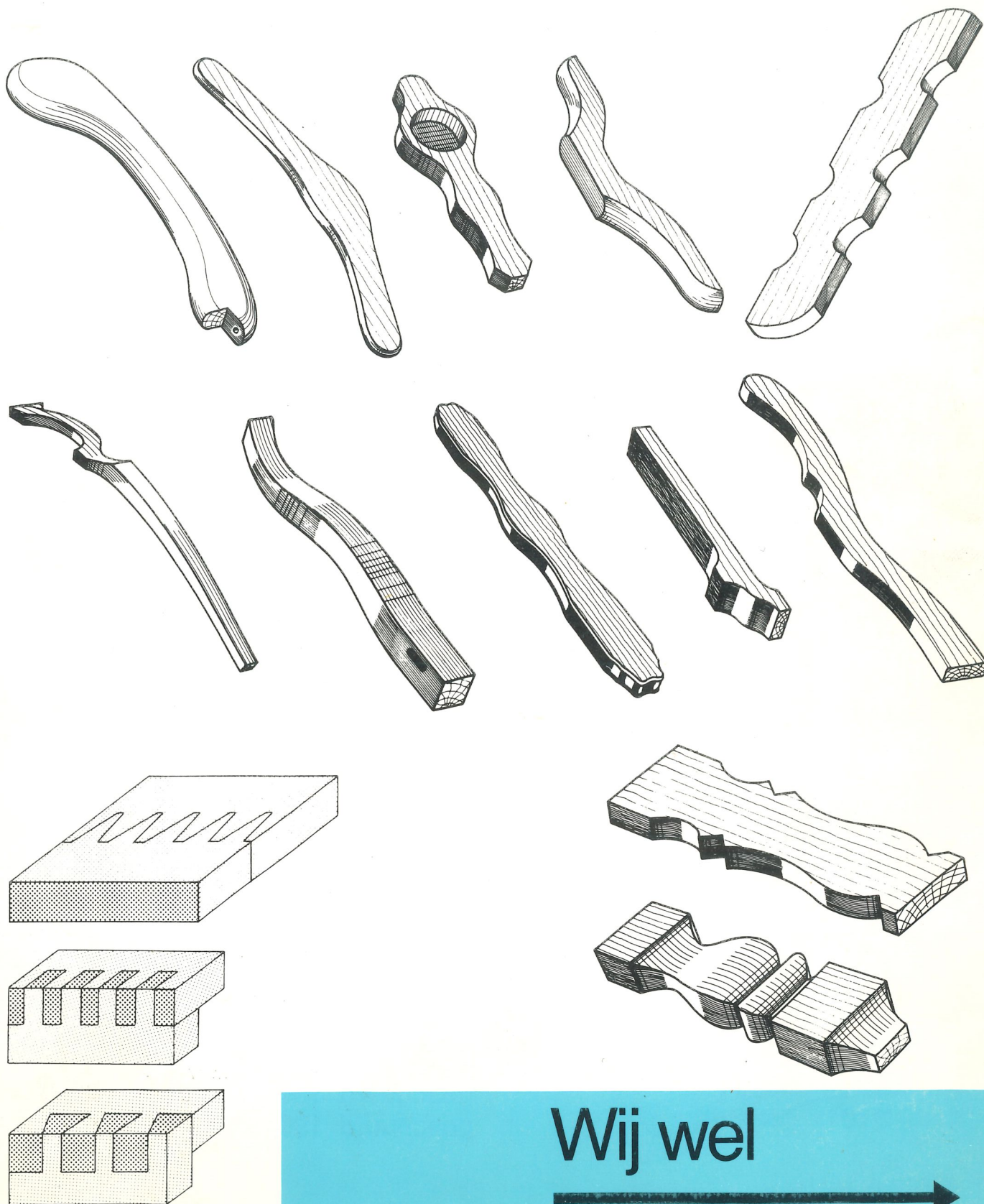

Wij wel



Met deze capaciteit:

Capaciteit/uur

Machinetype

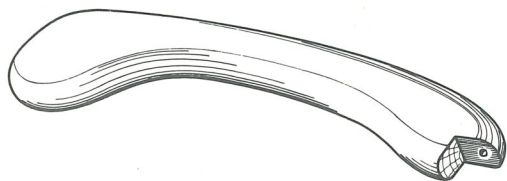

geschuurd 72 stuks 1095
 geschuurd 120 stuks 1092

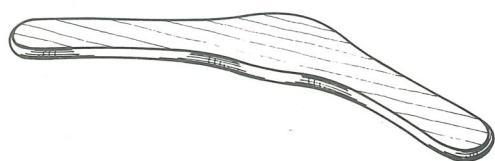

90 stuks 1075 K 4
 140 stuks 1090 L 4
 geschuurd 60 stuks 1095 K 10.1
 geschuurd 100 stuks 1092 L 10.1

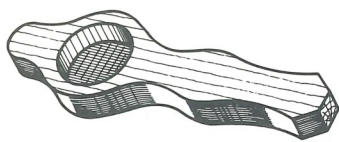

90 stuks 1075 K 4
 140 stuks 1090 L 4
 geschuurd 70 stuks 1095 K 8.1
 geschuurd 110 stuks 1092 L 8.1

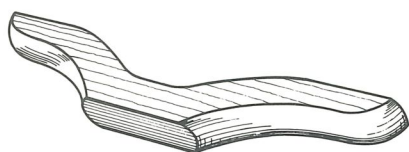

geschuurd 60 stuks 1095 K 6.1
 geschuurd 100 stuks 1092 L 6.1

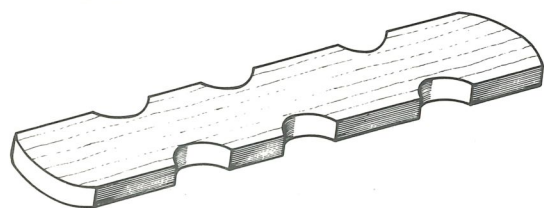

75 stuks 1075 K 4
 110 stuks 1090 L 4



geschuurd 50 stuks 1095 K 8.1
 geschuurd 90 stuks 1092 L 8.1

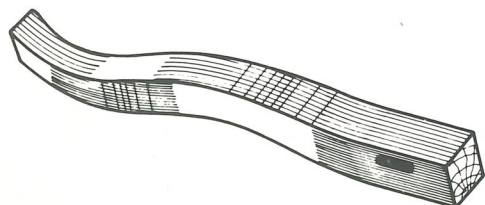

geschuurd 130 stuks 1095 K 8.2
 geschuurd 190 stuks 1092 L 8.2

Capaciteit/uur

Machinetype

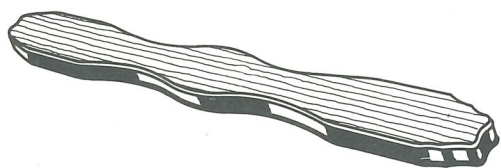

geschuurd 60 stuks 1095 K10.1
 geschuurd 90 stuks 1092 L10.1

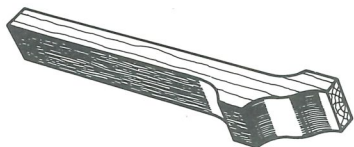

geschuurd 120 stuks 1095 K6.1
 geschuurd 180 stuks 1092 L6.1

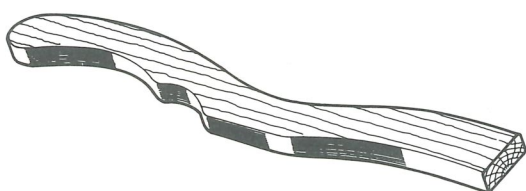

geschuurd 75 stuks 1095 K8.1
 geschuurd 115 stuks 1092 L8.1

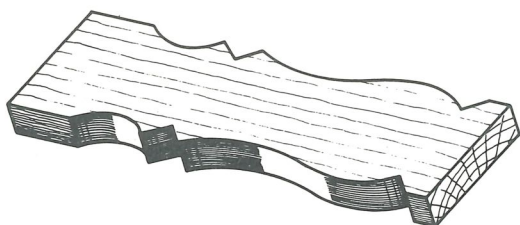

360 stuks 1016

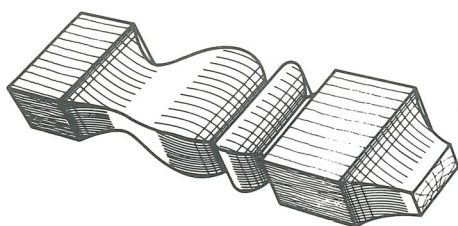

25 stuks 1016

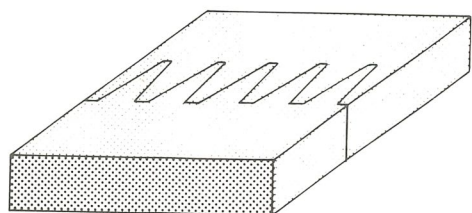

720 stuks 1016

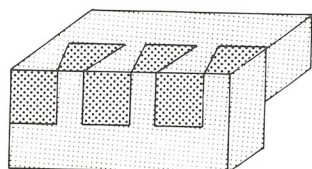

720 stuks 1016

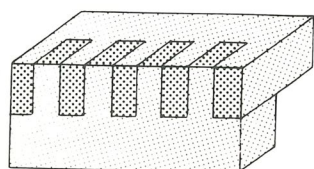

60 stuks 1016

En zo doen wij dat:

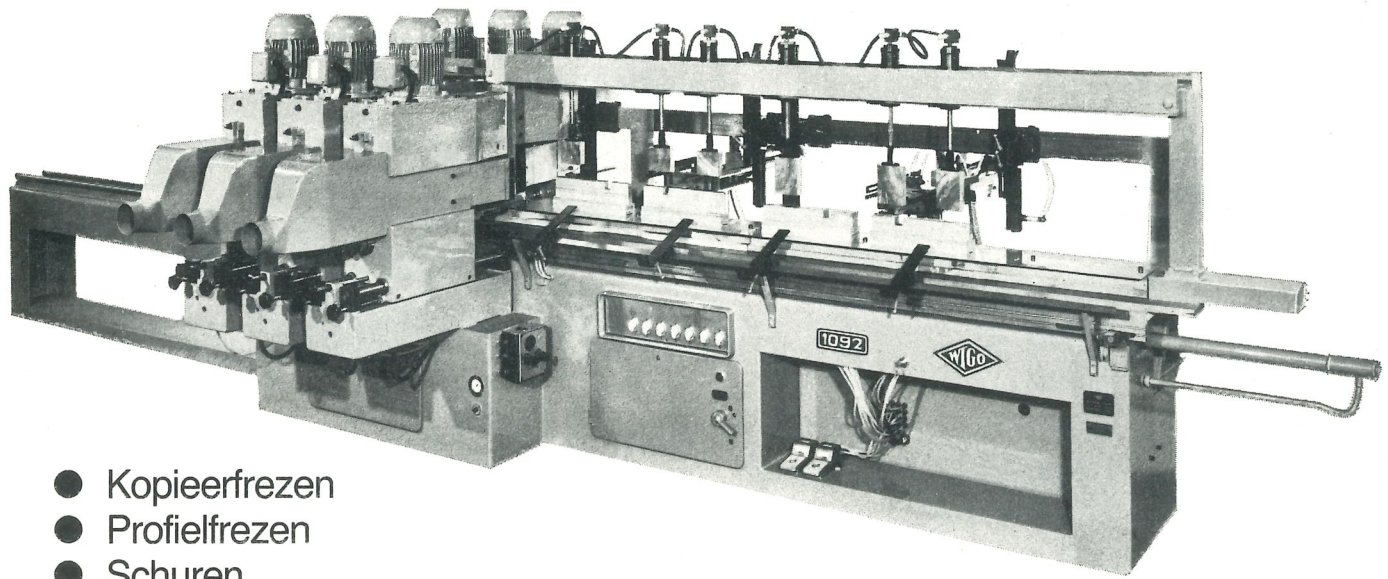

- Kopieerfrezen
- Profielfrezen
- Schuren

Dubbele kopieer-, frees- en schuurmachine 1092/1095

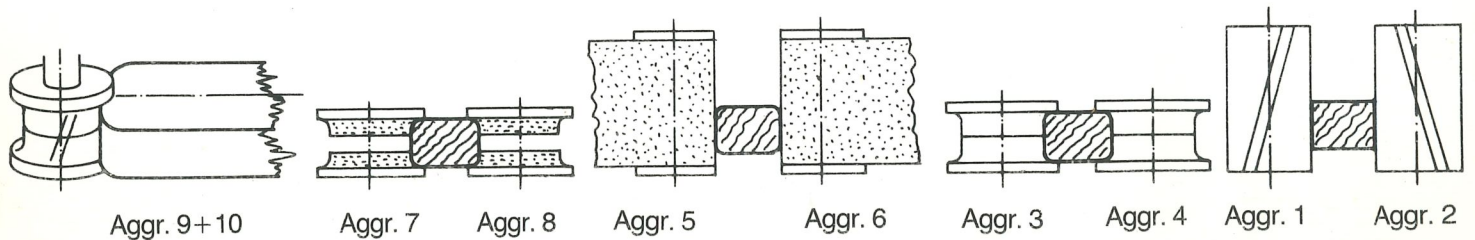
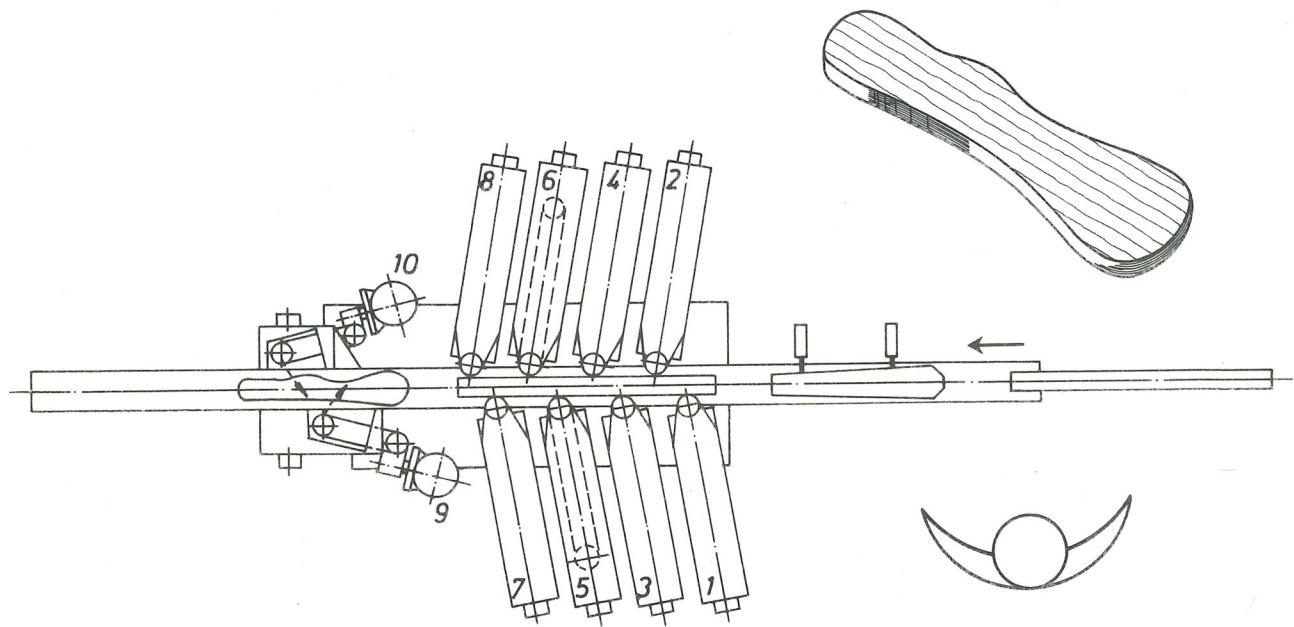

- Kopieerfrezen
- Profielfrezen
- Schuren

- Afkorten
- Boren
- Langgatboren
- en nog diverse andere bewerkingen

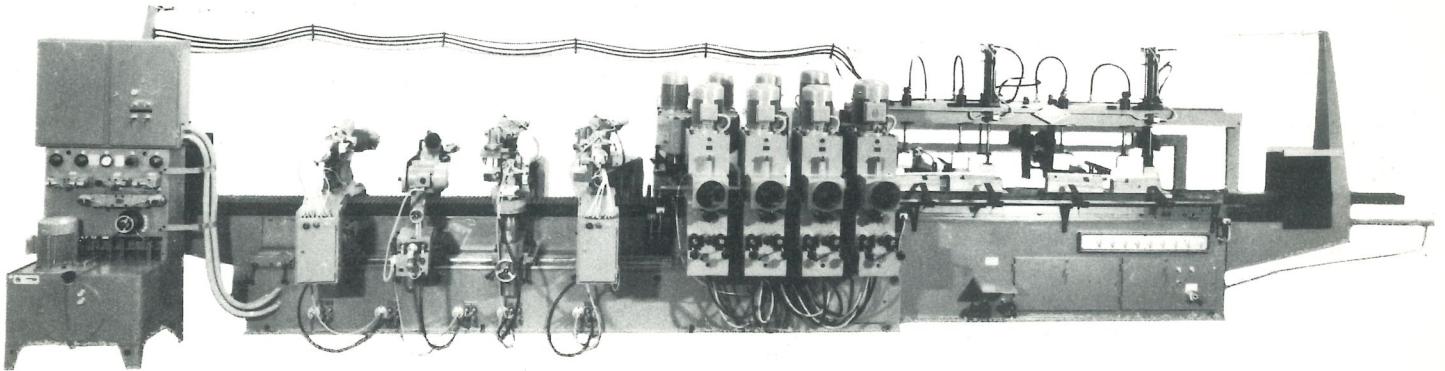

Volautomaat voor gevormde delen WIGOMAT 1091

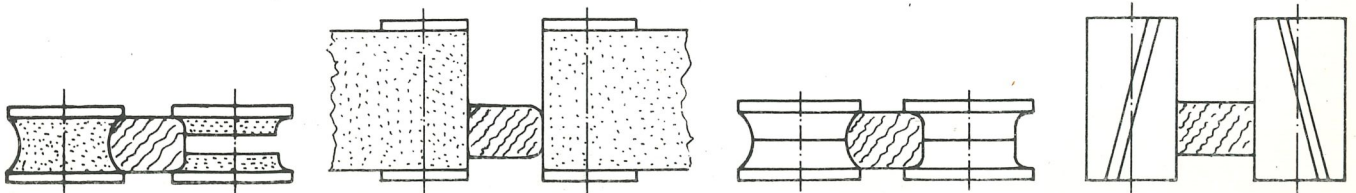
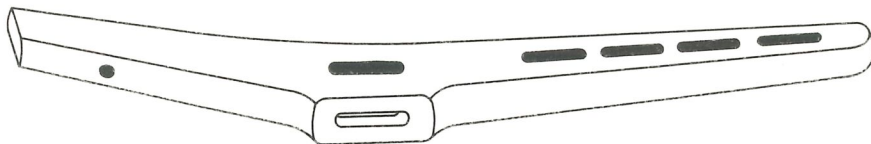
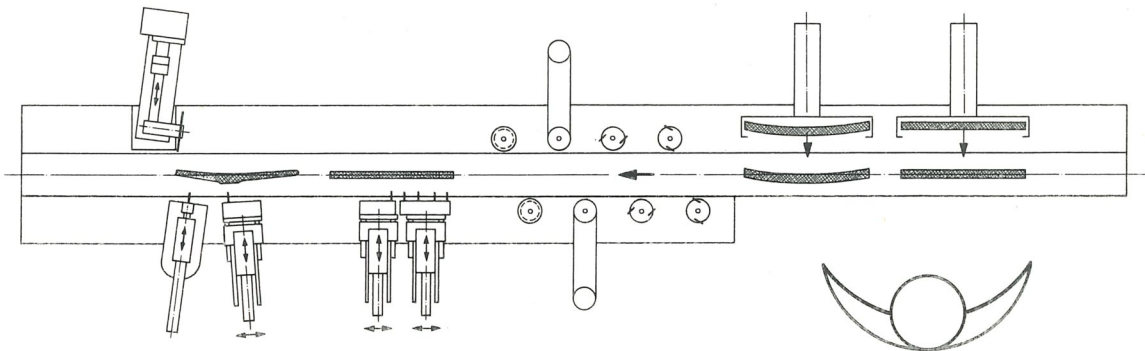

Voor eenvoudiger werk, onze Dubbele kopieer-freesmachine 1075

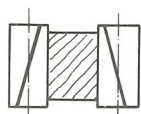
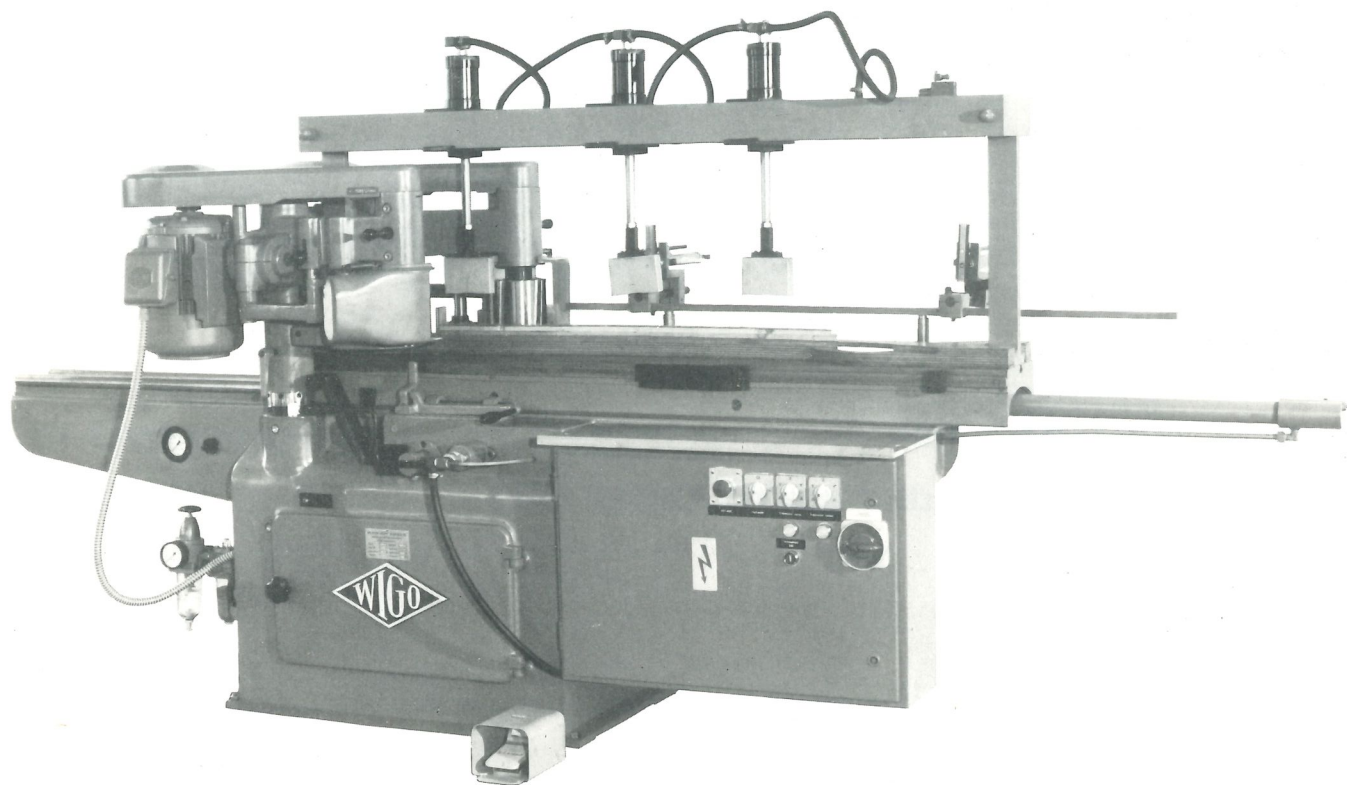

Kopieerfreesen
Profielfreesen

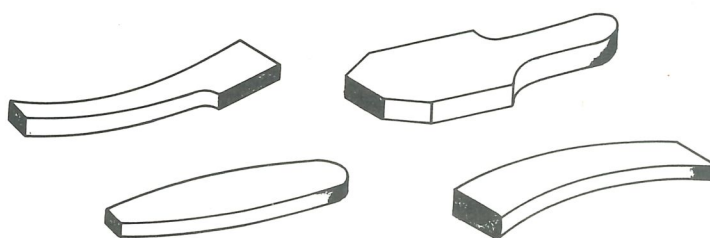

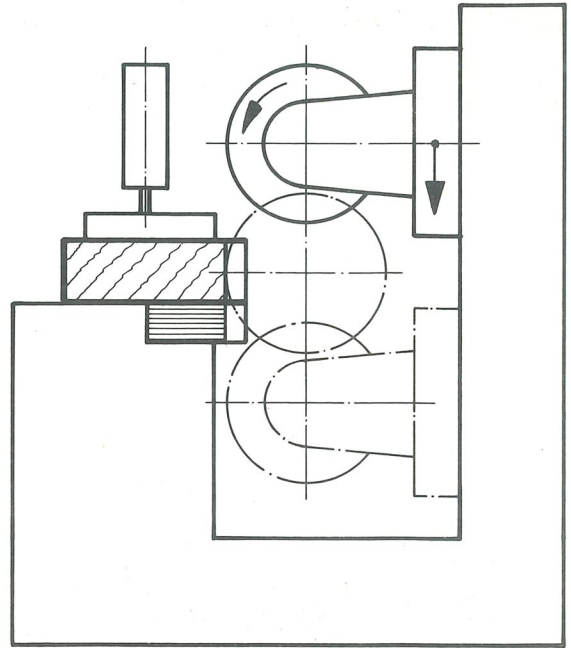
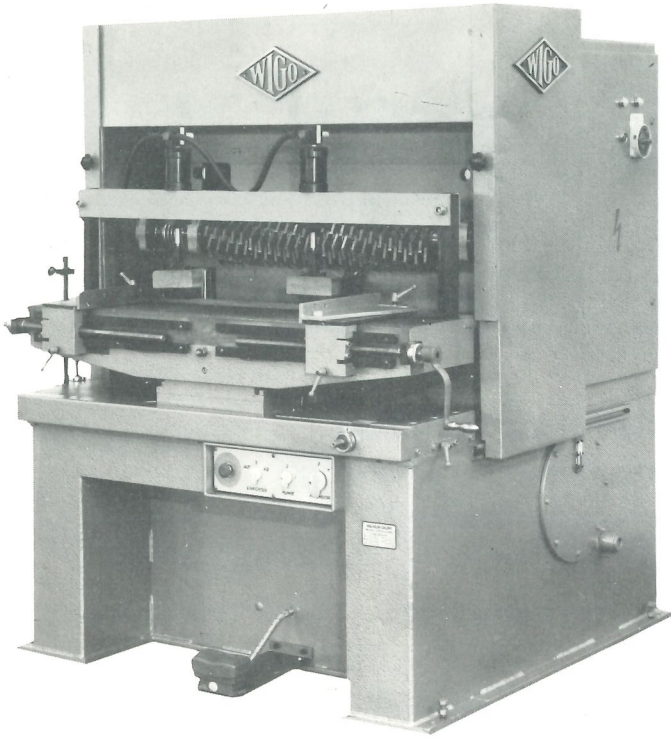

**Vertikale Freesautomat 1016
met hoge capaciteit**

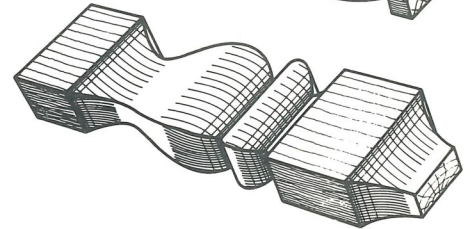
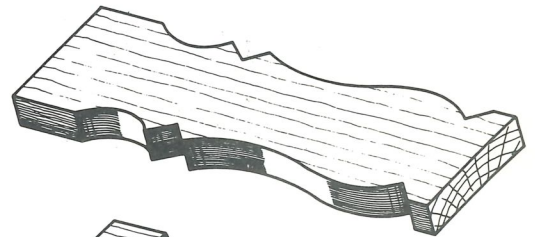
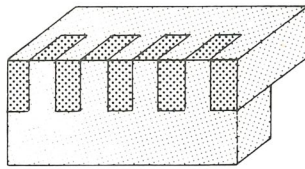
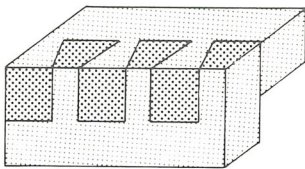

Afzender:

Antwoord

Firma
 Wilhelm Grupp
 GmbH & Co. KG
 Postfach 1149
 D-7082 Oberkochen

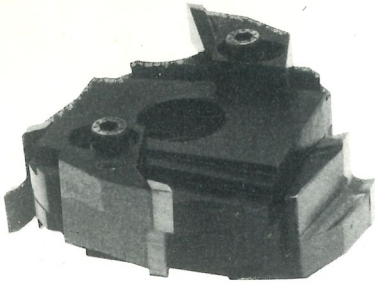

Konstant-profielfrezen

- konstante snijdiameter
- absoluut profielvast
- zeer korte naslijptijden
- alleen verwisseling van de losse messen bij verbruik
- Alleen verwisseling van een beschadigd mes bij schade

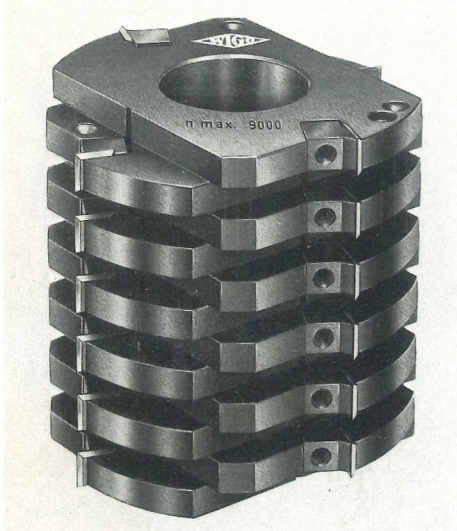

Veeltand-Messenkop

- keermessen-uitvoering (4 × te gebruiken)
- speciaal voor het voorverspanen
- lichte verspaning, daardoor minder motorvermogen noodzakelijk
- betere afzuiging door kortere spanen
- minder inspringsels bij het frezen tegen de draad in
- lager geluidsniveau

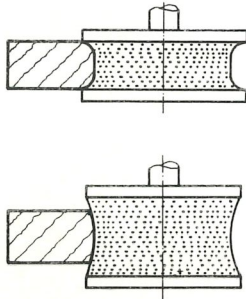

Profielschuurschijven

- voor diverse profielen (kwartrond, halfrond, afgerond, breken...)
- vòorbewerkte schuurbanden
- geschikt voor links- en rechtsloop

Wij verzoeken U om:

- meer informatie
- een gesprek met Uw deskundige
- een demonstratie van de machine
- bijgesloten ontvangt U:
 - tekening of monsters
 - verlangde capaciteit per uur
- wij verzoeken U om een offerte

Plaats, datum _____

volledig adres of firmastempel
