

PRO VER

PLAST
A SMART FT

NC PROCESSING
CENTRE



 **BIESSE**

THE COMPACT MACHINE AT THE SERVICE OF THE INDUSTRY



THE MARKET DEMANDS

a change in manufacturing processes, enabling companies to **accept the largest possible number of orders**. This is coupled with the need to maintain high quality standards whilst offering product customisation **with quick and reliable delivery times**.

BIESSE RESPONDS

with simple, innovative solutions for nesting operations. **ROVER PLAST A SMART FT** is the new high-performance CNC machining centre with super-compact gantry structure, equipped with new bumpers for maximum protection. **ROVER PLAST A SMART FT** is the ideal solution small/medium-sized businesses who require excellent machining quality and ease of use in a small space.



ROVER PLAST A SMART FT

- A SINGLE WORK CENTRE FOR MANY TYPES OF MACHINING OPERATIONS
- EXTREMELY COMPACT AND ERGONOMIC MACHINING
- MAXIMUM FLEXIBILITY
- ACCESSIBLE CUTTING-EDGE TECHNOLOGY
- ERGONOMICS AND SAFETY FOR THE OPERATOR

A SINGLE WORK CENTRE FOR MANY TYPES OF MACHINING OPERATIONS

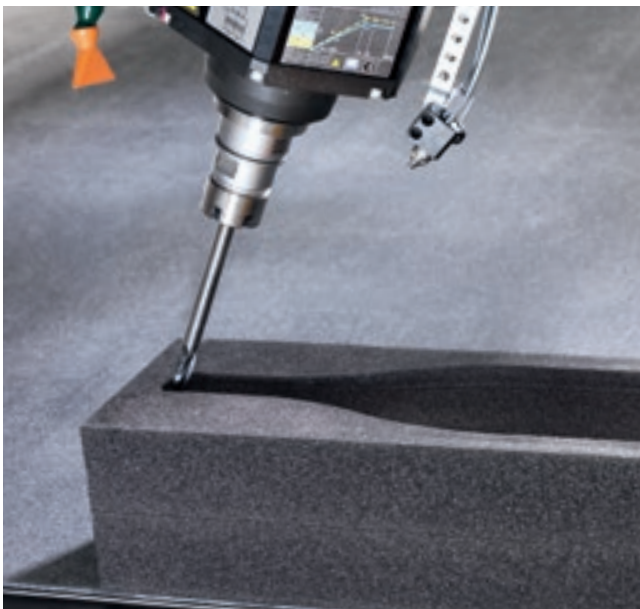

Biesse provides solutions for the processing of materials for the packaging, visual communication, building and industrial sectors, processing expanded and compact plastics, composites and cardboard.

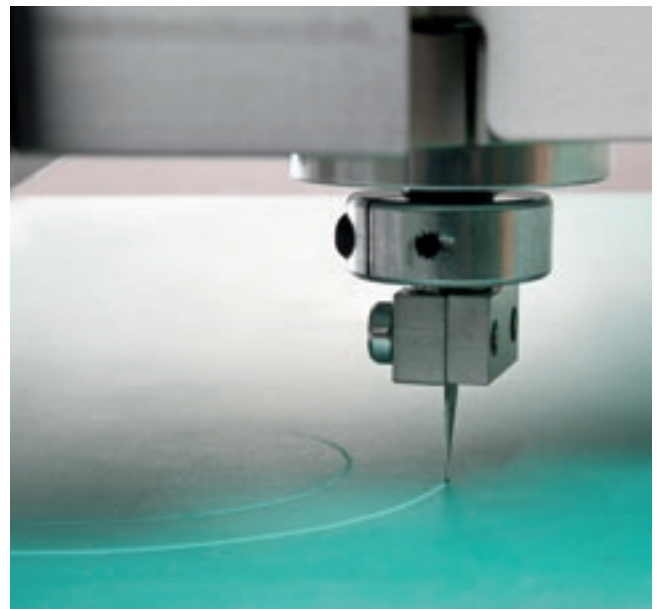
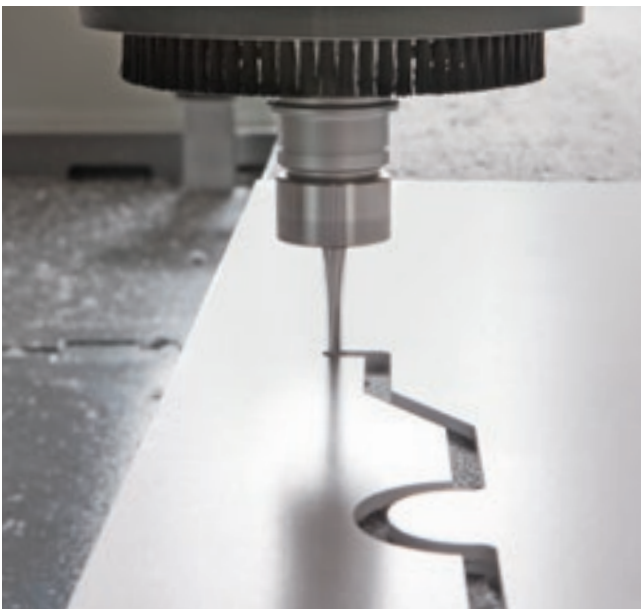
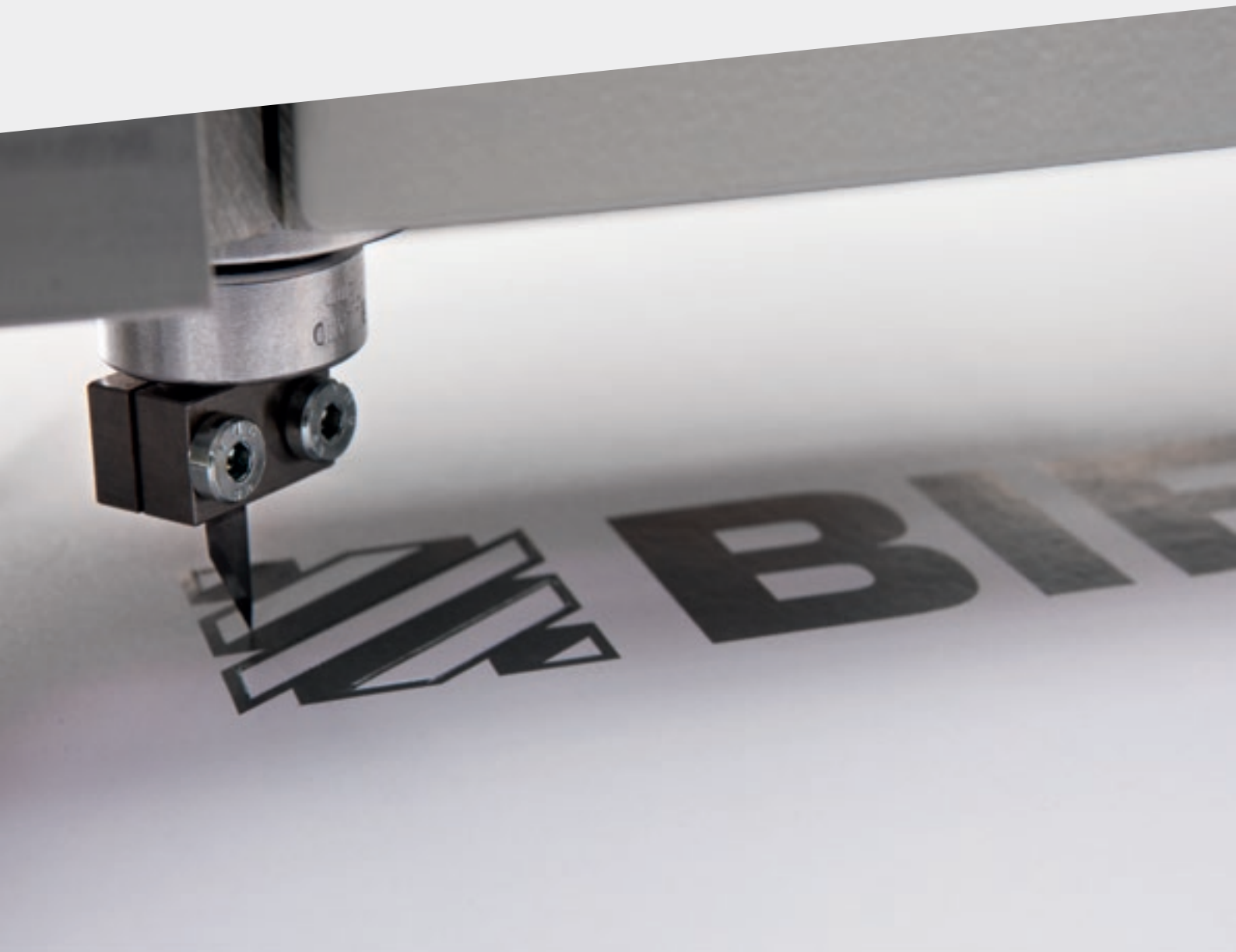

COMPACT AND ERGONOMIC



An extremely compact machining centre designed to adapt to the production space in which it is installed. Enables the operator to safely access all sides of the machine at all times, with no obstacles on the ground.



ONE OF THE MOST COMPACT SOLUTIONS ON THE MARKET.



Enables the operator to constantly check machining quality with ease.



MAXIMUM CUSTOM FLEXIBILITY

There's a wide range of sizes for processing materials of different formats, dimensions and thicknesses, so customers can choose the machine best suited for their own specific requirements

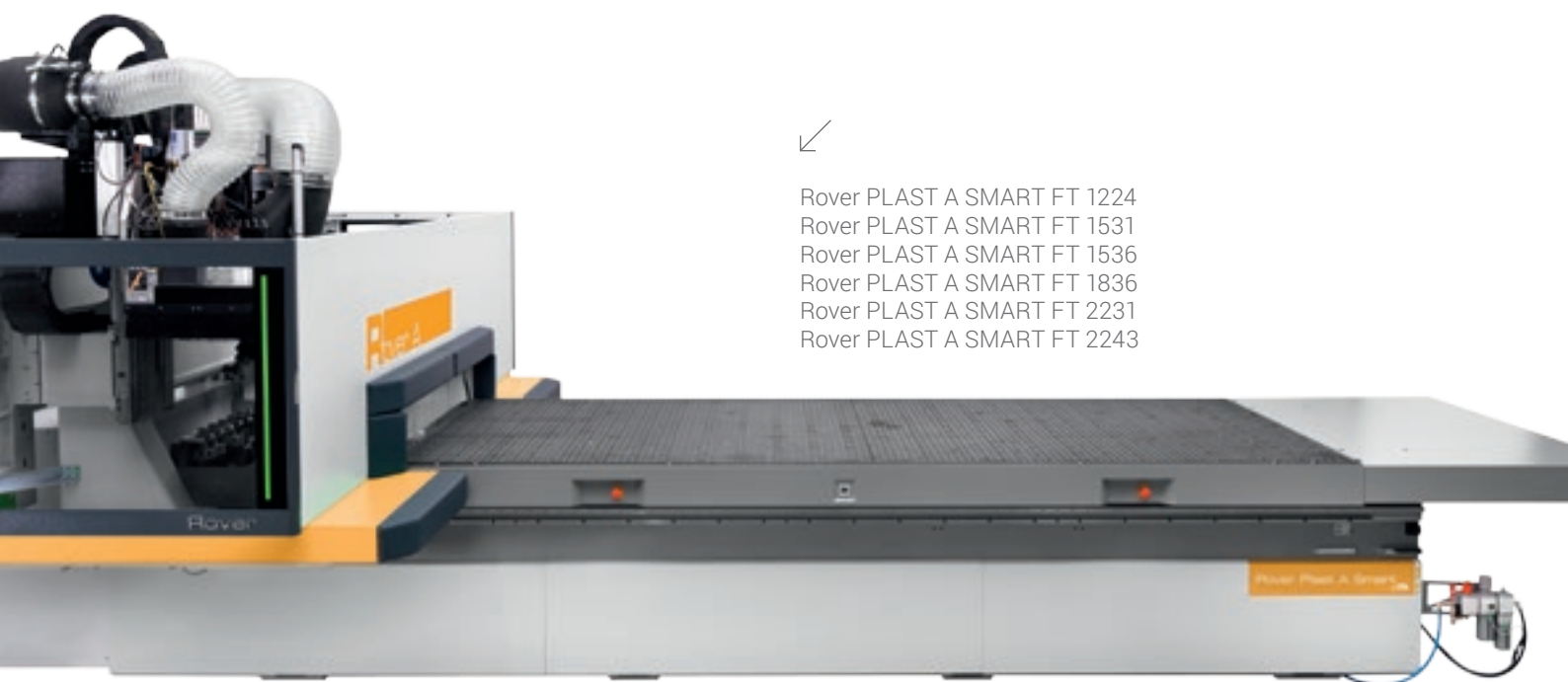

- Rover PLAST A SMART FT 1224
- Rover PLAST A SMART FT 1531
- Rover PLAST A SMART FT 1536
- Rover PLAST A SMART FT 1836
- Rover PLAST A SMART FT 2231
- Rover PLAST A SMART FT 2243

ADVANCED WORK TABLE TECHNOLOGY TO MACHINE PANELS OF DIFFERENT TYPES AND SIZES WITH THE UTMOST RELIABILITY.

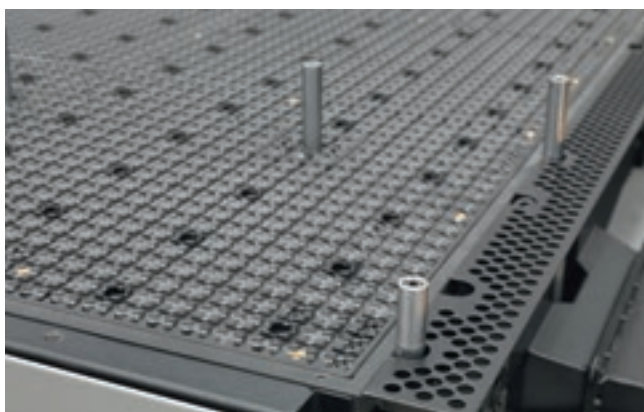

Work table in layered phenolic material with vacuum system.

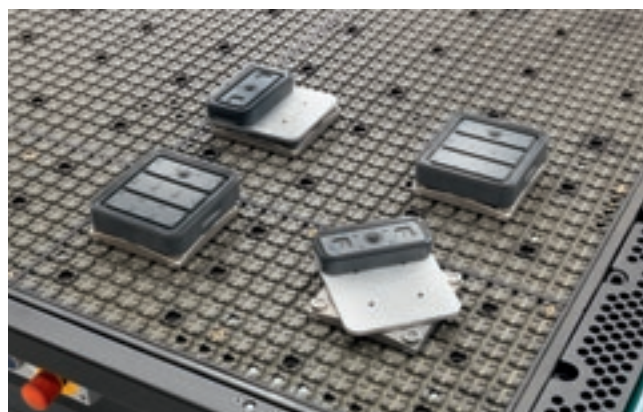

Vacuum modules can be freely positioned on the FT work table with no need for special connections.

MAXIMUM PANEL SECURITY THANKS TO AN ADVANCED DISTRIBUTED VACUUM SYSTEM WITHIN THE WORK TABLE.

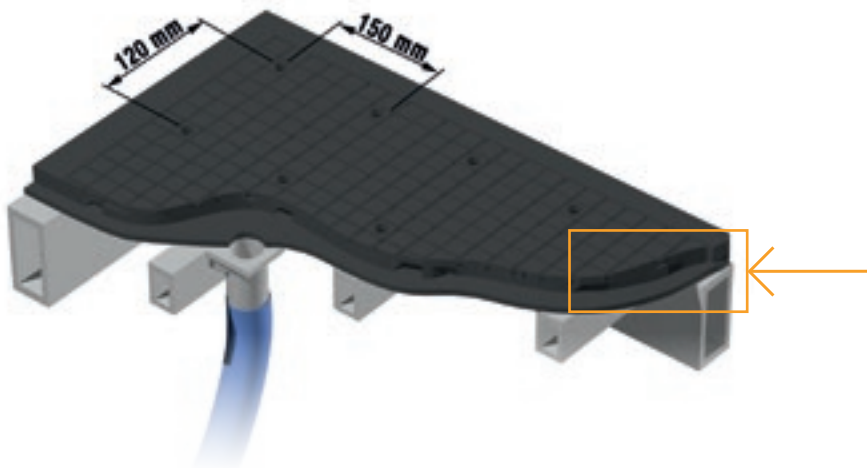

Multi-zone technology seamlessly and automatically adapts the vacuum of the machine to the different board sizes that the customer has in his production.

VACUUM DISTRIBUTION CHAMBER

The high-capacity system ensures an excellent hold on even small pieces, and the machining of breathable materials.



The locking of the vacuum adapts perfectly to the panel size and enables the switching from one format to another without the need for manual operations.



TECH NOLO GY

PERFORMANCE WITHOUT LIMITS

The high technological content of the world's most popular machining centres meets the requirements of operators who process technological materials.

The only solution for performing milling and cutting operations on technological materials. The tangential/oscillating blade, coupled with a camera for reading print markers, supports the full processing of materials for the graphic arts industry. The precision and quality of Rover's technology support the perfect execution of all machining operations typical of a processing centre.

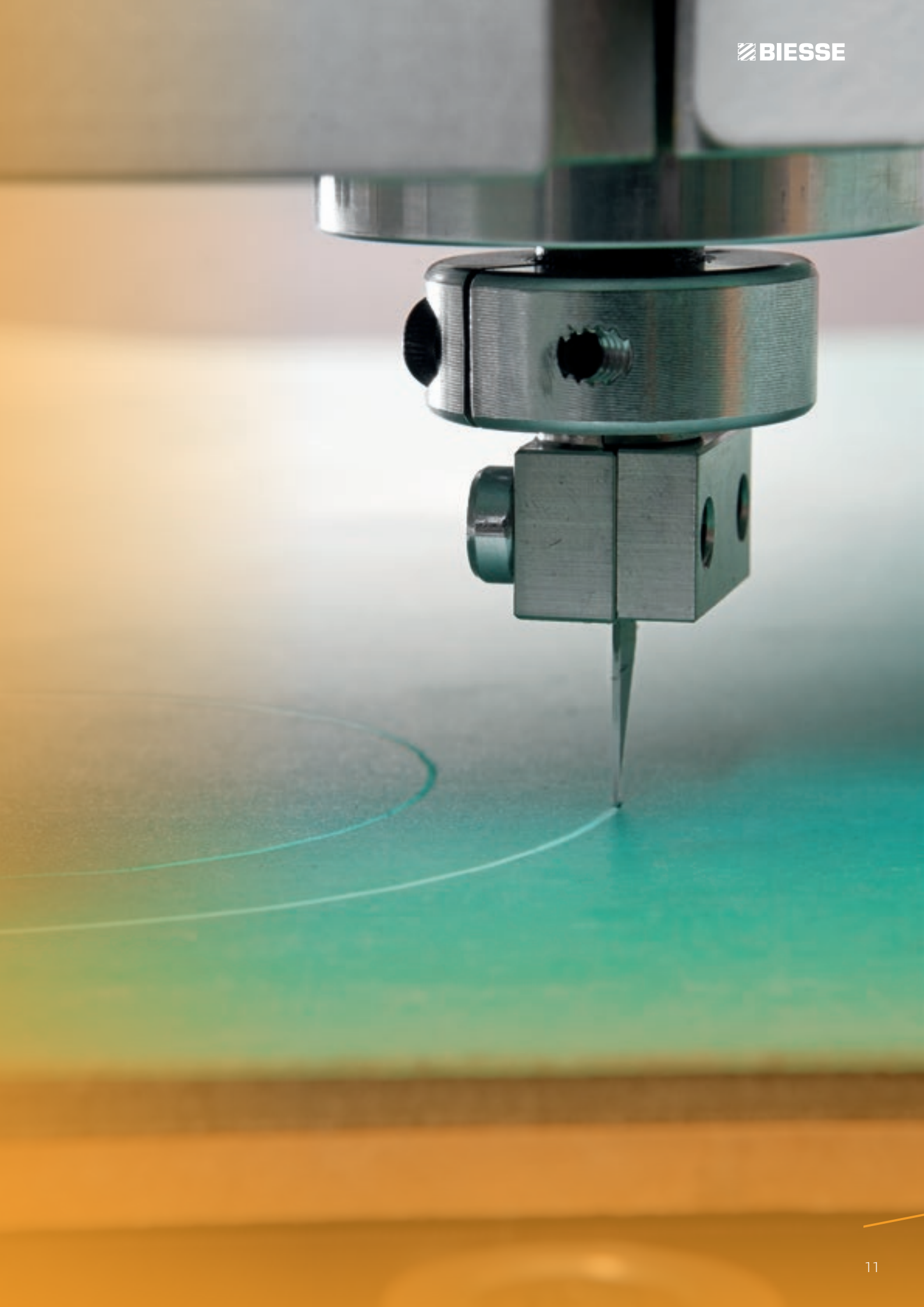

ACCESSIBLE CUTTING-EDGE TECHNOLOGY



The Rover PLAST A SMART FT can be fitted with the same components used on other top-of-the-range models. The electrospindle, is designed and manufactured for Biesse by HSD, the global leader in this sector.

**C AXIS TORQUE:
QUICKER, MORE
PRECISE, MORE RIGID.**

Electrospindles for every application:
- 13 kW HSD with automatic
tool change ISO30 / HSK F63
1,000-24,000 rpm.



LARGE MAGAZINE CAPACITY FOR PERFORMING ALL TYPES OF MACHINING OPERATION

Tool change magazine with up to 24 spaces, rendering all tools and aggregates available at all times with no need for operator intervention when changing tooling between machining operations.



The rack magazine with 13/16 positions provides a simple and functional solution whilst keeping the overall dimensions of the machine as compact as possible.

8-position revolver integrated into the machine beam.

A COMPLETE RANGE OF AGGREGATES



HIGH RELIABILITY AND PRECISION OVER TIME

ROVER PLAST A SMART FT has a robust and well-balanced structure, designed to handle demanding machining requirements without compromising product quality.

The Gantry structure with dual motors is designed to increase precision and reliability standards for the execution of all nesting operations.



Automatic lubrication is an option that ensures the continuous lubrication of the machine's main moving parts without the need for operator intervention.



The air conditioning system for the standard electrical cabinet ensures that all electrical components remain reliable over time.



OPTIMAL CLEANING OF MACHINED COMPONENTS AND WORK AREA



Adjustable suction hood with 12 settings.

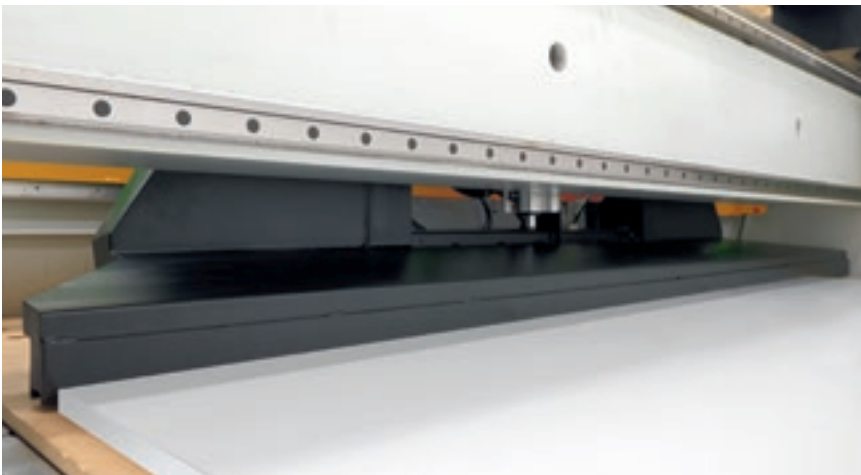

The sweeper arm with integrated suction supports the simultaneous cleaning and unloading of panels, avoiding manual intervention and thus increasing productivity.



Chip removal system positioned between the machine and the unloading belt, guaranteeing optimal panel cleanliness.

Various optional solutions are available for cleaning the panel and the area around the machine, thus saving time for the operator.

5 AXES

USER-FRIENDLY TECHNOLOGY

The high technological content of the world's most popular machining centres meets the requirements of operators who process technological materials.

The 5-axis operating section, equipped with a HSD electrospindle (available in versions from 7.5 to 16 kW) with 360° continuous rotation on the vertical and horizontal axes, enables the machining of complex shapes ensuring quality, precision and absolute long-term reliability.



MAXIMUM ERGONOMICS AND SAFETY FOR THE OPERATOR

Biesse machines are designed to enable operators to work in complete safety.



The new **full bumper** solution enables the operator to safely access the work table at all times from any side of the machine.



Overlapping lateral curtain guards protect the working unit.



Total protection of the working unit. The wide hatch provides maximum visibility of the machining operations, as well as ensuring easy access to the working units.

TECHNOLOGY AT THE SERVICE OF THE USER

New console with Windows real-time operating system and bSolid software interface, including anti-collision system.



MAXIMUM VISIBILITY OF THE WORKING UNIT FROM ANY POSITION

LED bar with 5 colours, indicating the machine status in real time, allowing the operator to check the machine status at any point.



FULLY INTEGRATED INTO PRODUCTION FLOWS

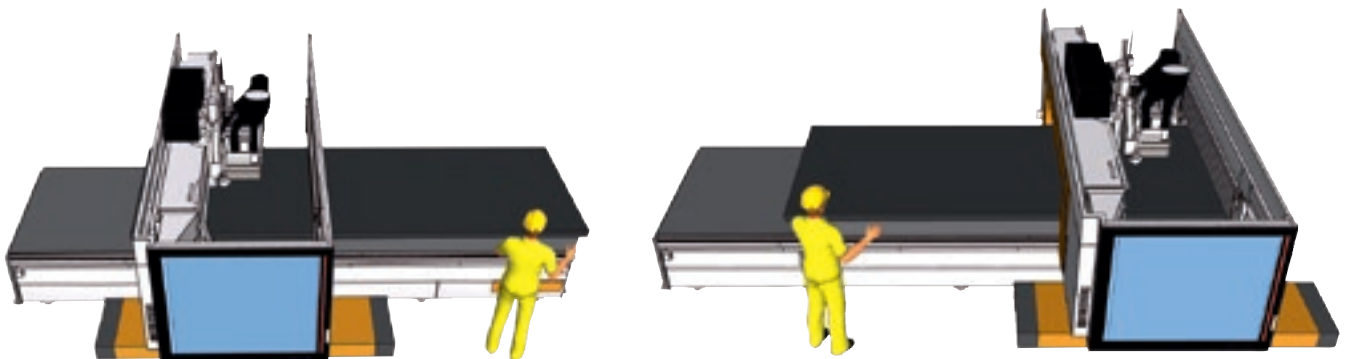

The machine can be configured with tandem loading in order to alternately process panels on opposite origins. This allows loading and unloading to be carried out while the machine is actually running.

Panel identification and traceability with in the production flow thanks to on-demand labelling system.



Machine downtime is dramatically reduced by the unloading belt, which enables the removal of completed panels of various thicknesses outside the machine's working area.

CONFIGURATION



Electrospindle 7,5 kW 36.000 rpm.



Electrospindle 5 axis 13 kW 24.000 rpm.

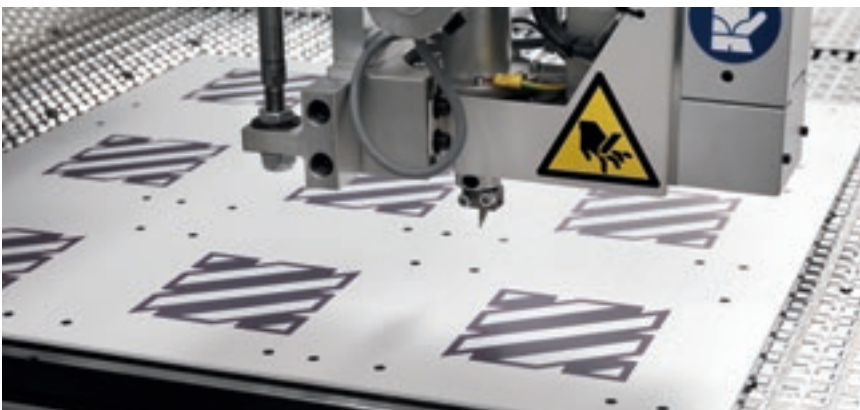

The camera, which allows users to manage print markers, is particularly suited to the graphic arts industry. It can also be used as a support for the cutter and the milling unit.

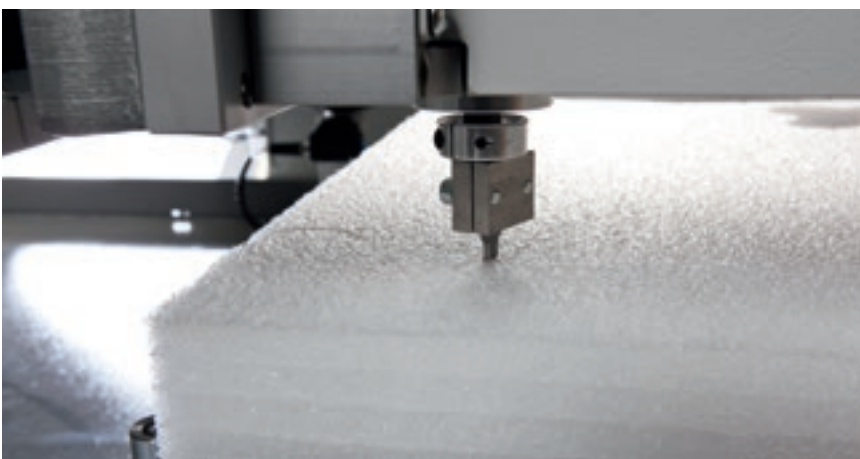

THE MOST ADVANCED TECHNOLOGY CLOSE AT HAND



BPAD

Wi-Fi control console for performing the key functions required during the preparation of the working area and the tooling of the working units and tool holder warehouses.

The bPad is a valuable tool for supporting teleservicing, courtesy of the camera and bar code reader functions.



BTOUCH

The new 21.5" touch screen which enables you to carry out all of the functions previously performed using the mouse and the keyboard, enhancing the direct interaction between the user and the device. Perfectly integrated with the bSuite 3.0 interface (and with later versions) and optimised for touch, this solution is incredibly simple, and makes the best possible use of the Biesse software functions installed on the machine.

BPAD AND BTOUCH ARE AN OPTIONAL FEATURE WHICH CAN ALSO BE BOUGHT AFTER PURCHASING THE MACHINE, IN ORDER TO IMPROVE THE FUNCTIONALITY AND APPLICATION OF THE TECHNOLOGY AVAILABLE.

INDUSTRY 4.0 READY



Industry 4.0 is the new industry frontier, based on digital technologies and on machines that speak to companies. The products driving this revolution can communicate and interact independently within production processes, which in turn are connected via intelligent networks.



Biesse is dedicated to transforming the factories owned by our customers into real-time factories that are ready to provide digital manufacturing opportunities. Intelligent machines and software become indispensable tools that facilitate the daily work of those who machine wood and other materials on a daily basis.

INDUSTRY 4.0 READY

HIGH-TECH BECOMES ACCESSIBLE AND INTUITIVE

BSOLID IS A 3D CAD CAM SOFTWARE PROGRAM THAT SUPPORTS THE PERFORMANCE OF ANY MACHINING OPERATION THANKS TO VERTICAL MODULES DESIGNED FOR SPECIFIC MANUFACTURING PROCESSES.

- Planning in just a few clicks, with endless possibilities.
- Simulating machining operations to visualise the piece ahead of manufacturing and have some guidance for the planning phase.
- Virtual prototyping of the piece to avoid collisions and ensure optimal machine equipment.





SOPHIA

GREATER VALUE FROM MACHINES



SOPHIA is the IoT platform created by Biesse in collaboration with Accenture which enables its customers to access a wide range of services to streamline and rationalise their work management processes.

It allows alerts and indicators to be sent to the customer in real time, in relation to production, the machines used and the type of process carried out. These are detailed instructions for more efficient use of the machine.

□ **10% CUT IN COSTS**

□ **50% REDUCTION
IN MACHINE DOWNTIME**

□ **10% INCREASE
IN PRODUCTIVITY**

□ **80% REDUCTION IN PROBLEM
DIAGNOSTICS TIME**

**SOPHIA TAKES THE INTERACTION BETWEEN
CUSTOMER AND SERVICE TO A HIGHER LEVEL.**

iOT
SOPHIA

IoT - SOPHIA provides a comprehensive overview of the specific machine performance features, with remote diagnostics, machine stoppage analysis and fault prevention. The service includes a continuous connection with the control centre, the option of calling for assistance from within the customer app (such calls are managed as priorities), and an inspection visit for diagnostic and performance testing within the warranty period. Through SOPHIA, the customer receives priority technical assistance.

PARTS
SOPHIA

PARTS SOPHIA is the easy new, user-friendly and personalised tool for ordering Biesse spare parts. The portal offers customers, dealers and branches the chance to navigate within a personalised account, consult the constantly updated documentation of the machines purchased, and create a spare parts purchase basket indicating the real time availability in the warehouse and the relative price list. In addition, the progress of the order can be monitored at all times.

 **BIESSE**

in collaboration with  **accenture**

TECHNICAL DATA

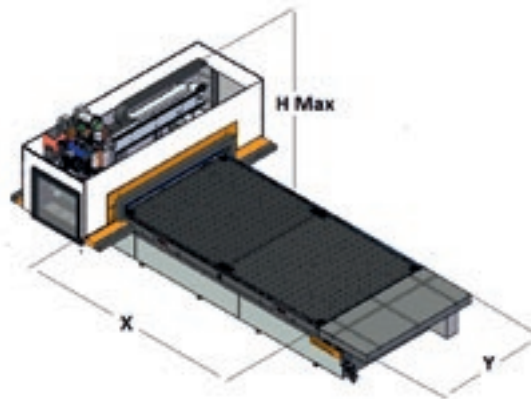

WORKING FIELD AND HEIGHT Z

	X		Y		PENDULUM WITHOUT SUSPENSION (4Ax / 5Ax)		Z		H max	
	mm	inch	mm	inch	mm	inch	mm	inch	mm	inch
Rover Plast A Smart FT 1224	2465	97	1260	50	-	-	200/250	8/10	2750	108
Rover Plast A Smart FT 1531	3100	122	1560	61	1126 / 1069	44 / 42	200/250	8/10	2750	108
Rover Plast A Smart FT 1536	3765	148	1560	61	1459 / 1401	57 / 55	200/250	8/10	2750	108
Rover Plast A Smart FT 1836	3765	148	1875	74	1459 / 1401	57 / 55	200/250	8/10	2750	108
Rover Plast A Smart FT 2231	3100	122	2205	87	1126 / 1069	44 / 42	200/250	8/10	2750	108
Rover Plast A Smart FT 2243	4300	169	2205	87	1726 / 1669	68 / 66	200/250	8/10	2750	108

SPEED

m/min - ft/min	X		Y		Z		VECTOR SPEED	
	25	82	60	197	20	66	65	213

The technical specifications and drawings are non-binding. Some photos may show machines equipped with optional features. Biesse Spa reserves the right to carry out modifications without prior notice.

Weighted sound pressure level A (LpA) during machining at the operator's workstation on the vane-pump machine LpA=79dB(A) Lwa=96dB(A) Weighted sound-pressure level A (LpA) at the operator's workstation and sound power level (LwA) during machining on the cam-pump machine Lwa=83dB(A) Lwa=100dB(A) Measurement uncertainty K dB(A) 4.

The measurement was carried out in compliance with UNI EN 848-3:2007, UNI EN ISO 3746: 2009 (sound power) and UNI EN ISO 11202: 2009 (sound pressure levels at workstation) during panel machining. The noise levels shown are emission levels and do not necessarily correspond to safe operation levels. Despite the fact that there is a relationship between emission and exposure levels, this may not be used in a reliable manner to establish whether further measures need to be taken. The factors determining the exposure level for the workforce include length of exposure, work environment characteristics, other sources of dust and noise, etc. i.e. the number of other adjoining machines and processes. At any rate, the above information will enable the operator to better evaluate dangers and risks.

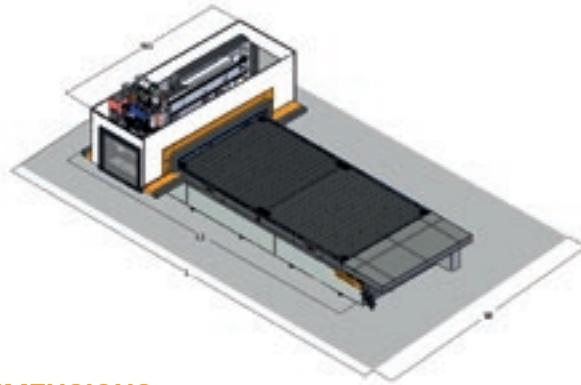

OVERALL STAND-ALONE DIMENSIONS

ACCESS FROM ALL SIDES	L		L1		W		W1	
	CE / NCE		CE / NCE		CE / NCE		CE / NCE	
	mm	inch	mm	inch	mm	inch	mm	inch
Rover Plast A Smart FT 1224	6380	251	5379	212	4136	163	3136	123
Rover Plast A Smart FT 1531	7020	276	6019	237	4436	175	3436	135
Rover Plast A Smart FT 1536	7680	302	6680	263	4436	175	3436	135
Rover Plast A Smart FT 1836	7680	302	6680	263	4752	187	3752	148
Rover Plast A Smart FT 2231	7020	276	6019	237	5082	200	4082	161
Rover Plast A Smart FT 2243	8210	323	7215	284	5082	200	4082	161

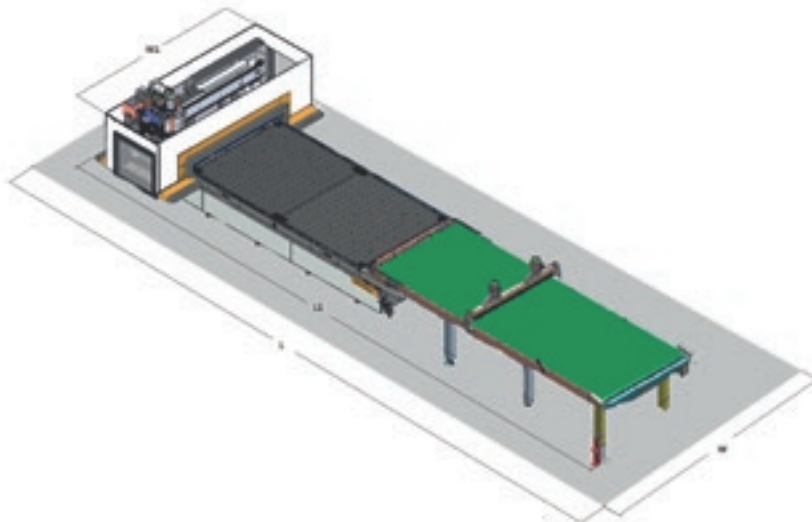

OVERALL DIMENSIONS OF UNLOADING BELT ONLY

ACCESS FROM ALL SIDES	L		L1		W		W1	
	CE / NCE		CE / NCE		CE / NCE		CE / NCE	
	mm	inch	mm	inch	mm	inch	mm	inch
Rover Plast A Smart FT 1224	8680	342	7779	306	4136	163	3136	123
Rover Plast A Smart FT 1531	9870	389	8965	353	4436	175	3436	135
Rover Plast A Smart FT 1536	11210	441	10306	406	4436	175	3436	135
Rover Plast A Smart FT 1836	11210	441	10306	406	4752	187	3752	148
Rover Plast A Smart FT 2231	9870	389	8965	353	5082	200	4082	161
Rover Plast A Smart FT 2243	12270	483	11367	448	5082	200	4082	161

SERV ICE & PARTS

Direct, seamless co-ordination of service requests between Service and Parts. Support for key customers from specific Biesse personnel, in-house and/or at the customer's site.

BIESSE SERVICE

- ▣ Installation and start-up of machines and systems.
- ▣ Training centre for Biesse Field technicians, branch and dealer personnel, and training directly at customer's site.
- ▣ Overhaul, upgrade, repair and maintenance.
- ▣ Remote diagnostics and troubleshooting.
- ▣ Software upgrade.

500

Biesse Field engineers in Italy and worldwide.

50

Biesse engineers manning a Teleservice Centre.

550

certified Dealer engineers.

120

training courses in a variety of languages every year.

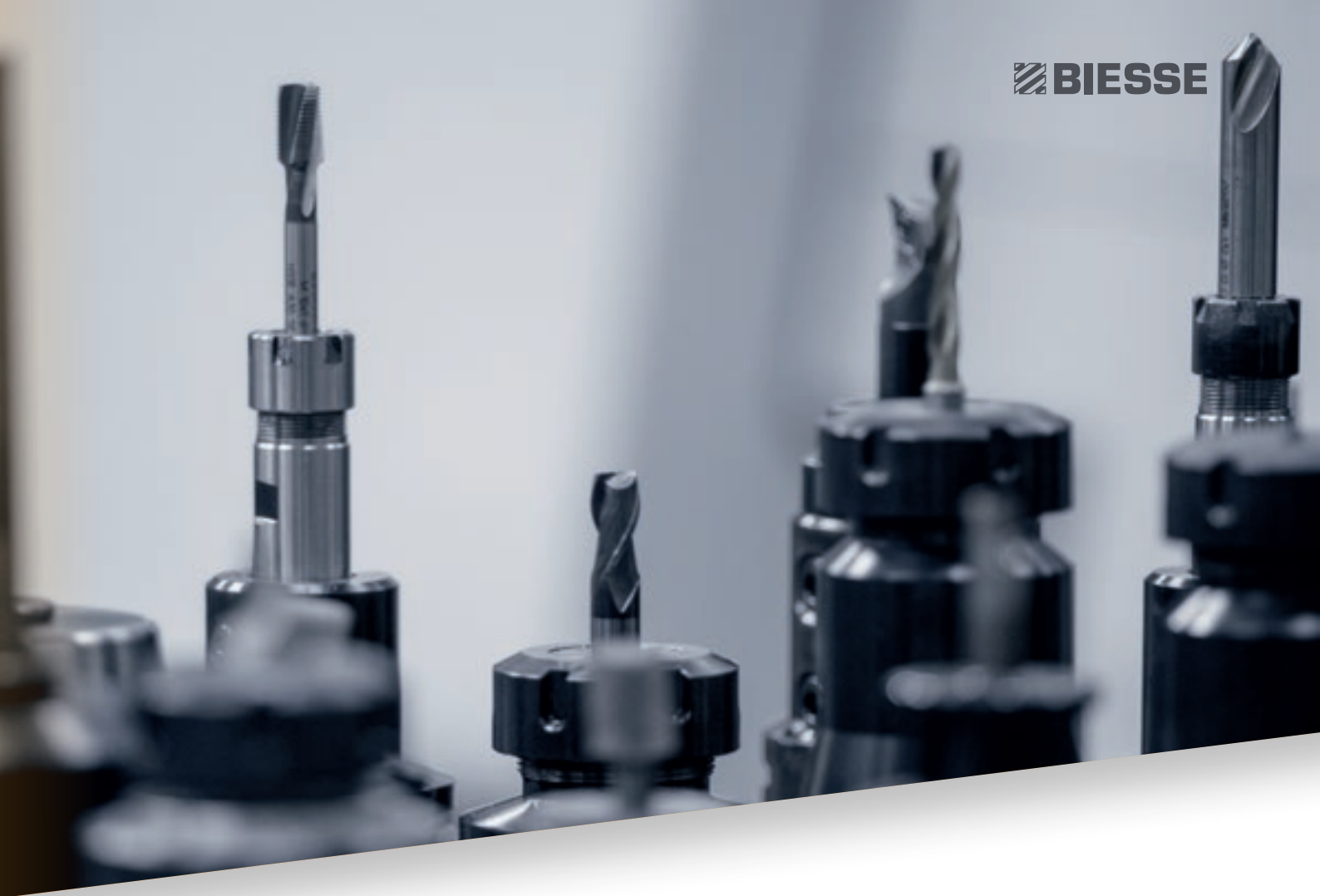
A close-up photograph of several metal drill bits and tool components, arranged in a row. The bits are of different sizes and designs, some with standard double-flute and others with more complex, multi-fluted designs. They are set against a blurred background, highlighting their metallic texture and sharp edges.

The Biesse Group promotes, nurtures and develops close and constructive relationships with customers in order to better understand their needs and improve products and after-sales service through two dedicated areas: Biesse Service and Biesse Parts. With its global network and highly specialised team, the company offers technical service and machine/component spares anywhere in the world on-site and 24/7 on-line.

BIESSE PARTS

- Original Biesse spare parts and spare kits tailored to each machine model.
- Spare part identification support.
- Offices of DHL, UPS and GLS logistics partners located within the Biesse spare part warehouse, with multiple daily pick-ups.
- Order fulfillment times optimised thanks to a global distribution network with delocalised, automated warehouses.

92%
of downtime machine orders fulfilled within 24 hours.

96%
of orders delivered in full on time.

100
spare part staff in Italy and worldwide.

500
orders processed every day.

MADE WITH BIESSE

BIESSE TECHNOLOGY AND CREATIVITY BY ACTION GIROMARI

Action Giromari is a creative workshop that has been working with laser branding and engraving for over 20 years. Developed at a time when globalisation and, to some extent, standardisation were hallmarks of the global culture and economy, the company offered the market a chance to preserve and strengthen the personal aesthetic of creatives, designers and companies. The company stands out for its ability to work with any type of material.

"We don't develop a single category of products. Rather, thanks to the wide variety of materials we work with and the varied technologies we use, we are able to tailor any project, both for small scale and mass production. We develop stands, signs, branding products and anything that relates to visual communication. Other products include coverings, countertops and custom made

interior design products for stores. We also work with several architects, who send us their designs. Our clients mainly ask us to design and create products that highlight their identity as a company to help them stand out on the market through creativity and design," Raffaele Bastianoni, the company owner, explains.

Action Giromari handles every phase of production itself, from prototyping to engineering to packaging, every single step is inspected first hand. Numerical control technology allows Action Giromari to cut, mill, score and shape each piece. The steps that follow (assembly, gluing...) all the way to final finishing, are exclusively carried out by hand.

"Biesse technology plays a key role in allowing us to be more versatile and offer ad hoc solutions. Thanks to the new Rover Plast M5 purchased in May 2016

we have increased our production of complex shapes and 3D objects: unique products that have great value on the market. When we chose Biesse, an Italian company that offered reliability and know how, we weren't simply interested in the new numerical control milling cutter, rather we acquired a veritable partnership.

We consider Biesse a strategic partner for Giromari's technological development" Bastianoni says in closing.



MACHINING CENTRES RANGE

CNC - PLAST



ROVER PLAST J FT



ROVER PLAST A SMART FT



ROVER PLAST A FT



ROVER PLAST B FT



ROVER PLAST M5

VERTICAL MACHINING CENTRE



BREMA PLAST EKO 2.1



MATERIA CL



MATERIA LD



MATERIA FC



MATERIA MR



MATERIA XA-XB-XC

CNC - MATERIA

PANEL SAWS



SELCO PLAST SK4



SELCO PLAST WN 6



SELCO PLAST WN7

WATERJET CUTTING SYSTEMS



PRIMUS PLAST 184



PRIMUS PLAST 202-322-324-326-402



TERMA

THERMOFORMING

SANDING



VIET PLAST S211-S1-S2



VIET PLAST OPERA 5 - OPERA 7 - OPERA R



VIET PLAST NARROW



VIET PLAST VALERIA

HANDLING



WINSTORE

LIVE THE EXPERIENCE

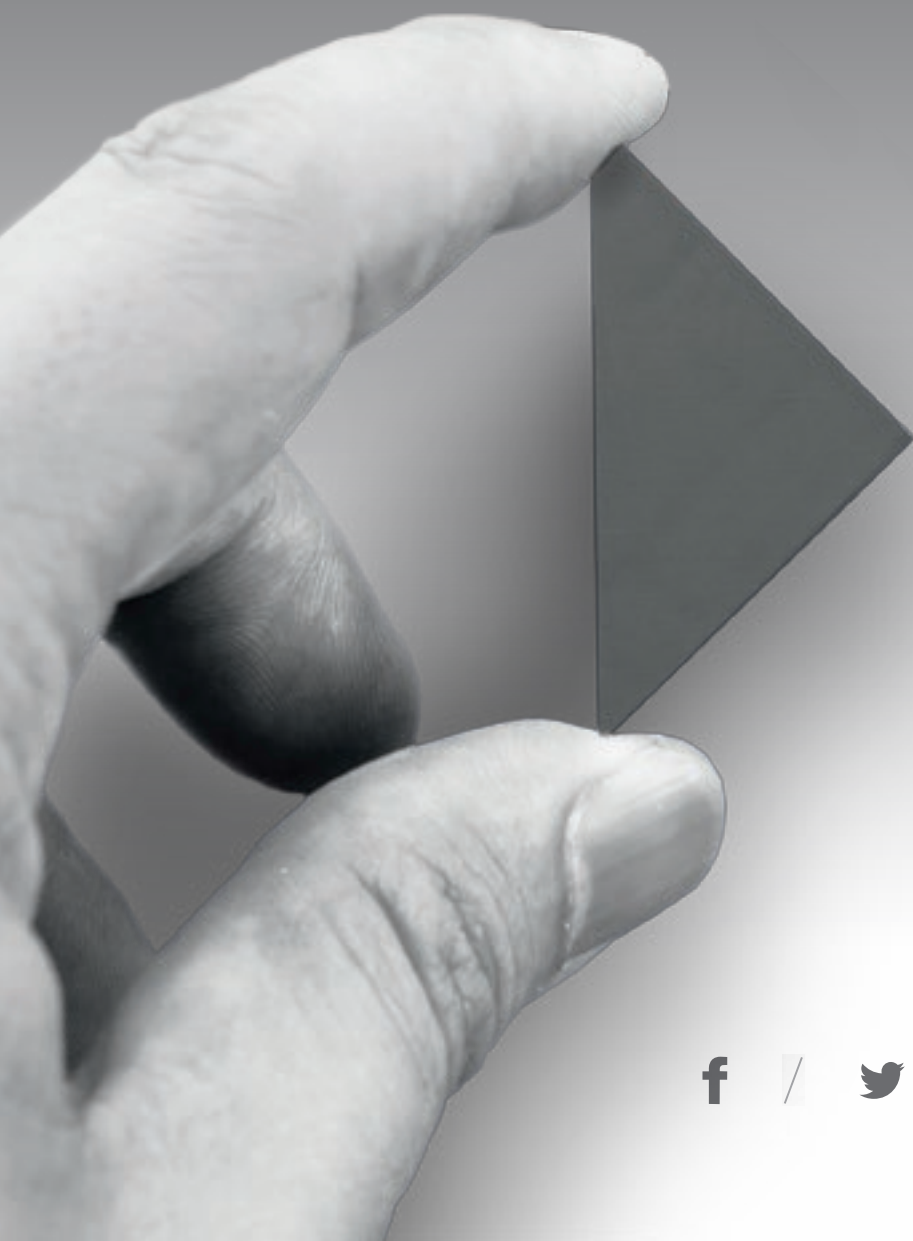

BIESSEGROUP.COM



E



Interconnected technologies and advanced services that maximise efficiency and productivity, generating new skills to serve better our customer.

LIVE THE BIESSE GROUP EXPERIENCE AT OUR CAMPUSES ACROSS THE WORLD.

 **BIESSEGROUP**

