

# STREAM C

BI-LATERAL SQUARING  
AND EDGEBANDING MACHINES

 **BIESSE**

 YEARS  
 **BIESSEGROUP**

# THE TECHNOLOGICAL CHOICE FOR SQUARE-EDGING

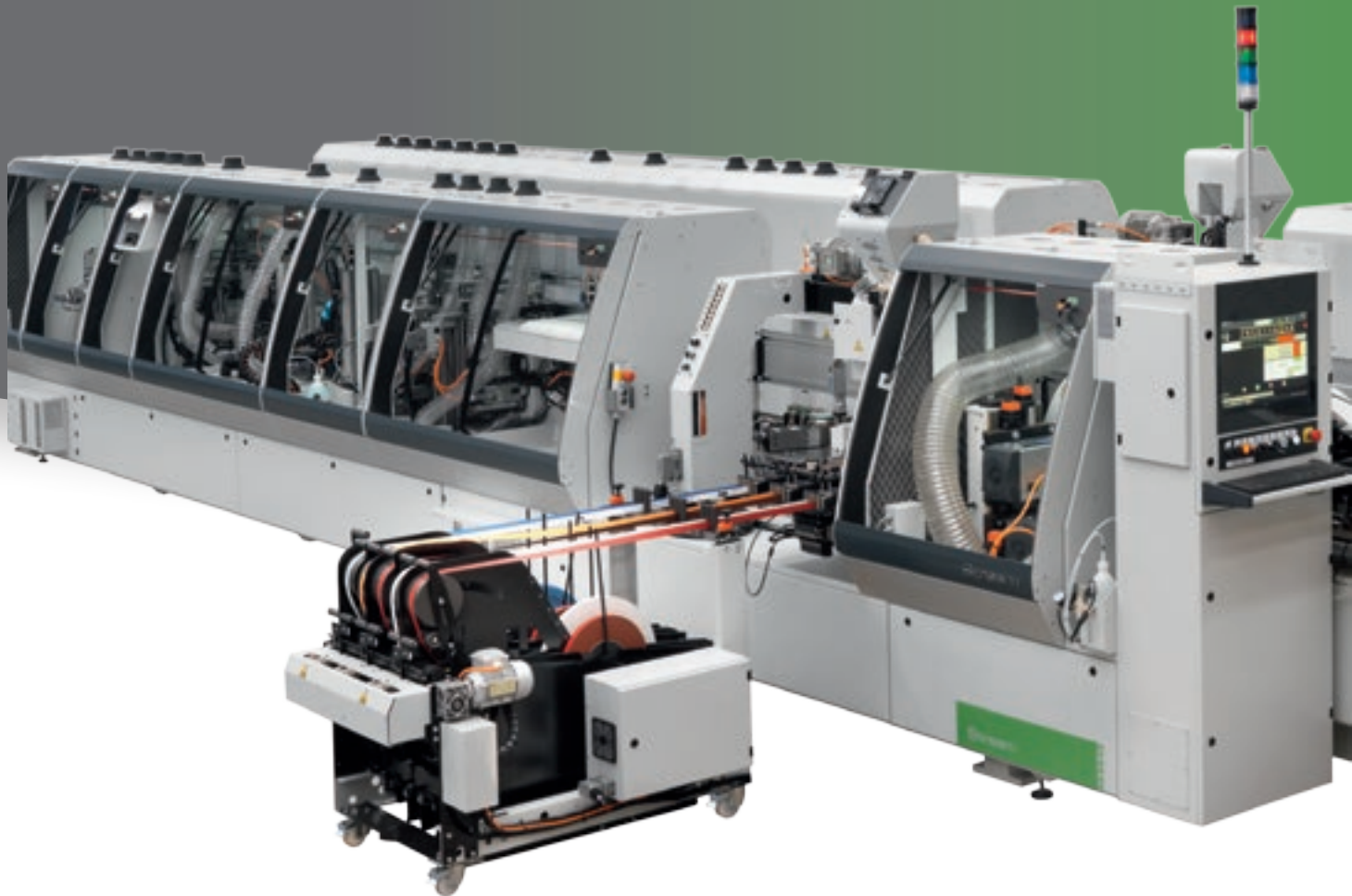

## THE MARKET DEMANDS

a change in manufacturing processes, enabling companies to **accept the largest possible number of orders**. This is coupled with the need to maintain high quality standards while offering product customisation with quick and defined delivery times, as well as responding to the needs of the most highly automated enterprises.

## BIESSE RESPONDS

with **technological solutions** that guarantee high quality, consistent performance which lasts over long periods of time. **Stream C** is the range of square and edgebanding machines which enables both squaring and edgebanding operations to be carried out using a single system, on both the transverse and longitudinal sides of a panel. These reliable, high-performance machines deliver high levels of productivity.



## STREAM <sub>C</sub>

- ▶ MAXIMUM RESULTS WITH A REDUCTION IN THE MACHINES USED
- ▶ PERFECT GLUING SURFACE
- ▶ SUPERB PERFORMANCE AND EXECUTION OF OPERATIONS COURTESY OF SPECIFIC SOLUTIONS DESIGNED FOR PREPARING THE PANEL FOR THE SUBSEQUENT MACHINING PHASES
- ▶ UNITS DEVELOPED TO MEET ALL FLEXIBILITY AND PRODUCTIVITY REQUIREMENTS

# MAXIMUM RESULTS WITH A REDUCTION IN THE MACHINES USED

Squaring and edgbanding machines have become essential machines for modern woodworking.

The Biesse Stream C range is designed to ensure maximum efficiency. A number of solutions are available to meet a host of production needs.



## STREAM C BD2

This dual stand-alone machine enables both the longitudinal and transverse side of the panel to be machined, at a rate of up to 30 m/min, with a removal capacity of up to 6 mm on both sides. The first passage wheel enables the longitudinal side of the panel to be aligned and centred. The extended machine input area allows the transverse side of the panel to be inserted, pushed by the bolts that ensure the parallel alignment previously obtained when machining the longitudinal side is maintained, thus ensuring that the dimensions of the finished panel are perfect.



Panel output area.



## STREAM C SB1

This line machine can work at a rate of up to 60 m/min., enabling a total of up to 10 mm to be removed on both sides. It has a short input area designed for receiving the longitudinal side of the panel, aligned with the first passage wheels.



Panel input area.



## STREAM C SB2

This line machine can work at a rate of up to 40 m/min., enabling a total of up to 10 mm to be removed on both sides. It was designed for machining operations on the transverse side of the panel, but can also be equipped with various options that also enable the longitudinal side of the panel to be machined.

# PRO DUCTI VITY



## SQUARING AND EDGBANDING SOLUTIONS

The Biesse Stream C range is designed to ensure maximum production efficiency. Reliable and performance-focused, this machine is equipped with a host of technological solutions designed to meet specific requirements, whilst responding to the highest productivity demands.

Biesse squaring and edgbanding machines feature a rigid, reliable monolithic base, ensuring high levels of precision throughout the life of the machine, reducing the risk of vibration to zero. The rolling belt guarantees maximum reliability even at high working speeds. Thanks to the special profile of the chain links and the exclusive APS (Anti Pulsing System) system, flexion is reduced to nil. The highperformance machining units ensure minimal spacing between panels for high productivity.



# AT THE HEART OF QUALITY

The structure of the machine is extremely robust and rigid, sized with cutting edge calculation and design tools. A quality control system for our entire range of industrial processes ensures product compliance. Each machine undergoes around 160 checks during the assembly stage in order to simulate the most challenging working conditions.



The **Monolithic Base** provides high stability and allows the machine to operate 24 hours a day, 7 days a week whilst continuing to deliver high quality standards.



Each base has a tolerance of 2 hundredths of millimetre per linear meter. In this way, apart from guaranteeing the quality of engineering, it is possible to eliminate the need for any remedial work during the assembly phase, which would inevitably delay the machine's delivery.





The **belt presser** enables the passage of the panel on the belt, exerting the ideal pressure in a uniform manner, even for the most delicate coatings.



The **first passage wheels** are designed to guarantee the perfect alignment of the longitudinal side of the panel, through constant pressure on the three rubber wheels.



The **centring device** enables the panel to be centred, for machining the transverse side thereof.

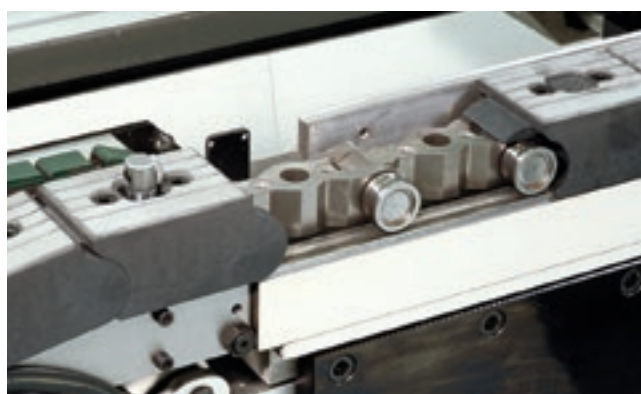

The **stop bolts**, made from toughened ground steel with chrome coating, push the panel forwards, inserting it at 90° on the transverse side, using the parallel alignment previously obtained when machining the longitudinal side. The feed belt is made from a high-precision chain with minimum deformability, with adjustable speed settings to ensure that it runs smoothly in a linear manner, for maximum precision and stability.

# CAN BE CUSTOMISED ACCORDING TO PRODUCTION NEEDS

Stream C can be configured to suit customers with an endless number of possibilities.

Preparation of the panel



Double Hogging Unit



Pre-milling Unit



Gluing of edgebanding strip

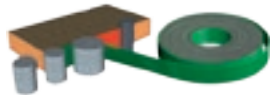

Gluing Unit



Edgebanding strip machining operations



End Trimming Unit

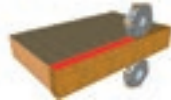

Overlapping Rough Trimmer Unit

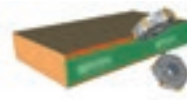

Fine Trimming Unit



Corner Rounding Unit



Panel machining operations

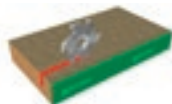

Grooving Unit



Edgebanding strip finishing

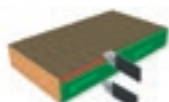

Edge scraper Unit

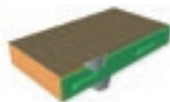

Glue scraper Unit

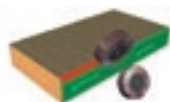

Buffing Unit

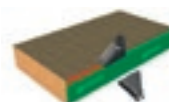

Hot Air Blower

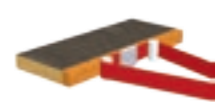

Sanding Unit



# PERFECT GLUING SURFACE

The preparation of the panel before gluing is an important stage in order to achieve perfect edging. The units dedicated to this phase are designed to ensure high precision across each of the subsequent machining operations.



The **double hogging unit** enables the panel to be squared, removing up to 5 mm of material from each side.





The **anti-splinter** device enables squaring operations to be performed on the transverse side without damaging the longitudinal side that has already been machined.



The **2-motor RT20 pre-milling** unit with automatic intervention guarantees a perfect base for gluing. New optimisation of the suction system guarantees optimum cleaning.

# OPTIMAL EDGE ADHESION

The Biesse gluing units are designed to ensure optimum application of adhesive on the edge of the panel. A range of different models are available depending on machining requirements.

Gluing unit for the automatic application of edging in rolls or strips, from 0.4 to 20 mm. It comes with dedicated movement on glue roller, strip loading roller and pressure roller as standard.

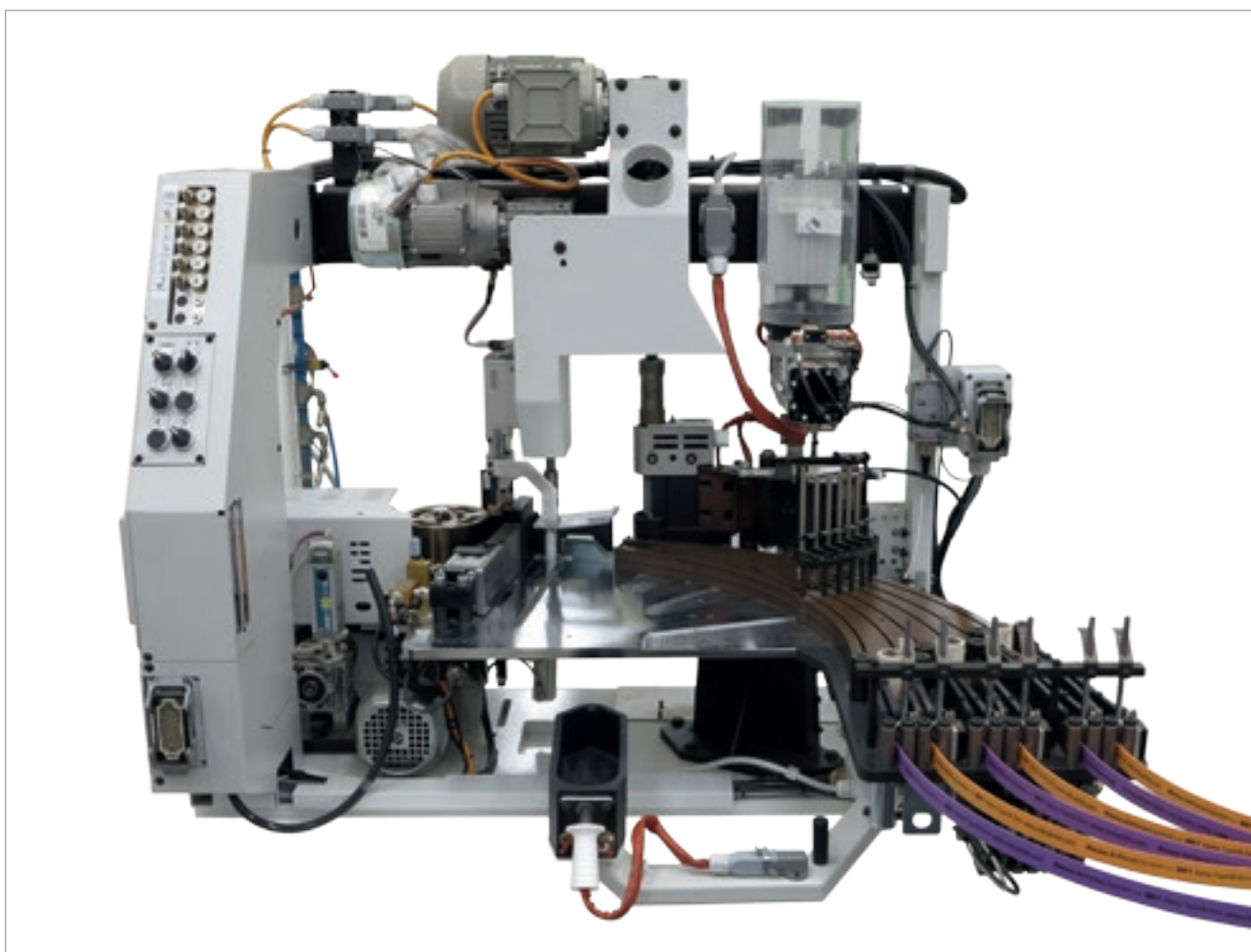

## SP10

Used to apply edging in rolls from 0.4 to 3 mm and covers most machining requirements.

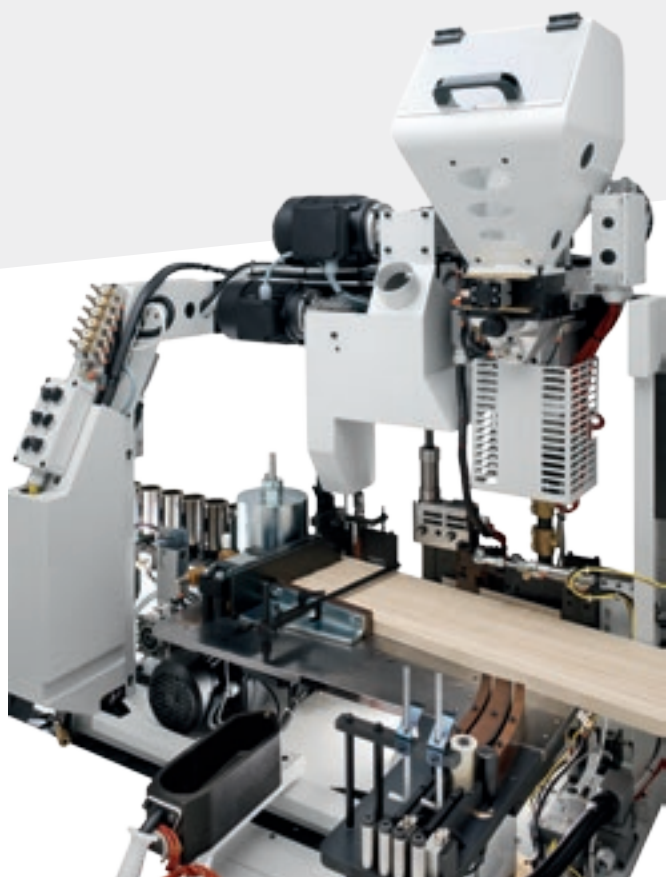

### SP20

Unit specifically for machining up to 20 mm thick solid wood edging in rolls or strips.



### SP30

The ideal solution for machining that requires high speed and rapid setup times.

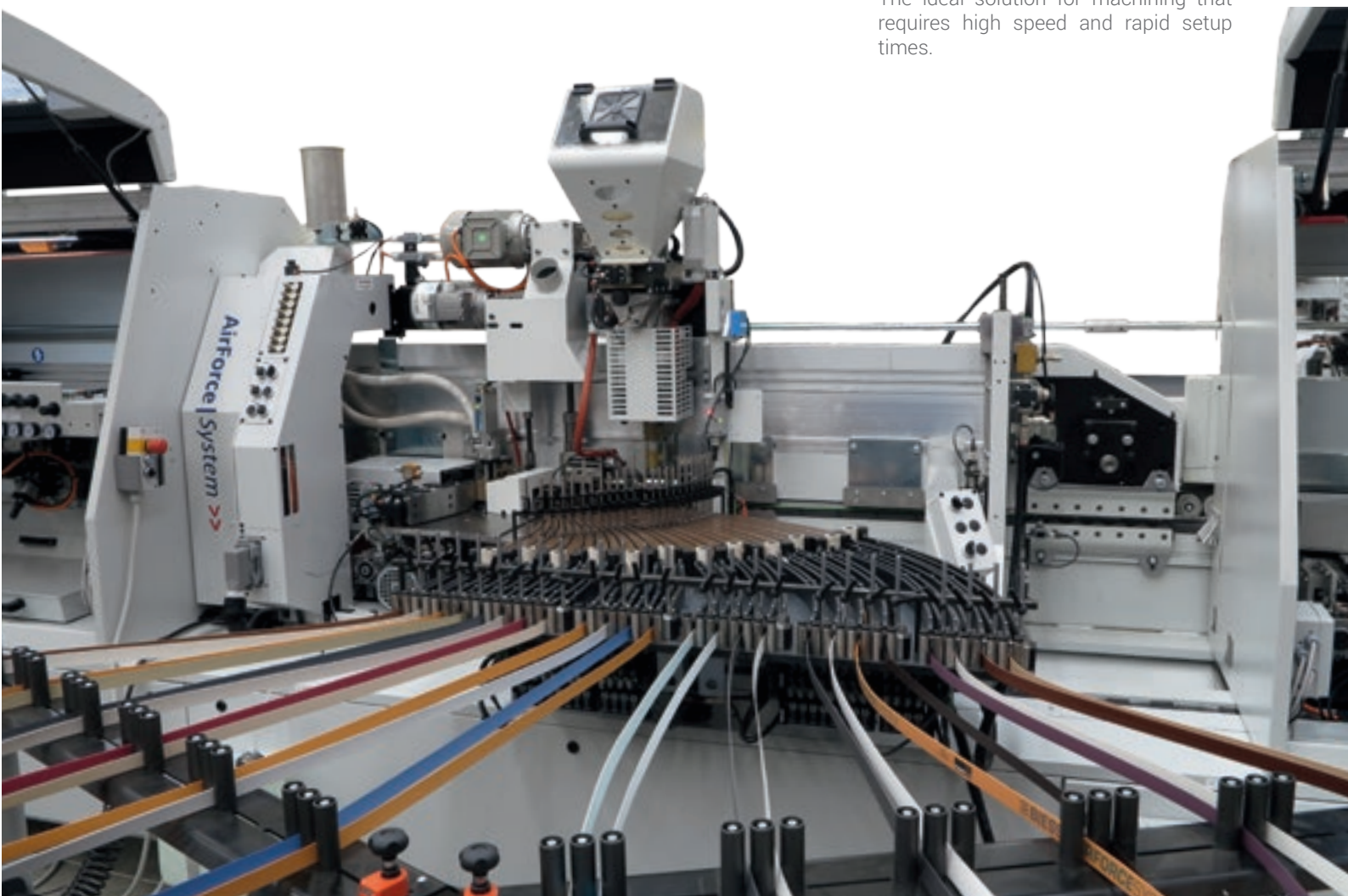

# A HOST OF SOLUTIONS FOR OPTIMUM GLUE MANAGEMENT

Biesse offers a range of specific solutions for the use of Evo and polyurethane glues.



Thanks to a **magazine** that can house a wide combination of edges, the unit guarantees unprecedented flexibility.





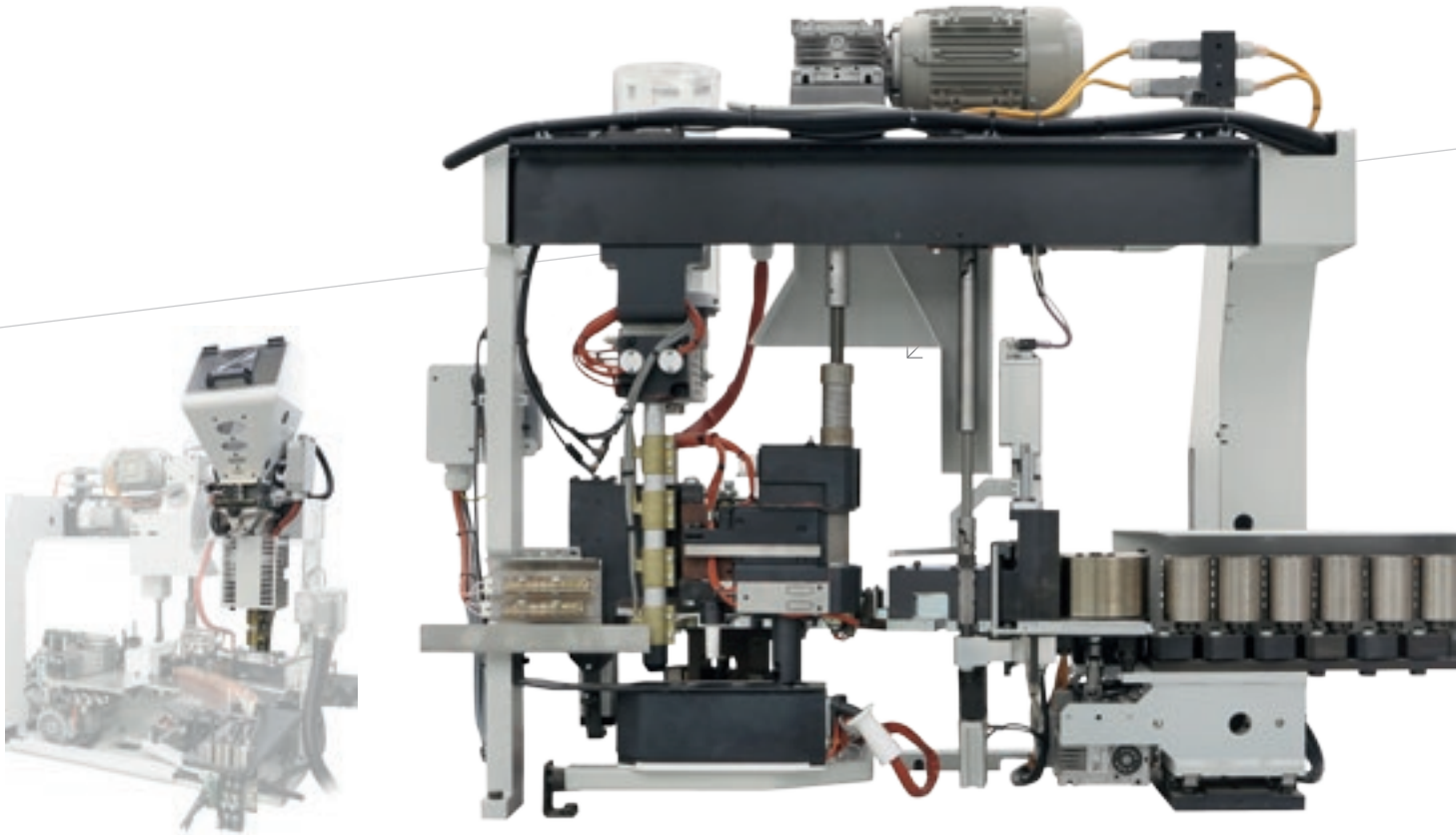

The **HM20 Pre-melter** is a pot for glue in granular form that boasts a large capacity, for constant machining for long periods in full autonomy.

**High Melt** is a Biesse-patented continuous glue recycling system that keeps the machine clean without burning the glue.



The **Nordson pre-melters** are systems created for use with Pur adhesives, and are designed to meet high production needs. These exclusive direct-injection systems are conceived for non-stop high-consumption machining at sustained speeds.



Glue chuck maintenance station:  
 - Can be accessed to carry out maintenance on the chucks  
 - Specific temperature control according to the type of glue (EVA/PUR)  
 - Dedicated glue roller drive

# AIR FORCE SYSTEM

## INVISIBLE EDGEBANDING

**No joints and no glue line, in perfect harmony with the panel.**

Air Force System, available on Biesse edgebanding machines, is based on the physical principle of convection. By using a compressed hot air system, the edge bonds perfectly with the panel guaranteeing resistance to water and heat and an excellent long lasting quality finish.



# FOR SUPERB PERFORMANCE AND EXECUTION

Specific solutions developed for preparing the panel for the subsequent machining phases, guaranteeing maximum precision.



## IT90P

The **IT90P**, a linear edge trimming unit with stepper movement for higher speeds, enables work rates of up to 30 m/min.



MAXIMUM CUTTING QUALITY AND PRECISION THANKS TO THE END TRIMMING UNIT, WHICH ENABLES ANY EXCESS TO BE ELIMINATED AT BOTH ENDS OF THE PANEL. VARIOUS SOLUTIONS AVAILABLE FOR DIFFERENT MACHINING REQUIREMENTS.



The **IT90X** linear edge trimming unit with brushless movement for high speed operations enables work rates of up to 42 m/min.



The copying and tracing system also guarantees optimal finishing quality on high-gloss edges with film. The 3 pneumatic positions of the front thickness tracer can be used to control the finishing of 3 different edge thicknesses.



# ADVANCED TRIMMING

Customised solutions derived from in-depth knowledge of the machining process, designed to provide solutions tailored to a host of different requirements.

The **Rough Trimmer** reduces the excess edge on the top and bottom of the panel. It also guarantees a perfect finish for solid wood, in one single movement.

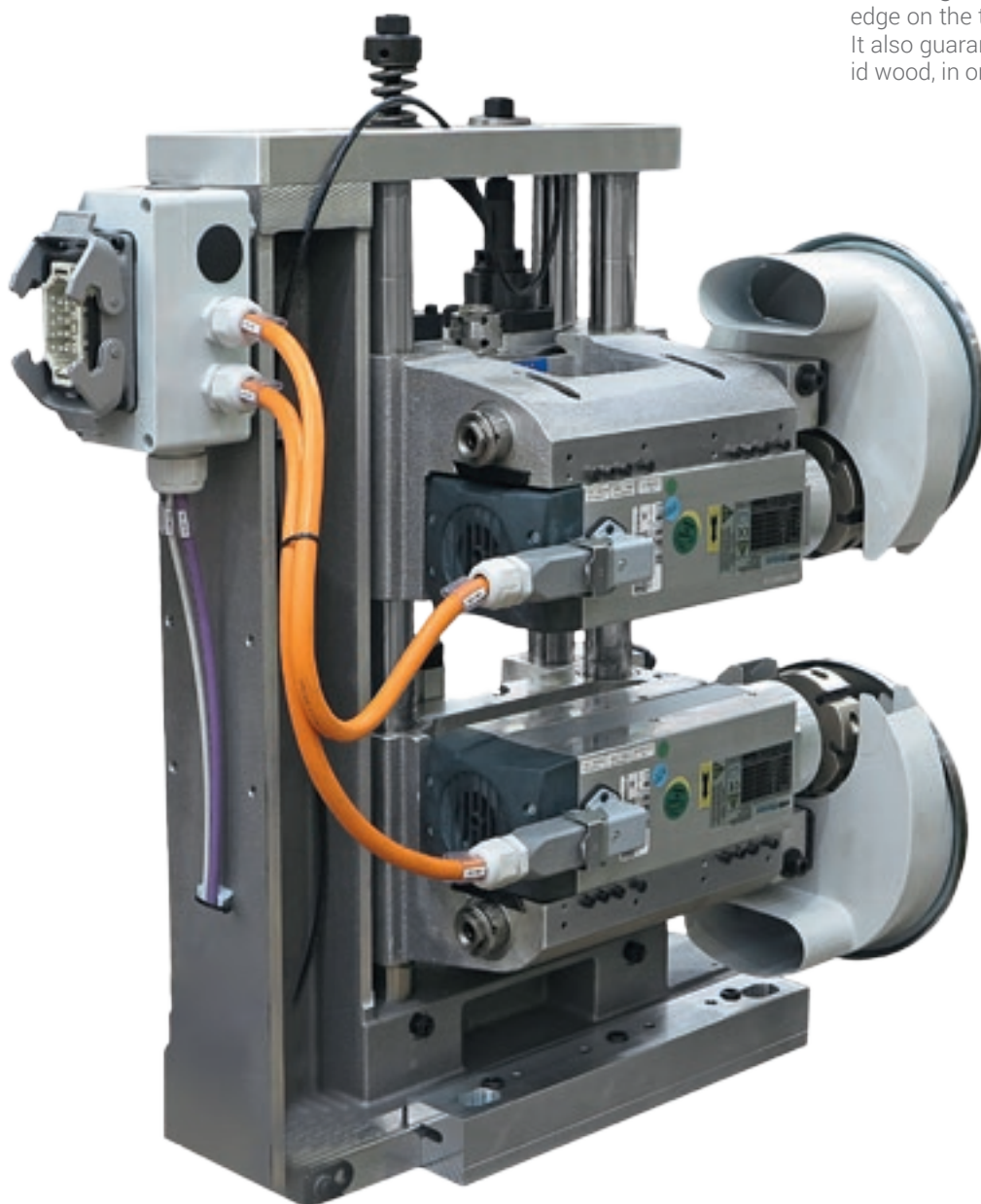

The Fine Trimming Unit for edge trimming is one of the core units in the edgebanding process, with 2 high-frequency motors and vertical/front rotating disc copiers.

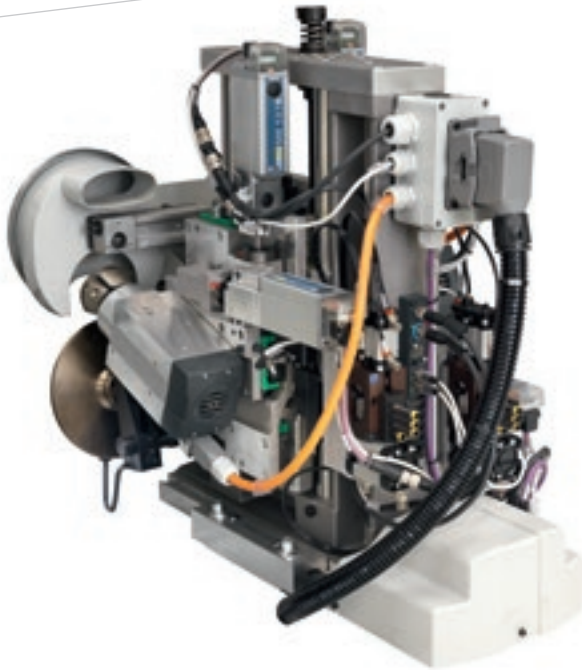
**RF40**

Full machining setting autonomy. The ideal solution for users who require absolute machining flexibility, thanks to full adjustment of the machine to the required edge thickness.

**New RF50**

Top quality thanks to the high-frequency motors (24000 rpm) and diamond-head mills.

Thanks to the 7 axes with NC control, the tool position can be adapted to even the slightest variations in the edgebanding strip and panel.

# SOLUTIONS FOR EVERY REQUIREMENT

Solution created to meet the productivity and flexibility needs of the most demanding manufacturers.

The multi-function corner rounding unit enables radiusing to be applied on both the front/rear and top/bottom edges.

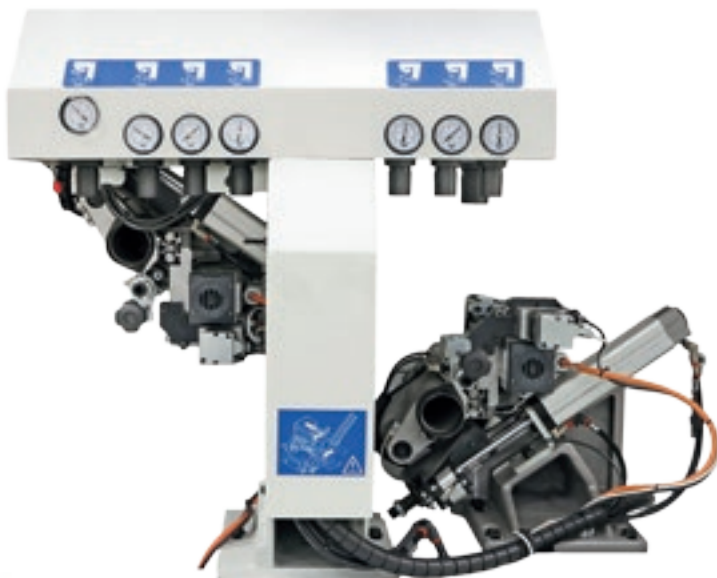

**AR30**  
2-motor pneumatic tracking corner-rounding unit.



**AR34**  
4-motor pneumatic tracking corner-rounding unit. Ideal for rounding wood edges.



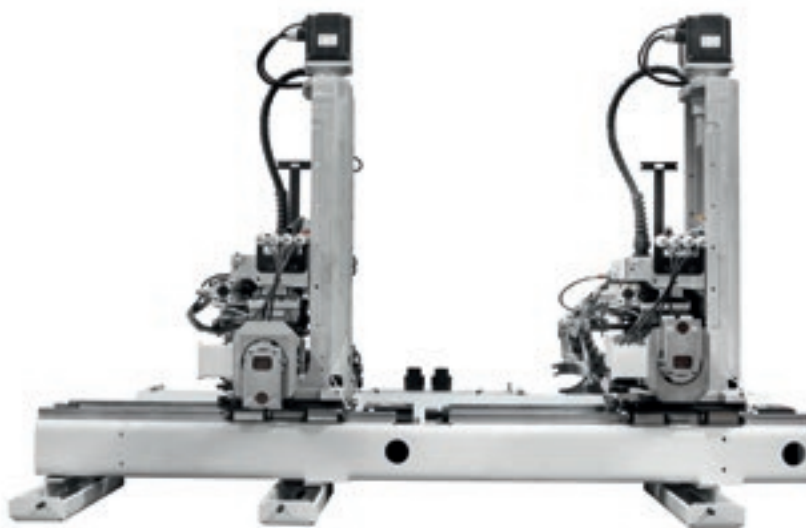

**AR80**  
2-motor corner-rounding unit with brushless movement for high machining speeds and maximum quality and precision.

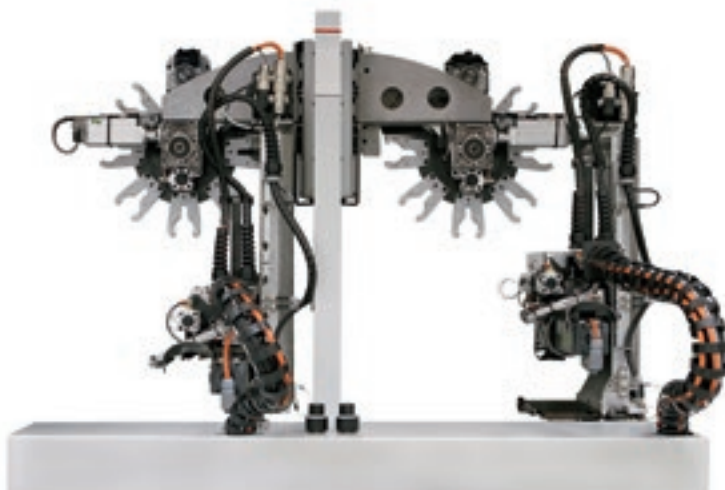

**Tool change magazine**  
Reduction in cycle times thanks to automatic tool change for machining edges of different thicknesses.

# A WIDE RANGE OF MACHINING OPTIONS

Stream C technology can be used for complex machining operations, guaranteeing quality, precision and absolute reliability over time.

The grooving unit can be used for grooving and milling on the bottom, top and front surface of the panel.



## FB30

Unit with manual movement and positioning of the unit with 0-90° rotation.



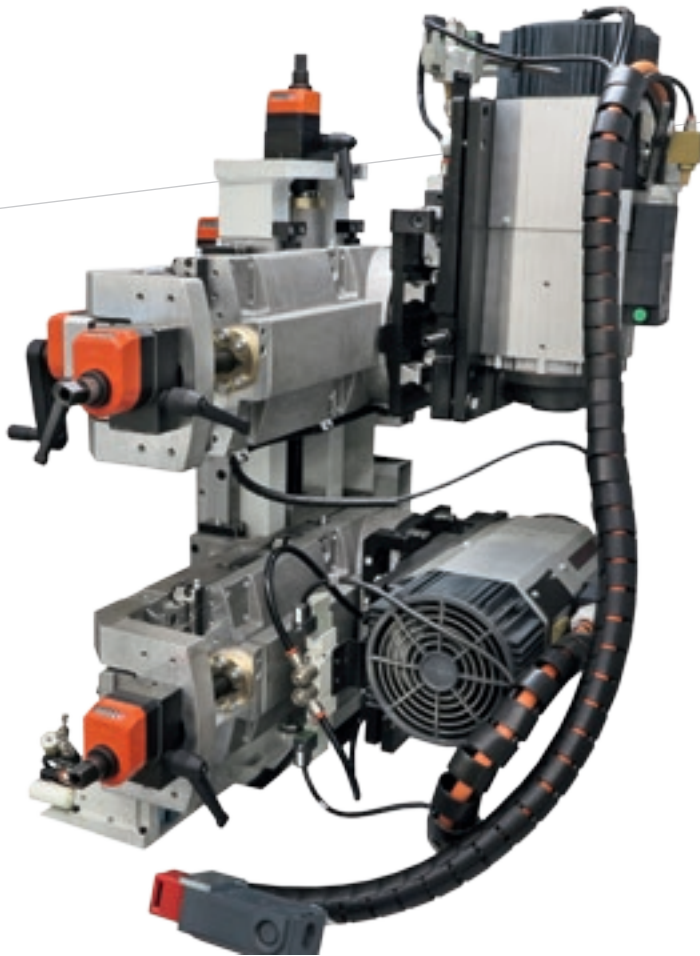

## EB32

Equipped with a double carriage to make a channel simultaneously on the bottom and front surface of the panel.

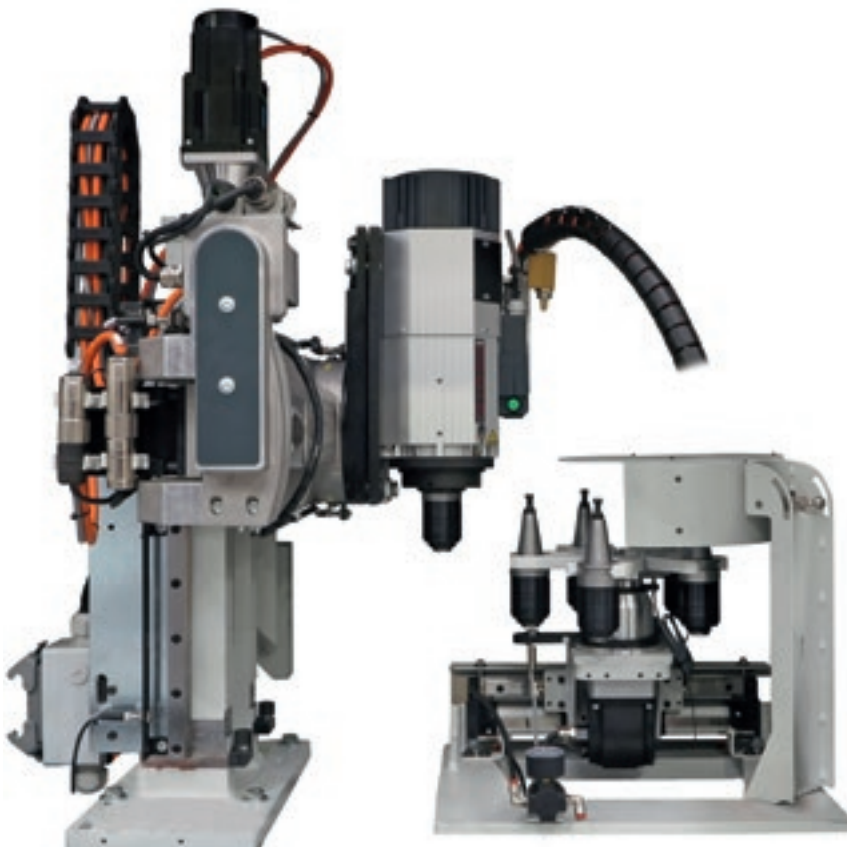

## EB60

Brushless servo-controlled axis electro-spindle and grooving unit. It provides extreme precision in a timed drive context. The Tool Magazine has 5 compartments for automatic NC tool changing.

# PERFECT FINISHING

The edge scraper eliminates any imperfections from previous machining operations on the top and bottom of the edge.



Compact machining unit with the management of 2 profiles with pneumatic settings.

The edge scraper unit maintains excellent quality standards even at high working speeds.



The axes on the edge-scraper unit enable automatic positioning in an unlimited range of positions, in accordance with the thickness of the edgebanding strip.

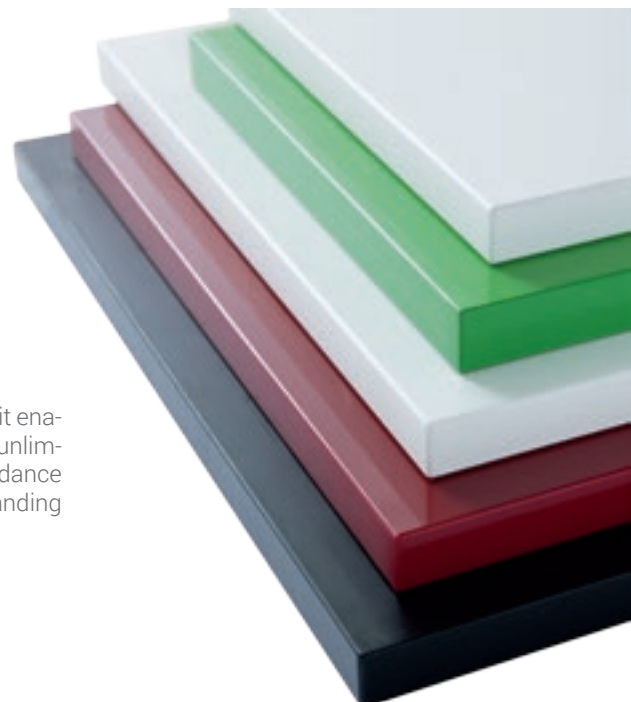

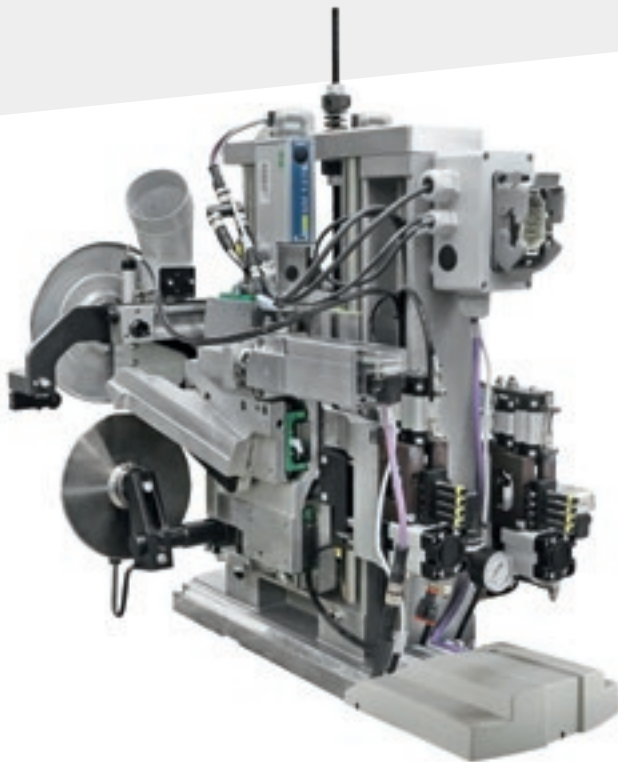

## RB40

Positioned on the column for the complete absorption of any vibration generated on the structure, with the multiple management of controlled-axis profiles for infinite settings.



## Pro-Nesting Kit

Ideal solution for edge banding of pre-drilled panels.



## New RB50

Maximum flexibility thanks to one single tool for machining up to 5 different profiles.

Thanks to the 7 axes with NC control, the tool position can be adapted to even the slightest variations in the edgebanding strip and panel.

# OPTIMUM CLEANING OF FINISHED PRODUCT

Multiple solutions for guaranteeing high-quality product standards.



The **Glue Scraper** removes excess glue from the top and bottom of the panel. This is the only model on the market fitted with 4 pneumatic cylinders for a top quality finish.





**Buffing Unit** for cleaning and polishing the edge and panel.



Panel cleaning system consisting of a set of liquids with different functions, in accordance with the various machining phases. The system ensures that the finished product does not require further cleaning.



**Hot air blower** for reactivating the colour of the edges.



# SOFTFORMING MACHINING OPERATIONS FOR DESIGN PRODUCTS

Biesse develops state-of-the-art technologies for edgebanding even the most complex shapes.

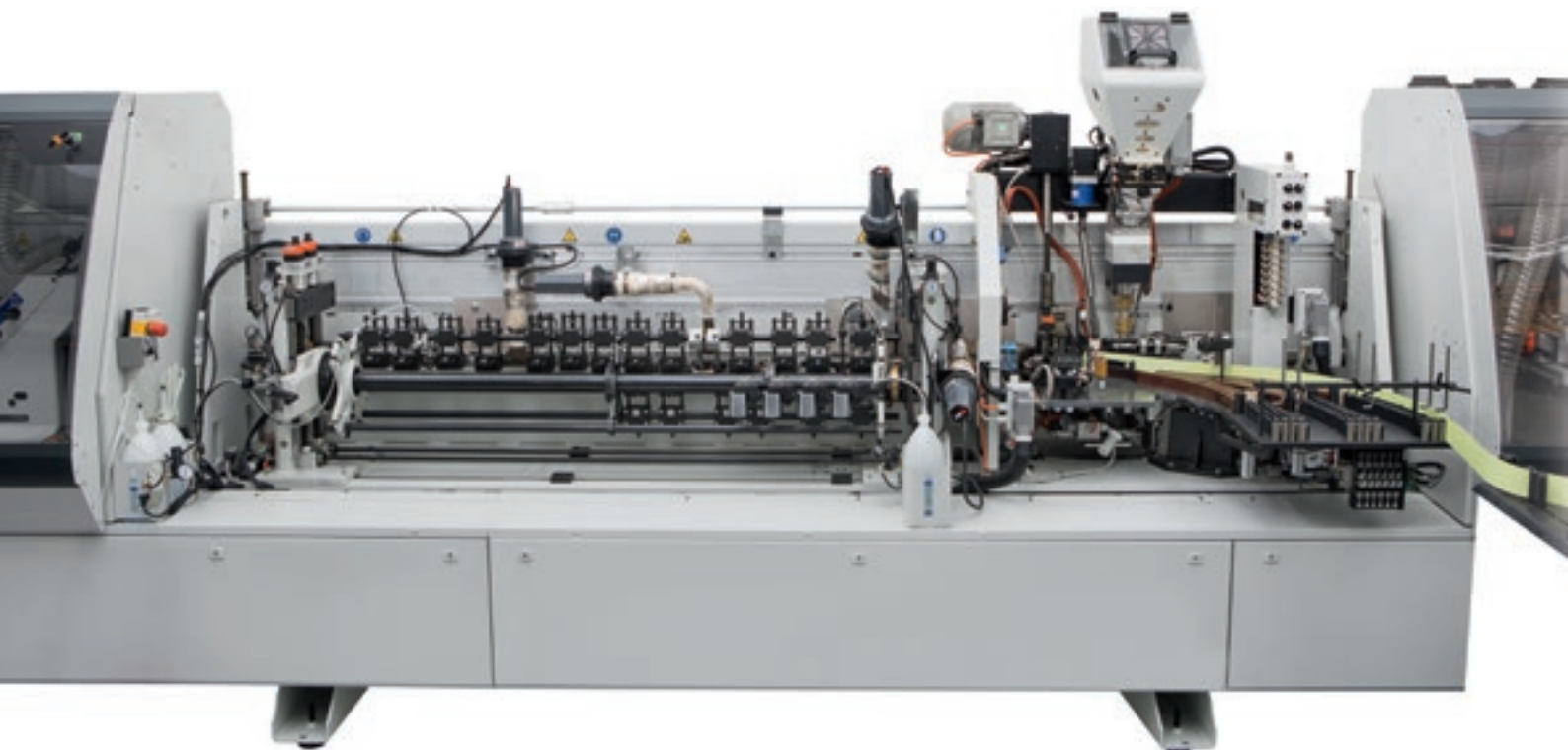



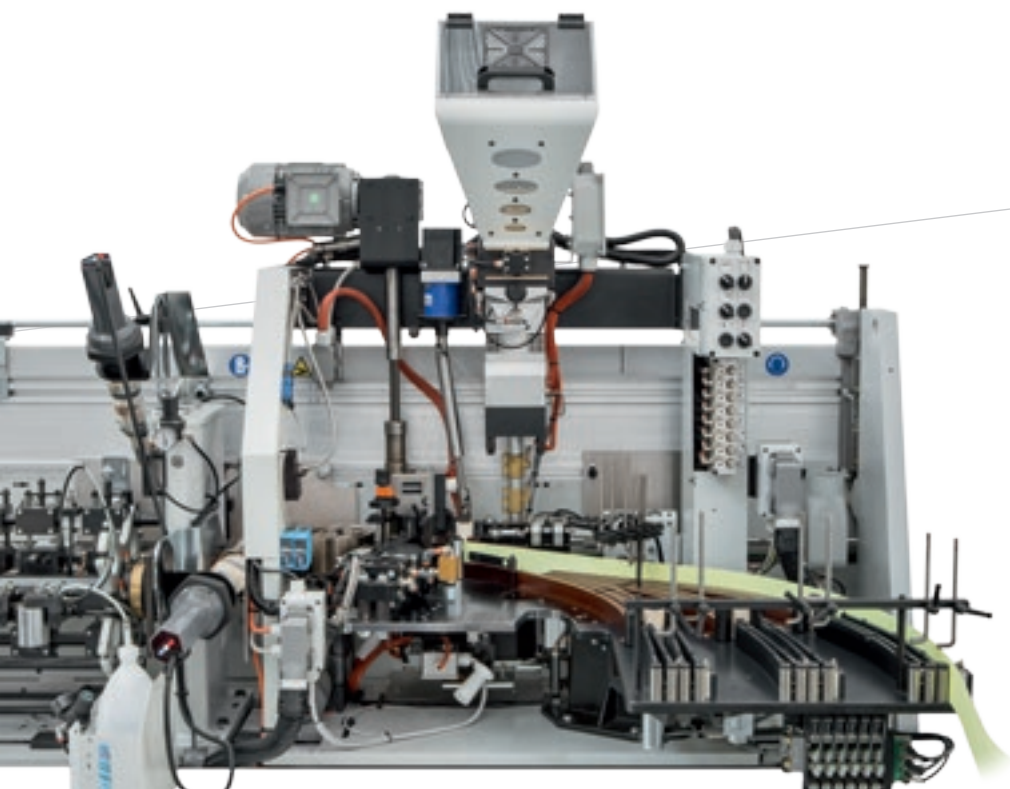

**SP40 gluing unit** for softforming shaped edges.

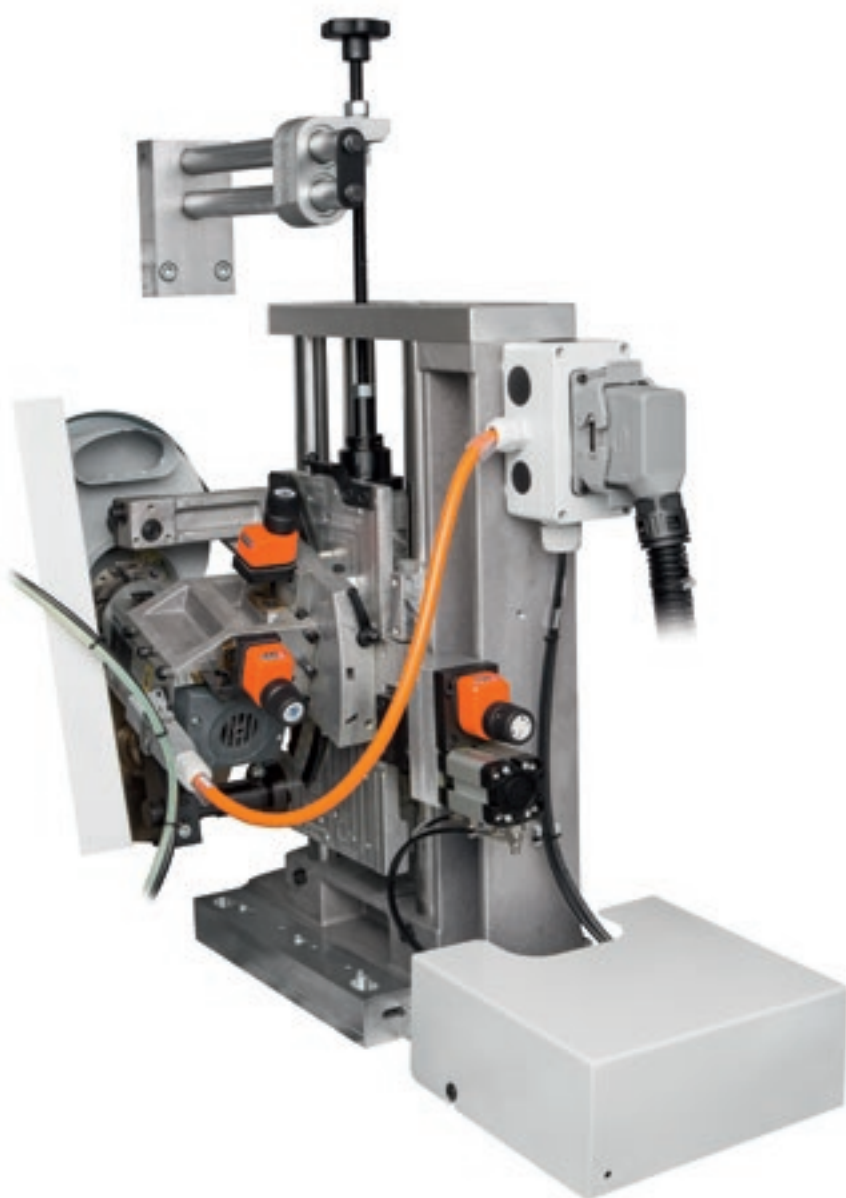

**Grooving unit** specifically designed for softforming machining operations, for processing complex profiles.

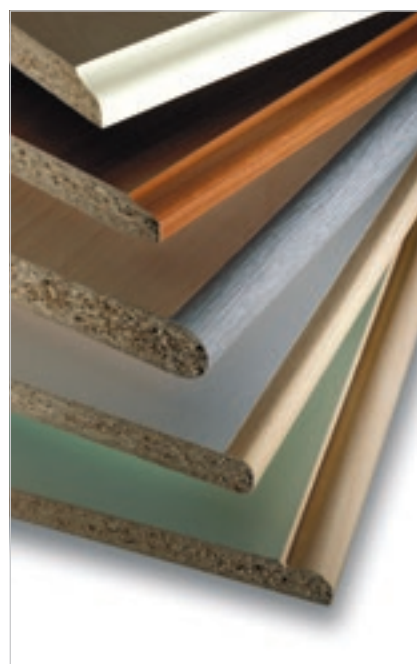

# INTEG RATED LINES

## DESIGN OF INTEGRATED LINES OVER 100 METRES LONG

BiesseSystems provides a full project consultancy and management service to companies who wish to implement integrated technology solutions for their manufacturing processes.

A team of sector experts, capable of understanding and anticipating company needs, work with the customer from inception through to system installation and commissioning.

## OVER 1000 SYSTEMS SOLD WORLDWIDE

- ✔ Design and installation of turn-key systems.
- ✔ Design and installation of automated and integrated production lines.
- ✔ Upgrading, refurbishment and integration of pre-existing production systems.

# LINE EXAMPLES

Biesse squaring and edgbanding machines are designed and built for working in fully-automated, integrated lines, for 24/7 workloads.

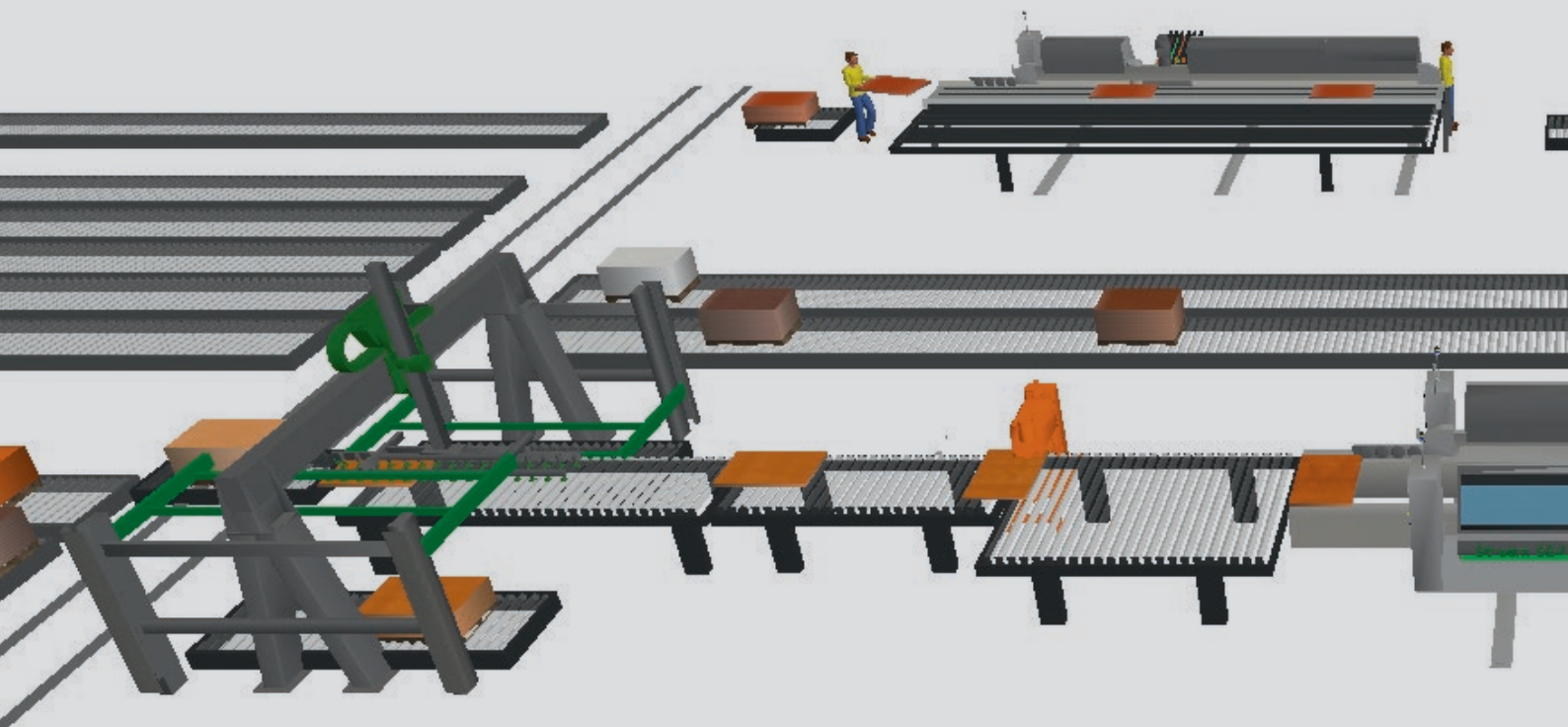
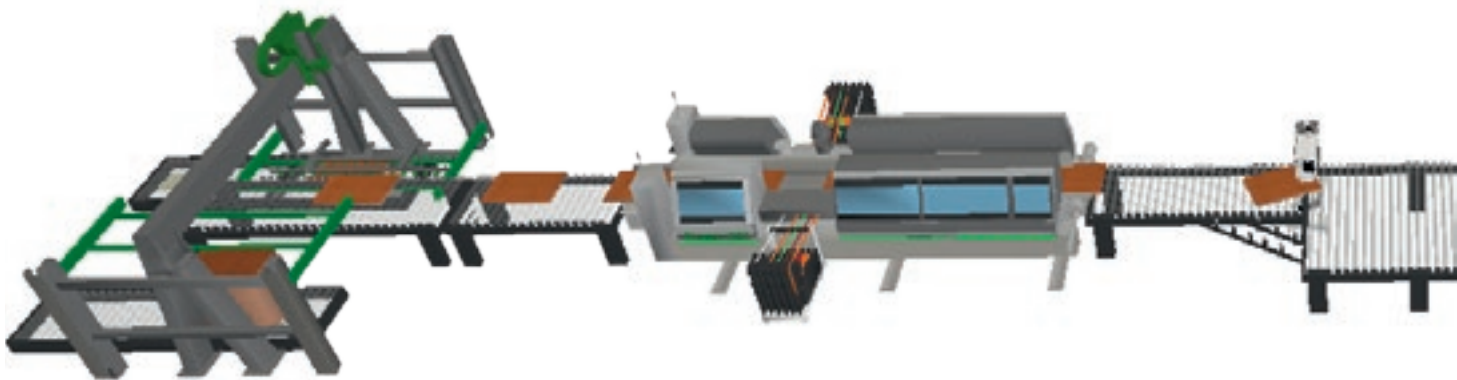

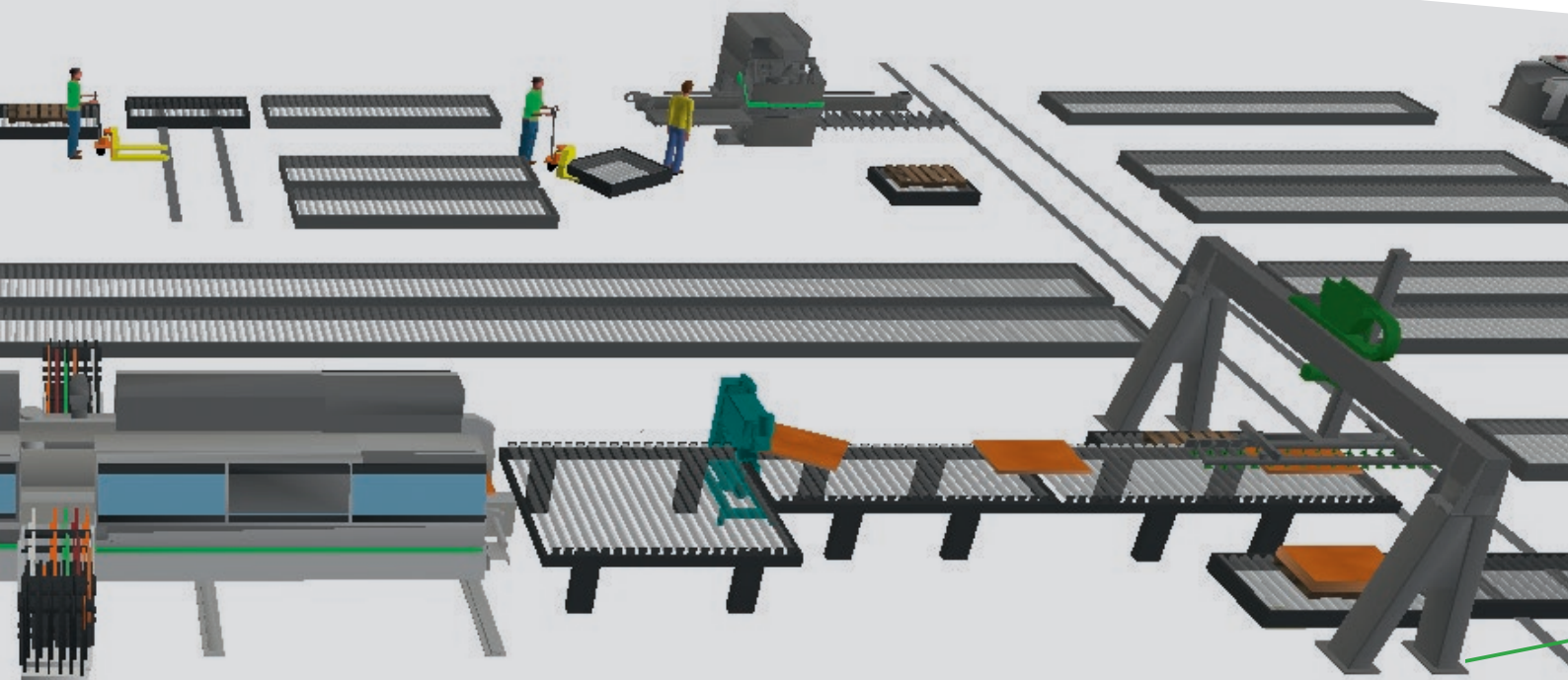

# TECHNOLOGY AT THE SERVICE OF THE USER

Instant programming within the reach of all users, thanks to the touch screen control panel.



Advanced Statistics for monitoring productivity:

- Different types of charts available to understand and improve edgeworking machine performance
- Sub-division of the production statistics on the basis of the batch or the time gap
- Mobile app for keeping in contact with the machine status at all times.

SMART TOUCH 21 control for Stream C BD2. 100% touch edgeworking machine management with no need for external devices. Maximum usability thanks to the 21.5" Full HD screen, which guarantees optimal visibility.

- Easy program management and usability.
- Rapid transition from one machining operation to the next.
- Modern, intuitive graphic interface.



# TECHNICAL DATA

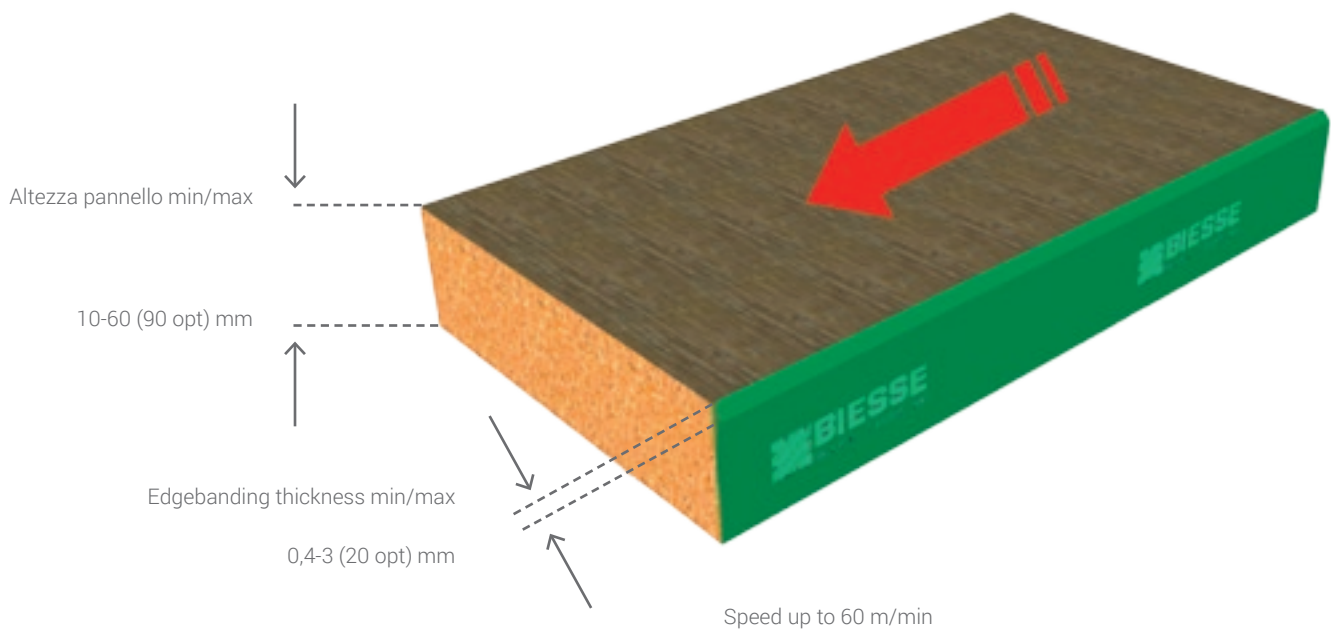

The technical specifications and drawings are non-binding. Some photos may show machines equipped with optional features. Biesse Spa reserves the right to carry out modifications without prior notice.

A-weighted sound pressure level (LpA) during machining for operator workstation on vane-pump machine LpA=86dB(A) Lwa=106dB(A) A-weighted sound-pressure level (LpA) for operator workstation and sound power level (LwA) during machining on cam-pump machine LpA=86dB(A) Lwa=106dB(A) K measurement uncertainty dB(A) 4

The measurement was carried out in compliance with UNI EN 848-3:2007, UNI EN ISO 3746: 2009 (sound power) and UNI EN ISO 11202: 2009 (sound pressure levels at workstation) during panel machining. The noise levels shown are emission levels and do not necessarily correspond to safe operation levels. Despite the fact that there is a relationship between emission and exposure levels, this may not be used in a reliable manner to establish whether further measures need to be taken. The factors determining the exposure level for the workforce include length of exposure, work environment characteristics, other sources of dust and noise, etc. i.e. the number of other adjoining machines and processes. At any rate, the above information will enable the operator to better evaluate dangers and risks.

# SOPHIA

GREATER VALUE FROM MACHINES



SOPHIA is the IoT platform created by Biesse in collaboration with Accenture which enables its customers to access a wide range of services to streamline and rationalise their work management processes.

It allows alerts and indicators to be sent to the customer in real time, in relation to production, the machines used and the type of process carried out. These are detailed instructions for more efficient use of the machine.



□ **10% CUT IN COSTS**

□ **50% REDUCTION  
IN MACHINE DOWNTIME**

□ **10% INCREASE  
IN PRODUCTIVITY**

□ **80% REDUCTION IN PROBLEM  
DIAGNOSTICS TIME**

**SOPHIA TAKES THE INTERACTION BETWEEN  
CUSTOMER AND SERVICE TO A HIGHER LEVEL.**

**iOT**  
SOPHIA

IoT - SOPHIA provides a comprehensive overview of the specific machine performance features, with remote diagnostics, machine stoppage analysis and fault prevention. The service includes a continuous connection with the control centre, the option of calling for assistance from within the customer app (such calls are managed as priorities), and an inspection visit for diagnostic and performance testing within the warranty period. Through SOPHIA, the customer receives priority technical assistance.

**PARTS**  
SOPHIA

PARTS SOPHIA is the easy new, user-friendly and personalised tool for ordering Biesse spare parts. The portal offers customers, dealers and branches the chance to navigate within a personalised account, consult the constantly updated documentation of the machines purchased, and create a spare parts purchase basket indicating the real time availability in the warehouse and the relative price list. In addition, the progress of the order can be monitored at all times.

 **BIESSE**

in collaboration with  **accenture**

# THE BIESSE RANGE FOR EDGEBANDING AND SQUARE-EDGING

## EDGE BANDING



Active Edge



Akron 1100



Jade 200



Jade 300



Akron 1300



Akron 1400

## EDGE BANDING



Stream A



Stream B

## SQUARE-EDGING



Stream C



Stream B MDS

# SERV ICE & PARTS

Direct, seamless co-ordination of service requests between Service and Parts. Support for Key Customers by dedicated Biesse personnel, either in-house and/or at the customer's site.

## BIESSE SERVICE

- ✔ Machine and system installation and commissioning.
- ✔ Training centre dedicated to Biesse Field engineers, subsidiary and dealer personnel; client training directly at client's site.
- ✔ Overhaul, upgrade, repair and maintenance.
- ✔ Remote troubleshooting and diagnostics.
- ✔ Software upgrade.

**500**

Biesse Field engineers in Italy and worldwide.

**50**

Biesse engineers manning a Teleservice Centre.

**550**

certified Dealer engineers.

**120**

training courses in a variety of languages every year.

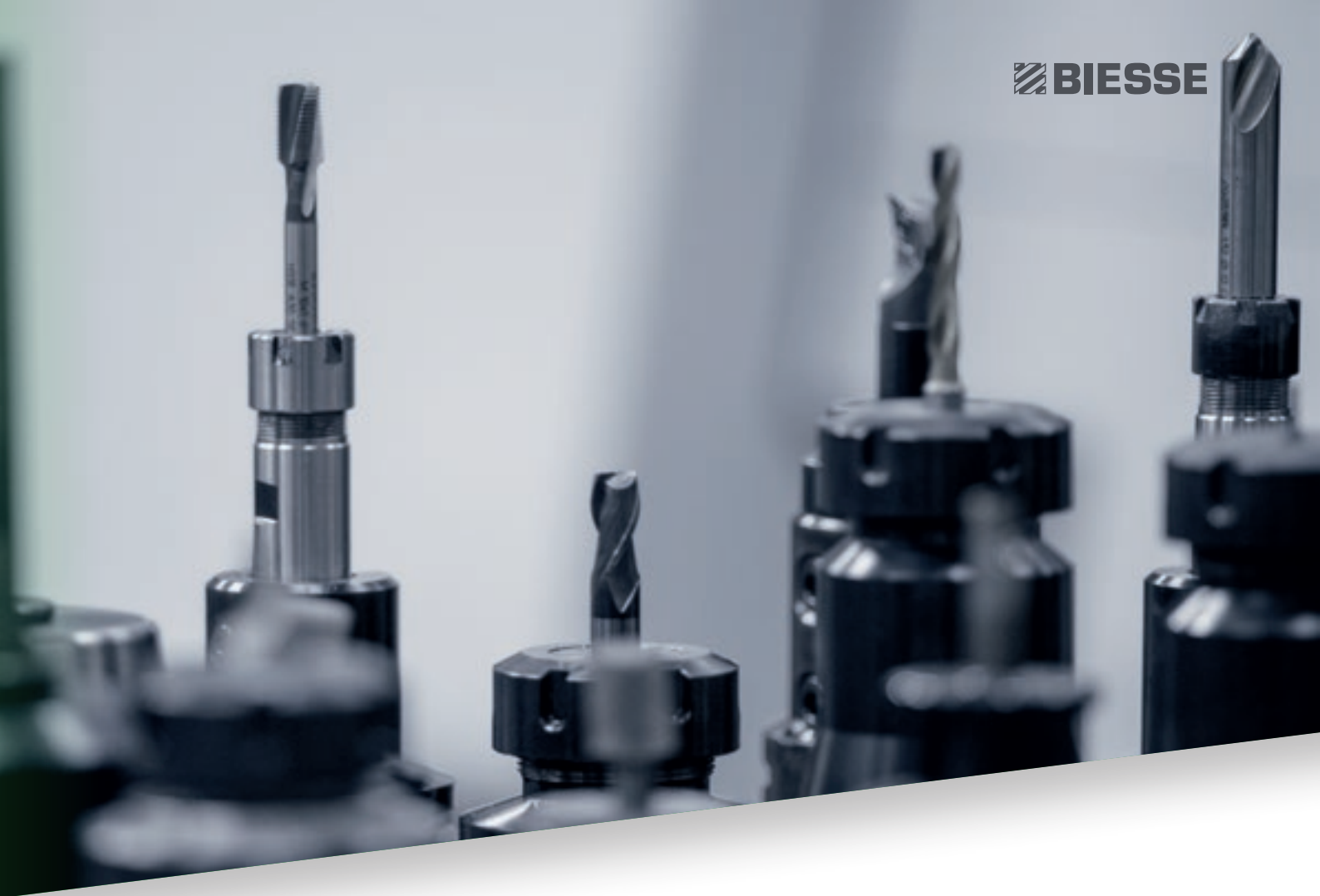
A close-up photograph of several metal drill bits and tool components, arranged in a row. The bits are of different sizes and designs, some with standard double-flute and others with more complex, multi-fluted designs. They are set against a blurred background, highlighting their metallic texture and precision engineering.

The Biesse Group promotes, nurtures and develops close and constructive relationships with customers in order to better understand their needs and improve its products and after-sales service through two dedicated areas: Biesse Service and Biesse Parts. With its global network and highly specialized team, it offers technical service and machine/component spares anywhere in the world on-site and 24/7 on-line.

## BIESSE PARTS

- ✔ Original Biesse spares and spare kits customized for different machine models.
- ✔ Spare part identification support.
- ✔ Offices of DHL, UPS and GLS logistics partners located within the Biesse spare part warehouse, with multiple daily pick-ups.
- ✔ Order fulfillment time optimized thanks to a global distribution network with de-localized, automated warehouses.

**92%**  
of downtime machine orders fulfilled within 24 hours.

**96%**  
of orders delivered in full on time.

**100**  
spare part staff in Italy and worldwide.

**500**  
orders processed every day.

# MADE WITH BIESSE

## SCA INDÚSTRIA DE MÓVEIS LTDA AND THE PARTNERSHIP WITH BIESSE

Although it operates in several different sectors, Sca Indústria de Móveis Ltda has its core business in furniture production. The company, which is well-known in Brazil, boasts a long history, beginning in 1929 when Augusto Manfroï laid the first stone of what would go on to become his furniture factory. Over time, Augusto was joined by his three sons - Sergio, Claudio and Gilmar Manfroï - who have remained by his side at every stage of his increasingly significant and challenging venture. The company combines woodworking operations with the production of cement-derived materials: sinks and tiled bathtubs, concrete and granite water tanks and much more besides. Every sink or washbasin needs a support, and as such, the synergy at the heart of the business developed naturally. Today, the main focus of Sca is on furniture: the company creates projects for the entire national market, as well as boasting excellent export figures. "Our strength is in our design", Sergio Manfroï explains. "Our mission is to develop solutions based on consumer demand. We also work with large companies, offices and in the hotel market, as well as in shipbuilding. We have around 70 sales points in Brazil and six overseas, and are deeply committed to the application of "good practices" when managing our company; this is demonstrated by the ISO9000 and ISO14000 certification that we have achieved for dedication to the environment, in addition to the OHSAS ISO18000 certification for the safety of our employees.

This journey has provided us with a great degree of satisfaction, and requires us to use materials with certified origins only: we use raw materials, semi-finished products and high-quality components, which our highly-qualified design team help to transform into finished pieces, while our efficient working group are engaged in researching and developing new products. Technology is an increasingly element important in our work, and as such, we chose to work with Biesse some time ago. The company remains our most important partner today," Manfroï tells us. "Like us, and like all of our suppliers, Biesse remains committed to continuous research and is focused on ongoing improvement, perfecting machining operations in order to improve production and further enhance machine efficiency. And like us, Biesse strives to grow and develop, offering the best possible solutions to the market and supporting a process of continuous improvement. Today, the company is undoubtedly the best technical partner we have, and we have enormous faith in Biesse, and in the work, professionalism and experience of the organisation. This is supported by the contribution of the team that represents the brand in our country, the Gati Group, with whom we collaborate on a daily basis. The characteristic that has been most decisive in winning our loyalty is the reliability Biesse provides: here, we are referring what we do, and the service that we provide to our customers, two values which are fundamental to us,

and which we always look for in those who work with us and for us. Service, reliability, efficiency and effectiveness are our watchwords, but we also want everyone involved with us on any level to share these, so that we can ensure that all our requirements regarding assistance and support are met in full, as well as in terms of continuous improvement of the product. We operate in an industry that must deliver efficient service, and Biesse is a great partner in this regard." "We invest consistently in technology: a few years ago, for example, we purchased a system from Biesse which improves the flexibility of our production on the market. A Stream Mds is the latest Biesse product that we have invested in - an edgbanding machine that resolved a host of problems relating to flexible square-edging, and which can be used to produce panels that are ready to move to the assembly phase with no additional equipment. And that's just the latest investment! We remain in constant contact with Biesse, as I already mentioned, working together to determine how we can perfect our processes, reduce our consumption of energy and materials, and improve our products. We don't simply want a company to buy a machine from - for us, the ability to interface with a trusted supplier to discuss and evaluate the best decisions and subsequent steps is crucial."

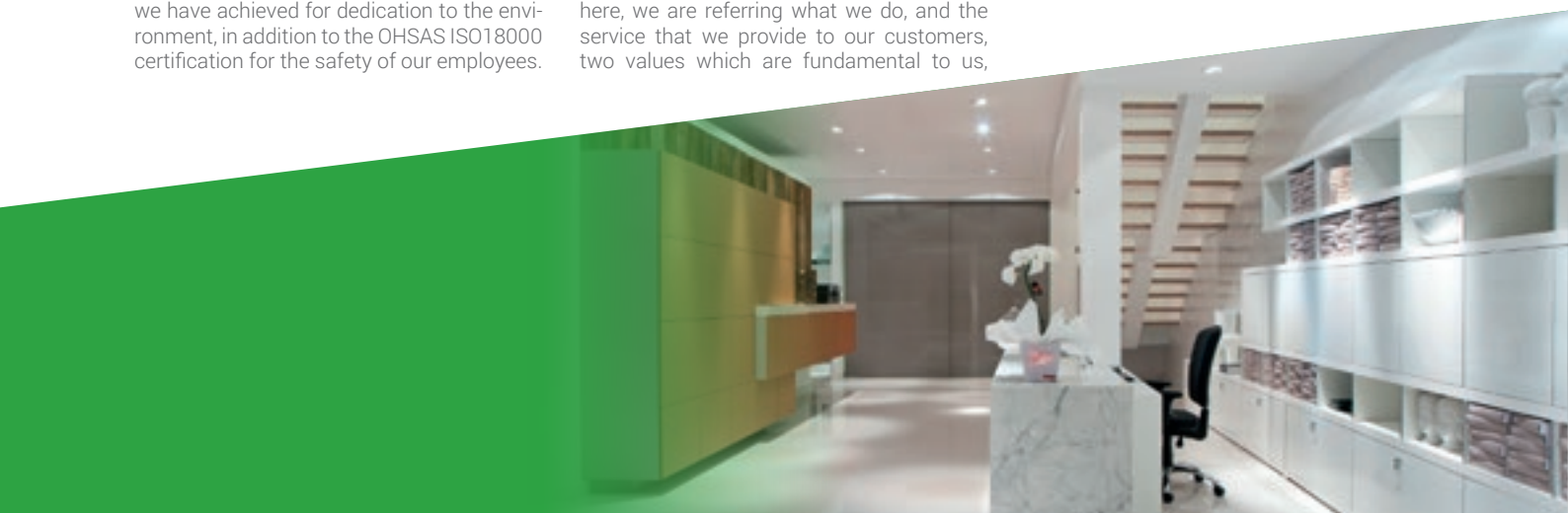

# LIVE THE EXPERIENCE



Interconnected technologies and advanced services that maximise efficiency and productivity, generating new skills to serve better our customer.

**LIVE THE BIESSE GROUP EXPERIENCE AT OUR CAMPUSES ACROSS THE WORLD.**

