

Edge banding machines Optimat KDN 330 - KDN 350 C



One series for all materials

Customised further development

More than 3000 satisfied customers worldwide use one of our former KD 50-series machines on a daily basis, in some cases under the harshest possible conditions.

The new types of the proven series offer an impressive number of additional detail improvements to further enhance customer benefit. The new attractive machine design with its once again improved ergonomic features additionally increases this new series' attractive lines.

Safe and reliable gluing

The KDN 300 machines are equipped with easy to operate, leak-proof glue application systems that allow optimally dosed glue joints. Commercially available hotmelt pellets are used.





KDN 350 C



KDN 350 C

High performance processing units ensure flexible production

All processing units share high precision, forming the basis for optimum processing quality. Fast resetting, easy to maintain design and the high reliability standard are further features.

1. Gluing unit

All machines of the series KDN 300 are equipped with the leak-proof fast heat-up basin. Precise dosing allows optimum glue joints. The standard contact heating shoe guarantees an optimum gluing quality even under unfavourable conditions, e.g. non-heated workshop or workpiece temperature below the ambient temperature.

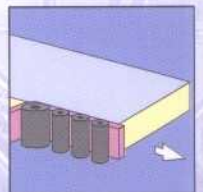
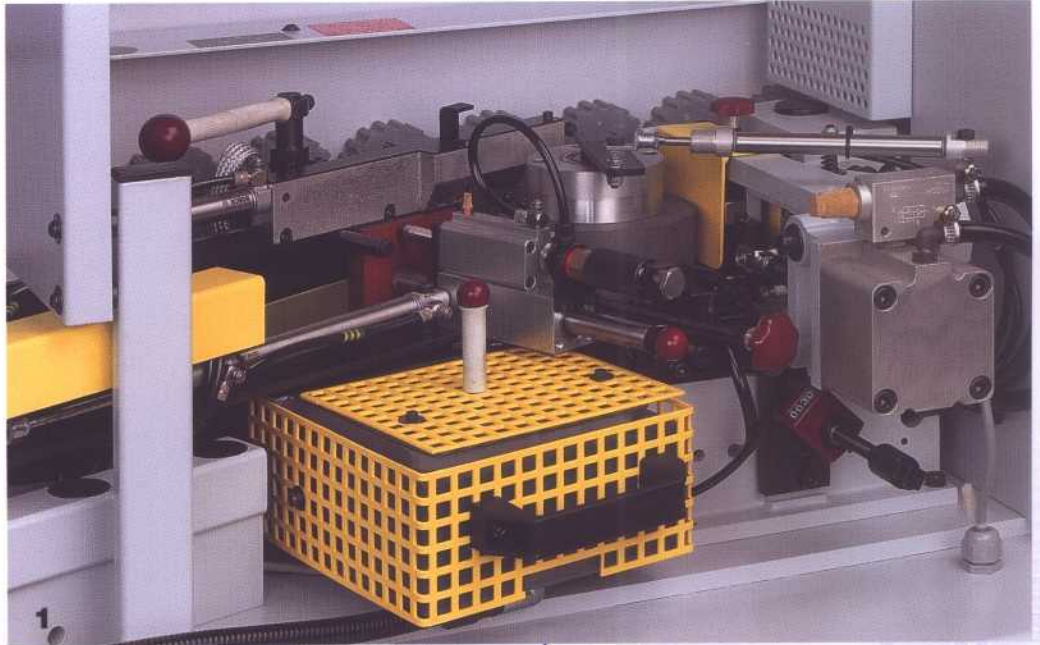

Machine controls

The models of the KDN 300 series are equipped with the high performance easy to operate electronic control system. The entire control panel is located within easy reach of the machine operator.

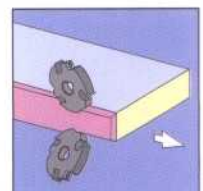
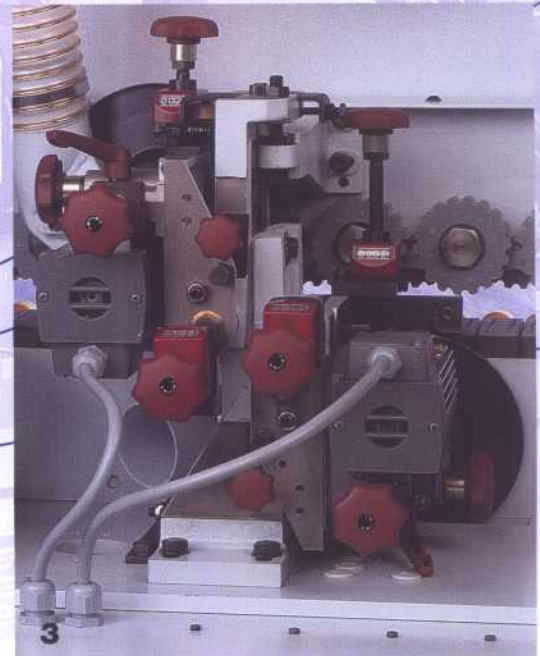
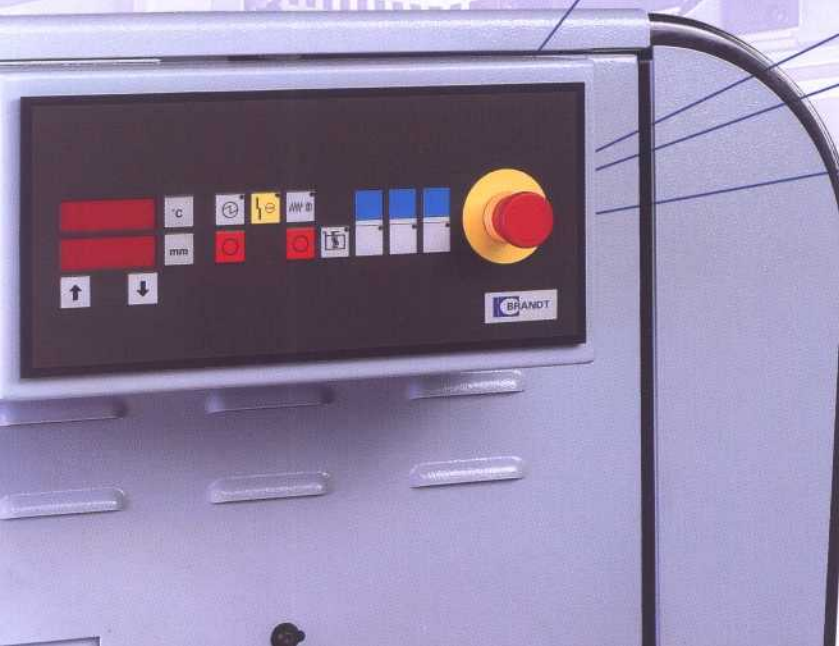

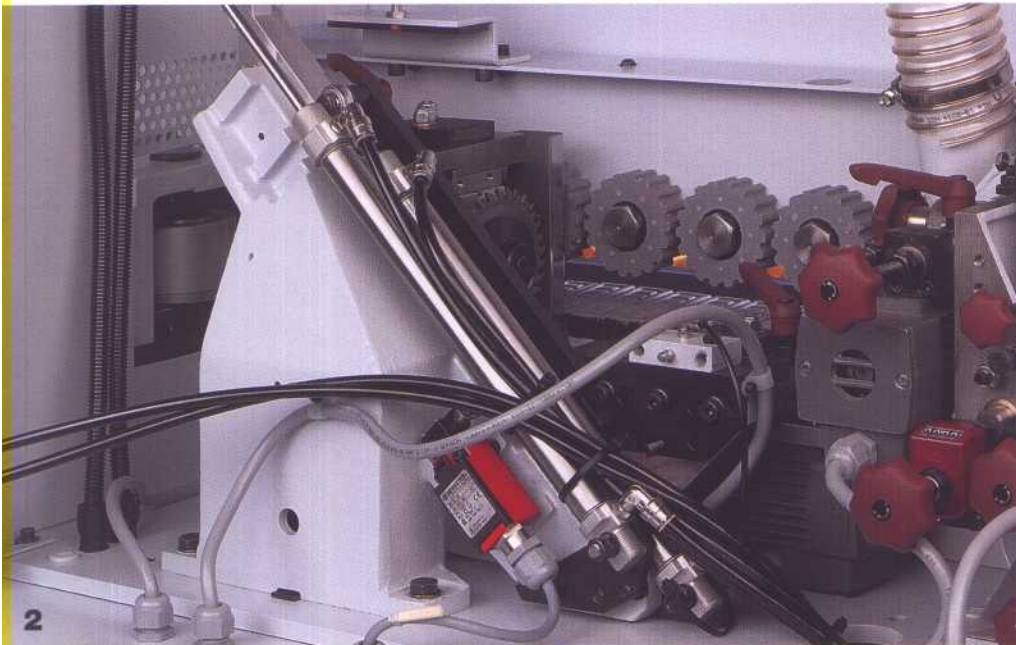

2. Trimming unit

Two trimming motors, each 0.18 kW, 12,000 rpm. High accuracy is guaranteed by the principle of the pulling cut. High precision linear guides comparable to those installed in complex CNC controlled machines are a further guarantee for perfect processing results.

3. Flush trimming unit

Equipped with two milling motors, each 0.27 kW, 12,000 rpm. Standard equipment including reversible tip combination milling tools for radius/straight edge permit fast and defined, i.e. repeatable settings.

4. Scraper unit

To finish pre-milled PVC edging using profiled cutters. Horizontal/vertical tracing.

5. Buffing unit

2 motors, equipped with molleton wheels, individually fitted and adjustable – for a perfect finish of the edge.

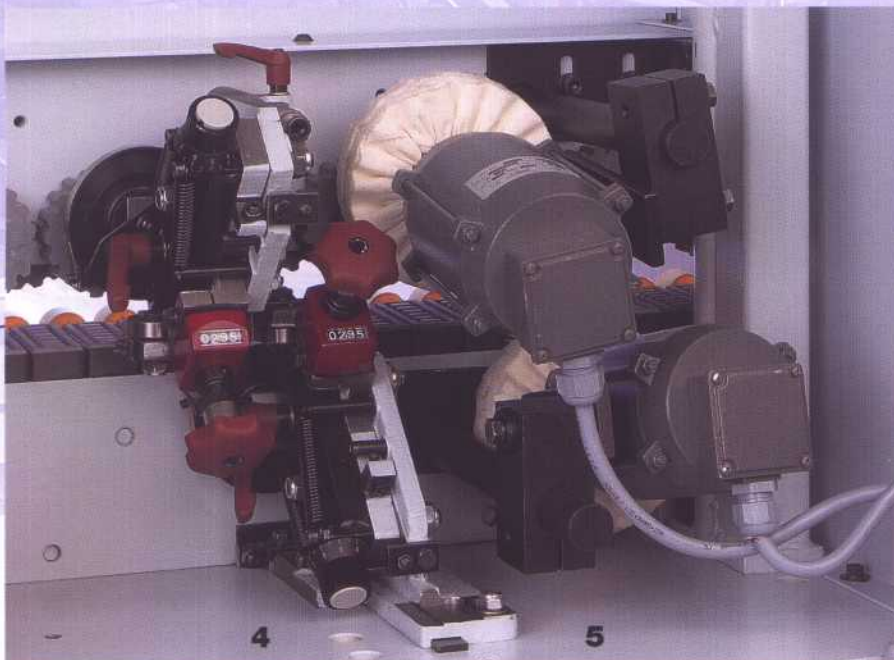
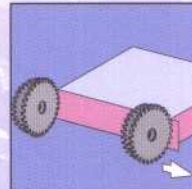

...the following features stand for the uniqueness of the Optimat KDN 330 - 340 series:

- Electronic, easy to operate machine controls
- Central lubrication of the chain track
- Precise dosing, leak-proof direct glue application
- Central top pressure and unit height adjustment
- HighTech linear guide of the trimming unit for maximum precision
- Electronic temperature control with timed, automatic lowering
- Electronic frequency changer, incl. safety motor brake for trimming and flush trimming motors
- Integrated line control for the capacitive control of processing functions
- Contact heating shoe for workpiece pre-heating with critical materials and low external temperatures
- ... and extremely short make-ready times

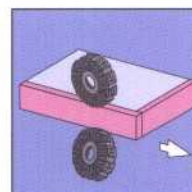
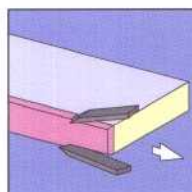

Machine control system, processing units KDN 350 C

High performance processing units ensure flexible production

All processing units share high precision, forming the basis for optimum processing quality. Fast resetting, easy to maintain design and the high reliability standard are further features.

1. Gluing unit

All machines of the series KDN 300 are equipped with the leak-proof fast heat-up basin. Precise dosing allows optimum glue joints.

The standard contact heating shoe guarantees an optimum gluing quality even under unfavourable conditions, e.g. non-heated workshop or workpiece temperature below the ambient temperature.



Machine controls

The models of the KDN 350 C series are equipped with the high performance PC 16 machine control system based on an industrial PC, the same that is used on high performance industrial machines.

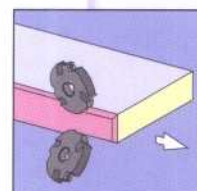
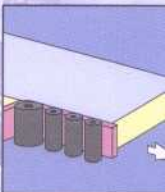
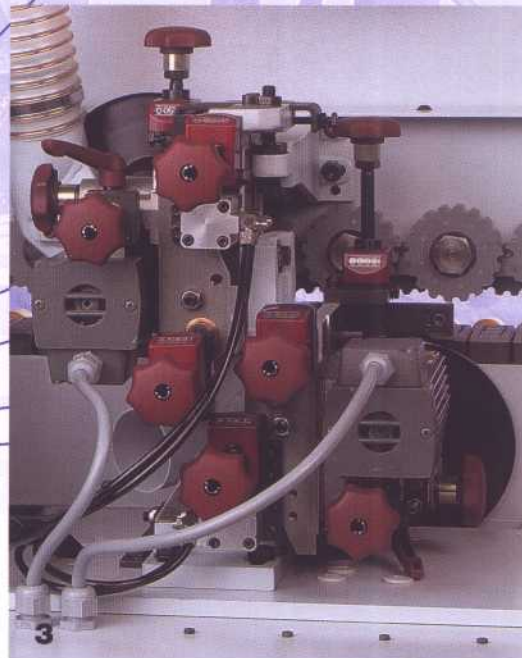

2. Trimming unit

Two trimming motors, each 0.18 kW, 12,000 rpm.

High accuracy is guaranteed by the principle of the pulling cut. High precision linear guides comparable to those installed in complex CNC controlled machines are a further guarantee for perfect processing results. Pneumatic adjustment for chamfer/straight edges.

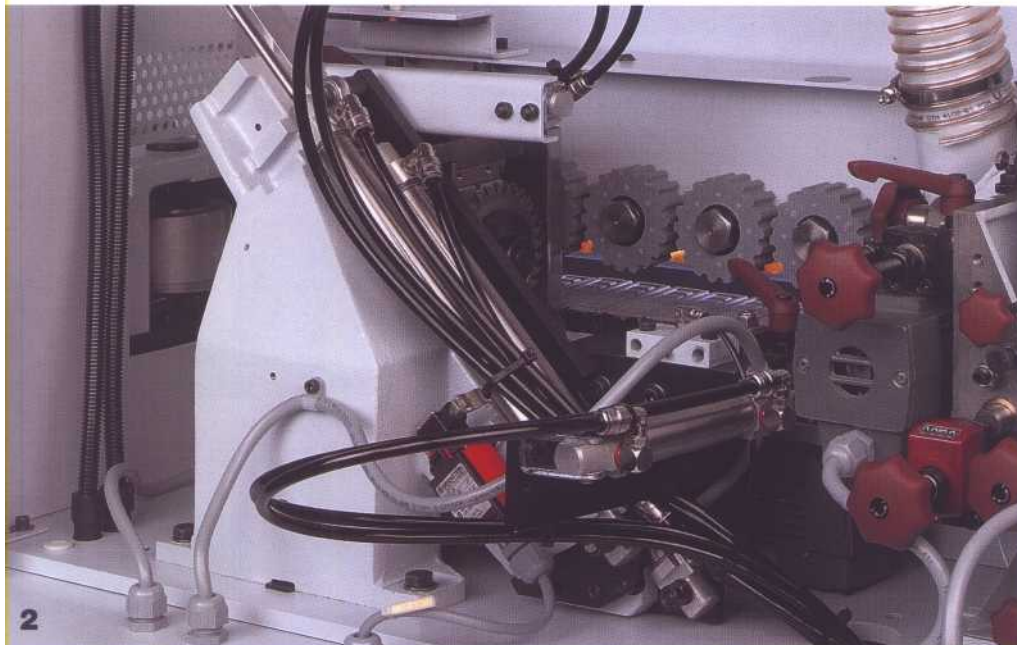

3. Flush trimming unit

Equipped with two milling motors, each 0.27 kW, 12,000 rpm.

Standard equipment including reversible tip combination milling tools for radius/straight edges permit fast and defined, i.e. repeatable settings. Two-point pneumatic adjustment of the top and bottom milling motor.

4. Contour trimming unit

top + bottom, for rounding corners of thick PVC edges 1 motor 0,35 kW, 12.000 rpm.

Standard equipment with radius cutter tools $r = 3$ mm.

5. Scraper unit

To finish pre-milled PVC edging using profiled cutters. Horizontal/vertical tracing. The model KDN 350 C is equipped with a pneumatically controlled engagement of the scraper unit.

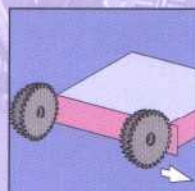

6. Buffing unit

2 motors, equipped with molleton wheels, individually fitted and adjustable – for a perfect finish of the edge.

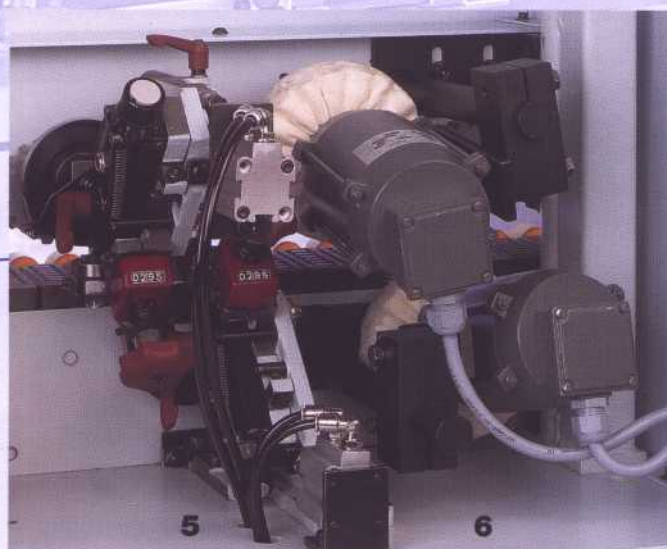
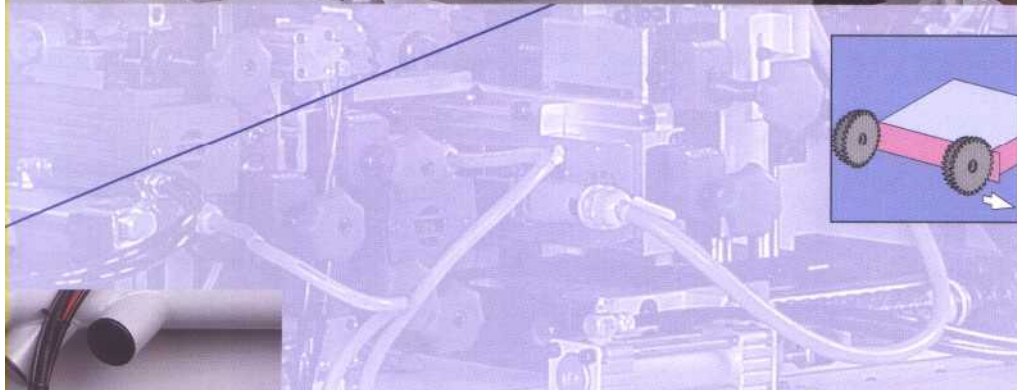

...the following features stand for the uniqueness of the Optimat KDN 350 C:

- High capacity PC 16 machine controls on the basis of an industrial PC
- Central lubrication of the chain track
- Precise dosing, leak-proof direct glue application
- Central top pressure and unit height adjustment
- HighTech linear guide of the trimming unit for maximum precision
- Electronic temperature control with timed, automatic lowering
- Electronic frequency changer, incl. safety motor brake for trimming and flush trimming motors
- Integrated line control for the capacitive control of processing functions
- Contact heating shoe for workpiece pre-heating with critical materials and low external temperatures
- ... and extremely short make-ready times

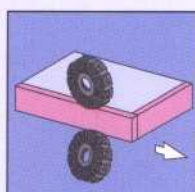
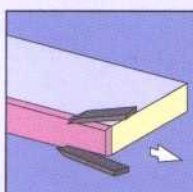
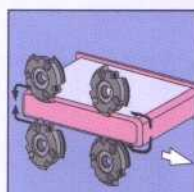

Technische Daten

KDN 330

This machine was integrated in the type range for companies with limited space and a smaller budget. It goes without saying that also this model incorporates all basic features and advantages which the larger machines offer.

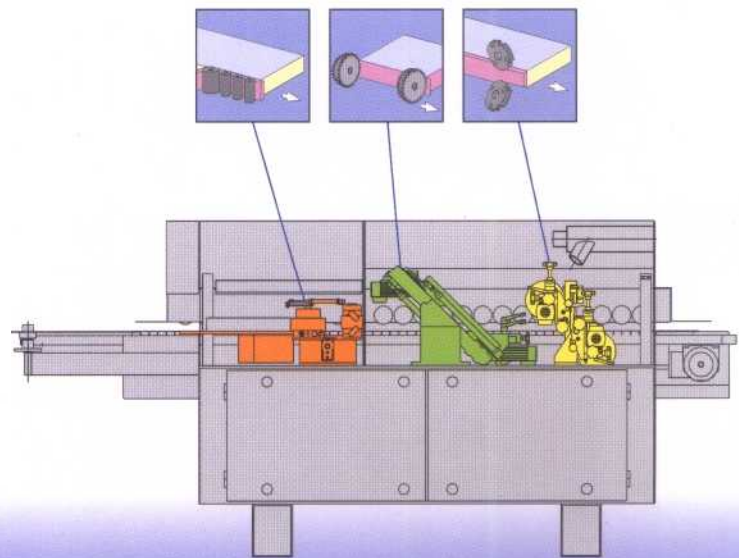

Optimat
KDN 330

KDN 335

This machine is equipped identical to the smaller KDN 330, however, it has an additional buffing unit. This unit improves the edge finish following flush milling. To achieve an optimum finish, the best suited tools (buffing wheels) can be fitted for the different edge banding materials.

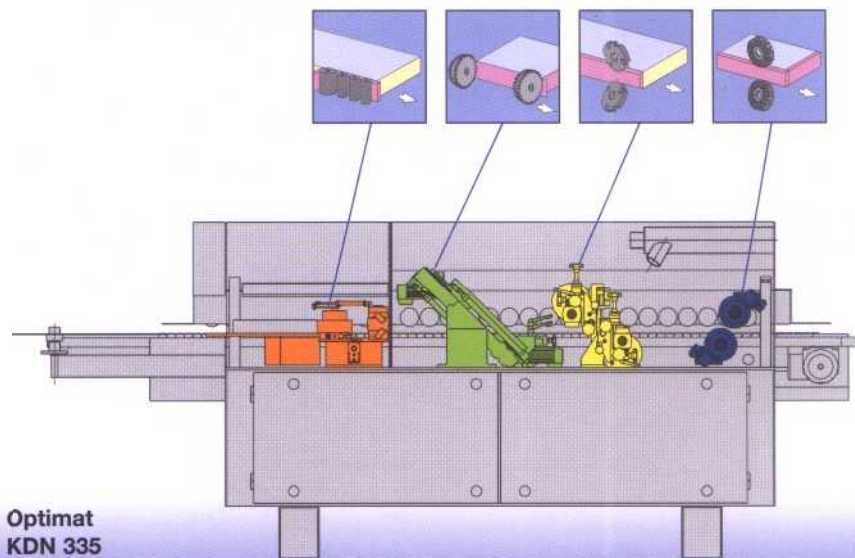

Optimat
KDN 335

KDN 340

In its new design, the KDN 340 will even increase its popularity as the best selling edge banding machine. In addition to the excellent value for money, its technical features and the improved ergonomics including a clearer arrangement in the unit zone due to the new machine.

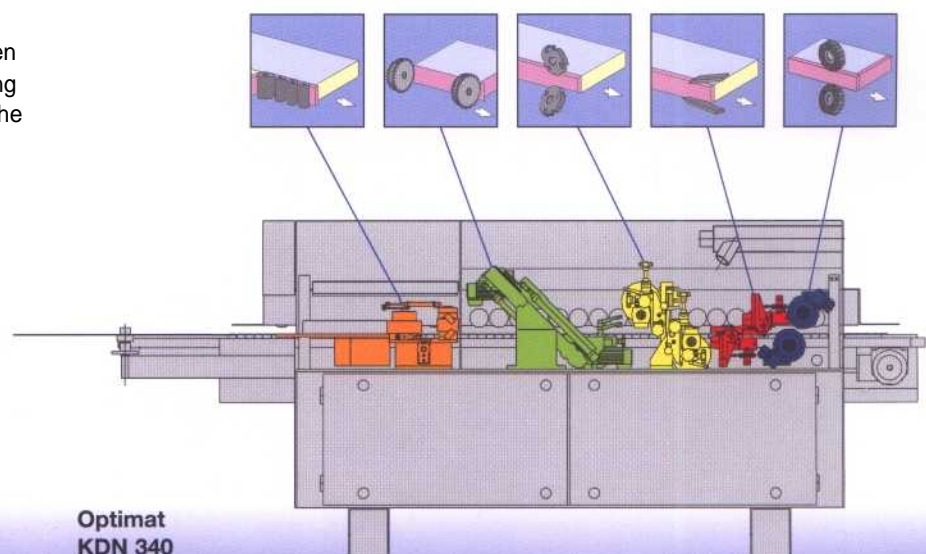

Optimat
KDN 340

KDN 350 C

Complete processing as on large industrial machines is permitted by the automatic profile cutter/corner rounding unit. With its comfortable overall equipment, the KDN 350 C is the largest among the small edge banders.

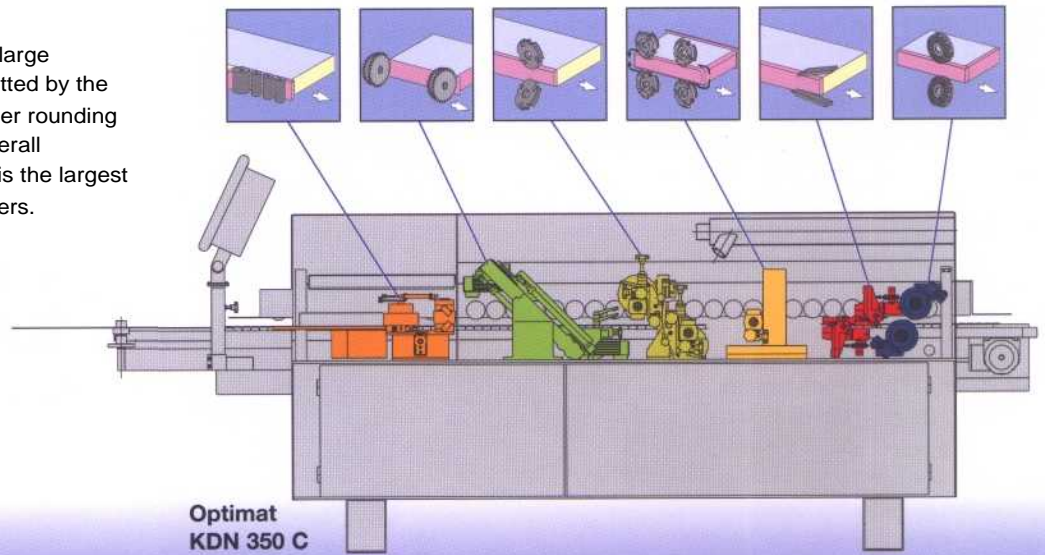

	KDN 330	KDN 335	KDN 340	KDN 350C
Workpiece thickness (mm)		8 - 40		
Edge thickness (mm)		0,4- 3 (max 3 x 30 / 0,8 x 45)		
Fixed length max.		max. 3 x 45		
Feed speed (m/min) approx.		9		
Electrical installation		400 V - 3 Ph. - 50 Hz.		
Connected value (kW)	4,0	5,0	5,0	5,5
Compressed air connection (bar)		6		
Weight (kg) approx.	750	850	900	1050
Machine length (mm) approx.	3150	3450	3450	3800

All rights for technical changes withheld. Individual machines shown could include options.



Contact heating shoe

As standard, all machines of the KDN 300 series are equipped with a contact heating shoe that - optionally activated - transfers contact heat into the board edge directly prior to the glue application to the workpiece edge, this notably optimising the gluing quality, especially with difficult edging materials or at very low ambient temperatures.

HighTech machine components

The proverbial Brandt quality is documented by the use of top of the line components. The illustrated linear guide element which in the same design is also used in highly dynamic CNC machines, is just one example for this.

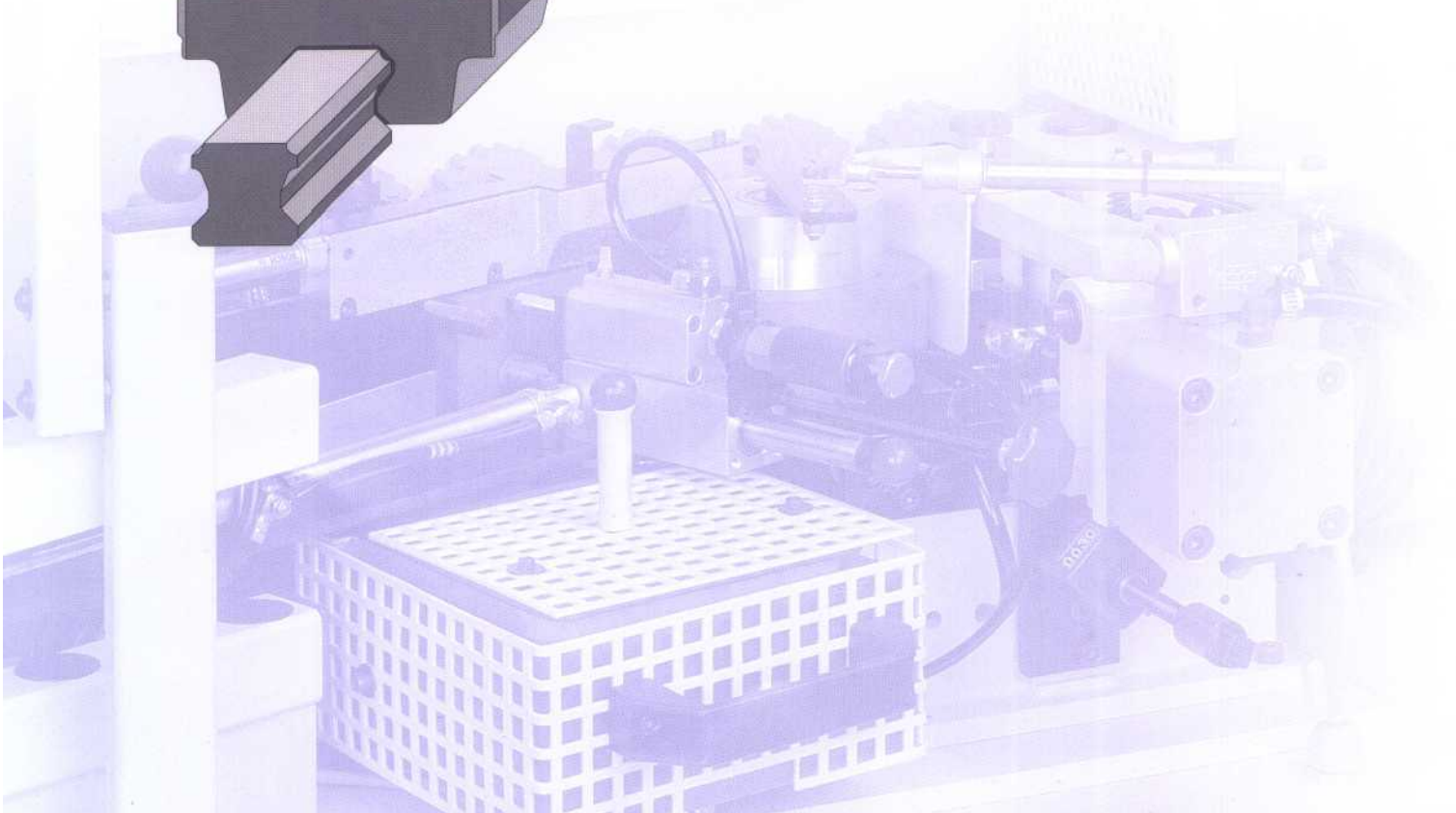
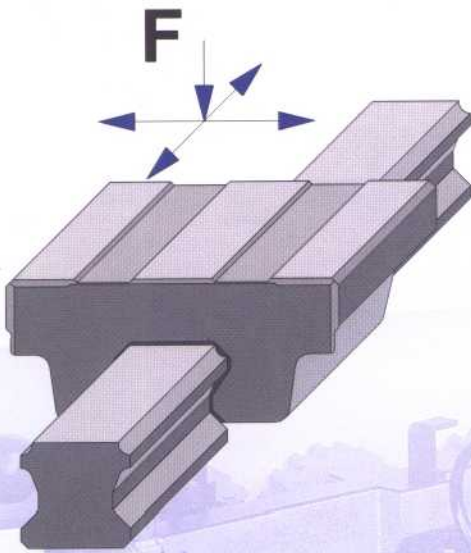
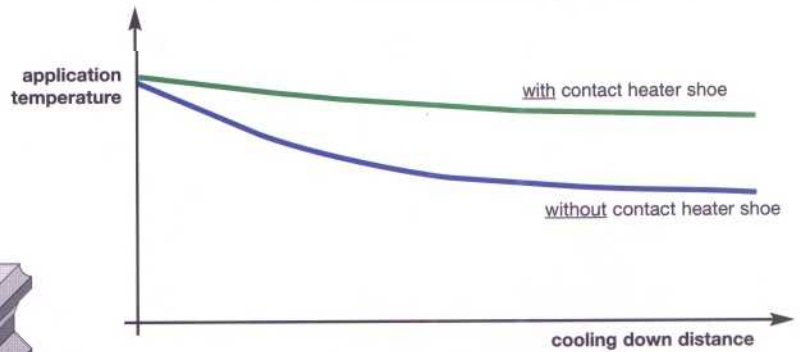
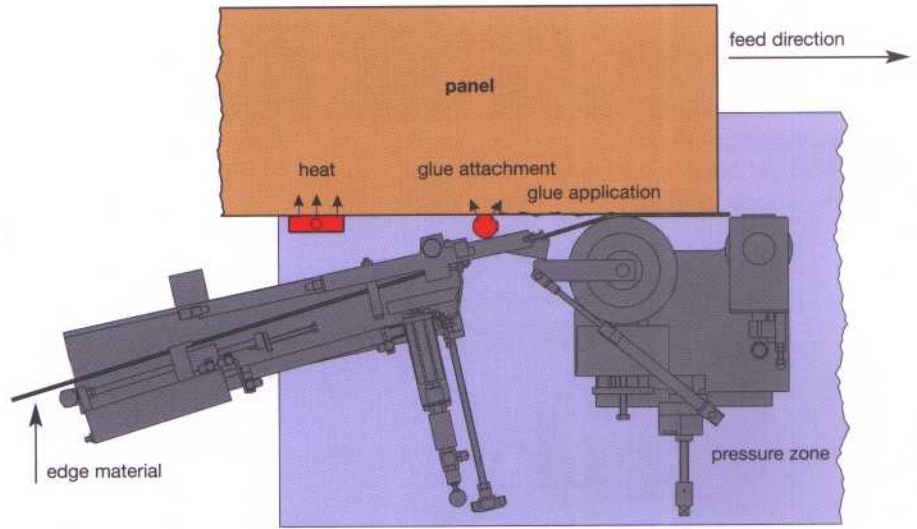

It pays to be a Brandt customer



Brandt is present everywhere

The well established service, marketing and agencies network means short distances for you and the closest possible vicinity to the customer - world wide.

High degree of competence

Constant training of the sales and service personnel of our marketing partners in the Brandt training centre guarantees optimal service competence.

Same parts, simple handling

Many parts, control elements and subassemblies are identical for Homag Group machines and equipment. This makes operating them easier, simplifies the stock-keeping of spare parts and speeds up maintenance and service.





A member of the Homag Group of Companies



Brandt
Kantentechnik GmbH
Weststraße 2
D-32657 Lemgo
Tel. 05261/974-0
Fax 05261/6486
info@brandt.de
<http://www.brandt.de>

