

# EDGETEQ

## S-380 /

## S-380 profiLine

**Fast feed, many units, large screen.**

Perfect for reliable edge gluing.





# Perfect edges produced with flexible machines for demanding customers

Individual customer requirements, sophisticated products and a wide range of materials — these are all requirements that play a key role in today's wood processing sector. It is therefore important that production is flexible and efficient, especially in woodworking shops and for medium-sized businesses.

HOMAG offers you unbeatable advantages, has an international production network as well as sales and service companies, with a presence in more than 100 countries and around 7000 employees. HOMAG can help make your business competitive and ensure lasting business success.

## YOUR SOLUTION

[MORE AT HOMAG.COM](https://www.homag.com)



## CONTENTS

- 04 The most important features
- 08 EDGETEQ S-380 | S-380 profiLine series
- 16 Our unit modules
- 33 LOOPTEQ return
- 34 Apps and digital assistants
- 36 EDGETEQ S-380 profiLine
- 38 Control with powerTouch
- 40 Technical data
- 42 Life Cycle Services



# You can choose between eight models and the freely configurable profiLine

## THE MOST IMPORTANT FEATURES

What distinguishes the series is the extensive equipment, including a belt top roll pressure unit for precise workpiece guidance, as well as optimized trimming tools for optimum chip removal and perfect processing quality. A variable feed rate for different performance classes ensures a high level of productivity. In addition, all machines can be extended.

**THE EDGETEQ S-380 PROFILINE** offers additional units in comparison to the preconfigured models and can also be freely equipped from the extensive unit modules.

Machines in the EDGETEQ S-380 series are energy efficient and environmentally friendly.

- **High-quality furniture with high-quality edges**
- **More output due to high availability**
- **Low energy requirements**
- **High levels of efficiency**
- **Optimum price/performance ratio**

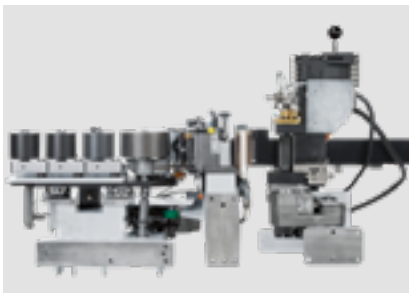

### Gluing units for safe hot-melt glue application

HOMAG gluing units are ideal for fast, solid gluing of EVA and PUR. The heated gluing roller ensures an optimal adhesive temperature.



### Edge gluing with PUR

At HOMAG, PUR glues are processed on the same machines and with the same application unit as EVA hot-melt glues.

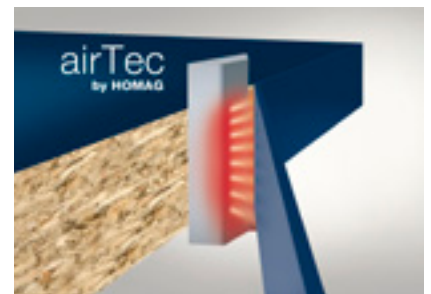

### Zero joint technology with HOMAG airTec

The units are now equipped with a rotary fan heater, which improves the efficiency of the process, reduces noise and ensures a more cost-effective use of resources.



**Intuitive operation with the powerTouch control system**

Control machine functions directly using the multi-touch monitor in widescreen format. The ergonomic design and numerous help and assistant functions simplify operation significantly.



**Belt top roll pressure unit**

The steel top roll pressure unit with double V-belt provides the basis for the highest quality because your workpieces are optimally clamped for processing.



**Multi-profile technology**

For easy adjustment of the units at the touch of a button. Saves time and increases quality.

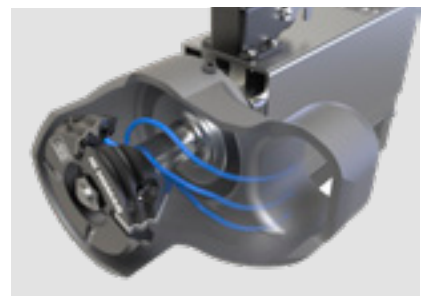

**Controlled chip collection**

The chips are suctioned up in the interior and fed to the extraction hood in a targeted manner. Reduced wear and tear and lower service costs increase profitability and service life. The reduced suction speed lowers energy consumption and costs.

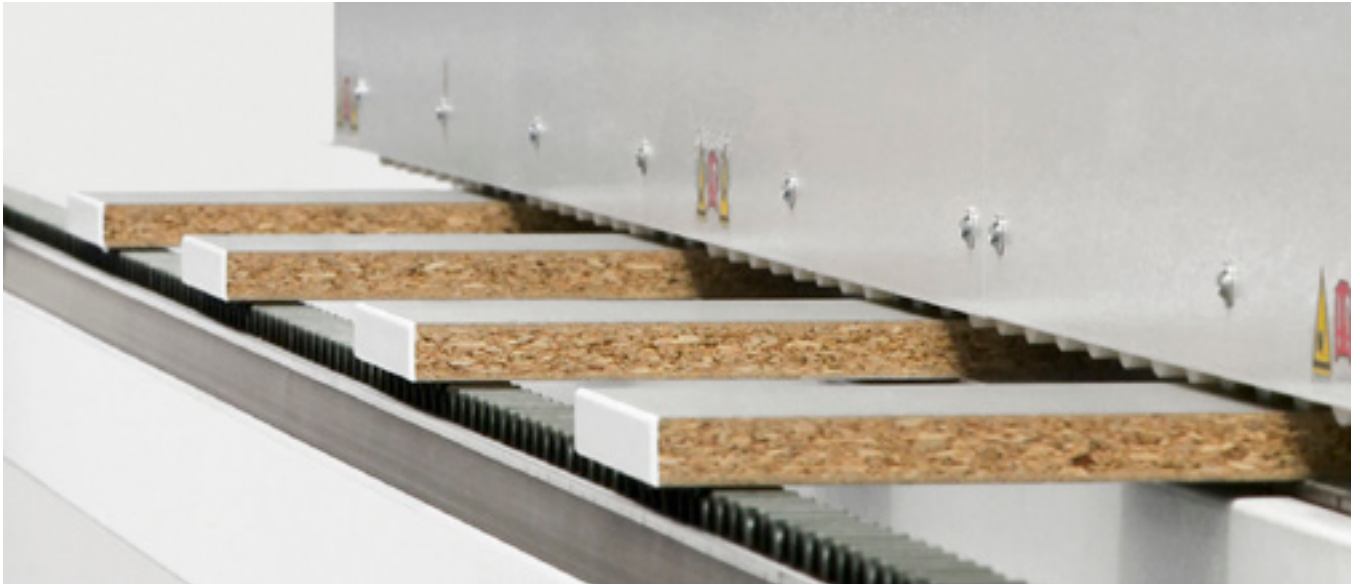

## Material types | Edge parameters

A high level of flexibility is achieved through the processing of all types of edge materials: 0.3-mm melamine, 3-mm ABS/PVC, 20-mm solid strip and veneer. For perfect high-gloss parts, important components such as the motorized top roll pressure unit and the automatic adjustment of the glue joint scrapers are used. Special tracing elements are ideal for processing sharp-angled or blunt-angled parts or parts with hinge holes.



				a	b	c	d	e
	<b>SOLID</b> (mm)					0.4–12.0 (Optional 0.4–20.0)		
	<b>ROLLERS</b> (mm)		If $b \leq 22$ : min. 60 If $b \leq 40$ : min. 125	8–60	0.3–3.0	65	Max. 30	
	<b>STRIPS</b> (mm)				0.4–3.0 Optional			



## Increased productivity for your edge banding machine

Workpiece returns of the LOOPTEQ series are an optimal supplement to the machines of the EDGETEQ series. The LOOPTEQ O-200 is ideal for small, narrow and medium-sized workpieces. The LOOPTEQ O-300 is ideal if you have a wide range of parts, from small and light to large and heavy workpieces.





## EDGETEQ S-380

Models 1650 FC | 1670 FGC:

### Setting standards for performance and quality

The basic machine is equipped with a precise gluing station, a dual-motor snipping unit, a trimmer and a profile trimming unit. A radius scraper, a glue joint scraper and a buffing unit provide the perfect finish. The powerful motors of all units provide the unrestricted power required for processing the wide range of parts. In order to always be in a position to offer

the optimum solution, a joint trimming unit and a swiveling grooving unit (1670 FGC) are available for the machines. Thanks to the optional Quickmelt gluing station, the optional workpiece gap optimization for even more effective production and the available separating and cleaning agents, this series is optimally equipped for all requirements.





## EDGETEQ S-380

Model 1650 FC

Feed speed: 8–18 m/min (optional: 20)

- 1 Joint trimming unit
- 2 Gluing unit
- 3 Snipping unit
- 4 Trimming unit with pneumatic two-point adjustment
- 5 Profile trimming unit
- 6 Profile scraper with quick-change heads
- 7 Glue joint scraper
- 8 Buffing unit

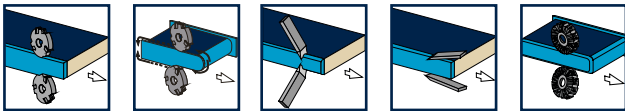

### EDGETEQ S-380 — 1660 FGC model

This model contains the same equipment as the 1650 FC model, with the addition of a grooving unit and a safety pressure device.



## EDGETEQ S-380 — 1650 HF and 1660 HF models: Precision and performance for high demands

The basic machine is equipped with a Quickmelt gluing station, a dual-motor snipping unit, a trimmer and a multifunction profile trimming unit for corner rounding and flush trimming. A radius scraper and a buffing unit provide the perfect finish. The powerful motors of all units provide the unrestricted power required for processing the wide range of parts. In order to always be in a position to offer the

optimum solution, a joint trimming unit and a glue joint scraper are available as standard for these machines. The Highflex series is distinguished by its high level of automation and the extensive unit equipment. The high level of flexibility allows the machines to be aligned to your needs and guarantees optimal edges.

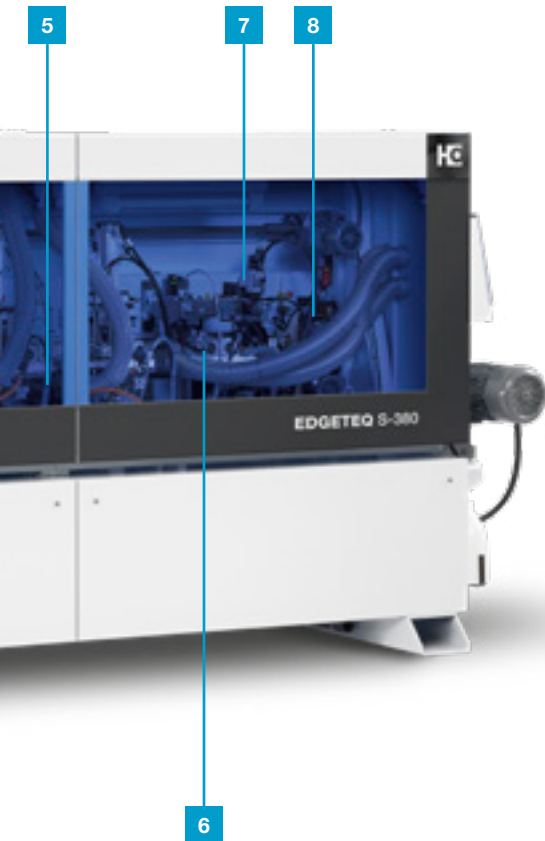

## EDGETEQ S-380

Model 1650 HF

Feed speed: 8–18 m/min

- 1** Joint trimming unit
- 2** Gluing unit
- 3** Snipping unit with pneumatic adjustment for chamfers/straight lines and pneumatic two-point adjustment
- 4** Pre-trimming unit with pneumatic two-point adjustment
- 5** Multifunction profile trimming unit
- 6** Profile scraper with quick-change heads and pneumatic adjustment
- 7** Glue joint scraper
- 8** Buffing unit

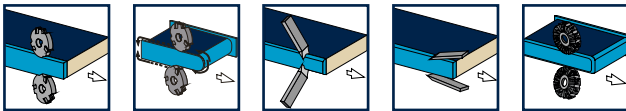

### EDGETEQ S-380 — 1660 HF model

This model contains the same equipment as the 1650 HF model, with the addition of a fine trimming unit.

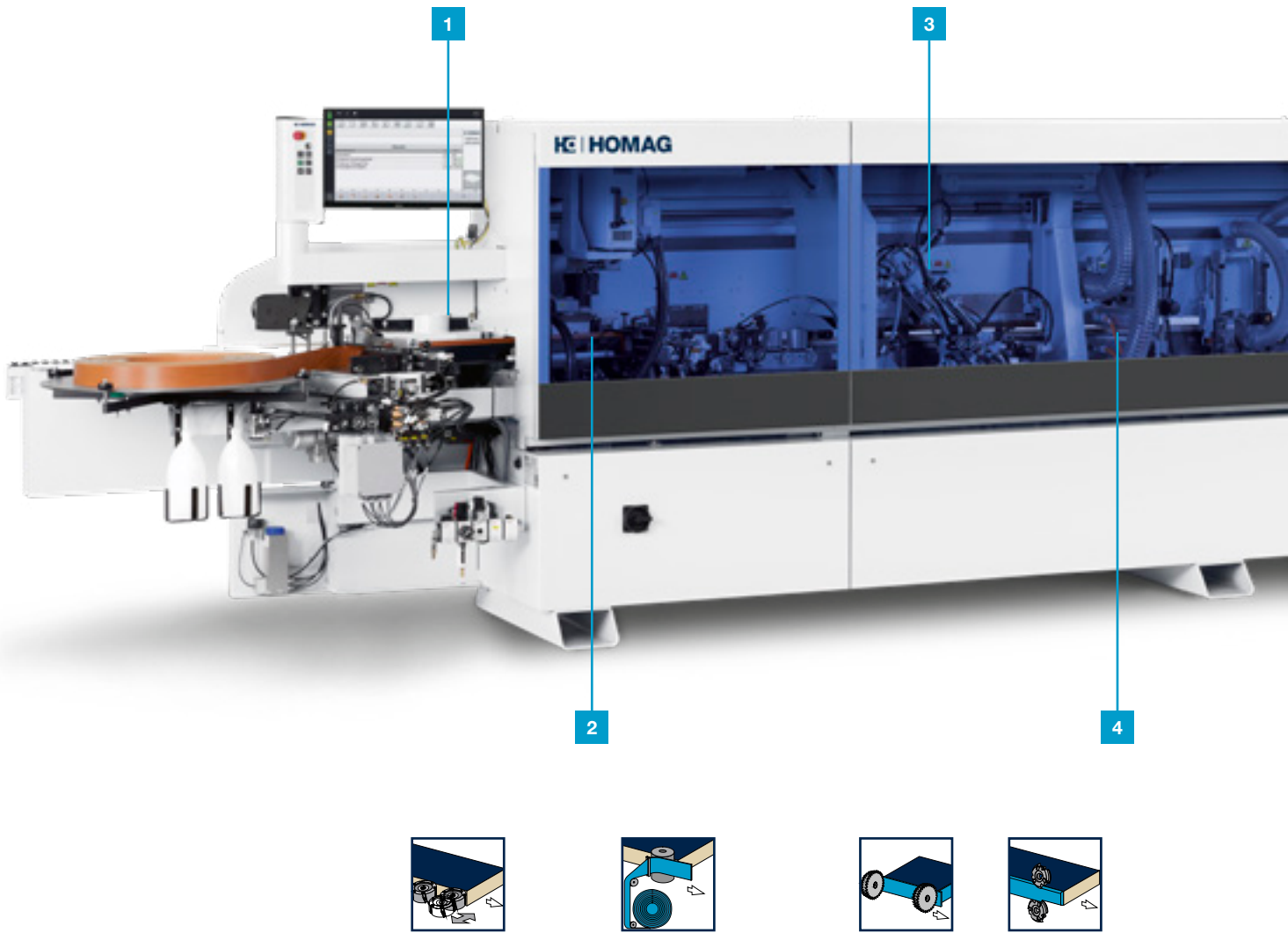

## **EDGETEQ S-380** — 1650 E–1660 E models: The powerful compact class

The Edition models already offer a high degree of automation in the standard features and the simple processing of several radii in the standard version. The basic versions are equipped with a joint trimming unit, a precision Quickmelt gluing station, a dual-motor snipping unit, a multi-level trimmer and a profile trimming unit. A multi-level scraper, a glue joint scraper and a

buffing unit provide the perfect finish.

The Edition models are distinguished by their high level of automation. The multi-level trimming unit and the multi-level scraper always offer the optimum radius for frequently changing applications, and therefore the best results.

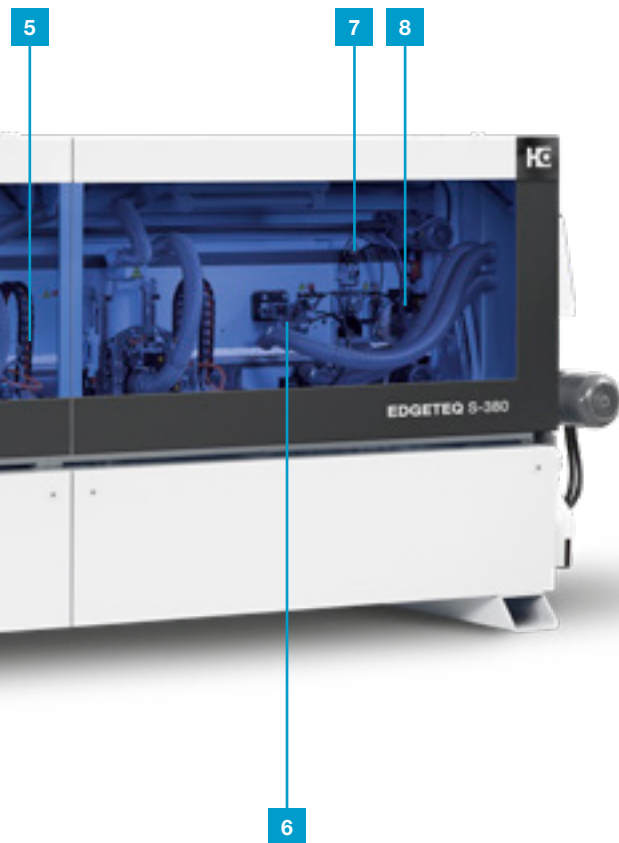

## EDGETEQ S-380

1650 E model

Feed speed: 8–20 m/min

- 1 Joint trimming unit
- 2 Gluing unit
- 3 Snipping unit with pneumatic adjustment for chamfers/straight lines and pneumatic two-point adjustment
- 4 MS40 multi-level trimming unit with pneumatic two-point adjustment
- 5 Profile trimming unit
- 6 MZ40 multi-level scraper unit
- 7 Glue joint scraper
- 8 Buffing unit

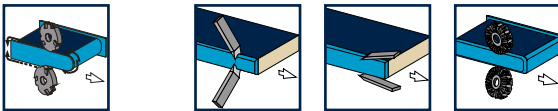

### EDGETEQ S-380 — 1660 E model

This model contains the same equipment as the 1650 E model, with the addition of a four-motor profile trimming unit.

## **EDGETEQ S-380 profiLine:** The best results with any edge material

The EDGETEQ S-380 profiLine series offers a versatile range of products for precisely positioned gluing of edges in the best HOMAG quality. The machines are available in different machine lengths that can be integrated into any machine

environment. Thanks to the individual configuration with a number of units, you can use the machines for a wide variety of production tasks.





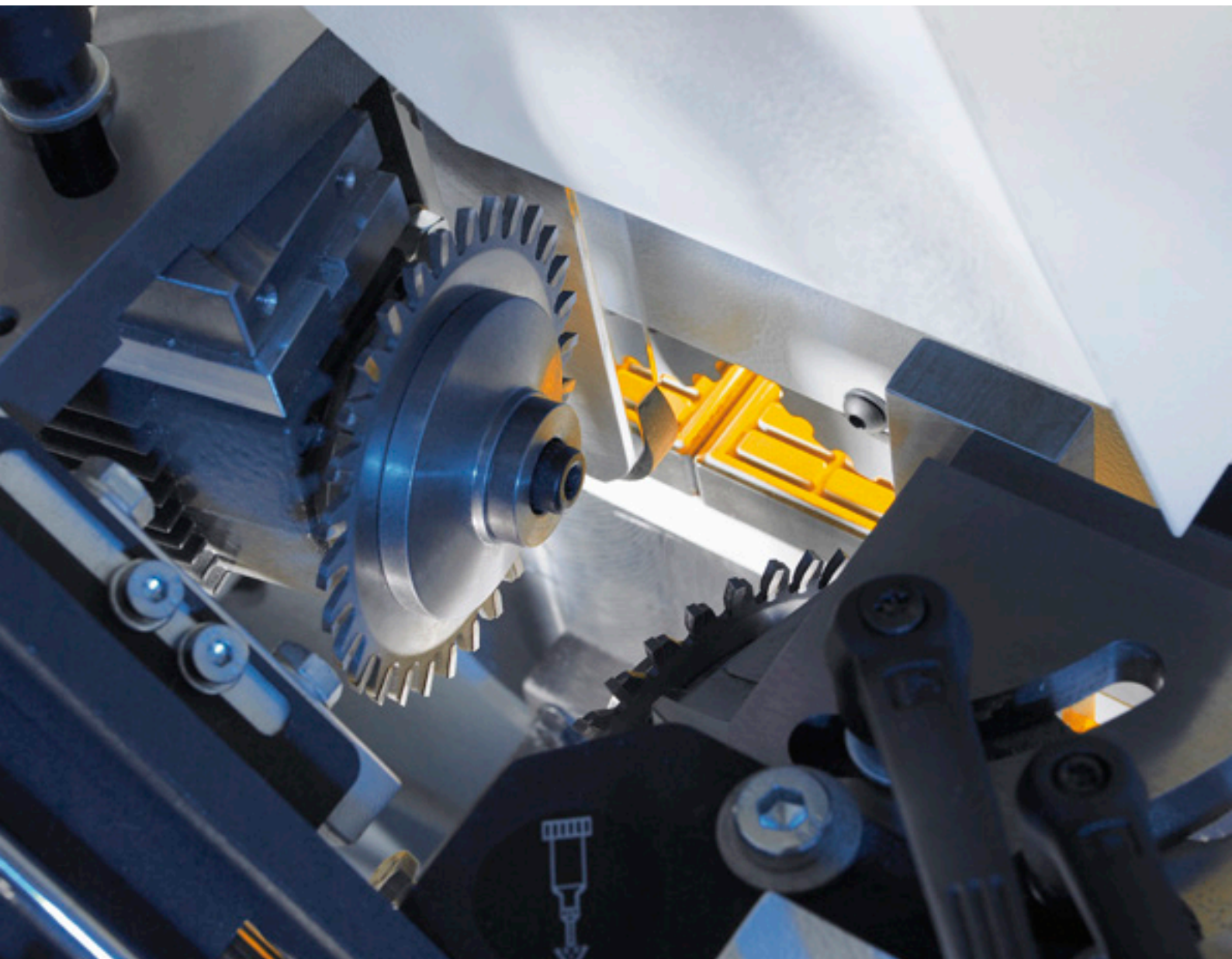

## Our unit modules: The right solution, whatever the requirement

For wide-ranging and diverse processing tasks, we use units from our tried-and-tested unit modules. We are constantly expanding our functions so we can offer you the right solution for new trends. The following pages contain units from the

fields of joint trimming, gluing, cutting, trimming, grooving and finishing. You benefit from a high level of precision, state-of-the-art technology and the ability to produce your products flexibly and efficiently.



## Guiding the workpieces

Workpieces need to be fed into machines precisely in order to achieve perfect edge quality. Take advantage of the benefits our solutions have to offer, such as infeed guides, infeed blocks, sliding carriages and workpiece supports.



### Infeed block

For a minimum workpiece distance and safe operation.



### Automatic adjustment of the infeed guide

Program-controlled, precise and repeatedly accurate adjustment of the infeed guide via the infinitely variable axis.



### Air cushion table

Air cushion table for safe loading of the machine.



### Air cushion table at outfeed

Available in combination with the infeed table, size: 1275 x 650 mm

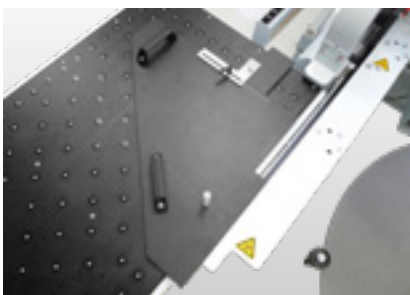

### Feed system for small parts

For easy equipping of the machine for small workpieces.



### Sliding carriage

Robust linear guide for feeding the workpieces in at a right angle.

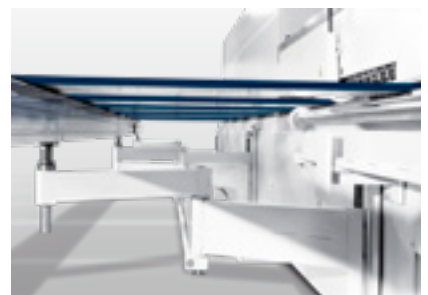

### Workpiece support in scissor design

Due to the scissor design, the workpiece support can be comfortably extended up to 1000 mm.

## Sprayers

Sprayers improve the edge quality throughout processing. Separating agents prevent hot-melt glue residues forming deposits and anti-static agents prevent plastic chips forming deposits.

The adhesive residues can be easily removed using cleaning spray. Lubricants prevent shiny marks on the workpieces and protect sensitive surfaces before trimming.

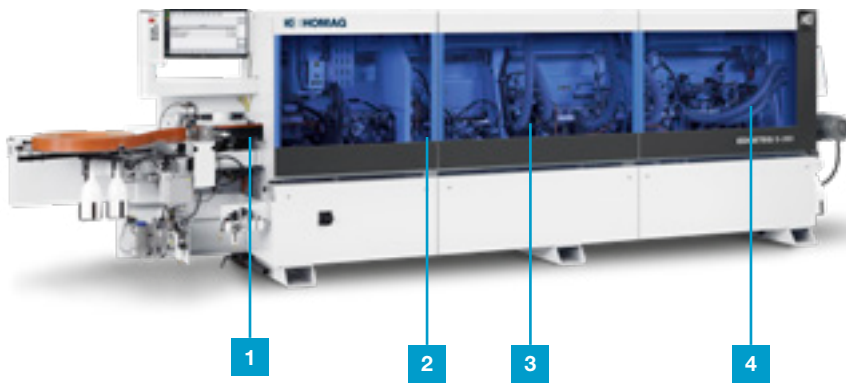

- 1** Separating agent
- 2** Lubricant
- 3** Anti-static agent
- 4** Cleaning agent

## Joint trimming unit

Our joint trimming units form the basis for precise, absolutely straight and tear-free workpiece edges and glue joints with consistently high product quality.



### Joint trimming unit

Diamond tools ensure perfect cutting and a long service life, as well as optimal glue joint quality. The diameter is 100 mm.



# Systematic gluing

For solid gluing, it is crucial to achieve an optimum interplay of very different factors. On HOMAG machines, the workpiece preheating, application unit, quick-release system, melting unit, magazine and pressure zone are perfectly aligned.



### Workpiece preheating with heaters

High-strength gluing due to optimum workpiece preheating.

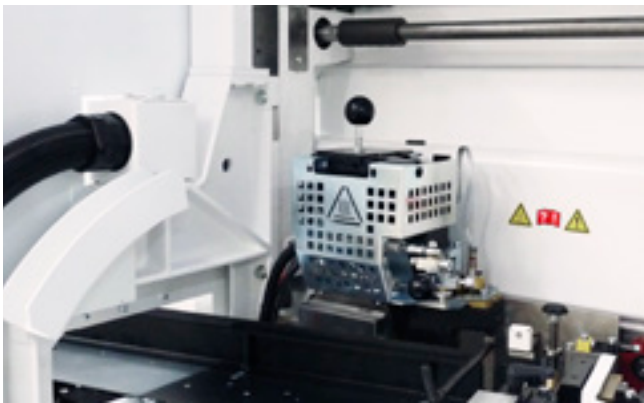

### QA65N application unit

For both EVA and PUR.



### Automatic edge infeed

For quick edge changes between different rolls of material.



### Insertion of wide solid strips

Wide, high-capacity magazine for fixed lengths and optimum access for filling.

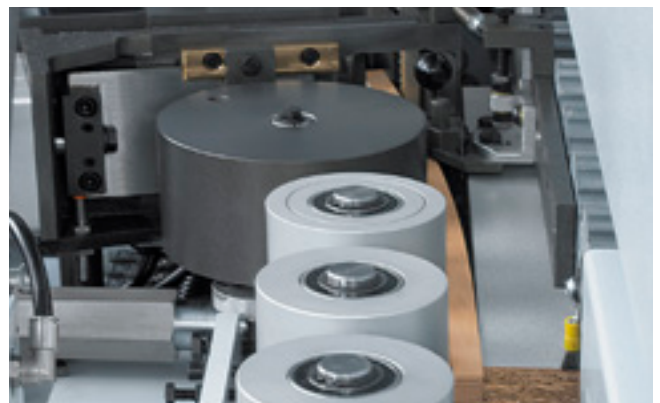

### Pressure zone

Heavy pressure zone up to 15/20-mm edge thickness and 60-mm panel height for optimum glue joint quality.

## Gluing unit — safe hot-melt glue application

HOMAG gluing units are ideal for quick, solid gluing. The heated gluing roller ensures an optimal adhesive temperature. On request, the gluing unit can be equipped with a PUR

melting unit for you for a high level of availability and optimum gluing quality.

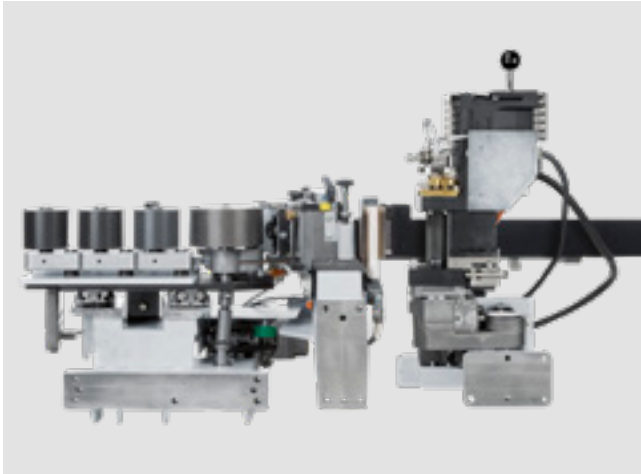

### Top gluing unit — QA65N glue application system

The application unit can be easily removed by means of a quick-change device with pneumatic interface.

## YOUR BENEFITS AT A GLANCE

- Short heat-up time thanks to sensor-controlled level regulation (two levels can be selected)
- The application unit can be easily removed thanks to the quick-release lock
- Pre-melting unit for melting hot-melt glue automatically or manually as required
- Gluing roller with integrated heating unit guarantees a constant temperature and viscosity for all workpiece thicknesses
- Electro-pneumatic clamping of the gluing roller and tank prevents glue contamination to the rear edge of the workpiece
- Tracing pad prevents wear to the application roller and ensures a constant glue film thickness
- Gluing roller lifts when feed stops
- Automatic glue quantity metering

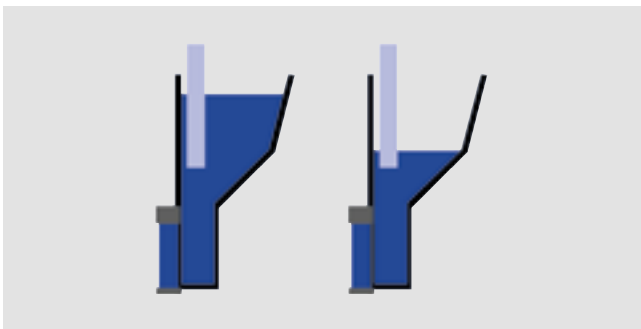

### Sensor for checking the fill level of the application unit

Switching to a lower glue level guarantees a fast heat-up time for processing small batch sizes.



## More flexibility when melting the glue



### Melting unit in three versions: EVA, PUR as well as EVA and PUR

- Efficient processing, as the glue is pre-melted
- Melting capacity max. 2.5–4 kg/h
- With the combination EVA and PUR, changing the type without cleaning is fast and easy thanks to interchangeable containers



### Interchangeable container

Easy to use for EVA and PUR adhesives



### Melting unit for EVA

High availability, as the adhesive is melted only in accordance with adhesive consumption. The Quickmelt system ensures perfect glue quality.

- Melting capacity max. 8 kg/h



### Automatic glue quantity metering

The application quantities are implemented quickly and easily via the powerTouch user interface for automatic glue quantity metering. The glue is applied in synchronous operation.

Precisely and quickly adjustable glue quantities result in:

- Optimal gluing quality
- Higher availability and performance
- Greater cost efficiency

## PUR glue and HOMAG — a strong connection

Using polyurethane (PUR) hot-melt glue increases the resistance of furniture to moisture and heat. It is ideal for use on furniture in damp areas such as bathrooms, kitchens and laboratories.



### Your HOMAG PUR benefits at a glance

- One application unit for all types of adhesive
- No additional application unit required
- Fast, powerful thin-film application by means of gluing roller with integrated heating unit
- To be used as standard from the entry-level model to the high-end machine



**Melting unit for PUR**

- Melting capacity 6 kg/h
- Temperature regulation to protect against overheating



**Vacuum container**

- Compact, portable container for the PUR application unit or a PUR melting unit with 2.5 kg/h capacity
- No vacuum pump and no nitrogen necessary



**Service station**

- Preheating and cleaning station for the QA65N application unit with one storage position
- High level of flexibility thanks to up to two vacuum containers for one QA65N application unit or one PUR melting unit with 2.5 kg/h capacity
- No vacuum pump and no nitrogen necessary
- With optional accessories also for application units for the powerEdge Pro/Pro Duo CNC edge banding unit

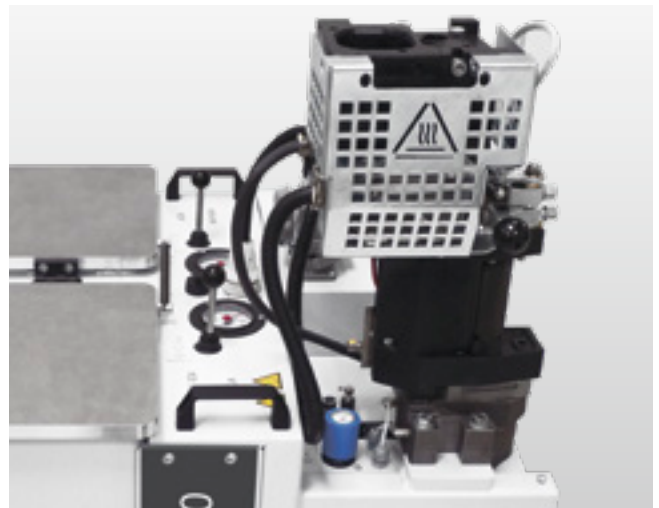

**Service station**

The image shows the application unit in the holding device for preheating

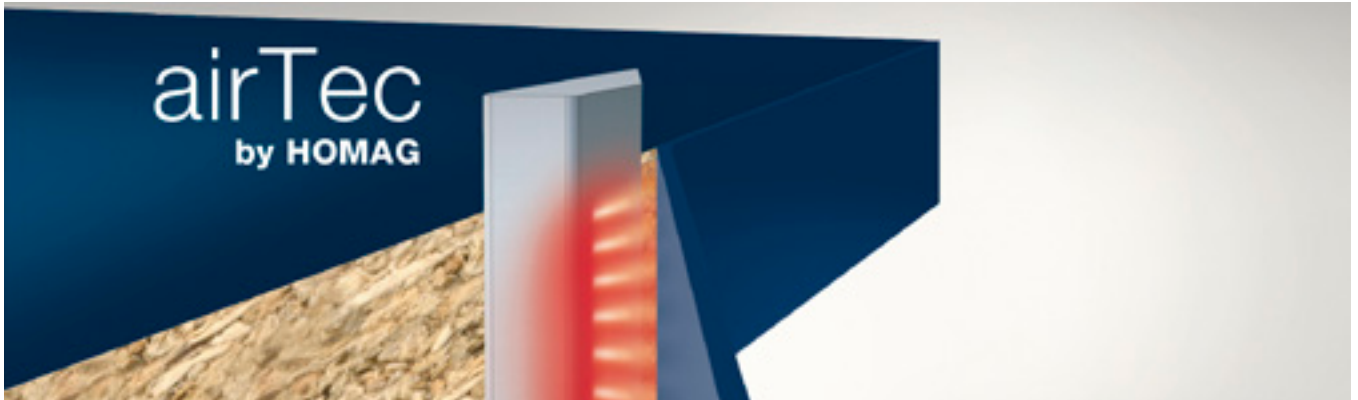

## airTec — an ideal introduction to zero joint technology

The airTec process has established itself as the optimum zero joint solution for woodworking shops and medium-sized companies. At the core of the HOMAG airTec unit is a powerful, resource-conserving rotary fan heater, which is

also distinguished by a significantly reduced noise output. All laser-compatible edging types that are currently available on the market can be processed with airTec. This means great flexibility for all materials and colors.



### Gluing edges "without joints"

In the airTec process, the edge and panel are bonded using hot air. This requires the use of special edges. These consist of a decorative layer and a functional layer. Using the HOMAG airTec unit, the functional layer is melted at a constant temperature and volume outflow and optimally applied to the narrow surface.



### Easy integration

The airTec reactivation unit is installed in such a way that you can work with either the standard application unit or the airTec system. The anti-static spraying device for an optimum processing result is included in the standard version of all airTec units.

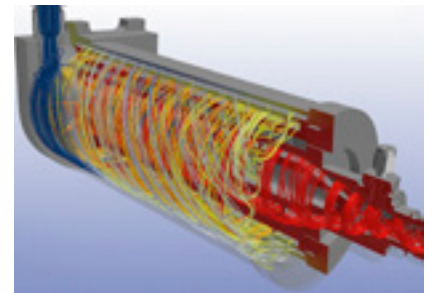

### Innovative rotary fan heater

This source of energy heats the air and simultaneously serves as heat storage that can then be used to heat the air again. In addition, less air is required and the heating effect on the surrounding area is minimized. Any noise is almost exclusively produced during the activation process and is below the noise level of other processing units.



## Snipping unit for cutting the overhangs on the front sides

The snipping unit prepares the workpieces for subsequent trimming perfectly. The front side can be snipped straight or with a chamfer.



### Snipping unit

An exact snipping cut thanks to a robust snipping unit with extremely precise linear guide and workpiece gap optimization (optional) for a higher output in the same processing time. Soft-touch function for optimum snipping results even at high feed speeds.

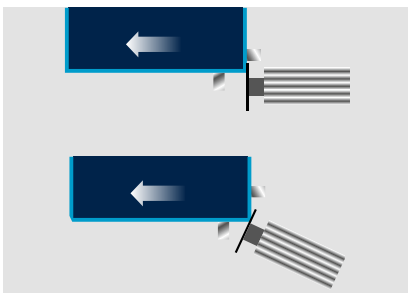
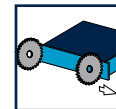

### Automation in the standard version

Programmable adjustment of the snipping motor for chamfers/straight lines, for a quick change between straight-line snipping and cutting with a chamfer.

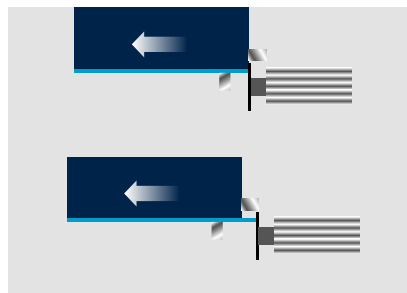

### Can be automated

For a quick change between flush snipping, e.g. of solid strips or shelves, and cutting with an overhang, e.g. for post-trimming with a profile trimming unit.

## Trimming units for flush trimming

The pre-trimming and fine trimming units offer the perfect solutions for processing edge overhangs. The trimming units are only equipped with tools that collect the chips in a controlled manner.

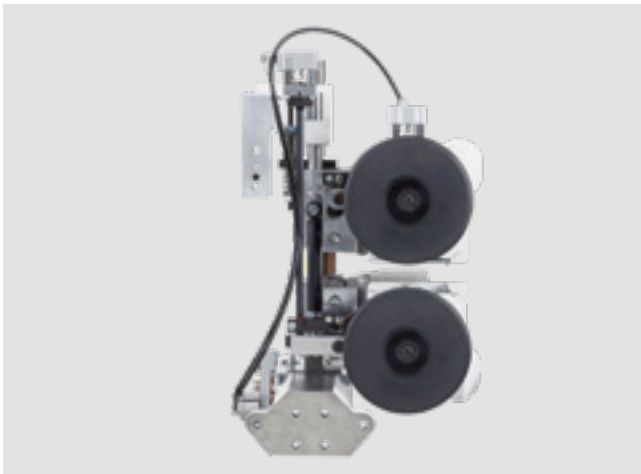

### Pre-trimming unit

For pre-trimming all standard edge types.

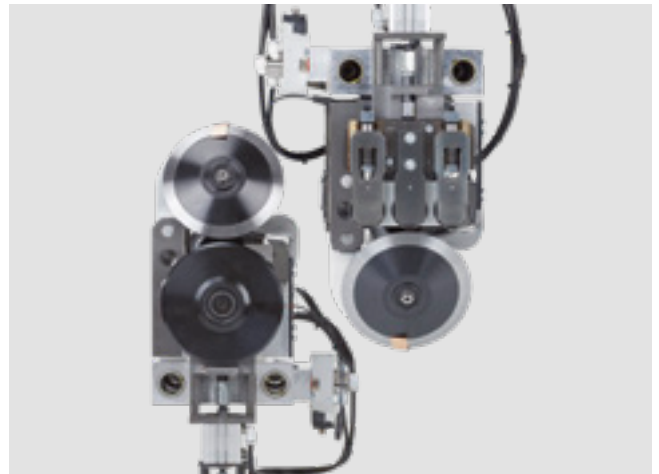

### Fine trimming unit

For trimming chamfers and radii with optimized chip extraction and manual adjustment.

### Can be automated

Infinitely variable chamfer/radius adjustment for fast change of processing, for example from a 0.3-mm edge to a 2-mm edge.

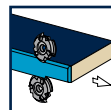
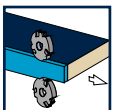

## Trimming with multi-level technology

The range of edges and panel materials is continually growing and so is the demand for flexibility. It is immaterial if edges are made from plastic, solid wood or veneer, or if workpieces have high-gloss surfaces. The multi-level trimming unit always offers the optimum radius for frequently changing applications, and therefore the best results.

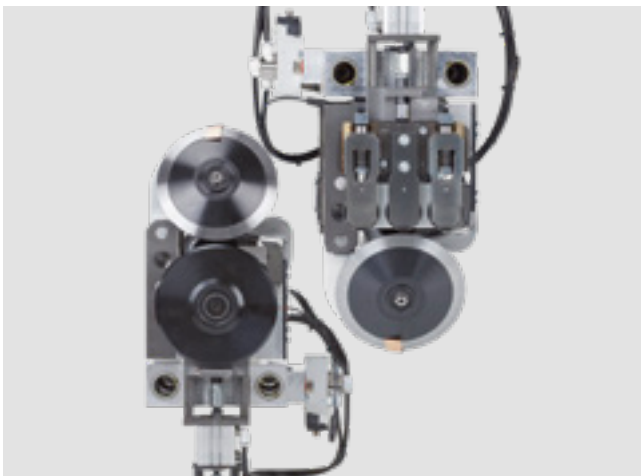

### Multi-level trimming unit MS 40/45

Fully automatic changeover to three different profiles using servo motors\*. The photo shows the nesting package.

\* Servo drives consist of motors with infinitely variable adjustment. They impress thanks to a high positioning accuracy and are particularly suitable for small positioning distances.

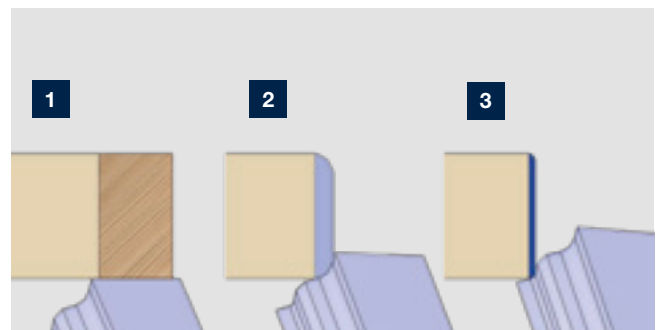

- 1** Flat (MS 40/45)
- 2** Profile 1
- 3** Profile 2

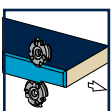

# Profile trimming units

The profile trimming units are universal. As a user, you have the option to manually adjust the units or perform programming using the control system. The design is then

executed up to a speed of 20 m/min with extreme precision. Our profile trimming units enable both corner rounding and trimming of the upper and bottom edge overhangs.



### FF20 profile trimming unit

For rounding corners on thick PVC edges, as well as top edges on post-forming and soft-forming parts. Equipped with automatic adjustment between thin and thick edges. Workpiece thickness 60 mm.

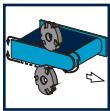

### MF50 multifunction trimming unit

For processing edge overhangs on the upper and bottom edge of the workpiece and copying of the corners of the front and rear edge. Equipped with automatic adjustment between thin and thick edges. Workpiece thickness 60 mm.

#### Can be automated

Adjustment to two different radii as well as automatic adjustment of the detector rollers.

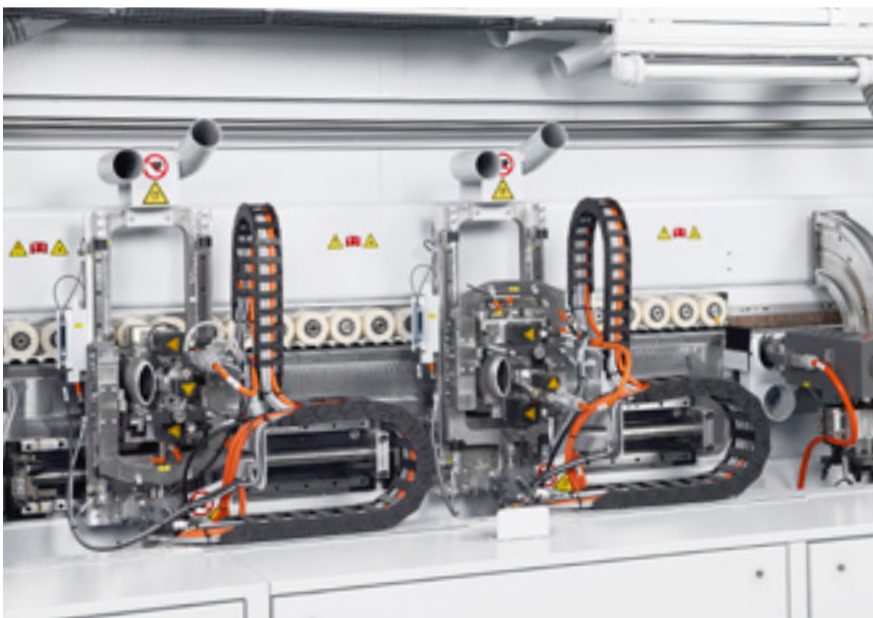
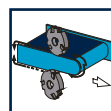

### MF60 Servotrim multifunction profile trimming unit

For processing edge overhangs on the upper and bottom edge of the workpiece and for corner rounding of the front and rear edge. Servo-controlled motion sequence with Soft Touch function, for optimum processing of high-gloss surfaces or lightweight panels, for example. Workpiece thickness 60 mm.

#### Can be automated

Adjustment to two different radii as well as automatic adjustment of the detector rollers.

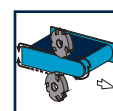



**Highlights of the new tool system**

- Robust mechanics
- Closed system that can be easily maintained from the outside without being dismantled
- Sensory detection of the tool levels — for clear determination of the tool position
- Safe tool positioning thanks to special adjusting axes

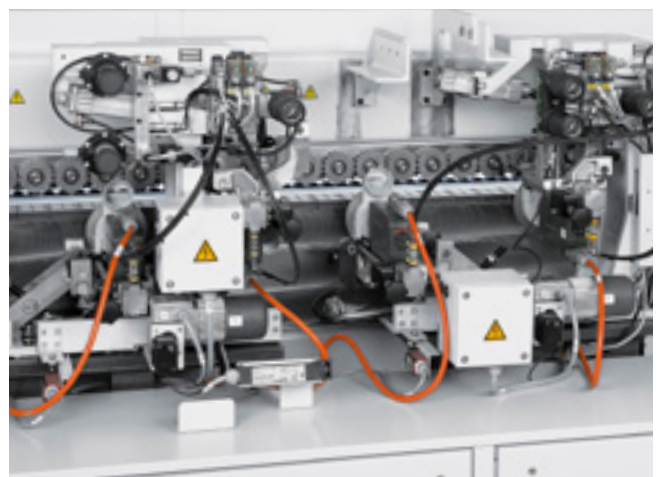

**FF12 profile trimming unit**

For corner rounding of thick PVC edges as well as top edges on post-forming and soft-forming parts up to a feed speed of 20 m/min. Equipped with automatic adjustment to all edge thicknesses. Workpiece thickness up to 60 mm.

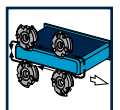

**Structural shelves**

Profile trimming is also possible on workpiece sides without an edge. This applies not only to structural shelves, but also to upper and lower shelves, shelf inserts and partition panels.



## Groove milling unit

A swiveling groove milling unit is available for grooving. If required, the workpiece underside and the front sides can be grooved.



### Swiveling groove milling unit

For grooving the workpiece underside and the front sides. For producing continuous, non-continuous and interrupted grooves.



### Safety pressure device

For grooving in solid wood strips in synchronous operation. On the 1670 FGC model.

# Finishing units

Perfectly coordinated finishing units enhance the quality of your products. With optimally matched finishing units, HOMAG makes the quality of your products perfect.

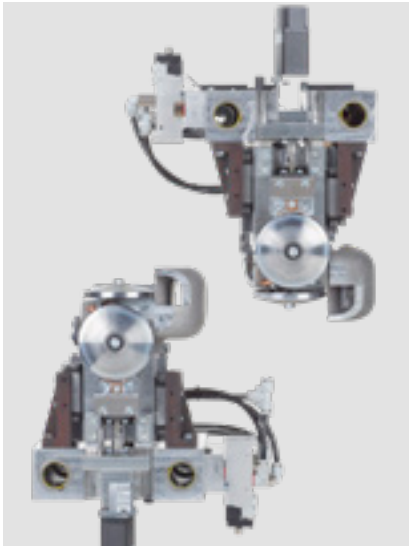

### MZ40 multi-level scraper unit

Fully automatic conversion to two different profiles through the use of servo motors with infinitely variable adjustment.

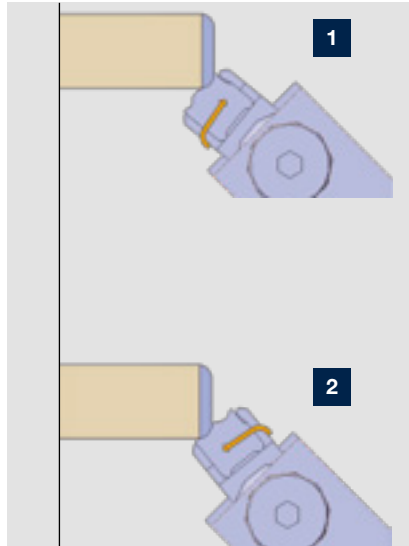

1 Profile 1

2 Profile 2

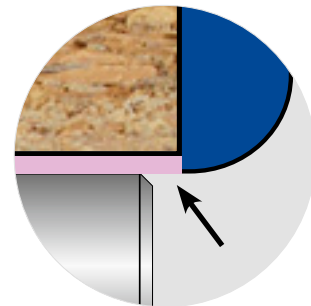

Optimum compensation for protective films

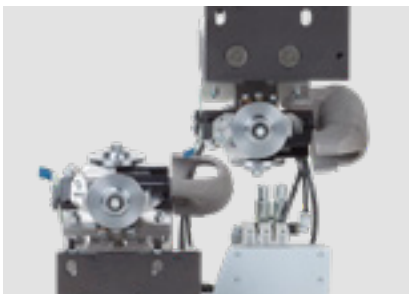

### Profile scraper unit

Unit for smoothing radii and chamfers. Equipped with changer heads to allow rapid profile changes.



### Glue joint scraper unit

For the perfect finish.



### Buffing unit

For polishing edges for a natural color.

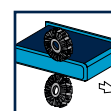
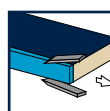
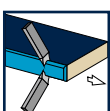

## Special processing

To extend the range of functions of the machines for individual situations, we offer solutions for processing workpieces with protective film/high gloss, as well as for processing, for

example, sharp-angled or blunt-angled parts or parts with hinge holes, as produced in nesting.

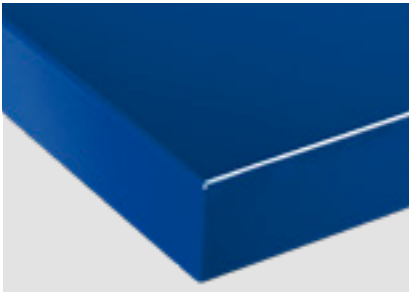

### Workpieces with protective film/high gloss

For perfect high-gloss parts, the lubricant spraying device and the motorized top roll pressure unit are used.



### Lubricant spraying device



### Motorized top roll pressure unit

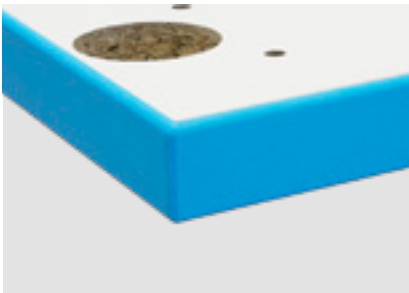

### Workpieces with hinge holes (nesting method) or sharp/blunt-angled workpieces

Depending on the unit configuration, different tracing elements are installed. They are ideal for processing parts with hinge holes, such as those produced in nesting, as well as sharp-angled or blunt-angled parts.



### Tracing elements for hinge holes



### Small parts processing

Greater flexibility in the production spectrum, as optimum workpiece guidance and processing are also provided for workpiece lengths < 240 mm to a minimum of 120 mm. This is achieved by a narrow roller pitch at the top roll pressure unit.



# LOOPTEQ returns: Increased productivity for your edge banding machine

Workpiece returns of the LOOPTEQ series are an optimal supplement to the machines of the EDGETEQ S-380 series. Single-person operation enables you to optimize your workpiece return flow, resulting in a streamlined and efficient

production process. Depending on your requirements, you can combine your machine with a LOOPTEQ O-200 or a LOOPTEQ O-300.

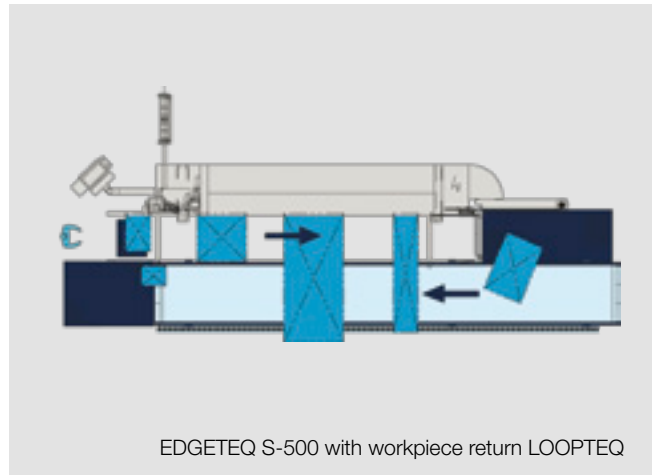
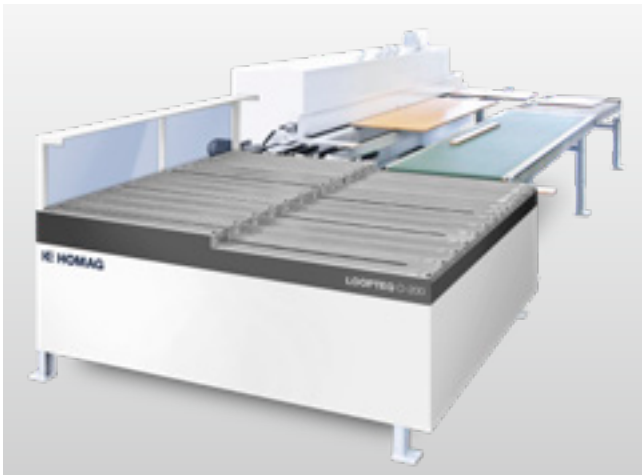

## LOOPTEQ O-200 — ideal for small, narrow and medium-sized workpieces

- Fast return on investment — pays for itself from just nine hours of operating time per week
- Flexible personnel organization thanks to cost-effective single-person operation
- Ergonomic working — manual parts handling is reduced to a minimum
- Better quality control — quick response to material adjustments

## LOOPTEQ O-300 — ideal for a wide range of parts, from small and light workpieces to large and heavy ones

- Fast return on investment — pays for itself from just 15 hours of operating time per week
- Minimal quality costs — gentle workpiece handling with air cushion table
- Flexible personnel organization thanks to cost-effective single-person operation
- Ergonomic operation — staff no longer have to endure heavy physical work

## Technical data

	LOOPTEQ O-200	LOOPTEQ O-300 TFU 140/20	LOOPTEQ O-300 TFU 140/25
<b>Workpiece length (mm)</b>	300–2500	300–2500	240–2700
<b>Workpiece width (mm)</b>	50–1450	60–800	60–1000
<b>Workpiece thickness (mm)</b>	8–60	8–60	8–60
<b>FOUR-SIDED PROCESSING*</b>			
<b>Min. workpiece size (mm)</b>	300 x 300	300 x 80	240 x 80
<b>Max. workpiece size (mm)</b>	1450 x 1450	2000 x 800	2500 x 1000
<b>MISCELLANEOUS</b>			
<b>Max. workpiece weight (kg)</b>	50	50	50
<b>Surface weight (kg/m<sup>2</sup>)</b>	25	25	25

\*In four-sided processing, larger parts can be returned or ejected with manual assistance in the event of transverse offset or rotation.



## Apps and digital assistants.

Quick and easy support in your machine environment.

Some people still use pen and paper to create their cutting patterns. But they look at their smartphone if they want to know what the weather is like – instead of looking out of the window. We asked ourselves: why not combine the best of both? Our apps and digital solutions make your everyday work easier: machines, material, tools, cutting patterns, components – you always have everything in your pocket or on your desk.



More information at [digital.homag.com](https://digital.homag.com)

### WE HAVE DEVELOPED POWERFUL AND SMART SOLUTIONS FOR YOU:

- ✓ Always low investment
- ✓ Always up to date (no updates necessary)
- ✓ Always easy to use (no complex software)
- ✓ Always helpful

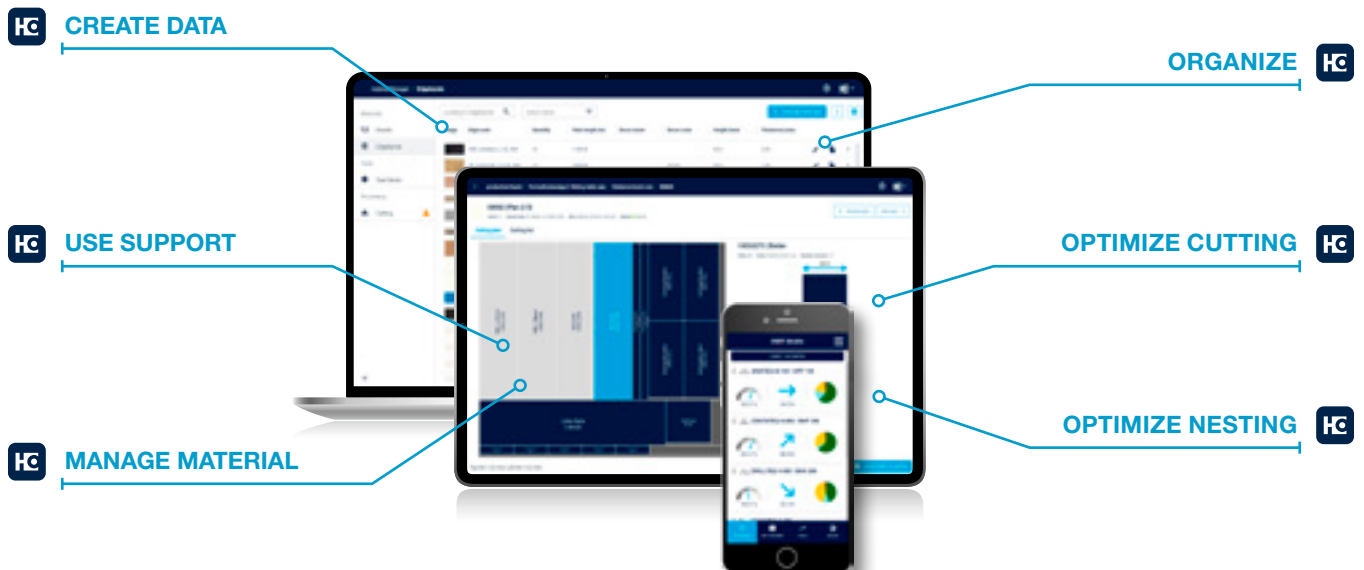



## The EDGETEQ S-380 profiLine offers more

Compared to the preconfigured models of the EDGETEQ S-380 series, the EDGETEQ S-380 profiLine series is freely configurable and offers additional units and even more flexibility.



### Several edge banding processes on one machine

The EDGETEQ S-380 profiLine offers the option of using several processes on one machine. The figure shows, for example, two melting units for the alternative processing of PUR and EVA. The airTec zero joint technology can also be used on this machine at the same time. This ensures maximum flexibility.



### Processing of edges up to 20 mm

For a high degree of flexibility in the edge selection, solid strips of up to 20 mm can be processed.

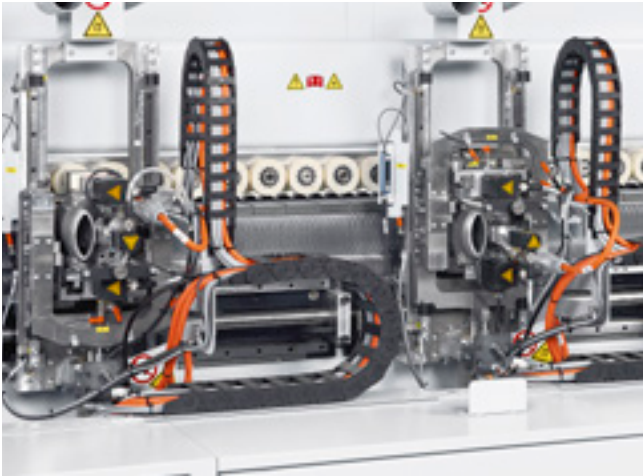

**Multiple use of the same units on one machine**

For special processing operations, it makes sense to set up a unit several times on one machine. The EDGETEQ S-380 profiLine allows you to do this. On this series, for example, the MF60 multi-function profile trimming unit can be used several times — for a wide range of different radii.



**Belt sanding unit**

For sanding straight veneer and solid edges, including oscillation in the standard version.



**Universal trimming unit for grooving and profiling**

Universal unit with high performance for grooving and profiling. Flexible thanks to unlimited configuration options.



**Safety pressure device**

For grooving in solid wood strips in synchronous operation.

## Our successful powerTouch philosophy — simple, standardized, ergonomic, evolutionary

HOMAG machines are designed so that simple operation and reliable control are a matter of course. Our innovative touchscreen operating philosophy combines design and function in one control system.

The full HD multi-touch monitor, ergonomic touch operation, easy navigation and the standardized user interface increase processing efficiency.

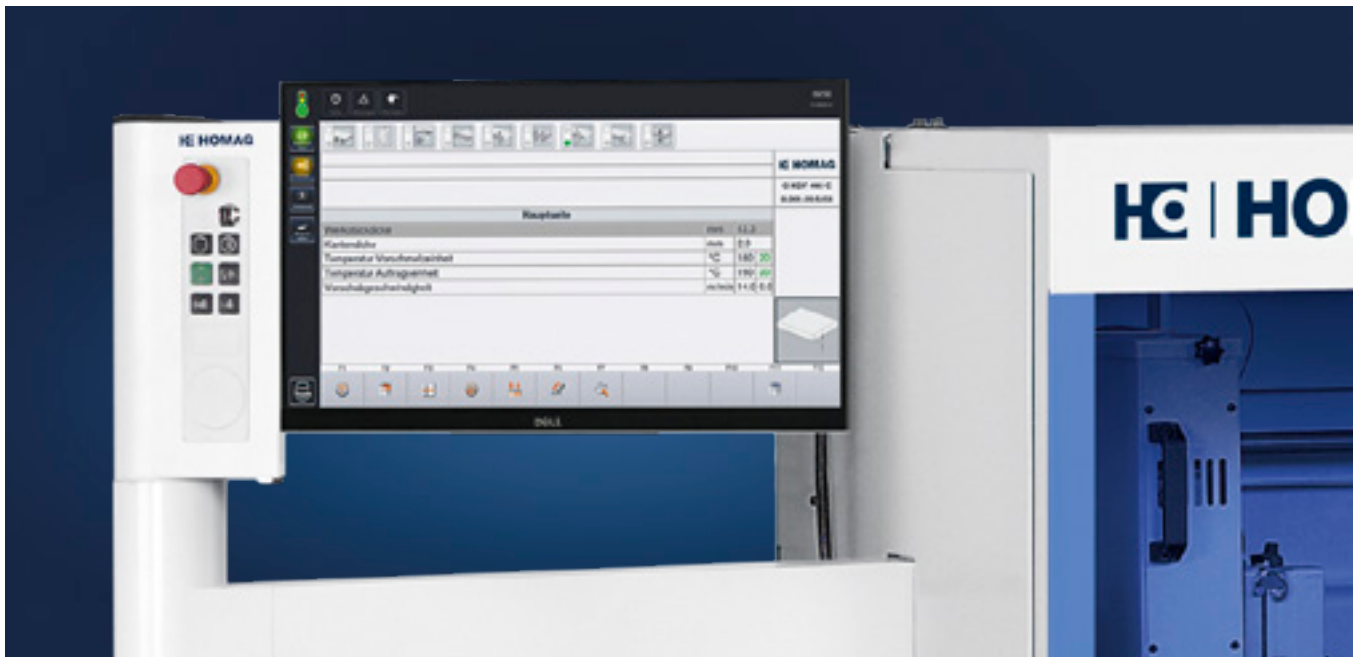

Standardized control elements and software modules ensure that all HOMAG edge banding machines from the EDGETEQ S-240 1240 FC model can be operated in the same way using this concept. They differ only in a few machine-specific details.

This not only simplifies operating different machines, but also makes for greater efficiency by significantly reducing the time spent on training and service.

# Control with powerTouch

Control machine functions directly using the multi-touch monitor in widescreen format. The ergonomic design and numerous help and assistant functions simplify operation significantly.



## Standardized

The powerTouch control system of HOMAG machines is characterized by the standardized operating elements, software modules and standardized design. These allow different HOMAG machines to be controlled in the same way.



## Ergonomic

Intuitive, direct operation via the touchscreen monitor.



## Evolutionary

Design and function are combined in one control system. The innovative powerTouch machine control unit is combined with the latest operating concepts from smartphones and tablet PCs.

## THE BENEFITS

- 24" monitor with full HD resolution
- Quick overview of the machine status
- Easy, user-oriented navigation
- Guided path to production readiness using a traffic light indicator
- Ergonomic design of the operating panel
- Intuitive, natural operation of the machine
- Use of gestures, e.g. scrolling, swiping

**TECHNICAL DATA: EDGETEQ S-380 – MODELLE 1600**

	1650 FC	1670 FGC	1650 HF	1660 HF
<b>Overall length (mm)</b>	5.773	6.273	6.773	6.273
<b>Adjustable feed (m/min)</b>	8 – 18 (20 opt.)			
<b>WORKING DIMENSIONS</b>				
<b>Workpiece width (mm) *</b>	70			
For workpiece thickness 8–22 mm				
<b>Workpiece thickness (mm)</b>	8 – 60			
<b>Edge thickness rollers (mm)</b>	0,3 – 3			
<b>Edge thickness strips/moldings (mm)</b>	0,4 – 12	0,4 – 12	0,4 – 15 **	0,4 – 15

\* Dependent on the workpiece thickness

\*\* Dependent on the equipment

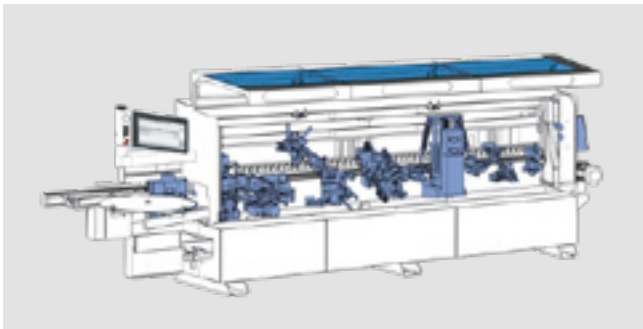

**EDGETEQ S-380 – Modell 1650 FC**

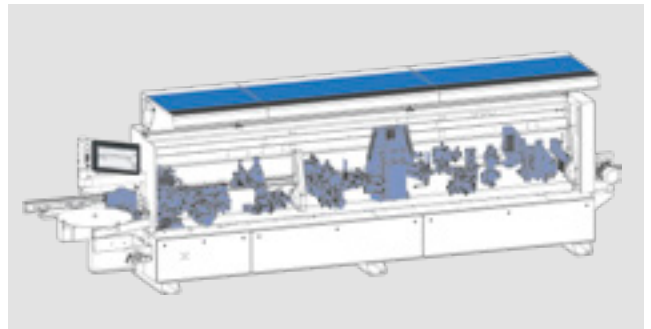

**EDGETEQ S-380 – Modell 1670 FGC**

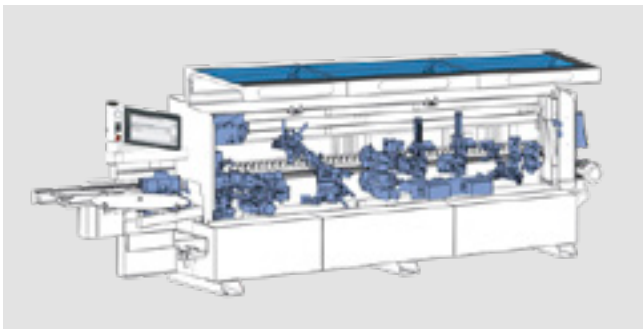

**EDGETEQ S-380 – Modell 1650 HF**

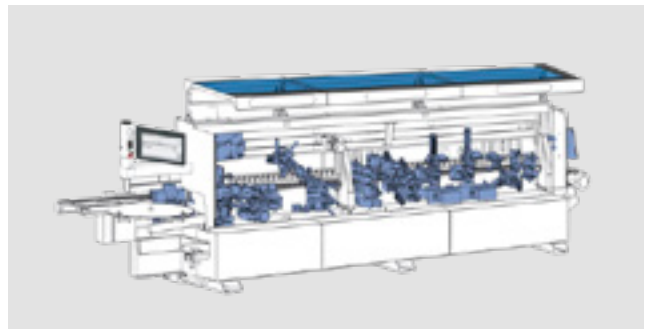

**EDGETEQ S-380 – Modell 1660 HF**



**TECHNICAL DATA: EDGETEQ S-380 – MODELL 1650 E, 1660 E AND EDGETEQ S-380 PROFILINE**

	1650 E	1660 E	1662 E	1672 E	PROFILINE
<b>Overall length (mm)</b>	5.773	6.573	6.575	7.075	4.773 – 8.273
<b>Adjustable feed (m/min)</b>	8 – 20				8 – 20
<b>WORKING DIMENSIONS</b>					
<b>Workpiece width (mm) *</b>					
For workpiece thickness 8–22 mm	70				70
<b>Workpiece thickness (mm)</b>	8 – 60				8 – 60
<b>Edge thickness rollers (mm)</b>	0,3 – 3				0,3 – 3
<b>Edge thickness strips/moldings (mm)</b>	0,4 – 12				0,4 – 20

\* Dependent on the workpiece thickness

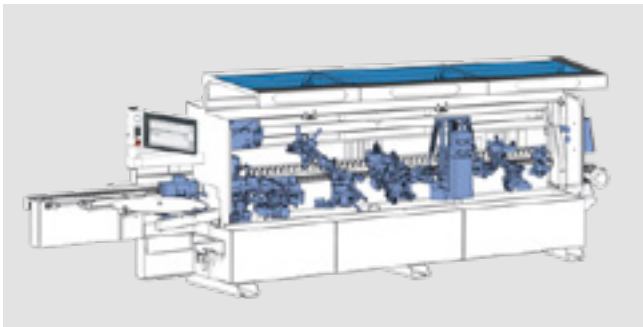

**EDGETEQ S-380 – Modell 1650 E**

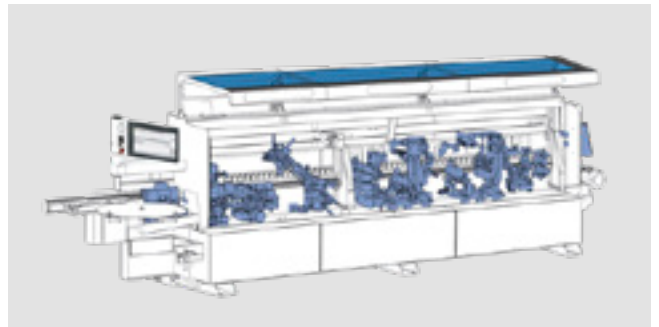

**EDGETEQ S-380 – Modell 1660 E**

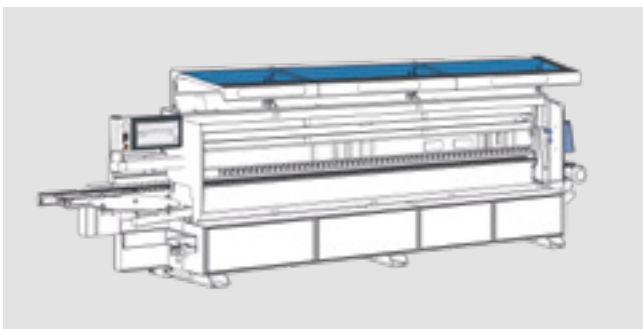

**EDGETEQ S-380 profiLine**

# VALYOU

Our Mission, Your Performance.

## LIFE CYCLE SERVICES

Improved performance, more efficient processes, faster help, assurance of availability and smarter workin

### TEAM & COVERAGE

Largest global service network in the industry with over 1,350 personnel.

### INSTALLATION & COMMISSIONING

For a smooth start, we only let proven experts manage your setup.

### OPERATION & CONTROL

After teaching your personnel the intuitive control system, our clever apps help to make the operator's life much easier.

### MAINTENANCE & SERVICING

To keep things running, we're happy to take a preventative approach. You decide how often and how intensively you want the support to be. As we all know, prevention is better than the cure.

### eSHOP & ONLINE ADVANTAGE

A few clicks and it's fixed. Receive exclusive advantages by ordering spare parts online, depending on market availability. [shop.homag.com](http://shop.homag.com)

### HOTLINE & READINESS

When there's an emergency, we're here. Direct by phone, digitally via app or video, or with on-site support. We are close to you with over 90 regional service organizations worldwide. With more than 35,000 spare parts immediately available, we can deliver 85% of your orders fast.

### TRAINING & EDUCATION

With classroom, live online or eLearning training, we offer flexible options to help you get knowledge. We conduct over 4,000 customer training courses every year, and we even have our own training centers in 19 countries

### MODERNIZATION & IMPROVEMENT

Our modernization program is tailored to your machines and processes. We can evaluate your data and situation and advise you on the next step.

### ANALYSIS & SUSTAINABILITY

On request, we analyze all your processes with proven tools and procedures (LeanSixSigma). We have a large, certified team of experts for this purpose.

### FINANCING & CONSULTING

We offer you tailor-made financing concepts worldwide. With more than 60 years of experience and a close partner network of prominent banks and insurance companies to help us to find the right solution for you, we're always transparent and reliable in processing.

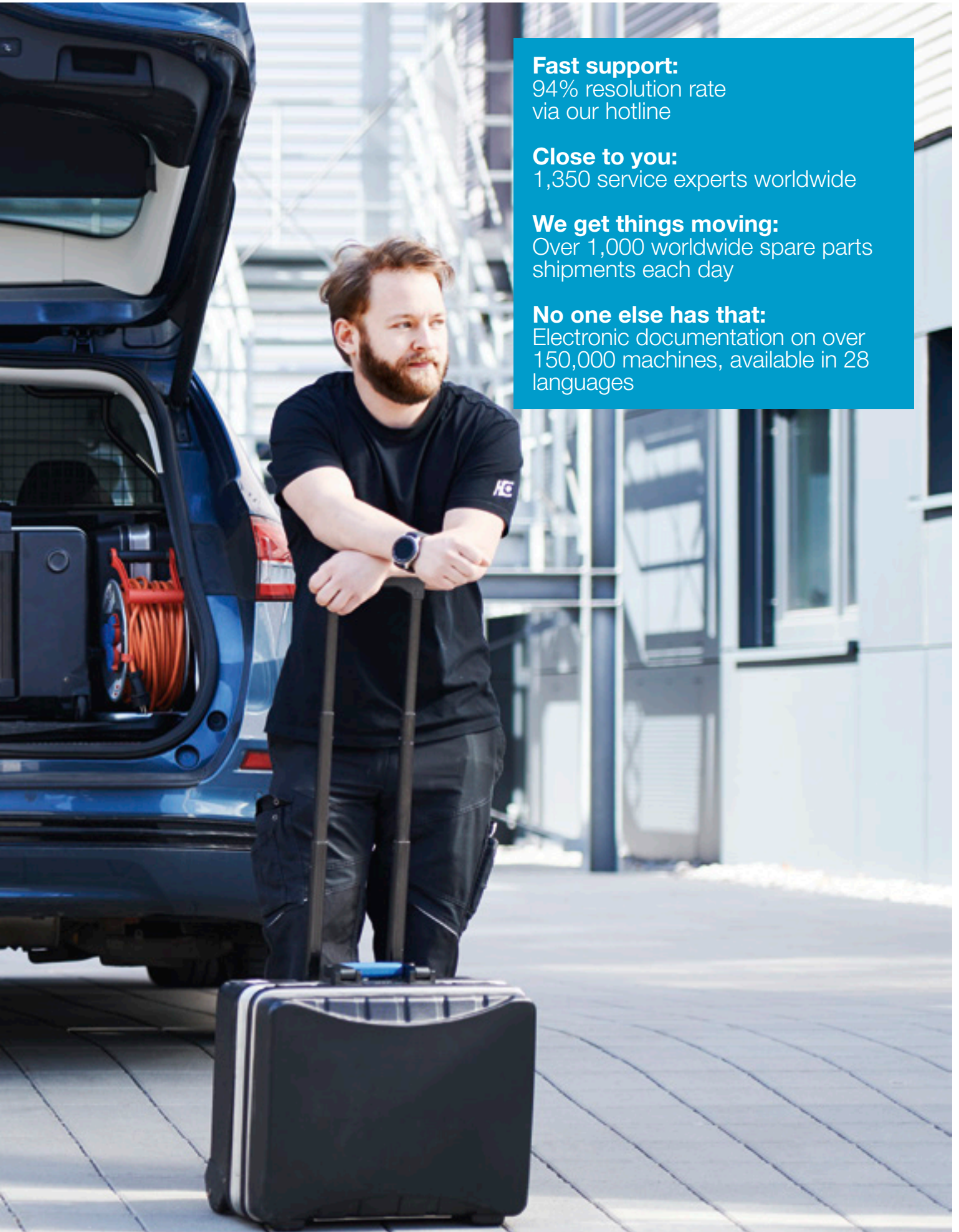
**Fast support:**

94% resolution rate  
via our hotline

**Close to you:**

1,350 service experts worldwide

**We get things moving:**

Over 1,000 worldwide spare parts  
shipments each day

**No one else has that:**

Electronic documentation on over  
150,000 machines, available in 28  
languages

Status 05/23 | Technical changes, print errors and mistakes reserved. Pictures may show special equipment.



**HOMAG Group AG**

[info@homag.com](mailto:info@homag.com)

[www.homag.com](http://www.homag.com)

**YOUR SOLUTION**