

# WIDEBELT SANDING

**KUNDIG**

**PRIMO · DUPLEX · TRIPLEX**

This is how sanding  
can be a real pleasure!

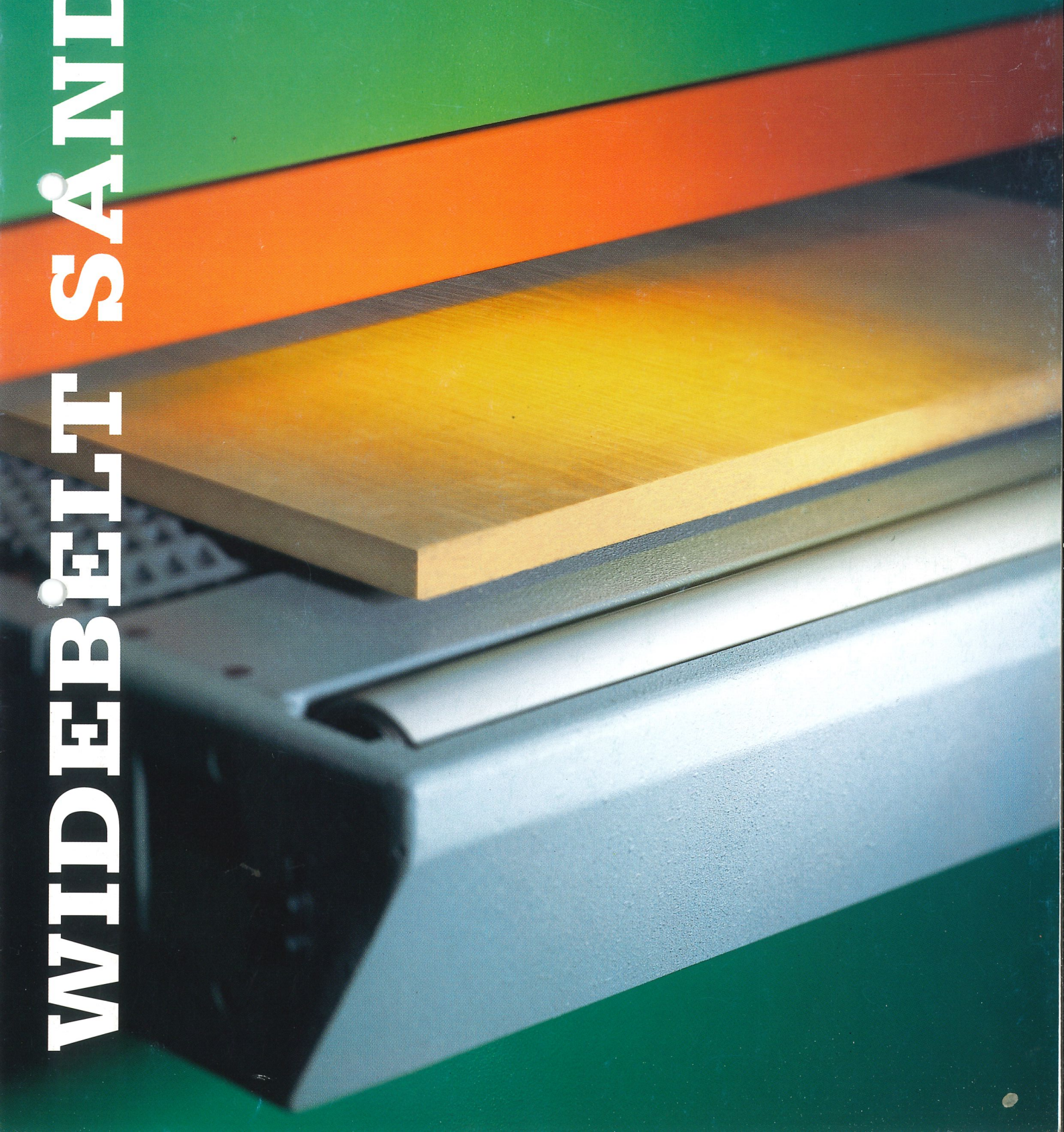

# KÜNDIG - WIDEBELT SANDING

## A SOLID BASIS FOR INDUSTRY AND CRAFTSMANSHIP

Each generation of KÜNDIG Sanding Machines satisfies the highest demands for ease of operation, reliability and for an

excellent price/performance ratio. By using our technique you benefit from our many decades of experience and from a high production standard. With a KÜNDIG widebelt sander you get a machine entirely suited to your needs, which being perfectly constructed makes your work easier.

Easy operation  
thanks to the ENORMATIC system

For every purpose  
the right model

1-belt = PRIMO  
2-belt = DUPLEX  
3-belt = TRIPLEX

Adjustment of the  
machine's upper  
part = constant  
working level



Heavy solid construction  
with a massive frame

Space saving

# KÜNDIG - WIDEBELT SANDING

## OPTIONS

KÜNDIG sanding machines are optionally extensible sanding systems for high demands. According to your requirements you can decide on the optimum format by adding the available attachments to the basic version. KÜNDIG understands the needs of your craft.

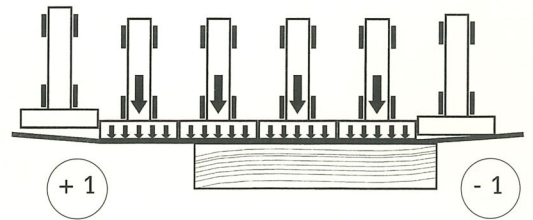
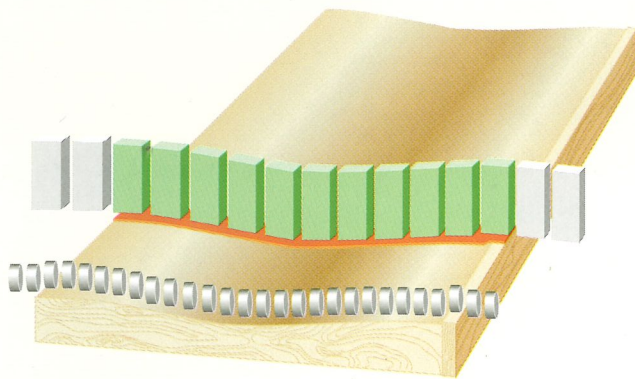

Guided segments do not tilt on the workpiece edge and therefore guarantee an optimum treatment of the delicate border area

The electronic segmented sanding pad, developed by our company engineers, offers maximum possible sanding precision both for veneered and lacquered workpieces with thickness variations. Matching sensor rollers follow the workpiece contour and electronically control the action of the respective, separately guided sanding pad segments of a suitable width (these can be 22 or 35 mm wide).

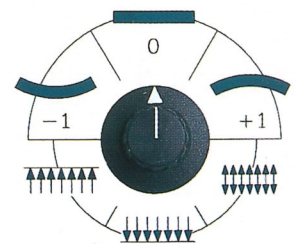

The variable edge control can be set to specifically treat the workpiece edges

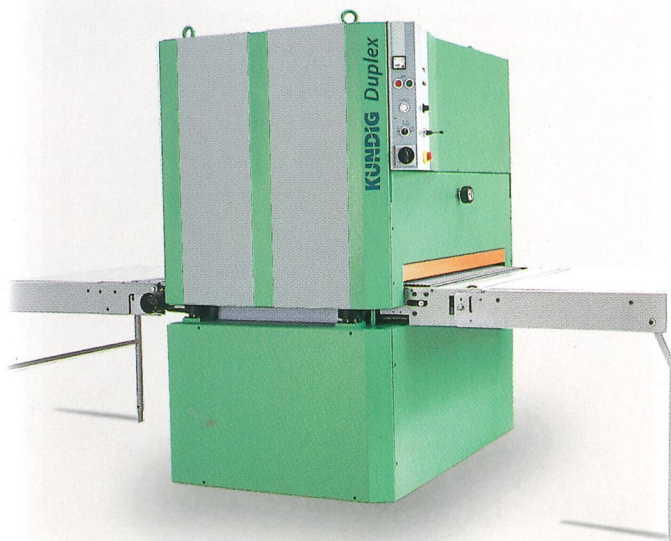

Folding table extensions facilitate infeed and outfeed of large workpieces, or during one-man-operation

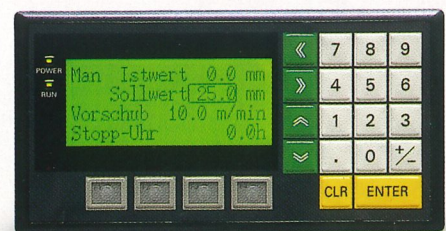

LCD read out for machine control and memory of workpiece and operation parameters

# KÜNDIG - WIDEBELT SANDING

Reliability, ease of operation and versatility have a common denominator: the detailed specification with its completeness,

RELIABLE,  
EASY TO OPERATE,  
VERSATILE

its perfection and its technical logic only available on KÜNDIG widebelt sanding machines.

Truly, a thousand times proven pioneering feat:

KÜNDIG'S adjustment of the upper section guarantees

- maximum stability
- always an equal working level

(advantages for one-man-operation or in machine lines)

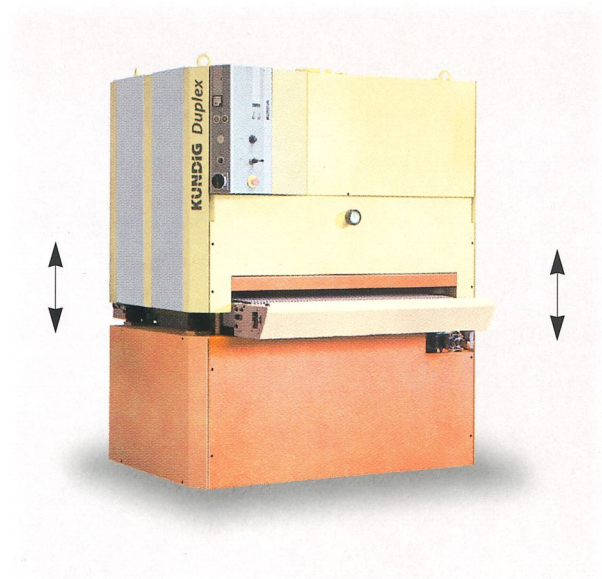

Thanks to the ENORMATIC device, the operation of the machine becomes very easy:

- Choice of sanding operation
- Fully automatic thickness adjustment linked with start of workpiece feed

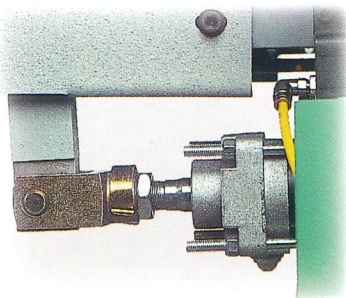

Pneumatic conveyor belt tracking



Control to adjust stock removal



Electronic adjustment of variable feed speed

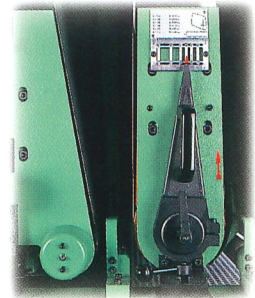

Contact roller adjustable in height with indication of grit size

# KÜNDIG - WIDEBELT SANDING



Particularly suitable for demanding small and middle size enterprises, the KÜNDIG-PRIMO with the combi unit



Productive and versatile: the well-proven KÜNDIG-DUPLEX with two sanding units



Heavy duty and designed for many different work requirements, the KÜNDIG-TRIPLEX with three sanding units

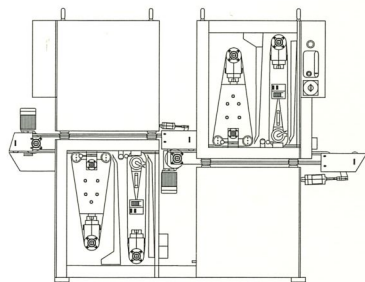

## NO PROBLEM! HERE IS THE ANSWER

... to all your sanding requirements. There is a suitable specification for all demands. The most frequently required are shown here. Others we would like to discuss with you personally.

All models are also available as BOTOP top-/bottom sanding systems



Numerically controlled wide belt sanding machine KÜNDIG-CNC for calibrating shapes into solid wood



The KÜNDIG DUPLEX 650 is the ideal solution for workpieces up to 650 mm wide

# KUNDIG - WIDEBELT SANDING

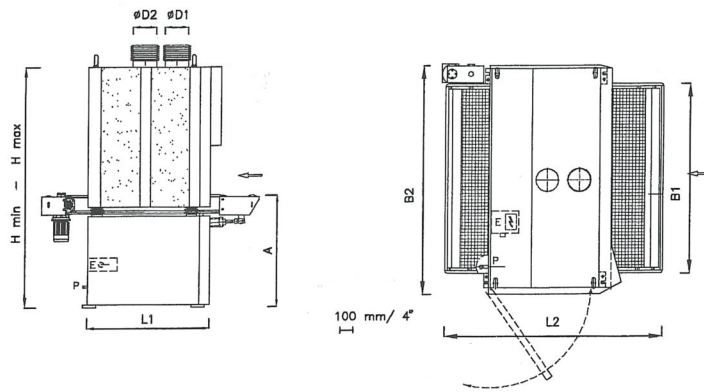

## Technical Data

Type	Kündig	Primo			Duplex			Triplex			
		1100	1350	650	1100	1350	1600	1100-WWS	1100-WSS	1350-WWS	1350-WSS
Number of units		1	1	2	2	2	2	3	3	3	3
Working width A	mm	1100	1350	650	1100	1350	1600	1100	1100	1350	1350
Workpiece thickness min.-max.	mm	3-160	3-160	3-160	3-160	3-160	3-160	3-160	3-160	3-160	3-160
Passline (constant)	mm	900	900	900	900	900	900	900	900	900	900
Belt width	mm	1120	1350	670	1120	1350	1620	1120	1120	1350	1350
Belt length	mm	2000	2000	2000	2000	2000	2000	2000	2000	2000	2000
Feed speed	m/min.	3 - 15	3 - 15	3 - 15	3 - 15	3 - 15	3 - 15	3 - 15	3 - 15	3 - 15	3 - 15
Main motor(s) power	kW	9	11	11	15	15	22	18,5	15	18,5	15
Feed motor power	kW	0,75	0,75	0,75	0,75	0,75	1,5	1,1	1,1	1,5	1,1
Height adjustm. motor power	kW	0,75	0,75	0,75	0,75	0,75	0,75	0,75	0,75	0,75	0,75
Brush motor power (option.)	kW	1,1	1,1	1,1	1,1	1,1	1,1	1,1	1,1	1,1	1,1
Total connection power	kW	10,5	12,5	10,5	16,5	16,5	16,5	35	27,5	35	27,5
Connection mains	mm <sup>2</sup>	5x6	5x6	5x4	5x6	5x6	5x6	5x10	5x10	5x10	5x10
Intermediate fuse	Amp.	35	35	25	35	35	35	63	50	63	50
Air pressure	bar	6	6	6	6	6	6	6	6	6	6
Air vol. requirem. approx.	l/min.	2	2	4	4	4	4	6	6	6	6
Extraction outlet dia. D1	mm	180	180	180	180	180	180	180	180	180	180
Extraction outlet dia. D2	mm	-	-	180	180	180	180	180	180	180	180
Extraction outlet dia. D3	mm	-	-	-	-	-	-	180	180	180	180
Extraction perform. approx.	m <sup>3</sup> /h	1'800	1'800	3'000	3'600	3'600	4'000	5'400	5'400	5'400	5'400
Air speed	m/s	20	20	20	20	20	20	20	20	20	20
Length L1	mm	800	800	1'010	1'010	1'010	1'010	1'300	1'510	1'300	1'510
Length L2	mm	1'450	1'450	1'660	1'660	1'660	1'660	1'970	2'230	1'970	2'230
Width B1	mm	1'200	1'450	800	1'200	1'450	1'740	1'200	1'200	1'450	1'450
Width B2	mm	1'550	1'800	1'150	1'550	1'800	2'090	1'550	1'550	1'800	1'800
Height H min.	mm	1'740	1'740	1'860	1'860	1'860	1'860	1'860	1'860	1'860	1'860
Height H max.	mm	1'900	1'900	2'020	2'020	2'020	2'020	2'020	2'020	2'020	2'020
Net weight approx.	kg	2'300	2'400	2'300	3'000	3'200	4'000	3'500	3'700	3'700	3'700
Noise emission/idle running	dB	74	74	78	78	78	78	82	82	82	82
Noise emission/sanding	dB	74	74	77	77	77	77	82	83	82	83
CE Standard		yes	yes	yes	yes	yes	yes	yes	yes	yes	yes

Subject to change without prior notice

### Switzerland

KÜNDIG AG  
Hofstrasse 95  
CH-8620 Wetzikon  
Phone 01/932 37 57  
Fax 01/932 42 86  
e-mail: kundig@active.ch

### UK

Kündig Ltd.  
31, Churchill Close, Flackwell Heath,  
High Wycombe, Bucks HP 10 9LA  
Phone 01628 522625  
Fax 01628 532827

### France

Kündig Sàrl  
Le Gardot  
F-25500 Montlebon  
Phone 03 81 67 42 64  
Fax 0041 32 936 11 59

### Germany

KÜNDIG GmbH  
Kindleber Straße 168  
D-99867 Gotha  
Phone 0 36 21/87 86-0  
Fax 0 36 21/87 86-17  
e-mail: kundiggth@t-online.de

Homepage <http://www.kundig.com>