

MORREB

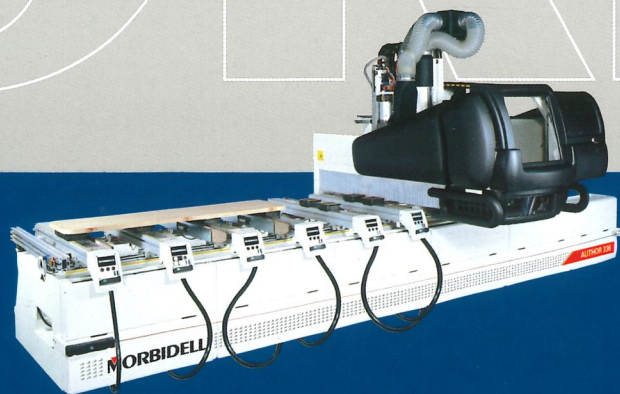

Numerically controlled
machining centres

Author 300

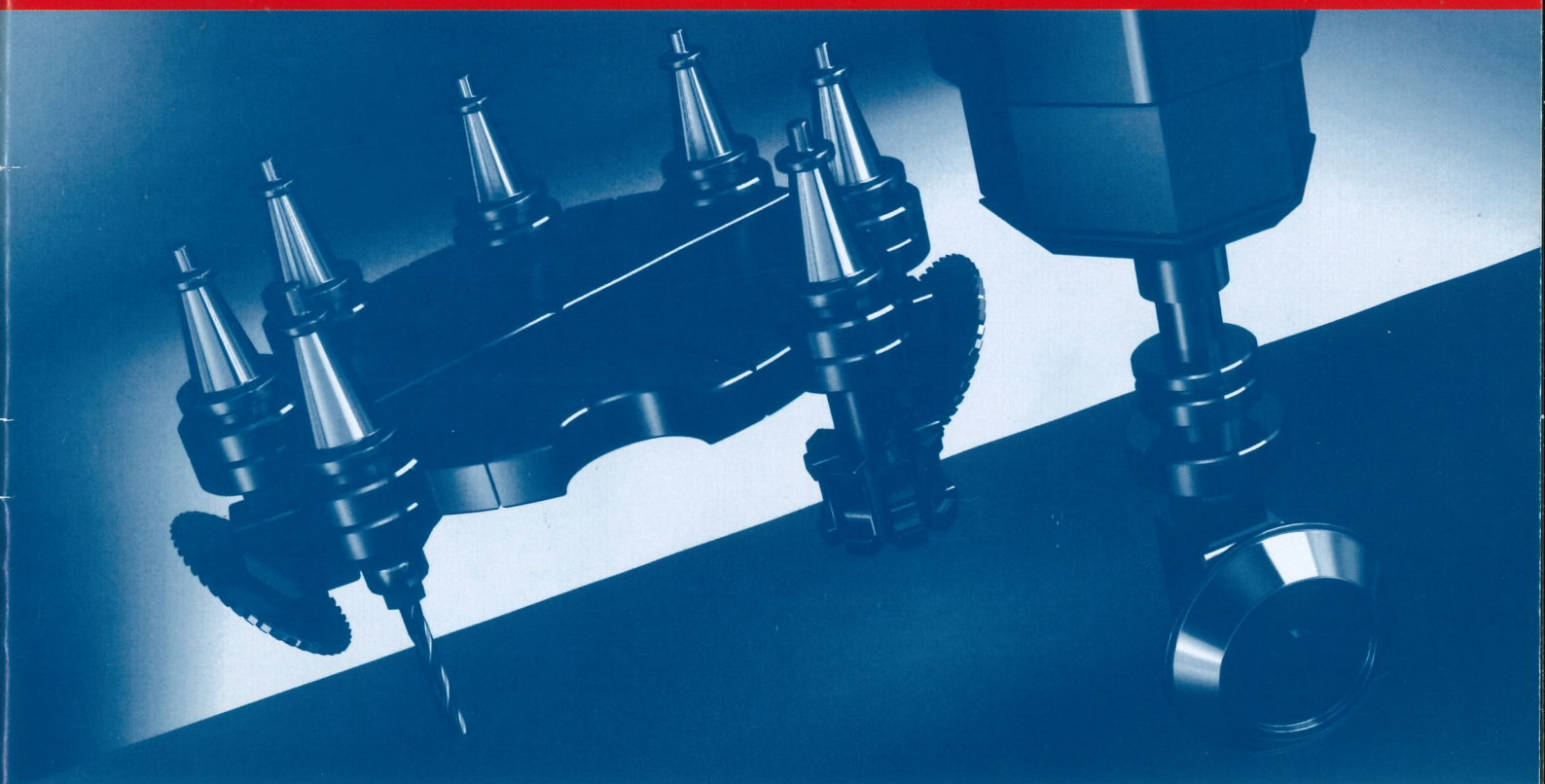

MORBIDELLI

Looking for these results...

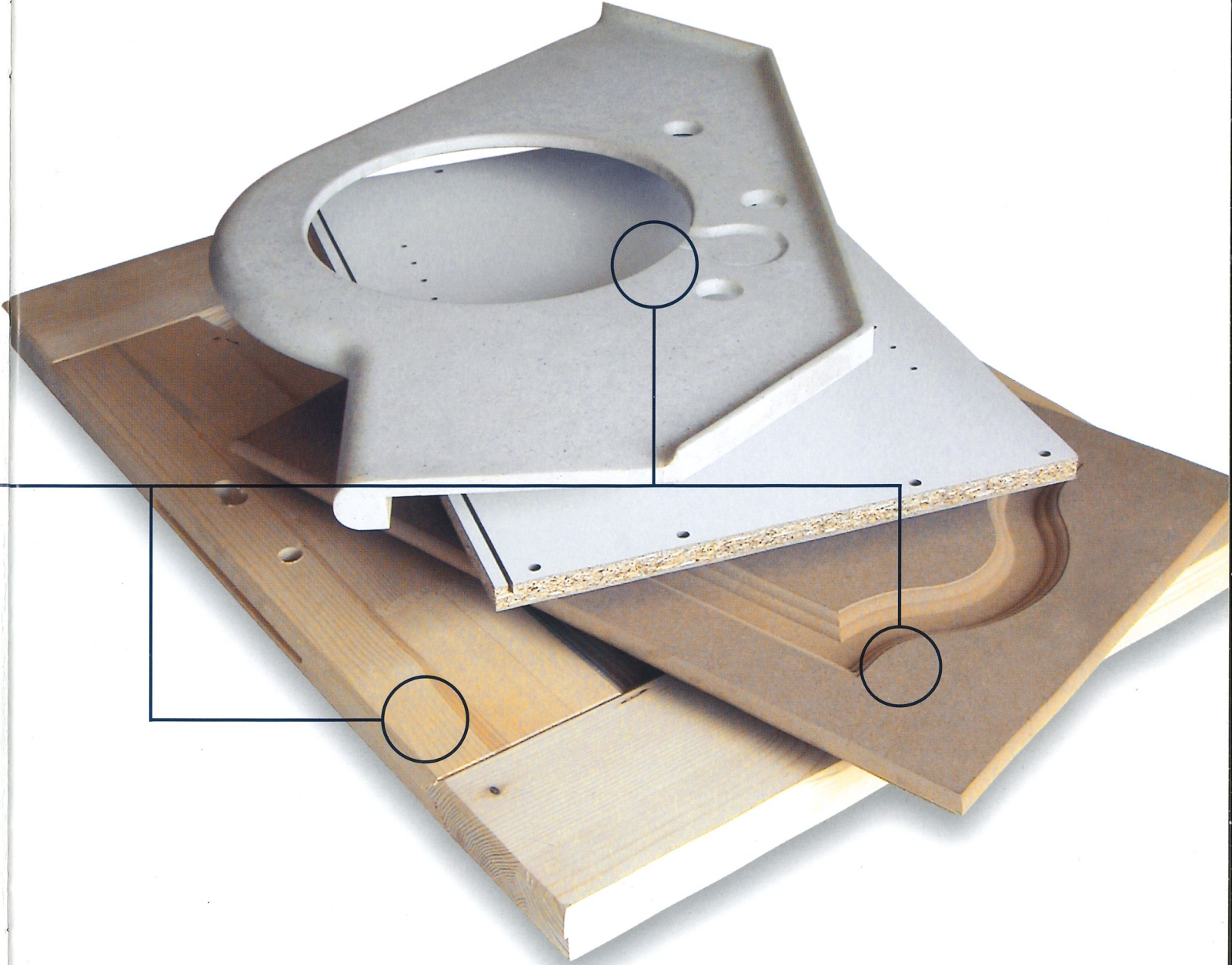

...this is the latest technology with
a reduced investment

A giant: to get into "CNC"
world with the whole
Morbidelli's technology

Author

327 · 330 · 336 · 344

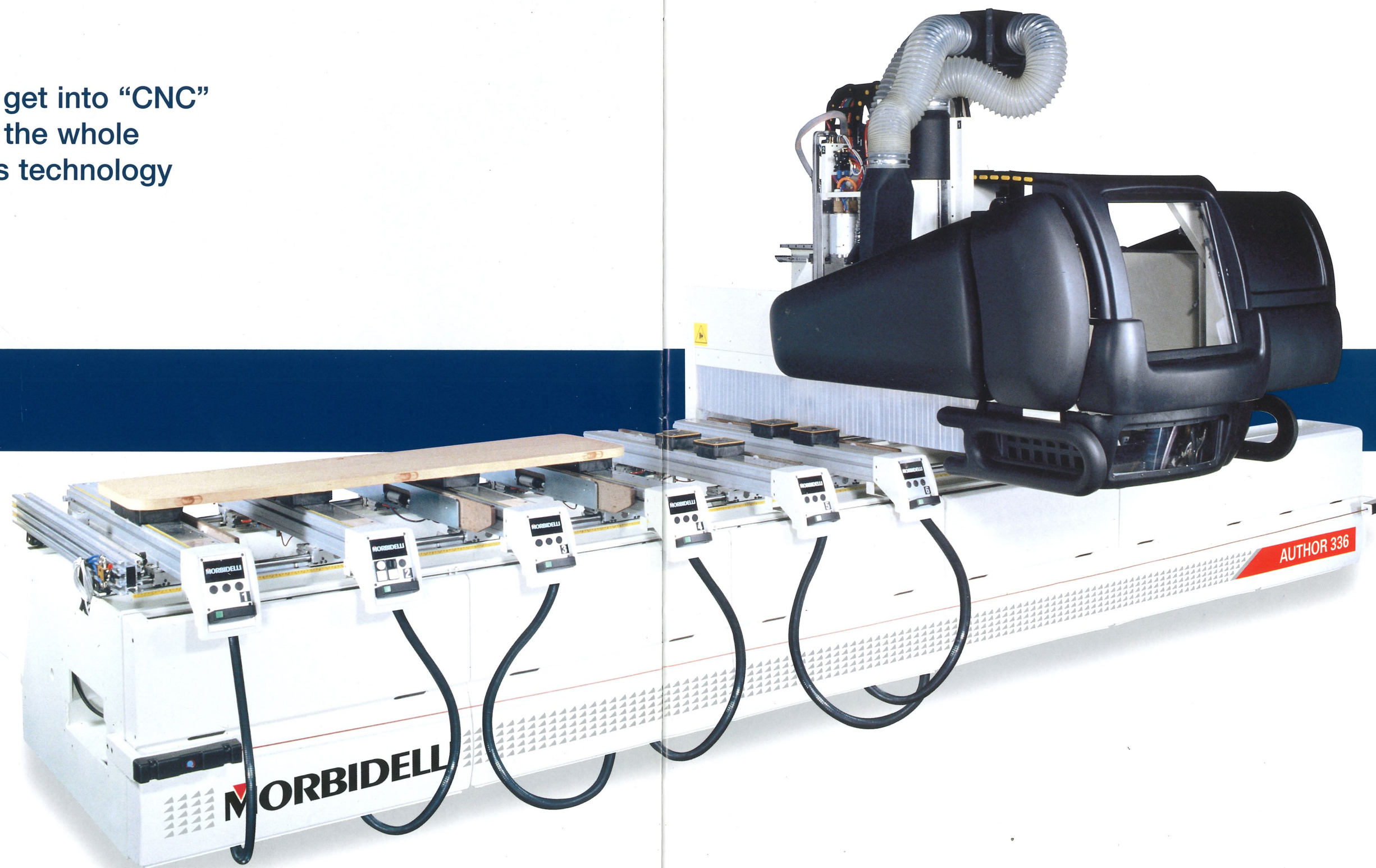

The best solution to execute Nesting working

Author

327 · 330 · 336 NB

A giant: "Nesting" workings with all the great advantages of Morbidelli's experience and technology.



For a superior rigidity and balance

The structure is designed to guarantee maximum strength and to balance dynamic loads, giving high precision machining, both for boring and routing.

The self-supporting steel base with a triangular cross-section is **a solid and balanced support** for the machine's moving parts. The strengthening ribs and the large supporting base are designed and built to guarantee lasting machine stability and precision, under any working conditions.

The **mobile machining unit** consists of **a single-piece unit with one beam**. Its parts are **electric arc-welded**, for maximum **torsion rigidity year after year**.

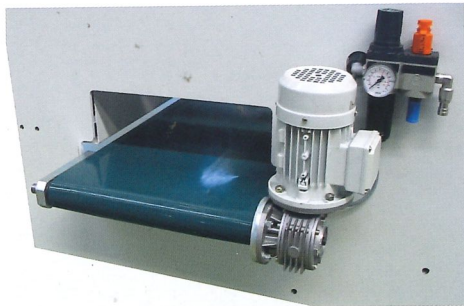

Dust extraction conveyor

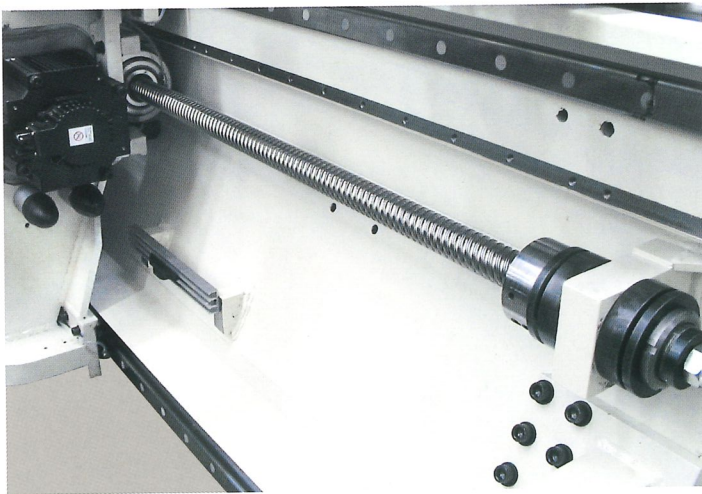
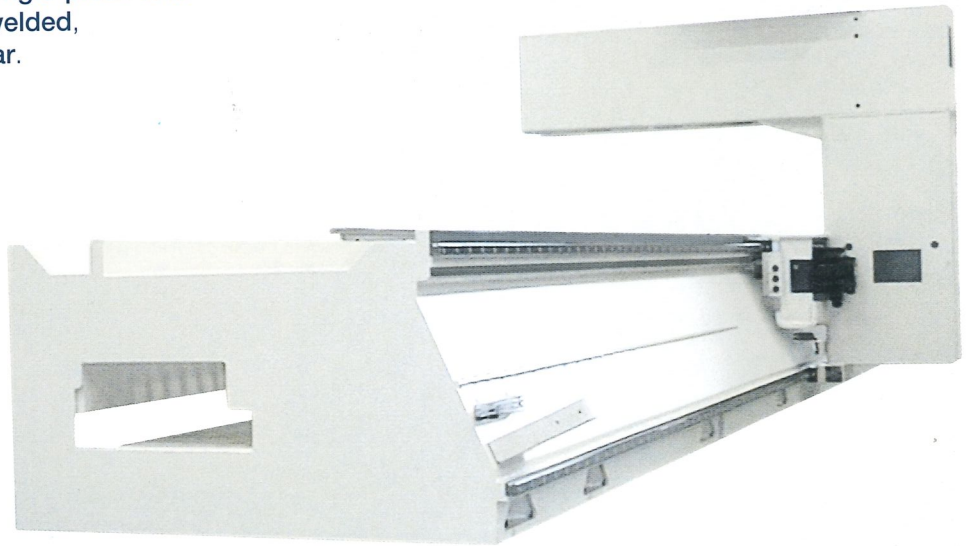

X, Y and Z-axis movements are driven by Brushless motors on recirculating ball screws, allowing **acceleration and deceleration of up to 5 m/sec²** with absolute positioning precision. The axes movement does not require a particular maintenance, this because it can be lubricated automatically without any operator intervention.

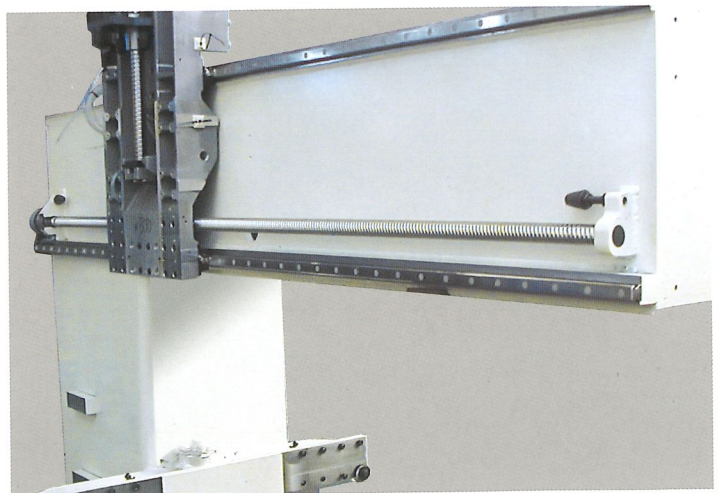

The mobile units run on **ground prism guides**, offset relative to their vertical axis to allow equal balancing of loads during machining.

For an equipping with high performances
and fully equipped

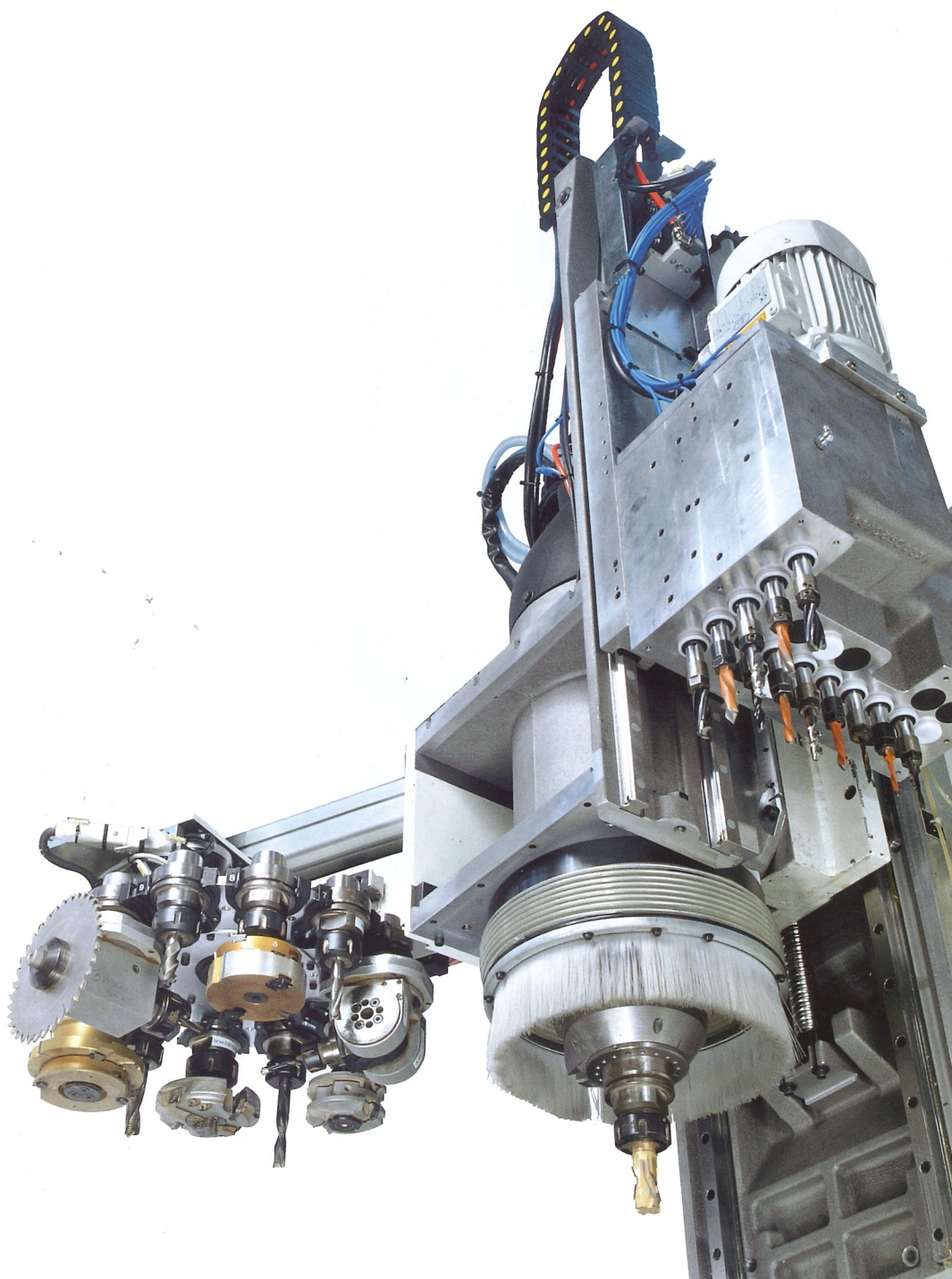

The electro-spindle, the boring head and all the optional units fitting Morbidelli's machines run vertically on **two prismatic guides at right distance** between them, in order to assure **precision, stability and rigidity** in any work condition.



- Electrospindle **HSK63** attachment available in three versions:
 - **6,6 KW S1 working** (7,5 KW in S6) 1.500÷24.000 rpm
 - **7,5 KW S1 working** (9,0 KW in S6) 1.500÷18.000 rpm
 - **11,0 KW S1 working** (13,0 KW in S6) 1.500÷18.000 rpm liquid cooled
- Drilling head with **7 or 12 vertical spindles**
- Tool Room up to **12 tools on board head**, for quick and exact change of the tools necessary to execute any working.



For speed drillings with accurate and high quality...



Drilling head with **7 vertical spindles** able to satisfy any drilling requirement.



All of the boring units on Morbidelli machining centres are made with the new (Patented) integral bearings and can reach speeds of rotation up to 6000 rpm.

This solution provides:

- Higher Z-axis feed speed
- Reduced machining time on panels
- Improved hole quality
- there are no problems with shavings extraction. The extractor system is built into the structure of the head and removes sawdust at the point closest to where it is produced. The result is an improved work piece finish.

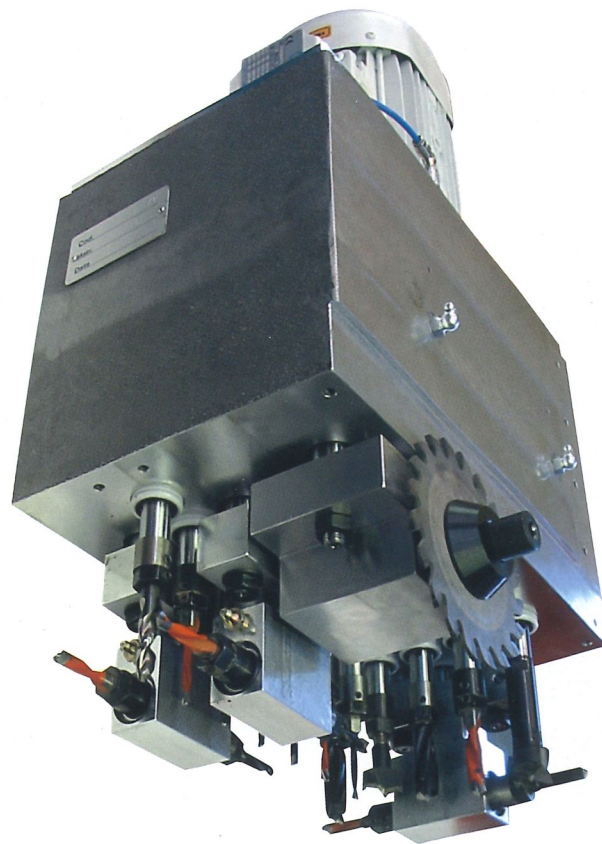
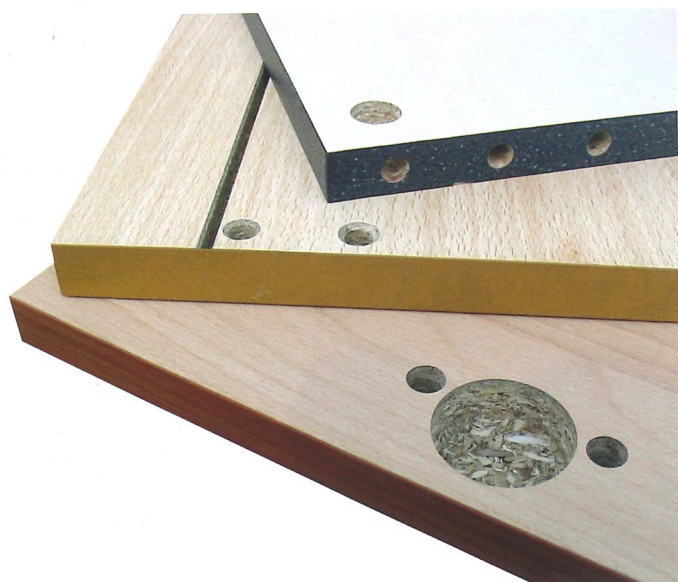

Drilling head with **12 vertical spindles 6 horizontal spindles and integrated saw blade** for cuts and grooves; the right solution to meet the different requirements of the customer.

To choose powerful and reliable units

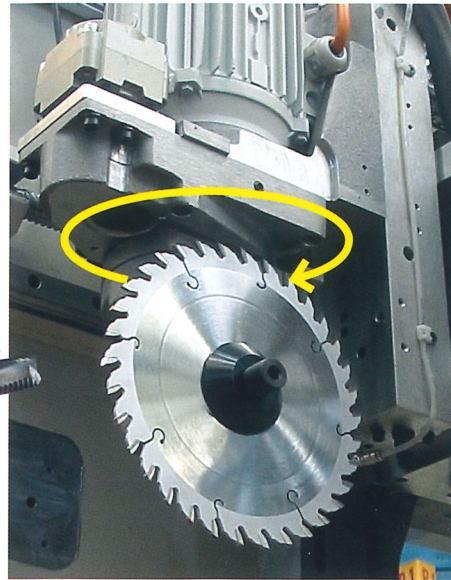
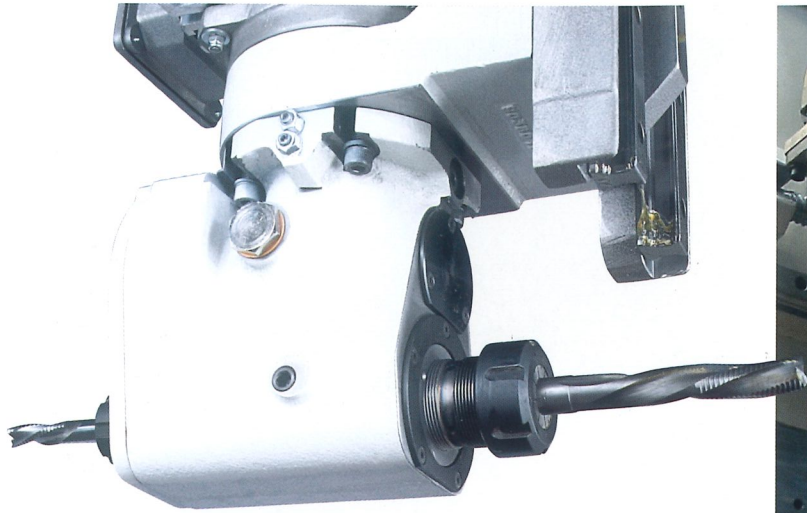

Each particular machining can always be satisfied utilising dedicated units as:

- The horizontal routing with 3 KW and speed rotation 6.000÷18.000rpm managed by inverter permits door locks and shelf holding recesses operations to be carried with complete reliability.
- The independent disc saw unit allows to lock pieces to be end trimmed and any type of panel to be squared, with automatic rotation of the blade from 0° to 90° managed by numerical control.



VECTOR, 0/360° numerically controlled rotating continuous axis, to execute, transversal and inclined borings and in respect of the panel's surface, utilising angular head. It can make without any problem also **interpolating routing operations** thanks to its body with **mechanical displacement extremely rigid and exact**.

For a simple and immediately programmable numeric control

Morbidelli machining centres are equipped with an innovative numeric control, with a Personal Computer as operator interface.



The main functions of the machine.

This solution guarantees the operator an **incomparable level of user-friendliness and comfort, making work much easier**. Morbidelli software operates in a **Windows environment for simple, effective programming**.

The software design takes into account programmer requirements, to cater for both expert operators and machining centre first time users.

The **graphical aids** allow intuitive programming, without extensive computer skills. Yet even those with more confidence will find something familiar in it, not requiring extra effort to take in new systems and will immediately be able to appreciate its great potential.

Main hardware features

- Intel processor (2.4 GHz or above);
- 15/17" colour monitor;
- Keyboard and mouse;
- 40 Gb (or above) hard disk;
- 3"1/2 floppy disk drive (1,44 Mb);
- CD ROM (48x);
- 256 Mb RAM memory (or above);
- 2 serial ports, 1 parallel port, 4 USB ports (to connect to any type of peripheral: bar code reader, modem, printer, scanner etc...);
- Network card (opt.), sound card.

Author 300

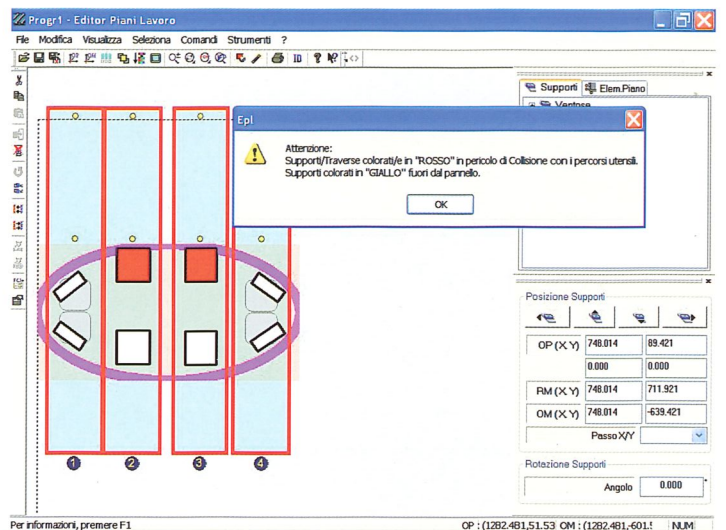
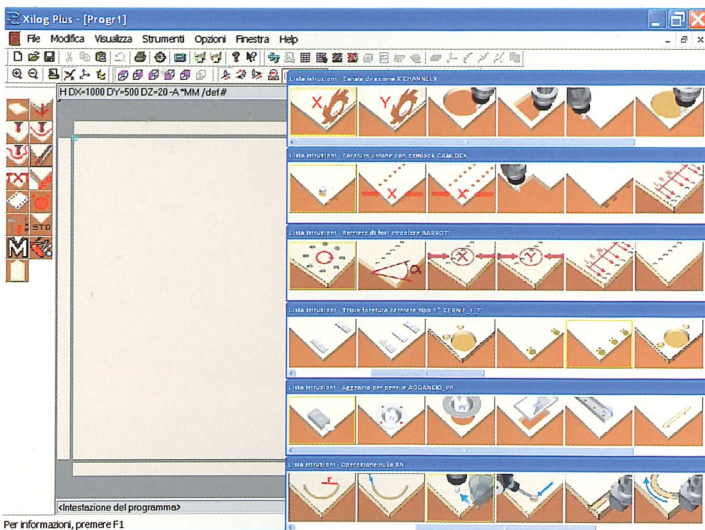
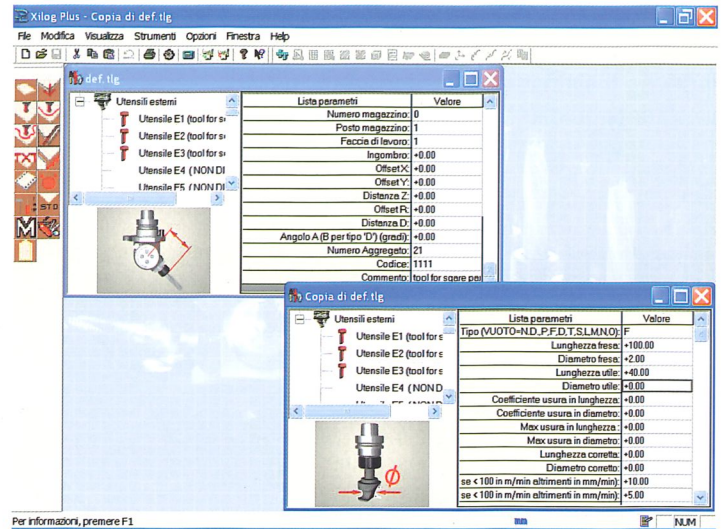
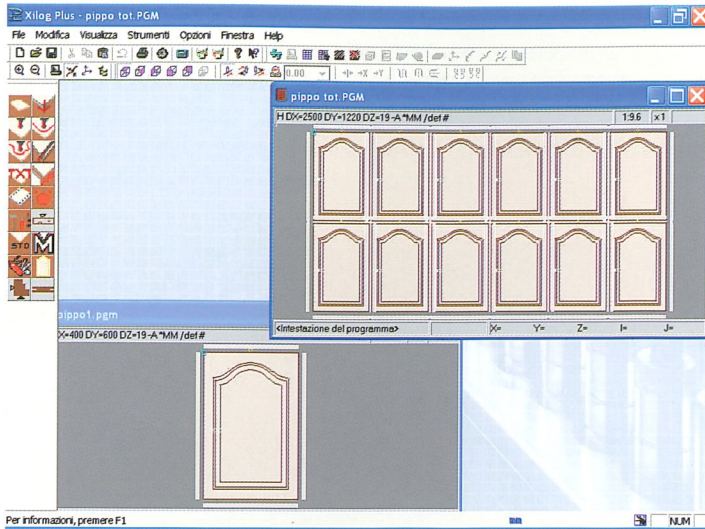

Main software features

- Windows operating system with functions such as: copy, paste, edit, clear, properties, curtain menu, right click on the mouse for quick menu, multiple opening of windows etc.
- Equipping management with **tool visualisation** and with graphic supports to avoid the possibility of data input errors;
- **Immediate and direct uploads** of DXF format files;
- **Optimised dynamic drilling; graphic and syntactic aids** or drilling and milling operations to speed up data input operations;
- **Graphic visualisation of the manufactured piece** to allow for a quick and efficient check of the programme results;
- **Parametric programming**, to automatically update the programme when the sizes of the manufactured piece change, thus avoiding having to write a new programme;

- **Macro creation in a few minutes**, by using parametric programming;
- **Creation of programme blocks** that can be inserted inside other programmes;
- **Self diagnosis and warning of any errors** or possible failures through alarm messages in the user's language that aid quick understanding;
- **Graphic aids for the positioning of work supports** to avoid collisions with the tools in cases of passing drilling and/or milling to eliminate the empirical trials directly on the machine;
- **Execution of programmes through bar codes.**

For a fast worktable set-up

This type of table has **aluminium supports** without any tubes and pneumatic connections, which could obstruct suction cut positioning. The **pneumatic locking system** of the suction cups permits to load and unload the panels with complete **safety**, avoiding during these operations accidental displacements of the suction cups that can cause during passing working their damages. A **sensor device** controls the hold-down of the suction cups, and **set up the execution** of the programs only if there is a **correct functioning** of the device.

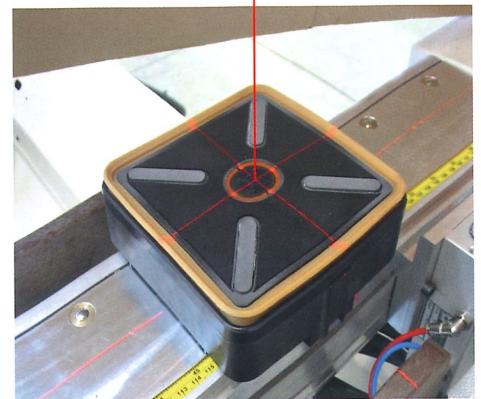
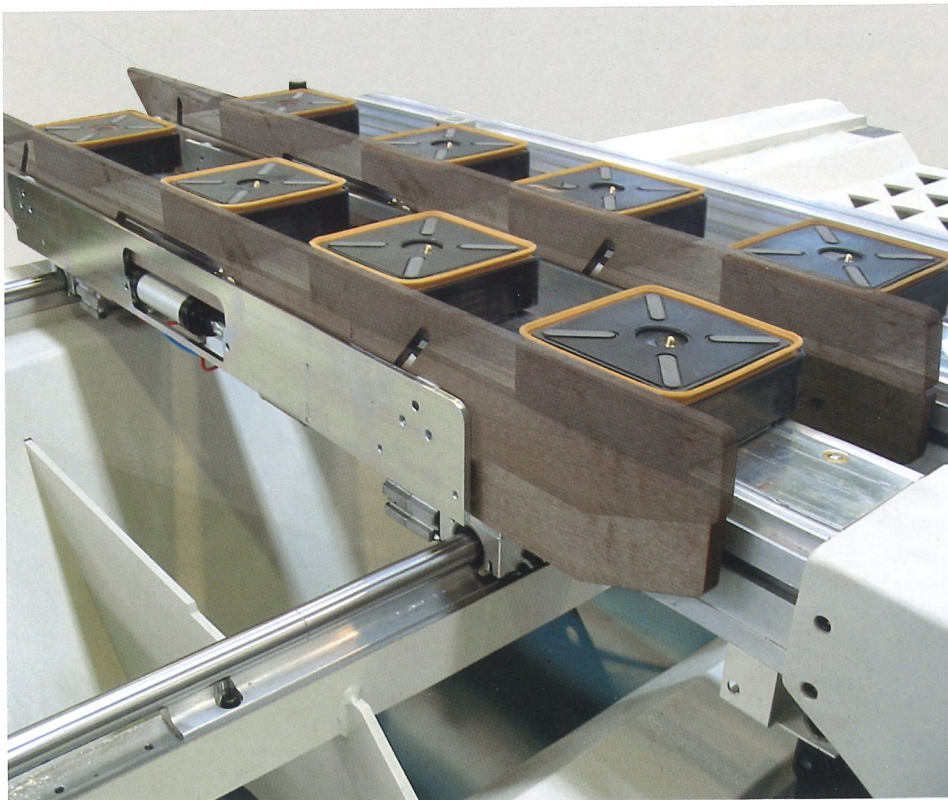

Author 300

The suction cups, of different sizes, can be released from the individual supports and can be managed relative to the panel dimensions so as to concentrate the vacuum only where it's necessary, increasing work piece hold-down efficiency. The lifting devices ease the loading/unloading operations of the working area and are particularly recommended for heavy and big panels. Laser devices installed on the mobile support of the machine allowing to visualise the exact positioning in which the suction cup has to be placed. This device is very fast and at error-proof as any reading or interpretation of the operator it's not necessary. Dedicated Systems, are available for holding-down special work pines as frames, uprights, etc.

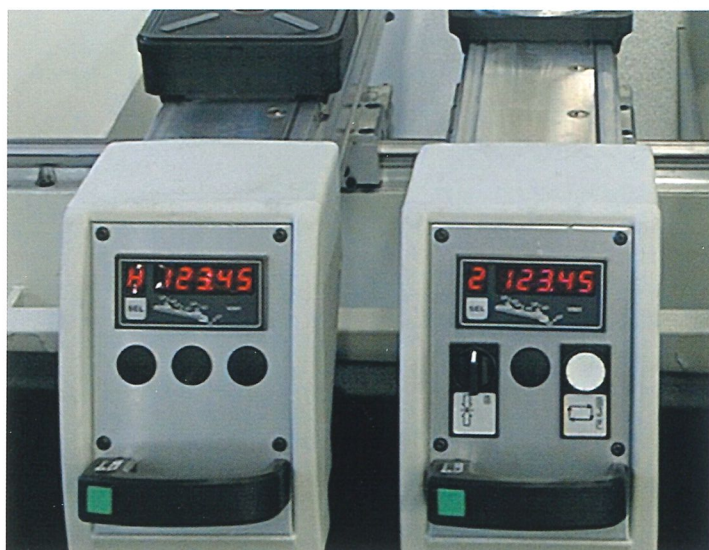
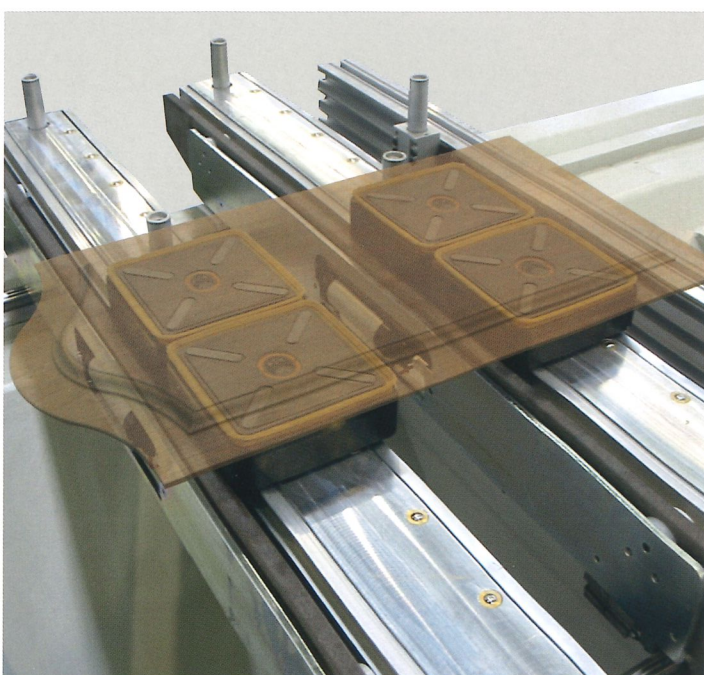

To produce optimising time and space

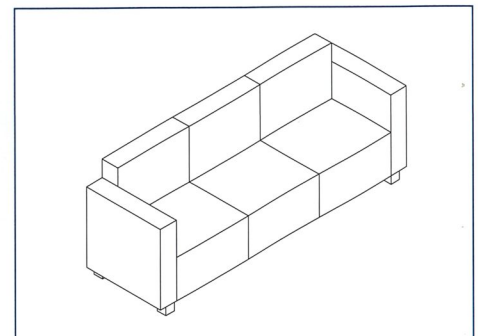
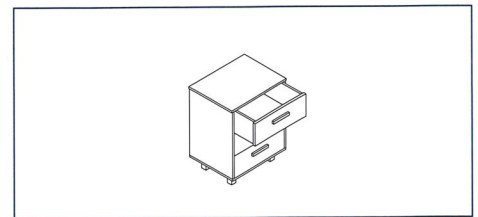
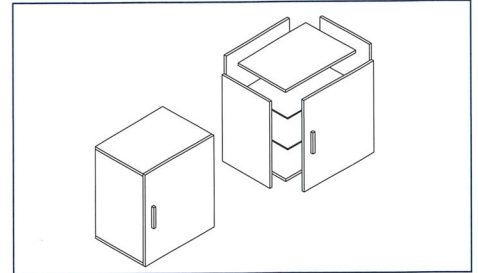

Nesting Based Manufacturing

The aluminium working table with vacuum locking allows a “nesting” processing and the production of all the pieces for a specific manufacture article (kitchen, wardrobe, desk or other) by optimising the use of one or more material papers as MDF, chipboard, multiplayer and so on.



Advantages

- **Reduction of the rejected materials.**
- **Drastic lowering of the “Time to Market”** due to the possibility to work on a single work order.
- **Production of single pieces considerably shorter.**
- **Increase of quality of the finished product** because of the less manipulation of pieces and thanks to the use of only a single machine.
- **Reduction of the stock of work in progress parts;** you produce only what it is sold. An almost completely automated solution and, so, with **reduction of labour use.** Reduction of machinery, which intervenes in the production run with consequent reduction of investments in equipment and of the impact of, **fixed costs.**

Author 300



A wide series of locking system is able to assure to the continuous aluminium-working table an incomparable flexibility.

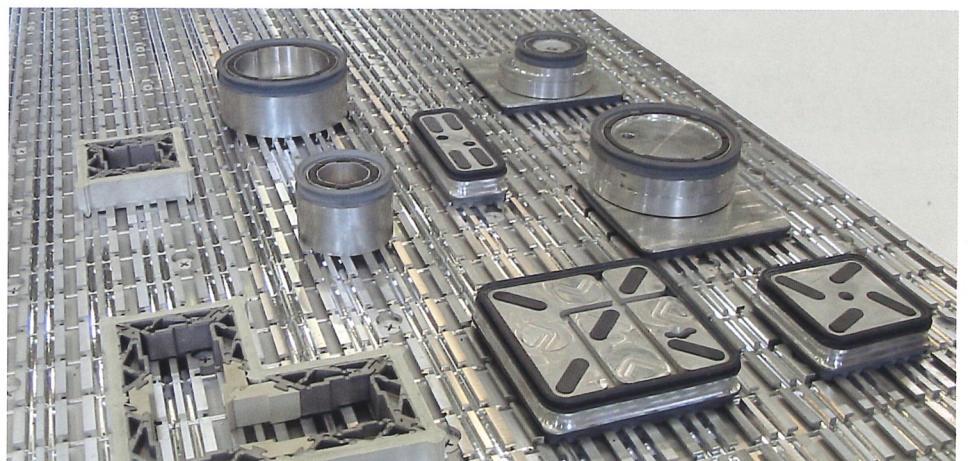

The side pusher is designed for an easy and automatic handling of finished pieces out of the machine. This device is directly mounted on mobile beam and it pushes the finished pieces on a support surface on the right end of the machine. It also cleans and clears the working area for next processing, thanks to a suction device. The operator can arrange the finished pieces without losing time, while the machine continues its working schedule.



For an innovative and practical
CE safety system...



Sensitive mats or photocell barriers

These solutions immediately stop the machining cycle if the operator enters the machine operating area. This so-called "active" safety system prevents any contact between the machine moving parts and the operator.

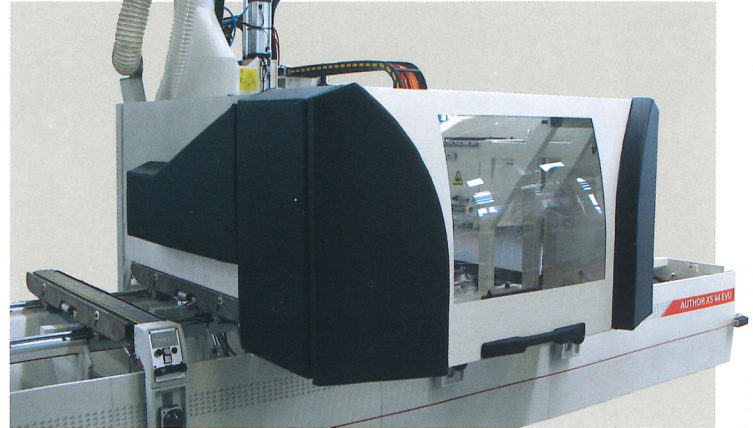

Bumpers

This system has bumpers fitted around the mobile upright, with sensors that immediately stop the machine if there is any contact with obstacles. **Operator safety is always safeguarded**, since any contact is dampened by the absorbent material used to make the bumpers and by the machine stopping immediately within just a few centimetres.

The advantages of this system are:

- **Machine use at its maximum production capacity**, without unwanted interruptions in the production cycle;
- Possibility of **pendulum machining on larger panels**, with the same X-axis machining range, compared with the solution with mats.

Overall dimensions

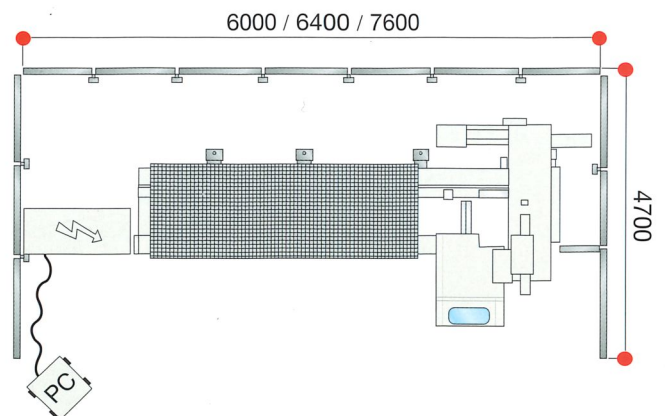
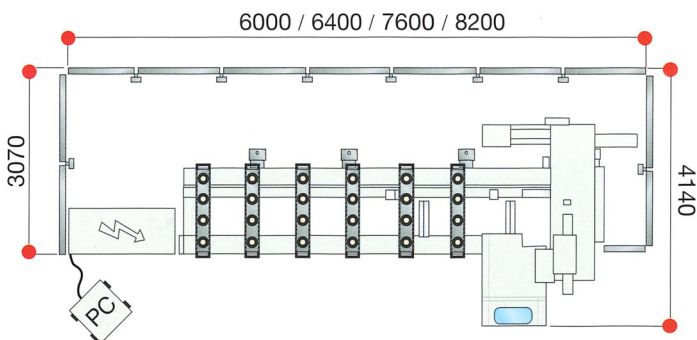

In this catalogue, machines are shown with options. The firm reserves the right to modify technical specifications without prior notice, provided that such modifications do not affect safety as per E.C. certification.

Technical data



Author 327-330-336-344

Speed movement X axis	m/min	40/50/80
Speed movement Y axis	m/min	45
Speed movement Z axis	m/min	23
Electro-spindle power (S1)	KW	6,6/7,5/11
Tools available on Rapid		12
N. vertical spindles		7/12
N. horizontal spindles		0/6
Max Diameter saw blade		120
Panel passage	mm	180
Z axis stroke	mm	280
Installed power	KW	20÷30
Weight	kg	2900÷4800

Author 327-330-336 NB

Speed movement X axis	m/min	40/50/80
Speed movement Y axis	m/min	45
Speed movement Z axis	m/min	23
Electro-spindle power (S1)	KW	6,6/7,5/11
Tools available on Rapid		12
N. Vertical spindles		7/12
N. horizontal spindles		0/6
Max Diameter saw blade		120
Panel passage	mm	180
Z axis stroke	mm	280
Installed power	KW	20÷30
Weight	kg	2900÷4000

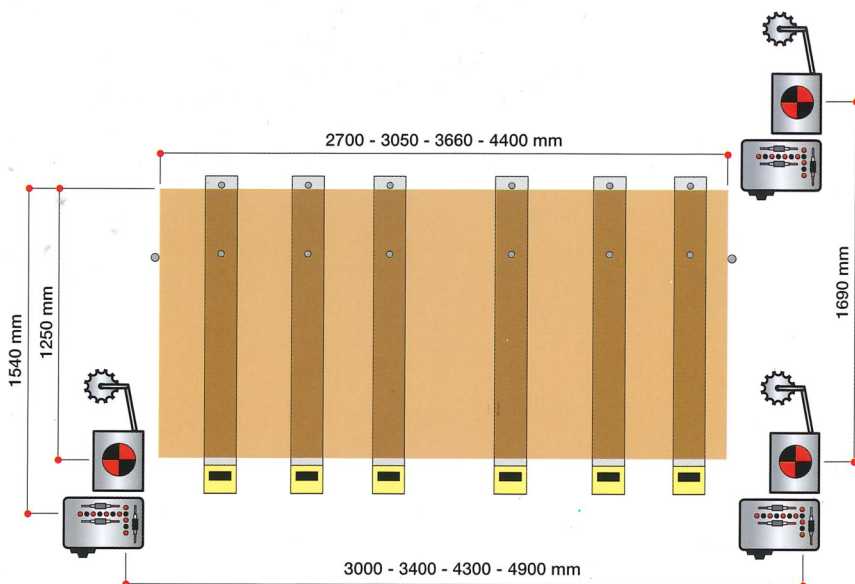

Layout

327 - 330 - 336 - 344

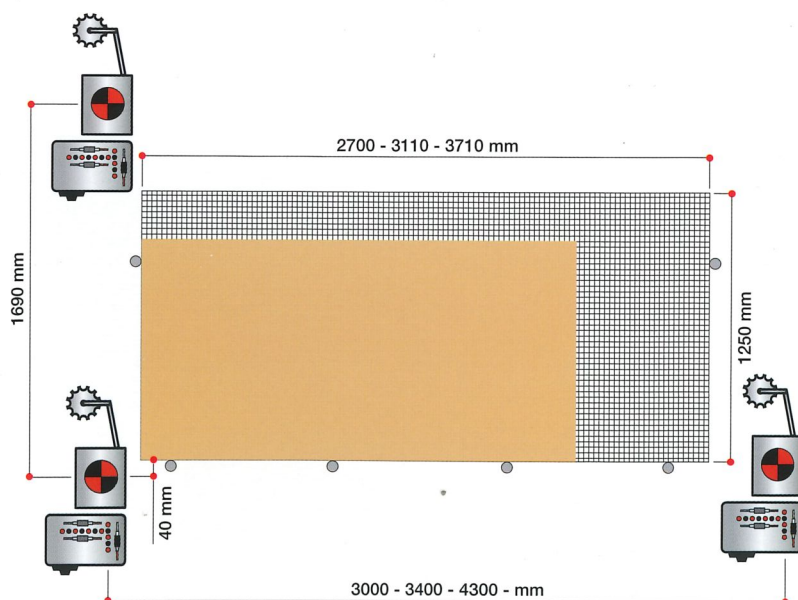

Layout

327 - 330 - 336 NB

SINCERT



MORBIDELLI

MORBIDELLI



MORBIDELLI

SCM GROUP spa - MORBIDELLI - Strada Montefeltro, 81/3 - 61100 Pesaro - Italia
Tel. +39/0721/4451 - Fax +39/0721/445264 - www.scmgroup.com - E-mail: morbidelli@scmgroup.com