

MORE

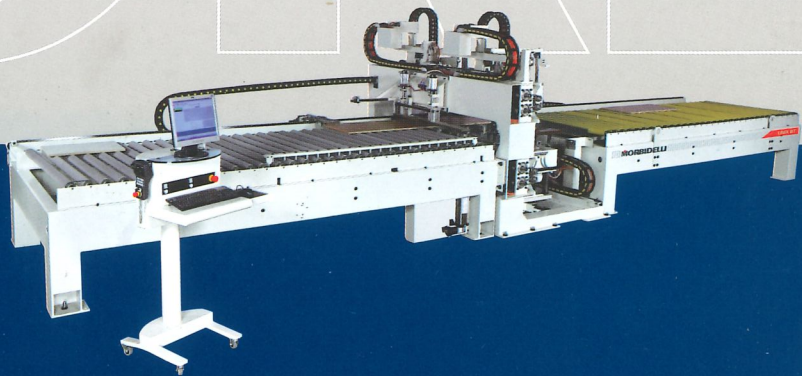

CNC Work center for flexible boring,
routing and hardware insertion

Unix BT·BTI·KBT

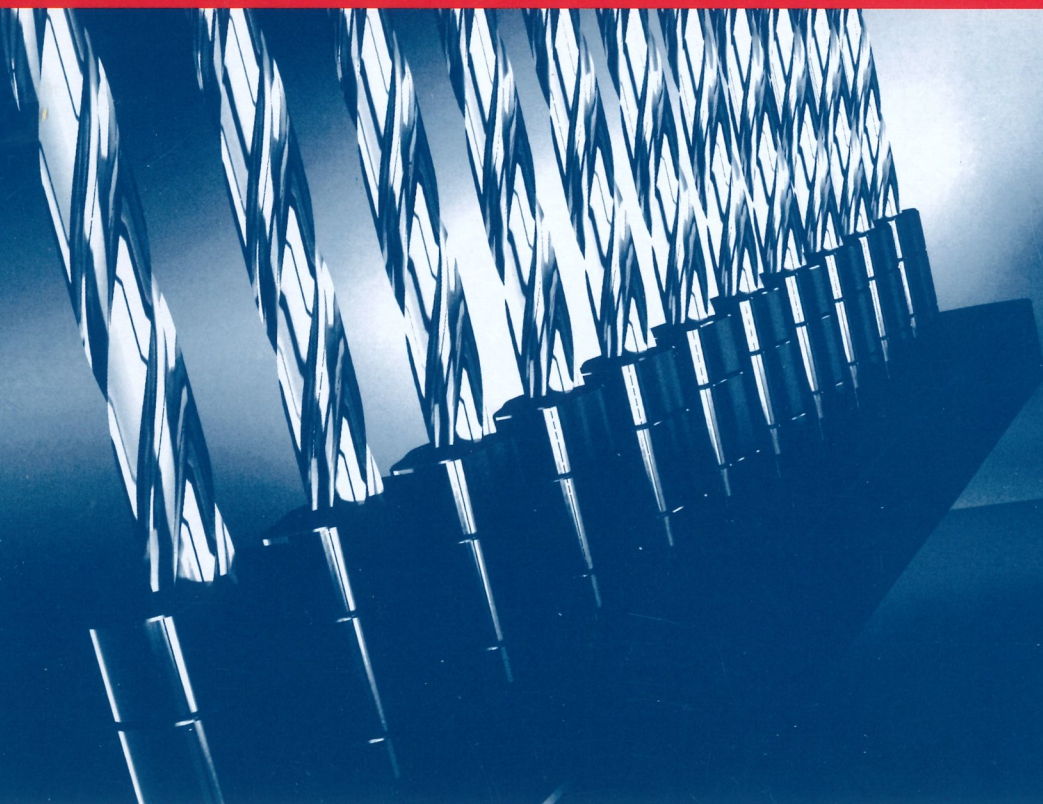

MORBIDELLI

if you're looking for these results...

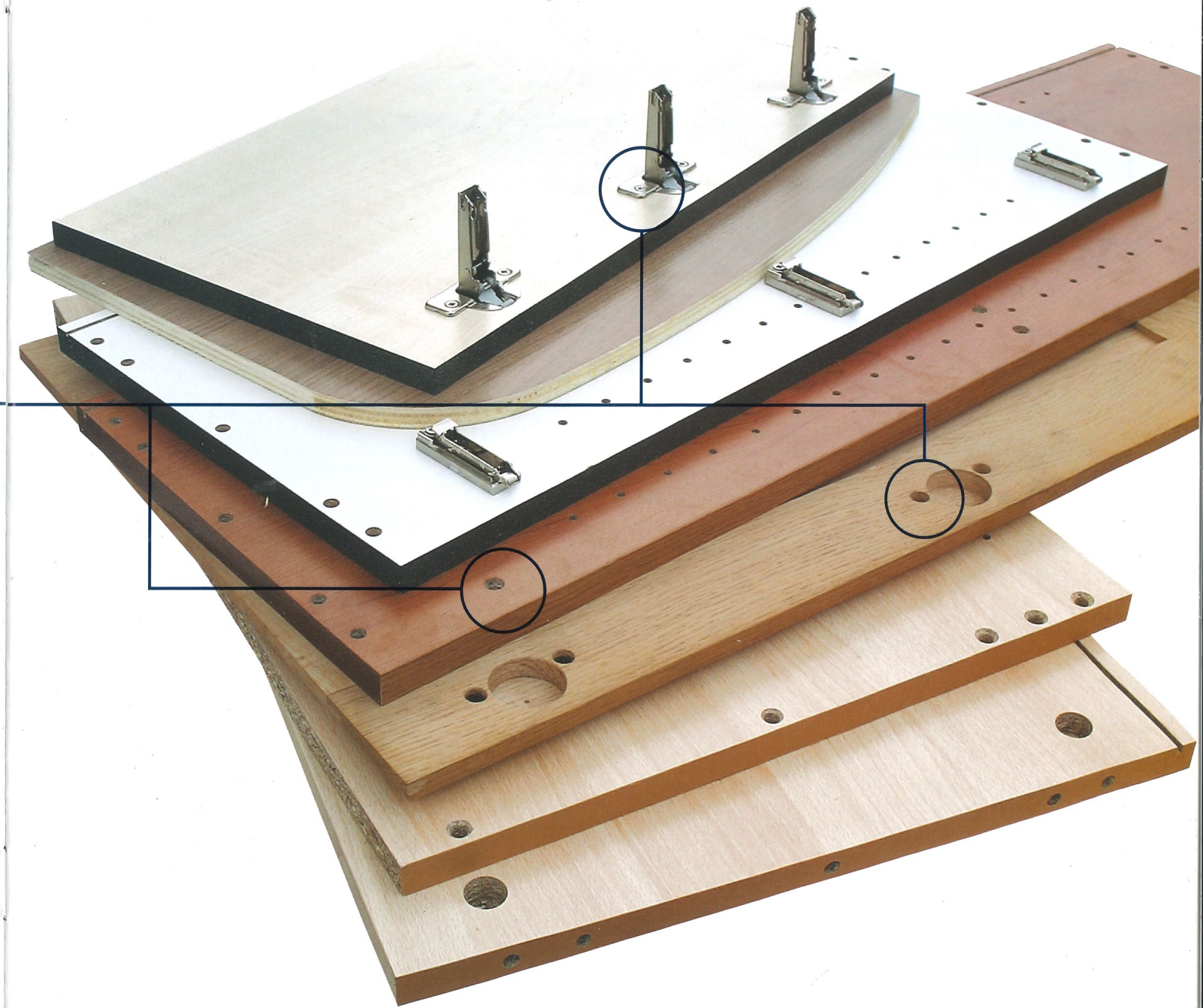

...this is the answer to all your custom needs

Unix

BT · BTI · KBT

Finally, the ideal solution for those who are looking for the maximum flexibility to work with no batches, guaranteeing high standard of quality and high production speed.

- Up to 104 independents spindles for highest boring capacity
- Time for set up = 0 sec.
- No problems with routing operations
- Hardware inserting with maximum flexibility
- Best working comfort for operator

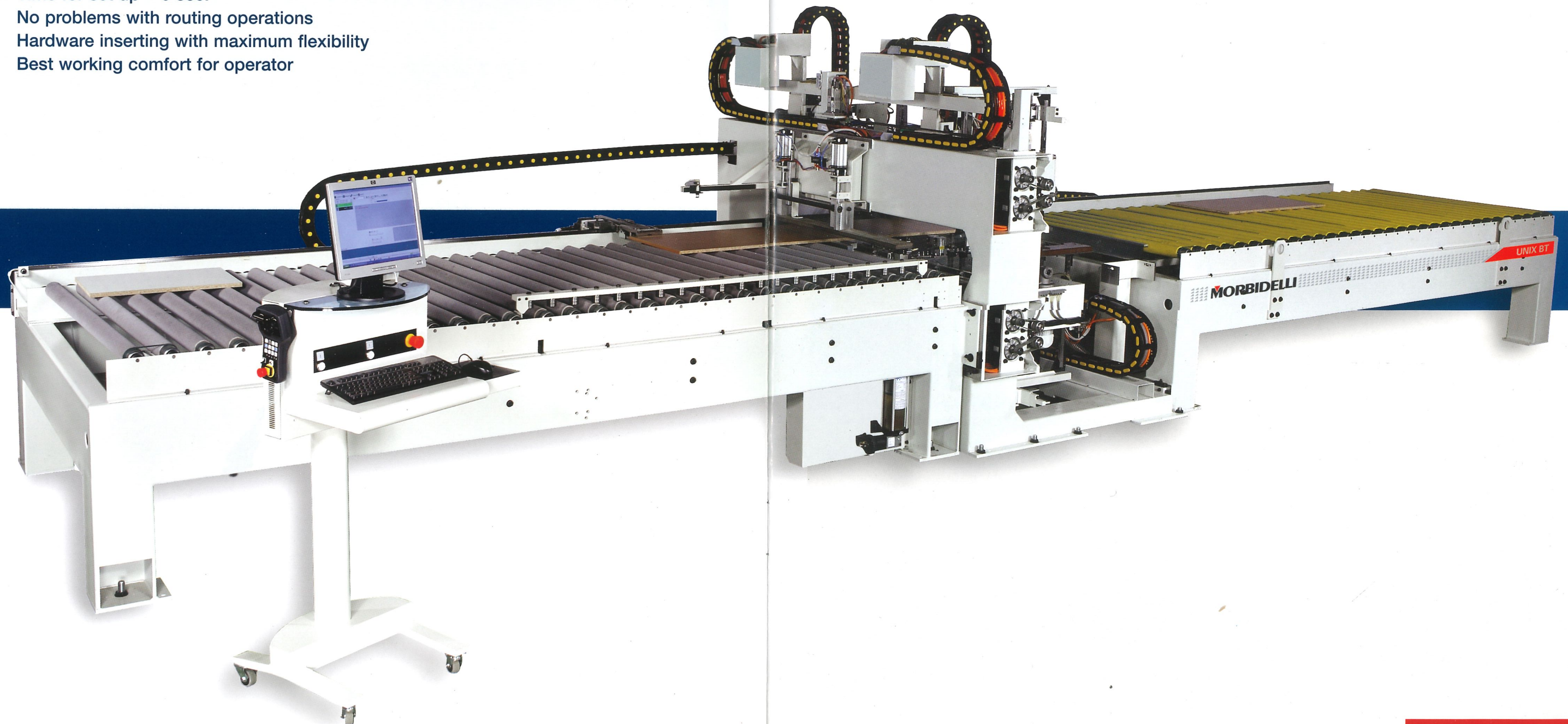

Structural rigidity is a must

The load bearing structure of UNIX is made of a **single-piece base** to ensure a **high structural rigidity** and a **total absence of vibrations**, with any configuration and **under the most severe machining conditions**, assuring the highest machining quality **during the time**.

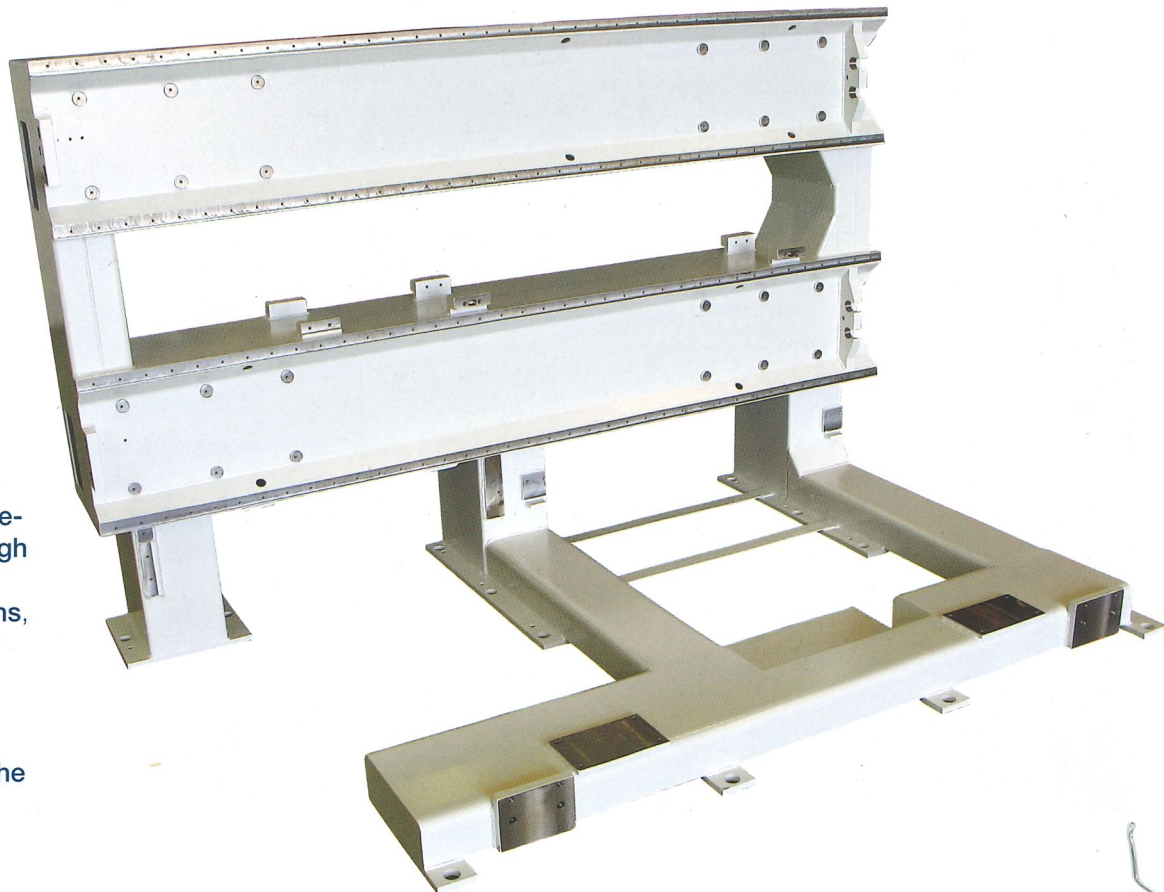

All the movement devices of the machines are installed on **recirculating ball screw slides** moving on **rectified prismatic guides** of big dimensions and positioned wide apart for a rigid support to ensure perfect balance of the static and dynamic loads.

The movement of the axes is driven by **high power and precision brushless motors**, that activate the movements devices as **<recirculating balls nut-screw>** and **<pinion-rack >** equipped with **devices for the automatic feedback of the slacks**. All of this to ensure the highest accelerations, **speed and quality production**.

To facilitate the usual maintenance operations, the lubrication of all the movement devices, is **centralised in very easy to reach locations** and it can be managed **automatically** by the numerical control of the machine.

If the boring quality is your priority

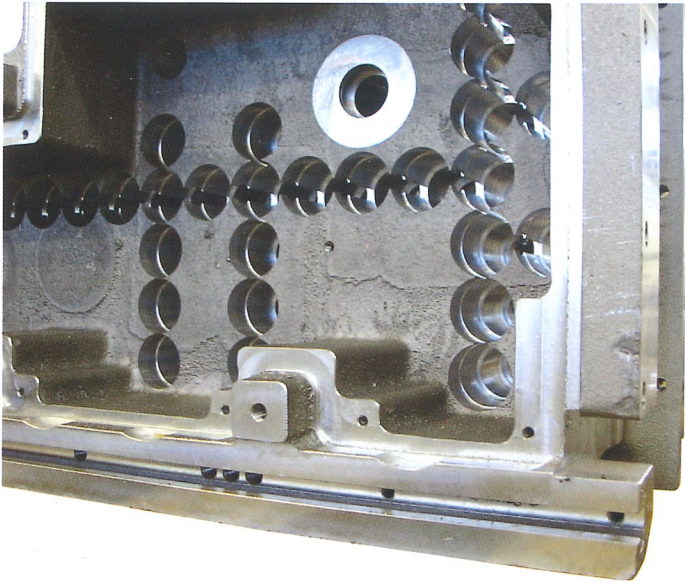

The boring heads are made of a **single aluminium alloy** for an **absolute boring precision ($\pm 0,1$ mm)**.

The independent spindles in **temperate steel**, moving **vertically inside the patented bearings**, can reach **6000 rpm** rotation speed.

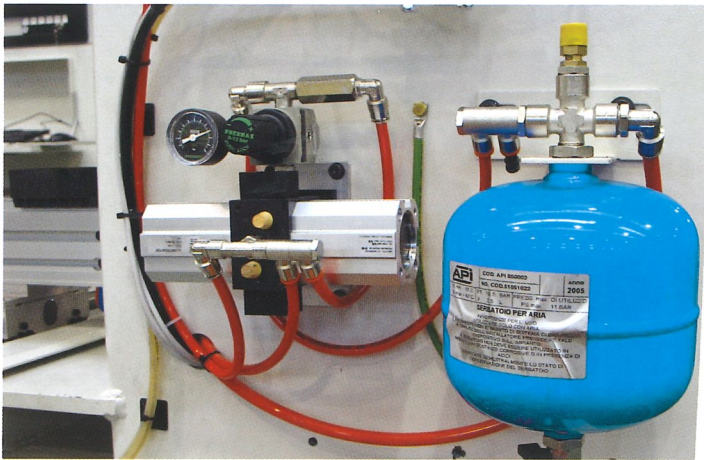

The pneumatic activation of each spindle is ensured by a **compressed air system at 9 BAR**, to make heavy workings also with **hard materials** as the plastic laminates.

These solutions are realised in:

- **higher speed of Z axis;**
- **Reduced working time on the panels;**
- **best boring quality.**

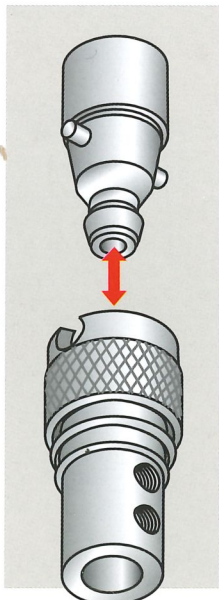
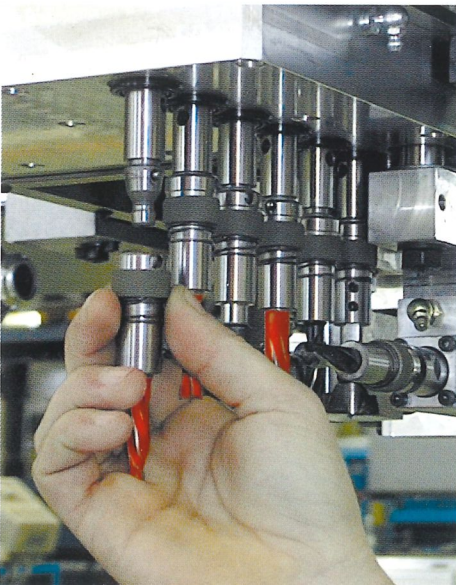

A patented system of **conical quick attachments** in temperate steel, allows the complete replacement of the bits in **few minutes**, in an easy **and precise way**, even after intense working shifts, with no need for waiting for the boring heads to cool down.

For a fast and reliable handling panel system

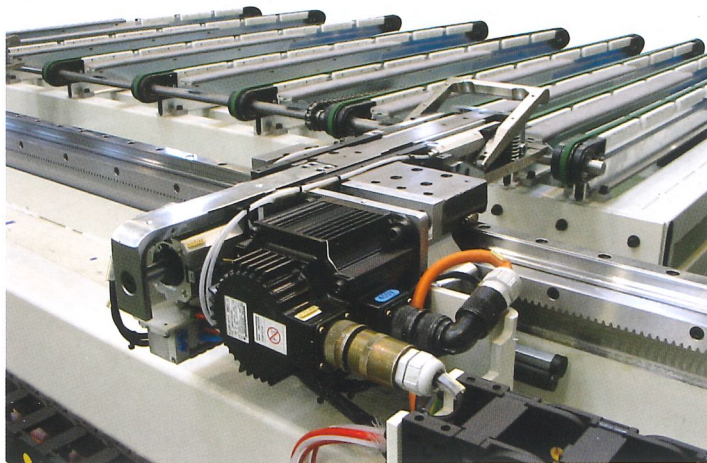

The displacement of the panel along the longitudinal axis of the machine is realised by a set of **independent clamps system (patent pending Morbidelli)** displaced by **brushless motors and managed by numerical control**. The clamps themselves also act as rear reference stop to align the panels. **The speed displacement over 100m/m** allows for a fast positioning and quick workings cycles

The clamps of the UNIX can **hold any kind of panel on both a straight or profiled edge** (doors etc.), in this way it is possible to choose on which side to reference the panel, so that possible errors due to the dimensional tolerances of the panel can be moved on the opposite side of the chosen reference.

The reduced dimension and the high clamping power of the UNIX's clamps allow for the clamping to be performed in any point of the panel, even with the clamps only partially holding the panel. The **numerical control automatically calculates** the proper clamping point of the panel and manages an eventual re-positioning of the clamps for panels with **complicated machining**; the operator only **has to program the panel to manufacture**, without any worry of collisions between the machine moving parts and the components to be produced.

It's possible to machine also big panels, up to 60 mm thickness.

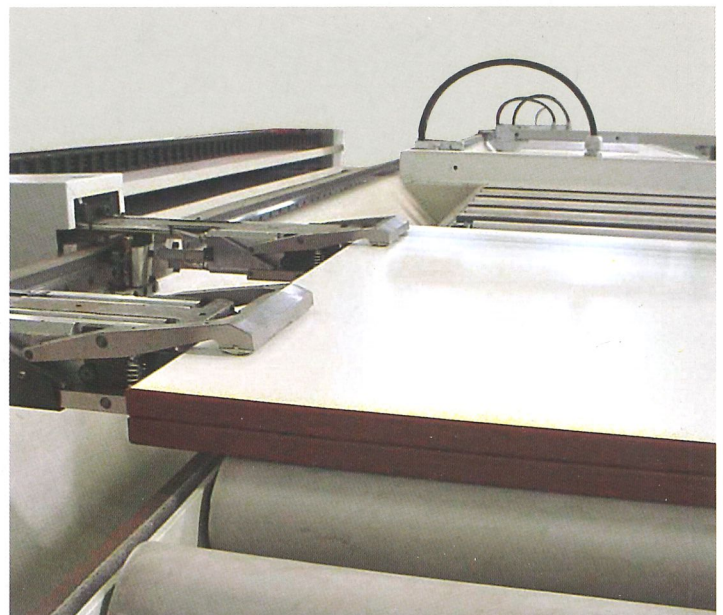
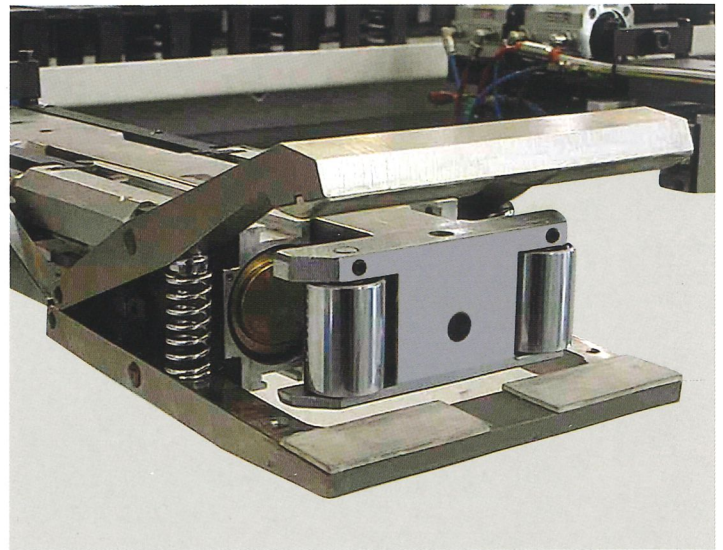

Unix BT·BTI·KBT

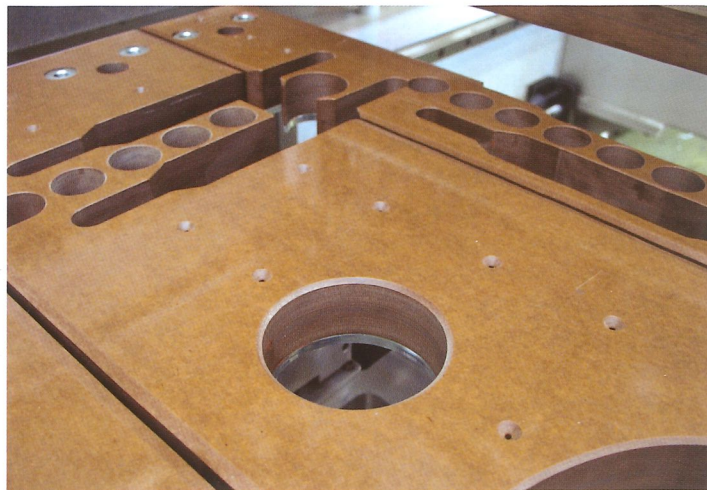
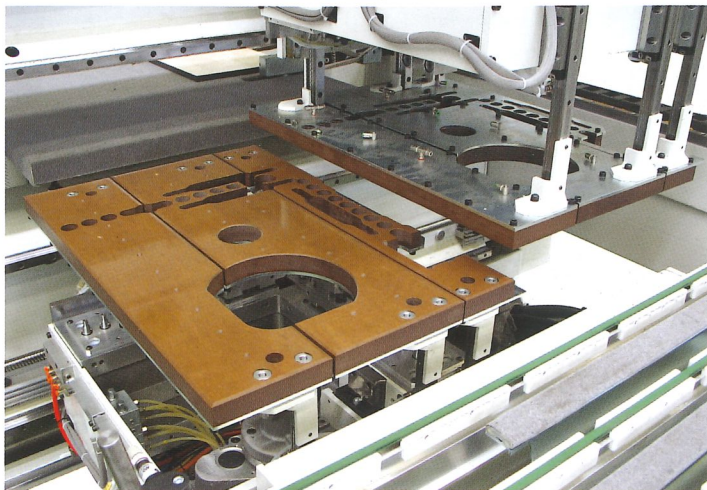

An adjustable to the thickness of the working panel air contrast table device assures a perfect machining on all kind of materials with any of the possible configuration of the UNIX.



The Unix can be equipped with integrated reading systems of the length and thickness of the feeding panel that allow to obtain in real time the dimensional features of each feeding panel.

This allows the automatic correction of the errors due to the dimensional tolerances of the panels. This allows for an enormous time saving during the assembling phase of the finished products.

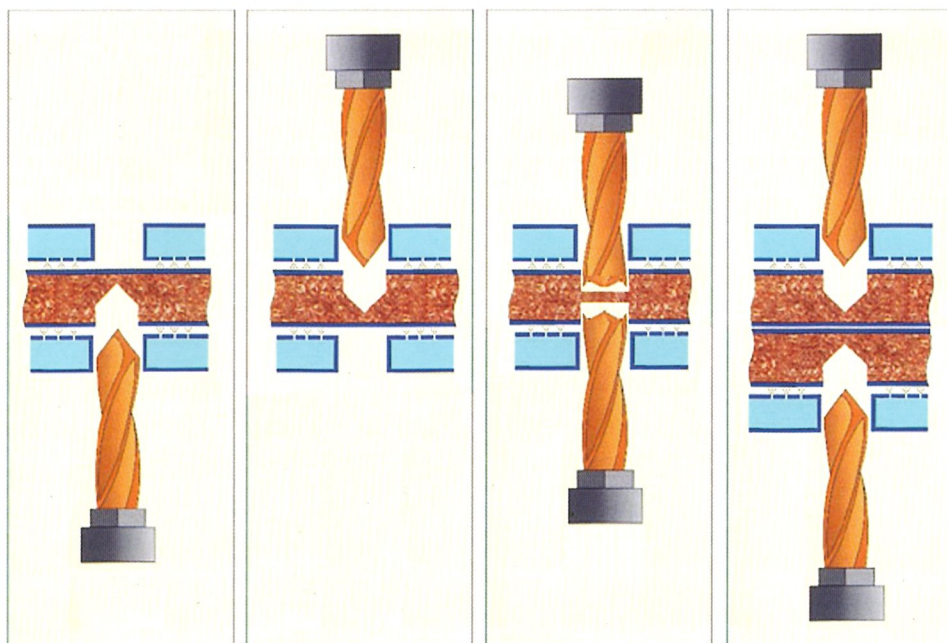

It is possible to perform different working cycles, as for example single panel processing with a through or blind machining production with mirrored machining.

For a total flexibility in customizing operating units composition

An extremely customizable machine which with the **great flexibility of the composition for the operating units** can satisfy all the requirements of the manufacturing of office furniture, kitchens, bedrooms, etc.

- Boring head with 15, 18 or 24 independent vertical spindles;
- From 6 to 32 independent horizontal spindles;
- Hinge drilling blocks integrated into the boring heads or interchangeable with a dedicated 2,2 KW independent motor
- Independent or integrated saw blade unit, fixed or rotating 0/90° by CNC
- 6,6 KW electrospindle with HSK63 attachment and pneumatic actuator with 0/90° or 0/180° rotation for dedicated units;

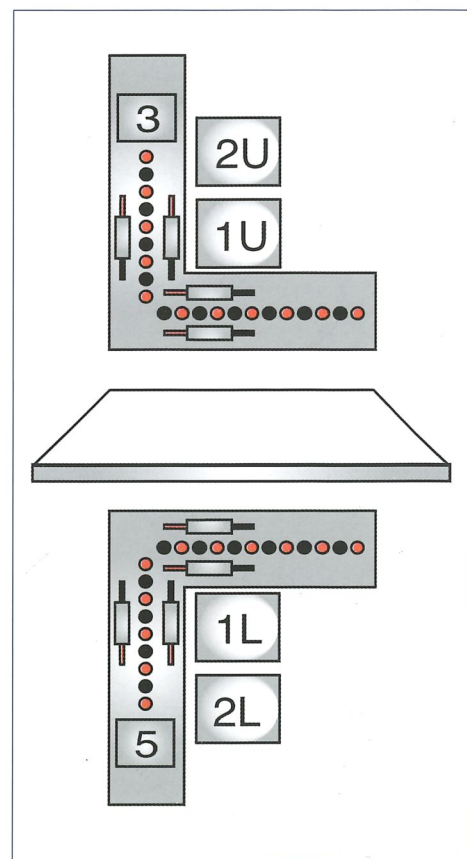
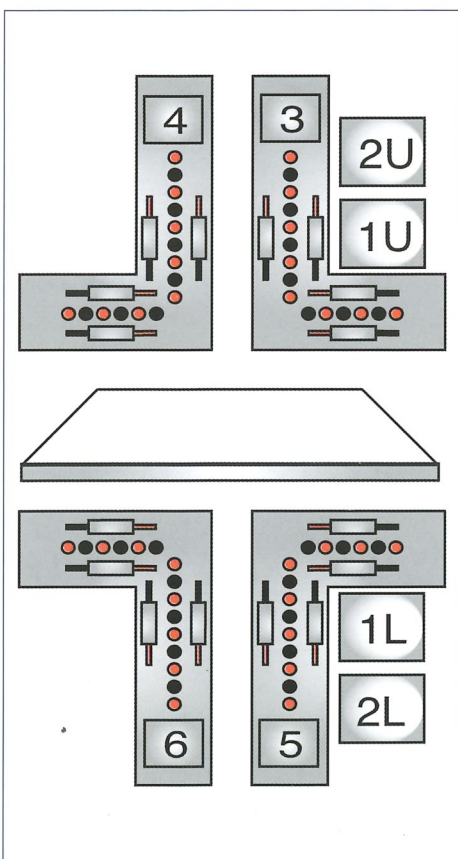
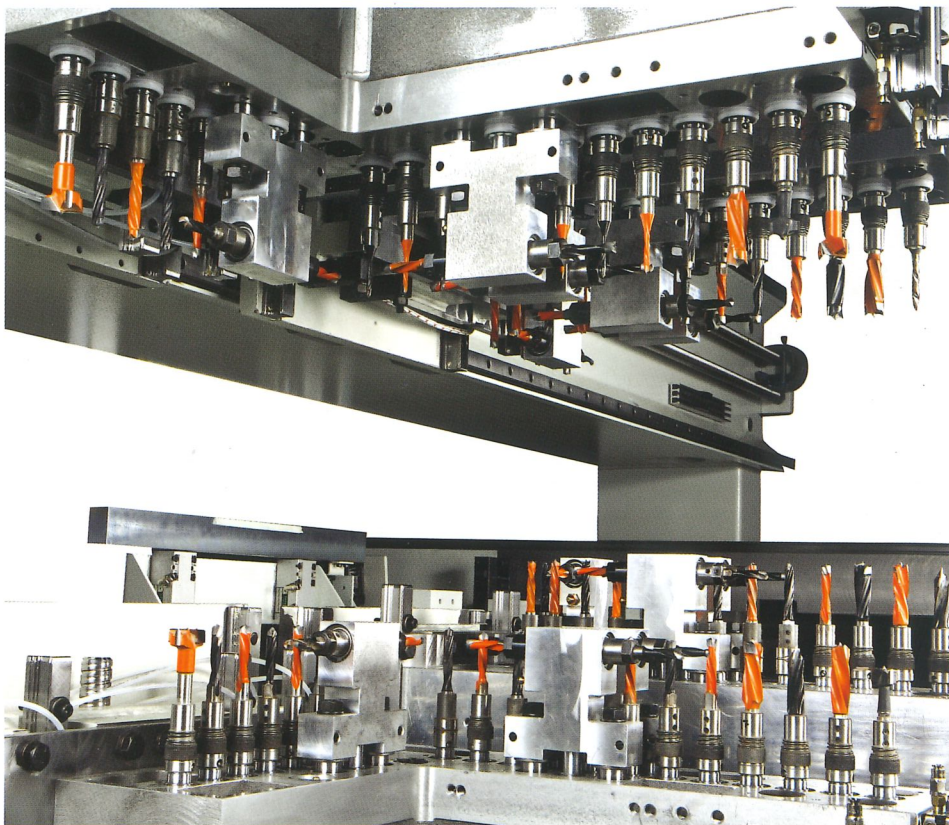

Unix BT•BTI•KBT

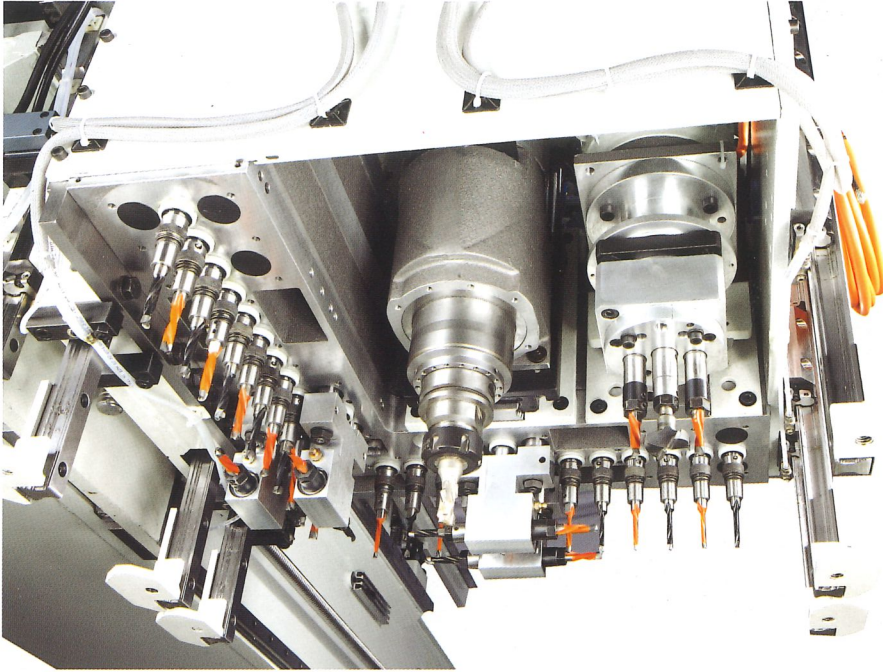

UNIX KBT upper head composition with:

- 24 independent vertical spindles
- 8 independent horizontal spindles
- Electro-spindle HSK63 attachment of 6,6 KW – 1.500 ÷ 24.000 rpm
- Boring unit head for hinges with three bits (interchangeable) with 2,2KW Independent motor

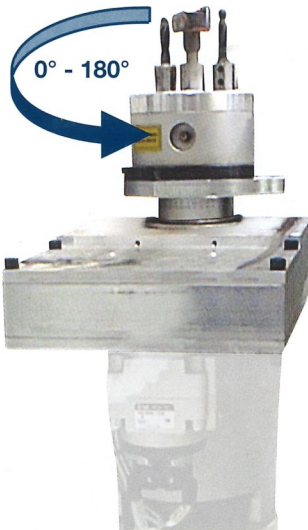

2,2 kW independent unit with 0/180° rotation, with three spindles for hinges boring head.

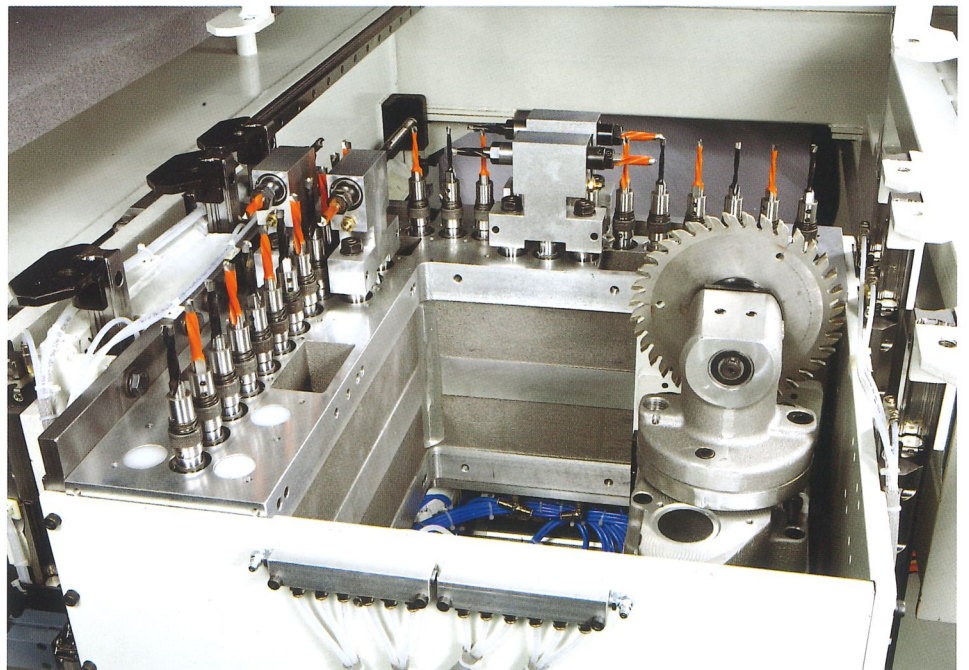

UNIX KBT lower head composition with:

- 24 independent vertical spindles
- 8 independent horizontal spindles
- Saw-blade unit Ø 150mm, 0/90° rotation positioning with 2,2KW motor

To handle your products with all the care they need

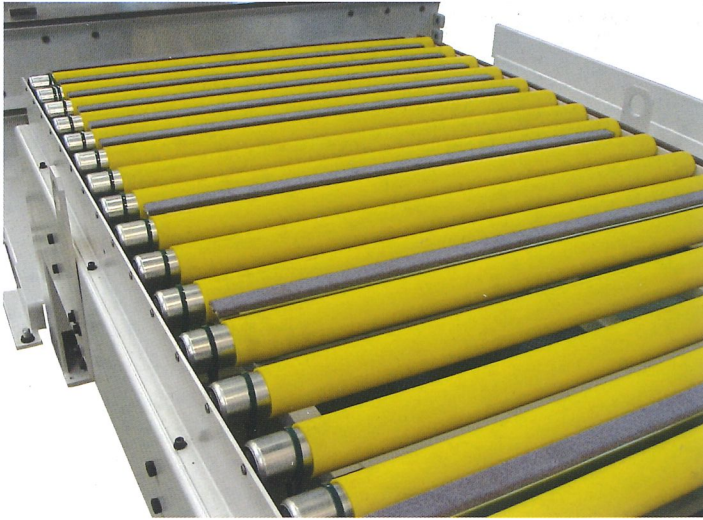

UNIX wide range of options of the handling devices allows many possibilities of configurations as “stand alone” machine or machine in line through-feed, automating all the loading and unloading operations.

It is possible to have configurations “stand alone” with panels automatic returning device or “hybrids” configurations with manual loading and automatic unloading.

A plentiful variety of roller systems, conveyor belts, or mat, makes Unix a unique machine on the market.



The shapes and dimension of each device has been carefully engineered, using innovative materials in order to assure the high moving performance also for lacquered and varnished panels ready to assemble (RTA).

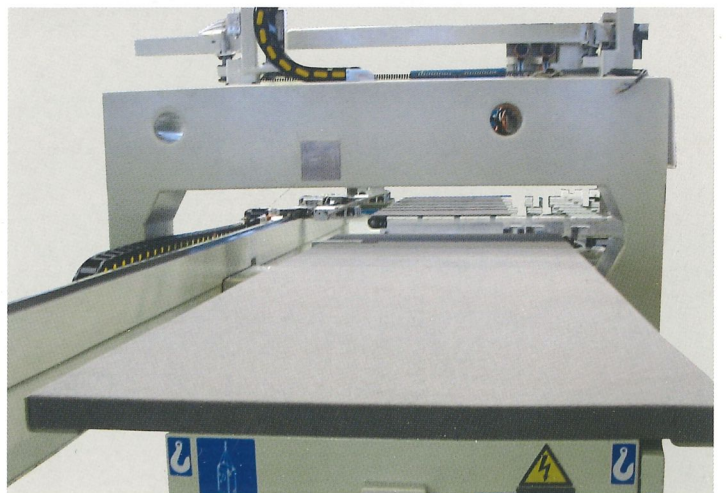

To insert the hardware in an automatic and safe way

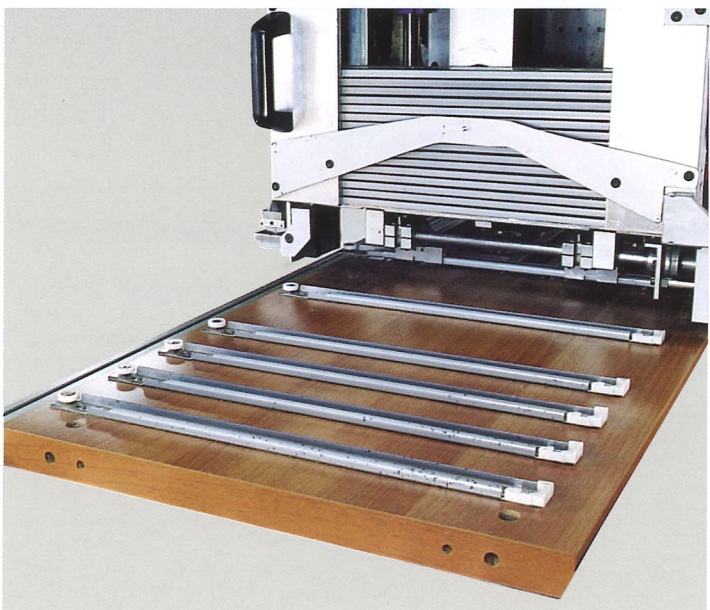
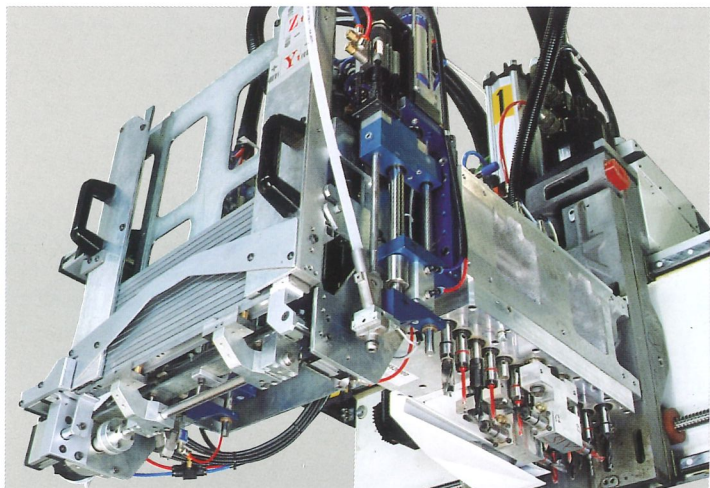

On the UNIX can be installed different units for any kind of hardware insertion, as bases for hinges, hooks for wall cupboard, bushes anchor and screw bushes, hinges, drawer guides, etc.

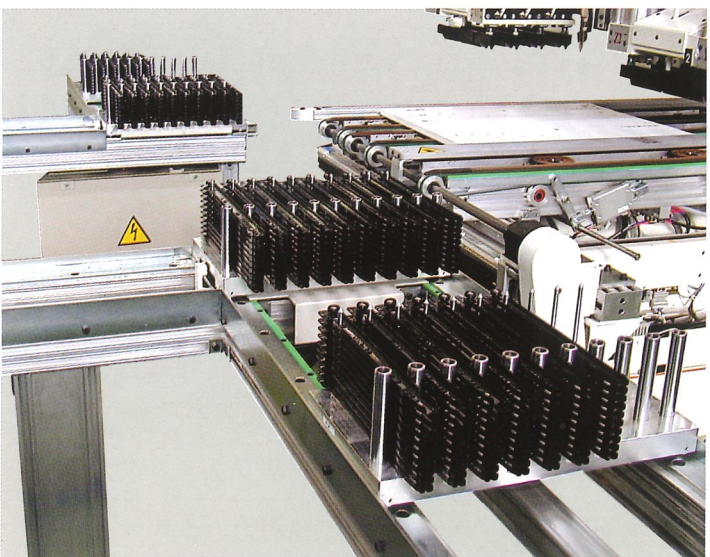

Vibration feeders can supply the insertion units manually or automatically, also with external cribs, for higher productive rate.

An easy and fast way to program

The managing unit of the machine is a **mobile console on wheels**, of **modern and ergonomic design**, on which there is installed a **high performance PC office**, complete with all the accessories and ports necessary for the connexion to any kind of the peripheral unit (modem, net connection, USB, etc.).

This solution guarantees the operator an **incomparable level of user-friendliness and comfort**, making work much easier Morbidelli software in Windows environment for **simple, effective programming**.

The software design takes into account programmer requirements, to cater for both expert operators and machining centre first time users.

The **graphical aids** allow intuitive programming, without extensive computer skills. Yet even those with more confidence will find something familiar in it, not requiring extra effort to take in new systems and will immediately be able to appreciate its great potential.

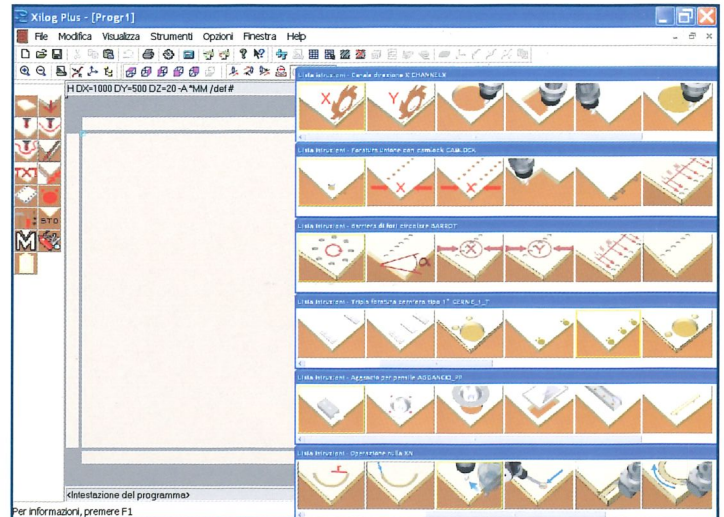
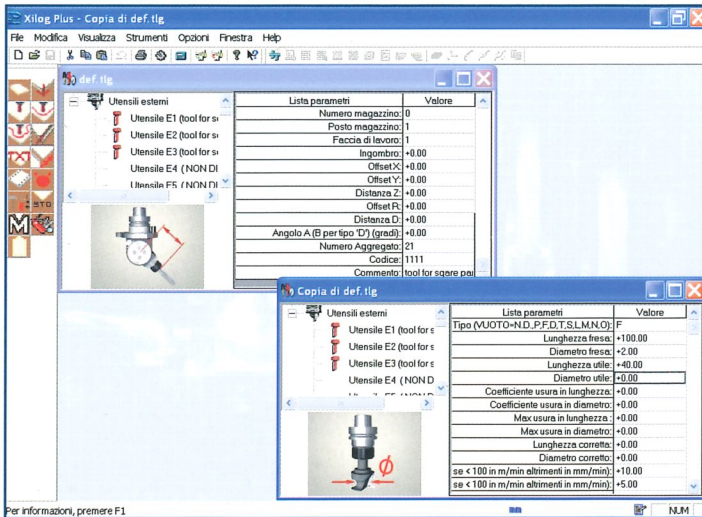

- Windows operating system with functions such as: copy, paste, edit, clear, properties, curtain menu, right click on the mouse for quick menu, multiple opening of windows etc.
- Equipping management with **tool visualisation** and with graphic supports to avoid the possibility of data input errors;
- **Immediate and direct uploads** of DXF format files;
- **Optimised dynamic drilling; graphic and syntactic aids** on drilling and milling operations to speed up data input operations;
- **Graphic visualisation of the manufactured piece** to allow for a quick and efficient check of the programme results;

- **Parametric programming**, to automatically update the programme when the sizes of the manufactured piece change, thus avoiding having to write a new programme;
- **Macro creation in a few minutes**, by using parametric programming;
- **Creation of programme blocks** that can be inserted inside other programmes;
- **Self diagnosis and warning of any errors** or possible failures through alarm messages in the user's language that aid quick understanding;
- **Execution of programmes through bar codes.**

Technical Data

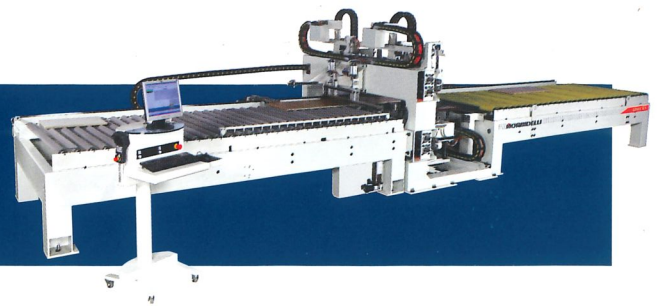

		UNIX BT	UNIX BTI	UNIX KBT
Working area	mm	2700 x 820	2700 x 820	3000 x 1000
	mm	3200 x 820	3200 x 820	
	mm	3200 x 1220	3200 x 1220	
	mm	3600 x 1420	3600 x 1420	
Boring heads		1/2/4	1/2/4	2
Integrated optional units		1/2/4	1/2/4	2 max
Independent optional units		4 max	4 max	4 max
Insertion unit		-	4 max	-
Vertical spindles (each head)		15/18	15/18	21/24
Horizontal spindles (each head)		6/8	6/8	6/8
Electro spindles power	kW	6,6	6,6	6,6
Saw-blade units power	kW	2,2	2,2	2,2
Working pieces	mm	60	60	60



The UNIX machine is protected on the all sides by effective CE safety systems (protection nets + sensible mats+ photoelectric cell + sensors) that prevent any contact, also if it is accidental, between the operator and the machine moving parts, during the normal working cycle.

Loading/unloading composition and overall dimensions

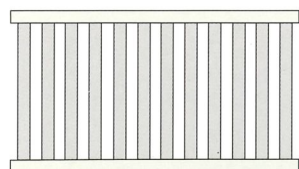
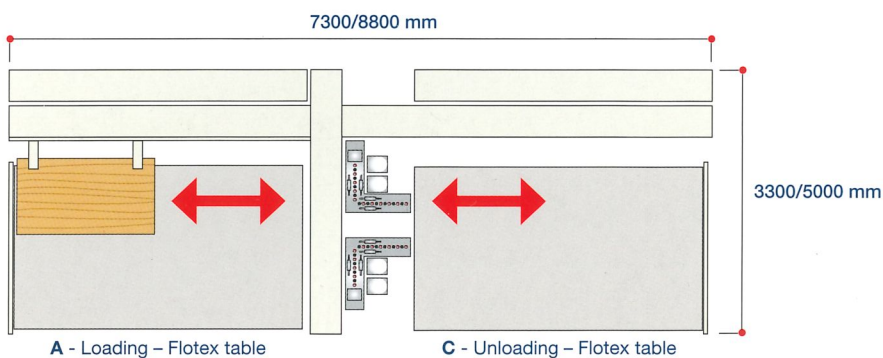

B - Loading - rollers table

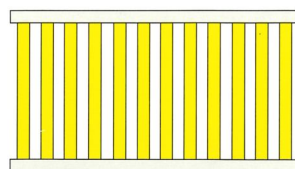

D - Unloading - rollers table

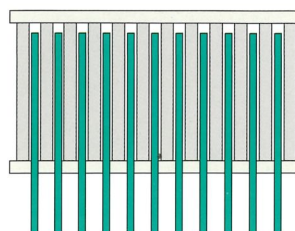

E - Unloading transversal belts table

Possible loading/unloading combinations

- A+C
- A+D
- A+E
- B+D
- B+E

The total overall of the machine changes depending on the model, working area, operating unit and panel handling composition. It's necessary to value the exact dimension time by time.

For demonstrative needs some photos reproduce machines complete with accessories. Without notice the technical data can be modified. The changes don't influence the safety foreseen by CE rules.

SINCERT



MORBIDELLI

MORBIDELLI

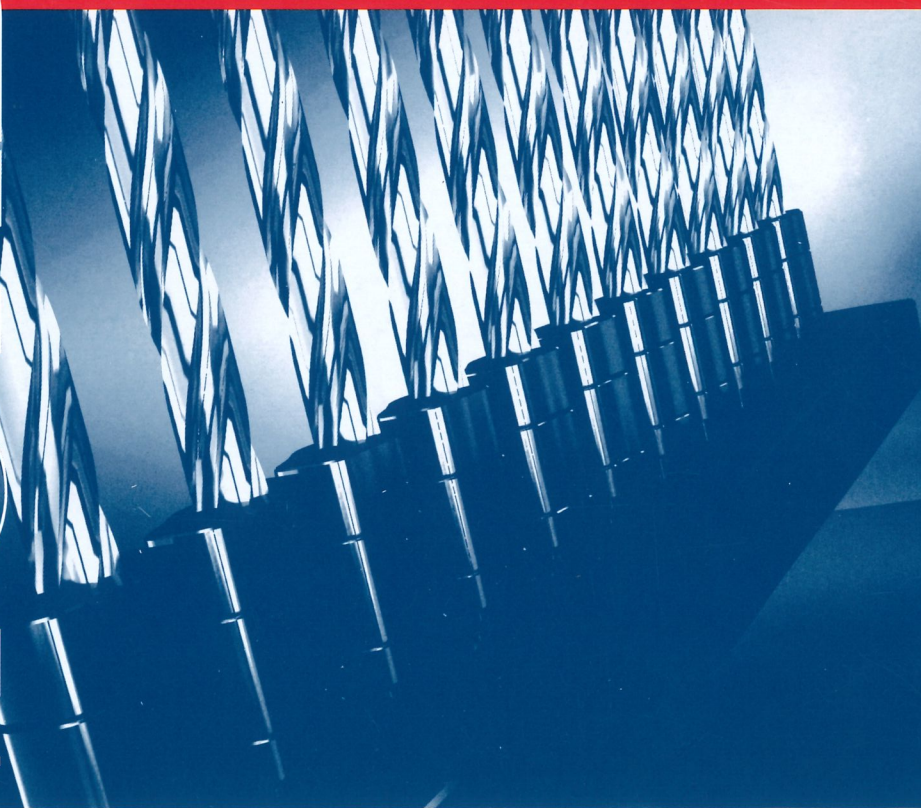

MORBIDELLI

SCM GROUP spa - MORBIDELLI - Strada Montefeltro, 81/3 - 61100 Pesaro - Italia
Tel. +39/0721/4451 - Fax +39/0721/445264 - www.scmgroup.com - E-mail: morbidelli@scmgroup.com