

scmgroup

SCM GROUP SPA SCM

sales offices: via Casale, 450 - 47826 Villa Verucchio, Rimini - Italy
tel. +39 0541 674111 - fax +39 0541 674274 - scm@scmgroup.com - www.scmgroup.com

scm



00L0132026E

REV. N. 00 - 02.2015 - AD LIFEINPIXEL - 

pratix

cnc machining centres with multifunction aluminium worktable.

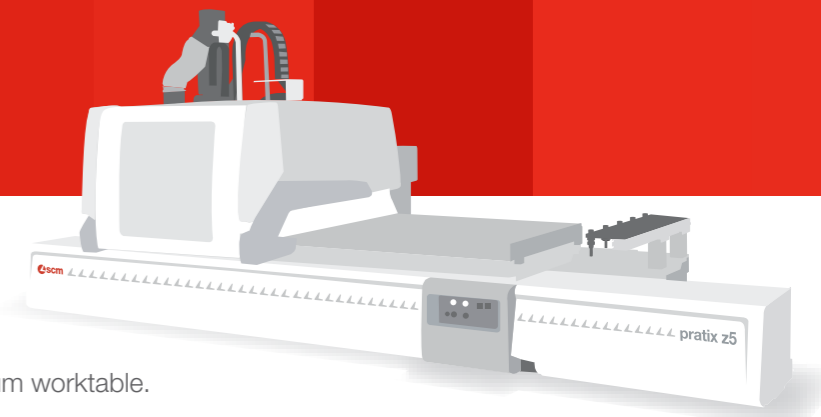

pratix z5

pratix z5

cnc machining centre with multifunction aluminium worktable.

- 5 axis
- work table with "T"-shaped grooves

pratix z2

pratix z2

cnc machining centre with multifunction aluminium worktable.

- 3-4 axis
- work table with "T"-shaped grooves

pratix n

pratix n

cnc machining centre with multifunction aluminium worktable.

- 3-4 axis
- high performance
- loading and unloading automation

pratix s

pratix s

cnc machining centre with multifunction aluminium worktable.

- 3 axis
- entry level



PRATIX Z5
page 04



PRATIX Z2
page 06



PRATIX N
page 08



PRATIX S
page 10



TECH Z5



CYFLEX F900 PRO



CYFLEX H810 PRO



TOP PLUS



MULTITECH PLUS



STARTECH



pratix z5

“Top-of-the-range” for those who consider flexibility as a way of life.

The very best multipurpose machine available due to the possibility to **size nested panels** and **bore-router already sized panels (also for alternated work process)**. Optimised time and resources thanks to the Netline integration.

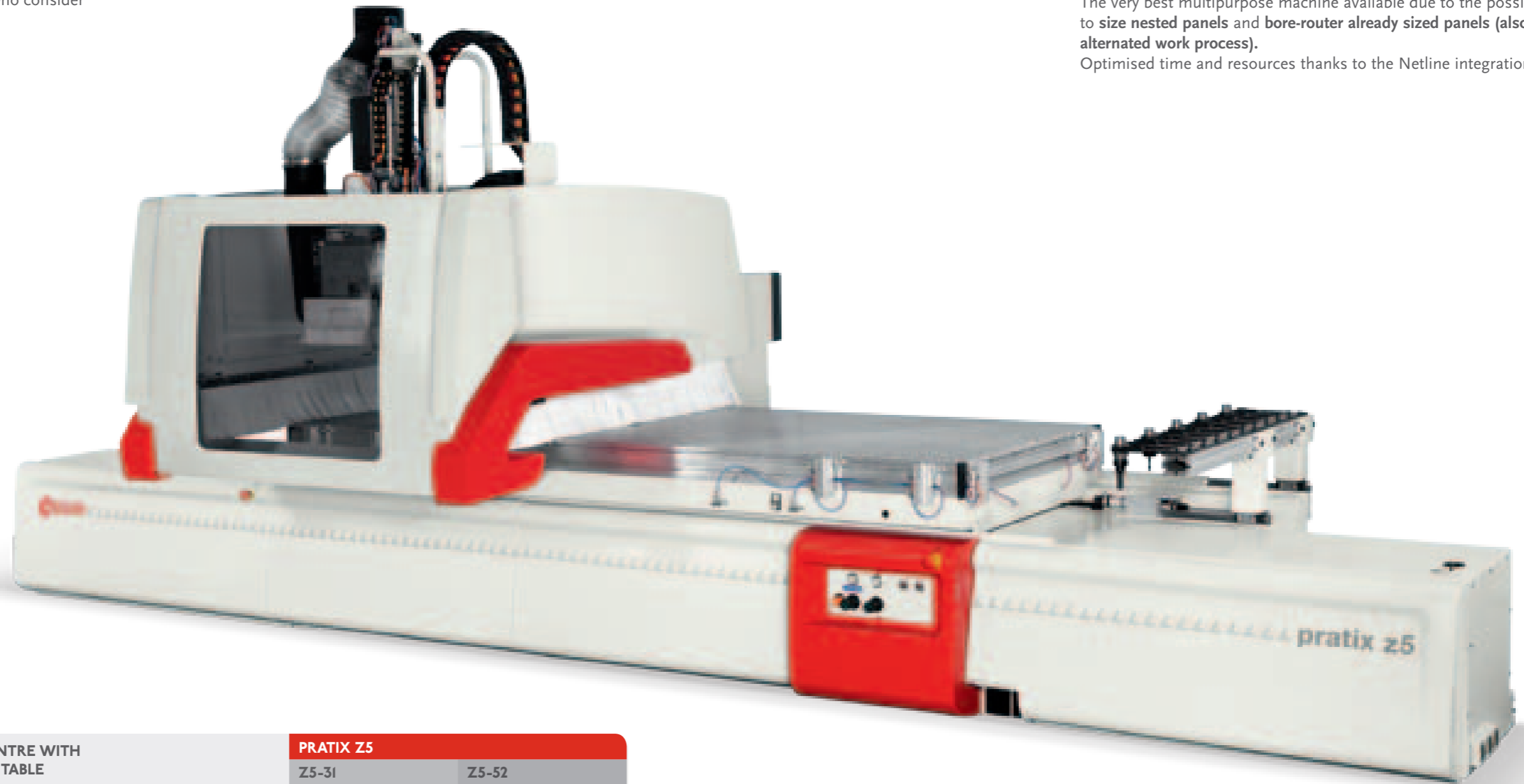

5 AXIS CNC MACHINING CENTRE WITH MULTIFUNCTION ALUMINIUM TABLE		PRATIX Z5	
		Z5-31	Z5-52
Axes			
Working area along X-Y-Z axes	mm	3110 - 1550 - 160	5200 - 1550 - 160
Panel length along Y axis	mm	1550	1550
Panel length (for alternated work process)	mm	1390	2460
Vectorial speed X-Y axes (option)	m/min	83	83
Boring head			
Vertical spindles up to	No. - rpm	18 (10X - 4+4Y) - 6000	18 (10X - 4+4Y) - 6000
Horizontal spindles up to	No. - rpm	8 (4X - 4Y) - 6000	8 (4X - 4Y) - 6000
Integrated blade in X	Ø mm - rpm	120 - 7500	120 - 7500
Electrospindle			
Std motor power (S1)	kW (Hp)	11 (15)	11 (15)
Max. speed	rpm	21000	21000
Tool changer on the carriage in X (base)	places	12	12
Installation			
Exhaust air consumption/speed	m ³ /hr - m/sec	5300/30	5300/30
Exhaust outlet diameter	mm	250	250
Total machine weight	Kg	3150	3350

pratix z2

Flexibility and effectiveness for any boring-routing requirement.

Customisation and flexibility due to an extensive choice of equipment presets with Scm aluminium work table and **Penta** function.



3-4 AXIS CNC MACHINING CENTRE WITH MULTIFUNCTION ALUMINIUM TABLE		PRATIX Z2		
		Z2-27	Z2-31	Z2-52
Axes				
Working area along X-Y-Z axes	mm	2750 - 1300 - 160	3110 - 1300 - 160	5200 - 1300 - 160
Panel length along Y axis	mm	1550	1550	1550
Panel length (for alternated work process)	mm	1210	1390	2460
Vectorial speed X-Y axes (option)	m/min	83	83	83
Boring head				
Vertical spindles up to	No. - rpm	18 (10X-4+4Y) - 6000	18 (10X-4+4Y) - 6000	18 (10X-4+4Y) - 6000
Horizontal spindles up to	No. - rpm	8 (4X-4Y) - 6000	8 (4X-4Y) - 6000	8 (4X-4Y) - 6000
Integrated blade in X	Ø mm - rpm	120 - 7500	120 - 7500	120 - 7500
Electrospindle				
Std motor power (S6)	kW (Hp)	12 (16,5)	12 (16,5)	12 (16,5)
Max. speed	rpm	24000	24000	24000
Tool changer on the carriage in X (base)	places	8 (10)	8 (10)	8 (10)
Installation				
Exhaust air consumption/speed	m ³ /hr - m/sec	3400/30	3400/30	3400/30
Exhaust outlet diameter	mm	200	200	200
Total machine weight	Kg	2400	2700	2900

pratix n

The passion for nesting.

Ideal machine for **nesting** requirements.

Wide accessories availability that allow the creation of a complete cell, without necessity of a second operator for panel moving.



3-4 AXIS CNC MACHINING CENTRE WITH MULTIFUNCTION ALUMINIUM TABLE		PRATIX N	
		NI2	NI5
Axes			
Working area along X-Y-Z axes	mm	2440 - 1220 - 150	3660 - 1550 - 150
Vectorial speed X-Y axes (option)	m/min	83	83
Boring head			
Vertical spindles up to (C and D versions)	No. - rpm	12 (8X - 4Y) - 4000	12 (8X - 4Y) - 4000
Horizontal spindles up to (option)	No. - rpm	6 (4X - 2Y) - 4000	6 (4X - 2Y) - 4000
Integrated blade in X (option)	Ø mm - rpm	120 - 5000	120 - 5000
Electrospindle			
Std motor power (S6) (C and D versions)	kW (Hp)	12 (16,5)	12 (16,5)
Max. speed	rpm	24000	24000
Tool changer on machine base	places	up to 20	up to 20
Installation			
Exhaust air consumption/speed	m ³ /hr - m/sec	3400/30	3400/30
Exhaust outlet diameter	mm	200	200
Total machine weight	Kg	3200	3500



<http://goo.gl/pjhtC>

pratix s

The entry-level machine for nesting operations.

The perfect machine for those who want to **begin machining by nesting**. Much reduced overall dimensions makes this machining centre the most **flexible** and **compact** available on the market and therefore **“perfect”** for **workshops with limited production space**.



3 AXIS CNC MACHINING CENTRE WITH MULTIFUNCTION ALUMINIUM TABLE		PRATIX S				
		S12	S15	S18	S22-31	S22-43
Axes						
Working area along X-Y-Z axes	mm	2486 - 1255 - 150	3686 - 1555 - 150	3686 - 1855 - 150	3086 - 2155 - 150	4286 - 2155 - 150
Vectorial speed X-Y axes	m/min	35	35	35	35	35
Boring head						
Vertical spindles up to (B version)	No. - rpm	7 (5X-2Y) - 6000	7 (5X-2Y) - 6000	7 (5X-2Y) - 6000	7 (5X-2Y) - 6000	7 (5X-2Y) - 6000
Horizontal spindles (option)	No. - rpm	4 (2X-2Y) - 6000	4 (2X-2Y) - 6000	4 (2X-2Y) - 6000	4 (2X-2Y) - 6000	4 (2X-2Y) - 6000
Integrated blade in X (option)	Ø mm - rpm	120 - 7500	120 - 7500	120 - 7500	120 - 7500	120 - 7500
Electrospindle						
Std motor power (S6)	kW (Hp)	6,6 (9)	6,6 (9)	6,6 (9)	6,6 (9)	6,6 (9)
Max. speed	rpm	24000	24000	24000	24000	24000
Tool changer on machine base	places	8	10	12	13	13
Installation						
Exhaust air consumption/speed	m ³ /hr - m/sec	3400 (5300*) /30	3400 (5300*) /30	3400 (5300*) /30	3400 (5300*) /30	3400 (5300*) /30
Exhaust outlet diameter	mm	200 (250*)	200 (250*)	200 (250*)	200 (250*)	200 (250*)
Total machine weight	Kg	1950	2200	2250	2550	2700

* = in presence of horizontal spindles



<http://goo.gl/UbXvA>



toptech
"BUMPERS": THE PERFECT COMBINATION OF SAFETY AND PRODUCTIVITY
The "bumpers" safety system is the only one that can fully exploit the potential of machining centres, without placing restrictions or constraints on the use of the machine:

- maximum productivity
- ease-of-use
- more compact dimensions
- guaranteed safety

pratix z5, pratix z2, pratix s



<http://goo.gl/46shV>

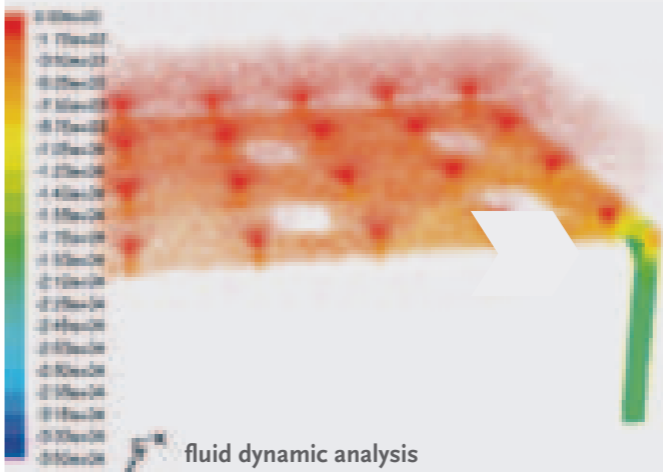

toptech
"HE" WORKTABLE: DESIGNED FOR EFFICIENCY AND SAVING.
Careful studies and tests allow us to achieve a high level of work piece holding down without resorting to several high-power vacuum pumps.

pratix n, pratix s

fluid dynamic analysis

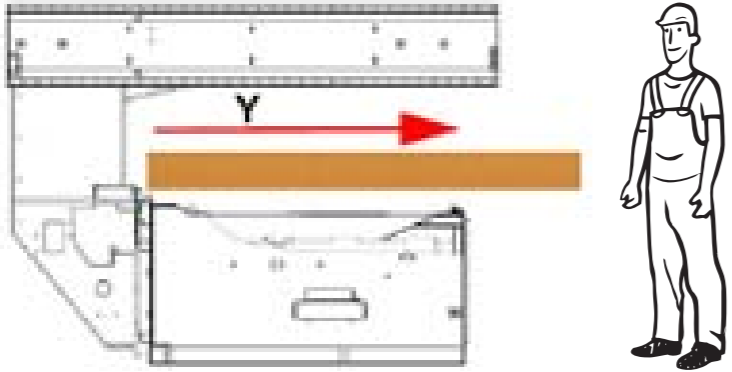

toptech
CANTILEVER STRUCTURE: UNIQUE AND EASY TO USE.
The only structure that allows the loading of components along the "Y" axis far larger than the working capacity of the machine.

pratix z5, pratix z2



<http://goo.gl/46shV>



toptech
"PRISMA5" 5AXIS ELECTROSPINDLE: OPERATING EASILY IN REDUCED SPACES WITHOUT RISK OF COLLISIONS.
No limits to the possible uses of the 5-axis "Prisma 5" group which, with the patented Scm solution, allows the keeping of the overall dimensions in each direction of travel to a minimum. This results in maximum operator convenience and flexibility of use.

pratix z5



"NETLINE": PROGRAMMING MACHINES AUTOMATICALLY.
The automatic programming of beam saws, edge banders and machining centres, interconnected via a PC with advanced software, allows the creation of complete projects without any operator intervention and no risk of errors.

pratix z5, pratix z2, pratix n

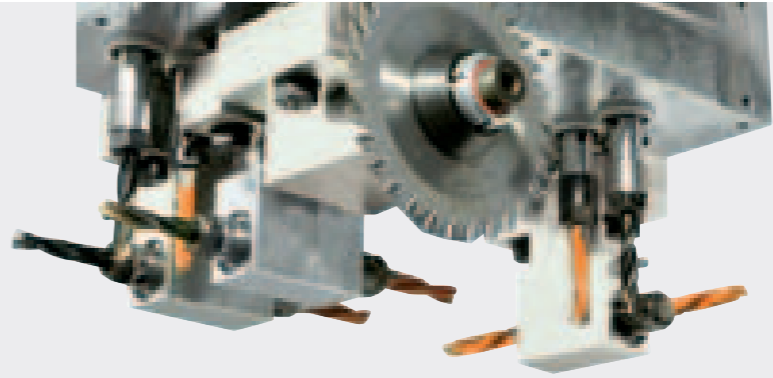

BORING HEADS: NO MORE MACHINE DOWNTIME.
The sturdiness of Scm boring heads is proven by the frequency of required maintenance, only every 1000 hours, five times better than that imposed by the majority of other machine manufacturers: indestructible and with low maintenance.

pratix

Exclusive features.

HORIZONTAL ELECTROSPINDLE: HIGH WORKING SPEED

The direct output of motion power without gears and sprockets, a guarantee of sturdiness, allows the processing of **heavy duty work easily and fast**, without having to worry about the possible breaking of the wood or the tooling.

pratix z2

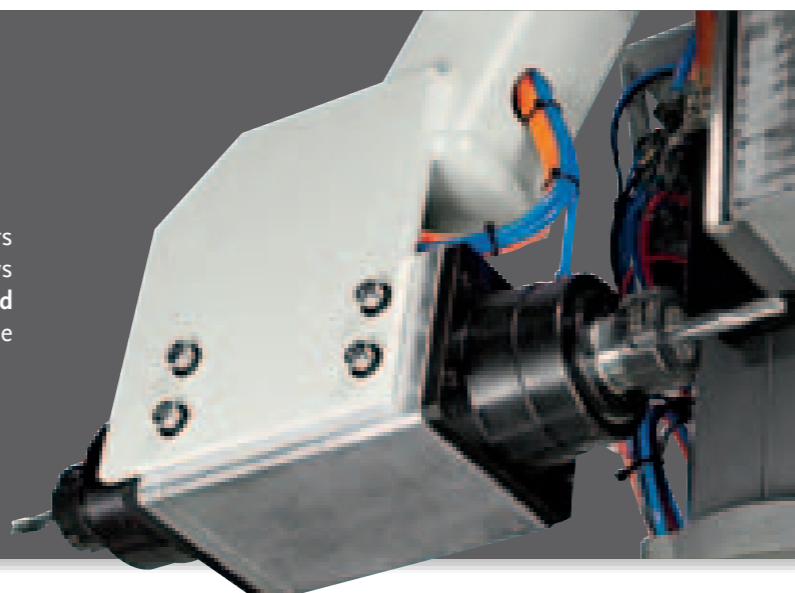

"PENTA" DEVICE: THE FLEXIBILITY OFFERED BY 5 AXES BUT AT A BUDGET PRICE.

The "Penta" device can **transform**, with a modest investment, a standard **4-axis machine** into a **perfect 5-axis** positioning one. Also available with automatic tool change.

pratix z2



<http://goo.gl/46shV>

"TECPAD": EASE-OF-USE AND PRODUCTIVITY AT FINGER TIPS.

The "Tecpad" standard remote control with LCD display, with **7"** colour touch-screen allows the operator to fully **manage the machine intuitively**. The commands are always close to both the machine and the operator.

pratix z5, pratix s

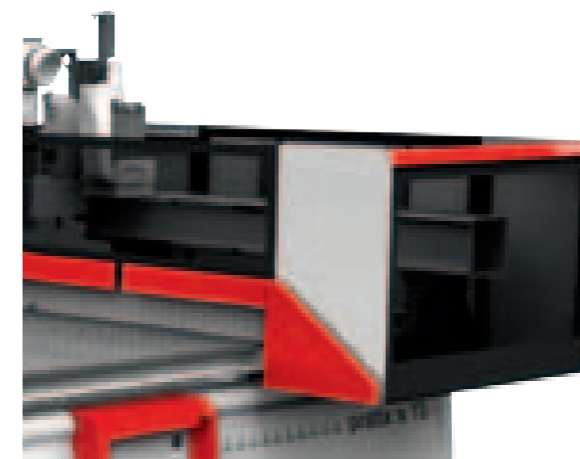

"PRO-SPACE" PROTECTIONS: SAFE AND COMPACT.

Ideal for those with limited available space, it is distinguished by:

- absence of perimeter protections
- protections mounted directly on the mobile upright
- also free access to the rear of the machine

pratix s



"PRO-SPEED" PROTECTION: THE BEST COMPROMISE BETWEEN SPEED AND COMPACTNESS.

X-axis speed up to **70 m/min** due to the new Scm solution using the **photo-bumpers** system, ensuring reduced overall dimensions, maximum safety and ease-of-use.

pratix z5, pratix z2, pratix n

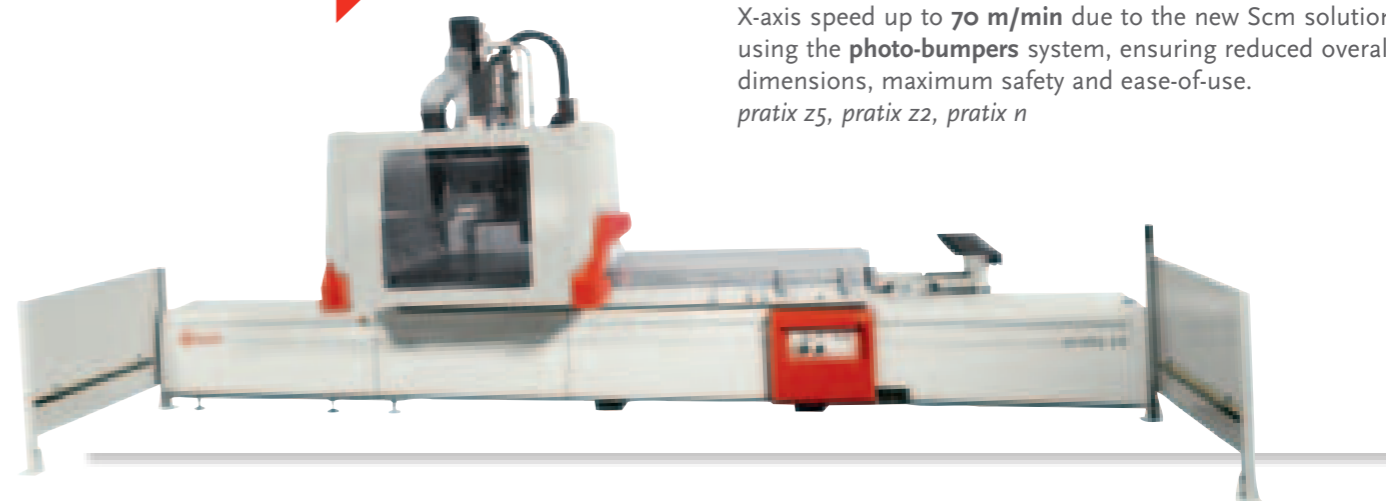

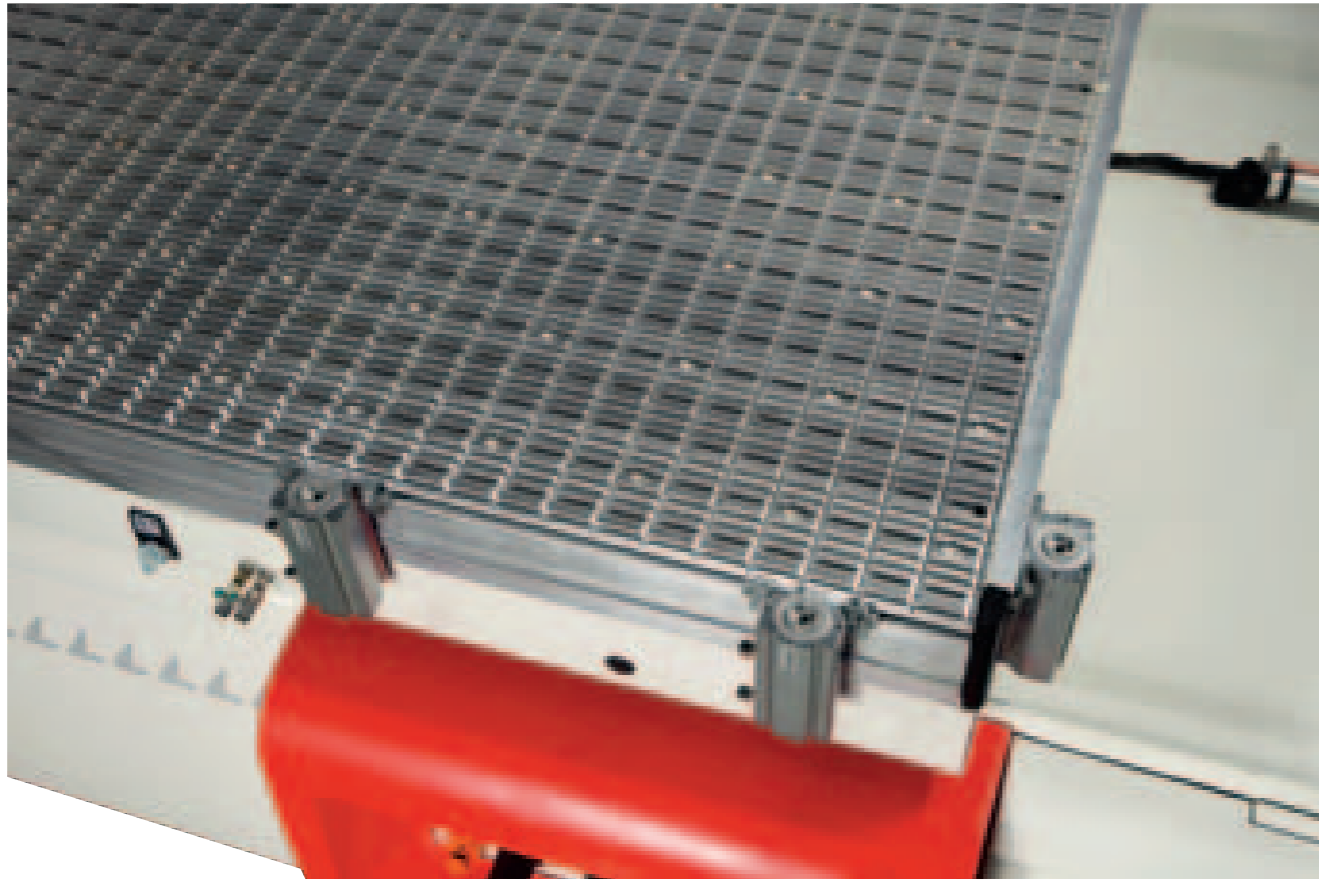

ALUMINIUM MULTIFUNCTION WORKTABLE WITH T-SHAPED GROOVES.

Flexibility of use at the very best levels of production with the possibility to add to the standard vacuum work tables systems, support for panels or suction cups. Also within the network of grooves, any type of support can be mechanically fixed to the table.

pratix z5, pratix z2

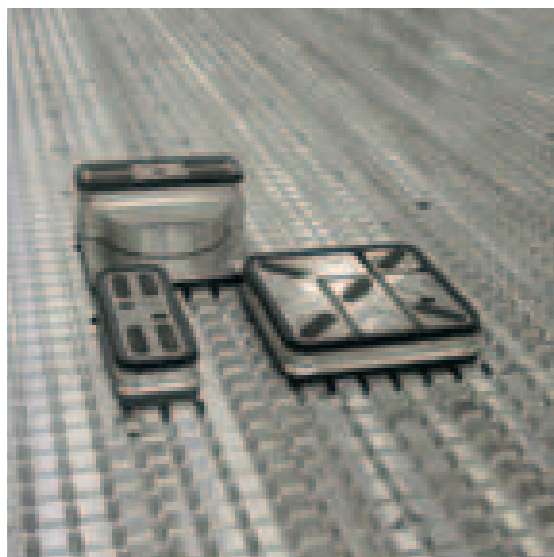

“HE” WORKTABLE:

DESIGNED FOR EFFICIENCY AND SAVING.

Careful studies and tests allow us to achieve a high level of work piece holding down without resorting to several high-power vacuum pumps.

The result:

- secure hold down of the work piece = excellent machining speed
- internal flows' speed of up to 250Km/h = efficiency on the whole worktable
- less consumption = energy saving (ecologically beneficial)

pratix n, pratix s



Specific operating group for pratix z5:

- boring head
- “Prisma 5” 5 axis electrospindle, 11 kW - 15 HP with water cooling group

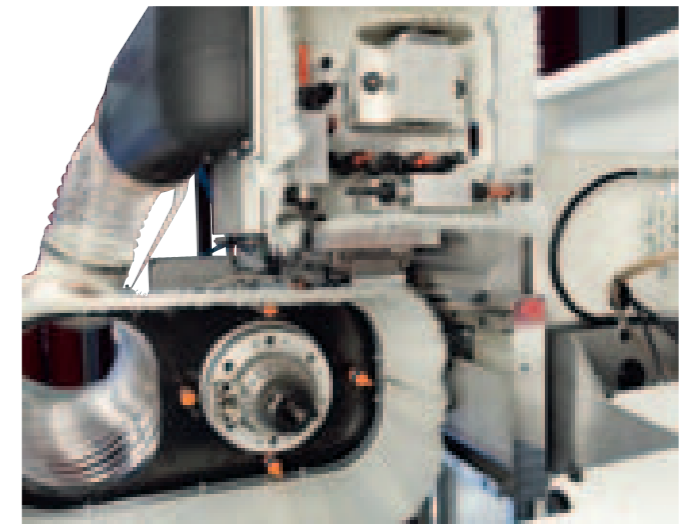
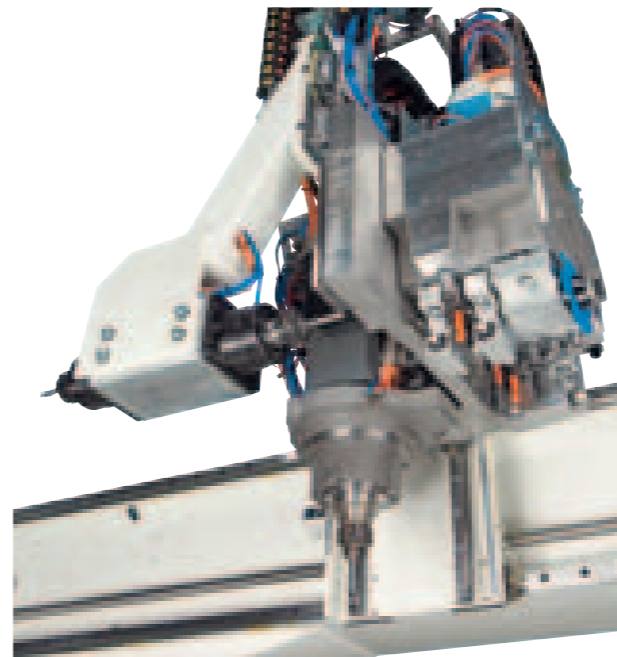

Specific operating group for pratix z2:

- boring head
- 12 kW - 16,5 HP vertical electrospindle
- 5 kW - 7,6 HP horizontal electrospindle (C, D versions)
- interpolating Vector axis (C version)

Specific operating group for pratix n:

- boring head (B, C, D versions)
- 12 kW – 16,5 HP electrospindle (C, D versions)
- interpolating Vector axis (option)

Specific operating group for pratix s:

- boring head (B version)
- 6,6 kW - 9 HP electrospindle

pratix

Boring heads.

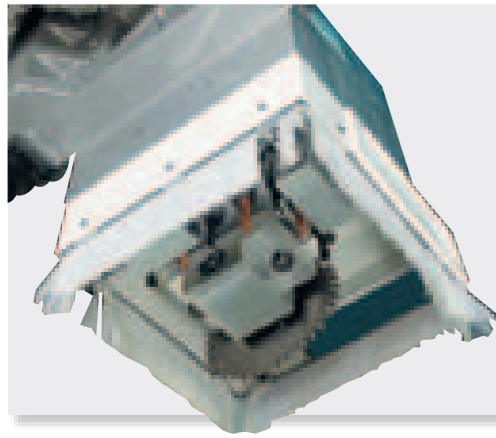

Boring unit with 7 vertical spindles and 4 horizontal spindles.
No. 1 integrated blade along X direction (120 mm maximum diameter).
pratix n, pratix s



Boring unit with 12 vertical spindles and 6 horizontal spindles.
No.1 integrated blade along X direction (120 mm maximum diameter).
pratix z5, pratix z2, pratix n

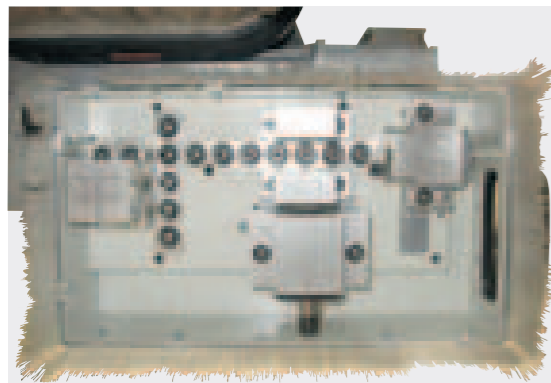

Boring unit with 12 vertical spindles and 8 horizontal spindles.
No. 1 integrated blade along X direction (120 mm maximum diameter).
pratix z2



Boring unit with 18 vertical spindles and 8 horizontal spindles.
No.1 integrated blade along X direction (120 mm maximum diameter).
pratix z2



Extensive customisation possible
with quick attachments for boring heads and angular heads having 1, 2 and 4 outlets with HSK taper couplings for angled routing, boring and grooving with plays elimination system or fixed mechanical couplings.
pratix z2, pratix n, pratix s

pratix

Tool changers.



TR8, TR10, TR12, TR13 tool changer
Positioned on the machine base.
No problems even with large dimensioned tools.

R12 tool changer

Positioned on the machining head support. It provides reduced setting-up times and higher tool-holder magazines capacity.

pratix z5

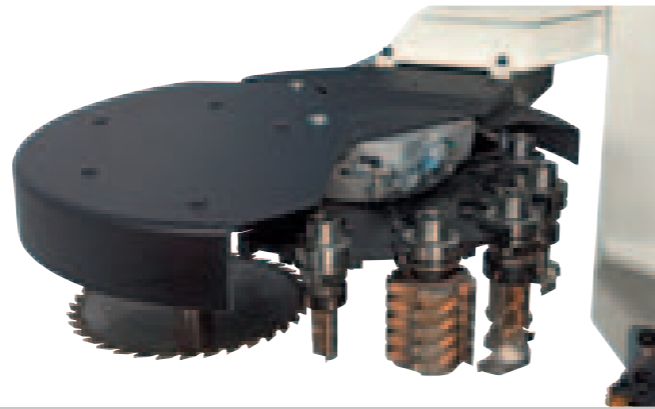

R8 tool changer

Faster machine tool changeover due to the tool changer mounted on the machining head support.

pratix z2, pratix n

“Pick up” tool changer

with pneumatic positioning on the machining head support. Ideal equipment when using large dimensioned angular driven heads.

pratix s

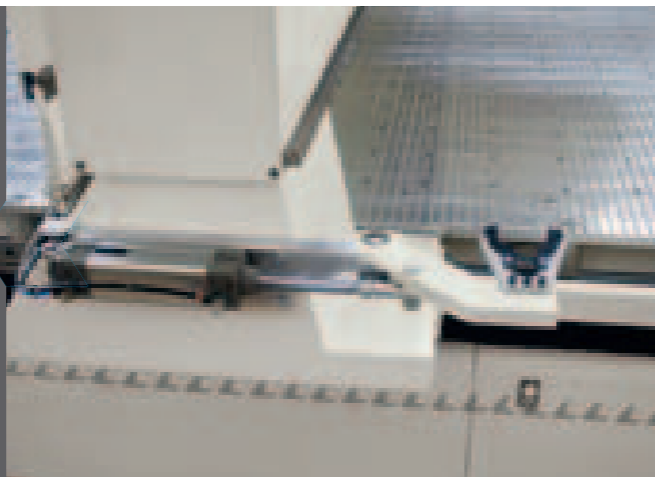

pratix

Other devices.



Telesolve

Teleservice system to connect the machine’s PC to the service department by means of the internet.

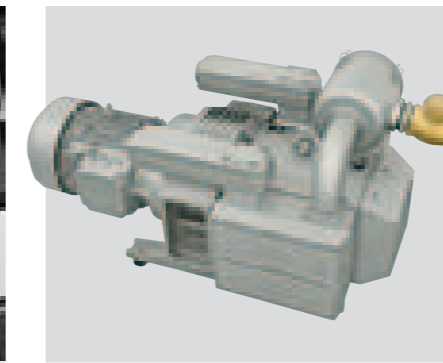

Upgrade

To 250 m³/hr 50 Hz pump (option).

A.C.



Electrical cabinet

with air conditioner which maintains the temperature at around 18°C. (option).



Laser

managed by optimisation software for correct positioning of each bar and suction cup (option).
pratix z5, pratix z2, pratix n

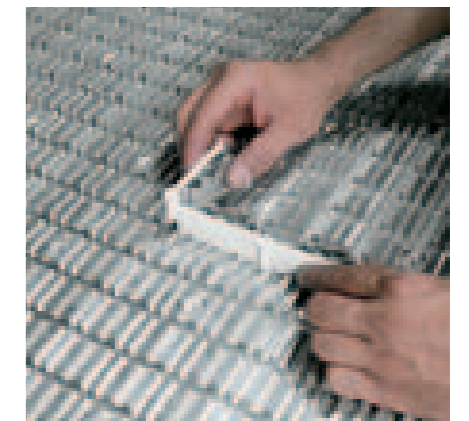
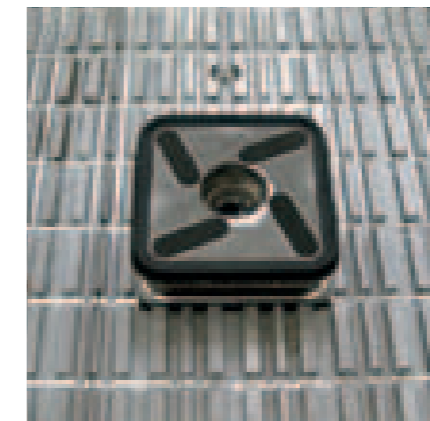

Extensive choice of MPS and MODULSET suction cups

- 90 x 90, 120 x 50, 130 x 130, H = 25 mm
- 130 x 50, H = 50 mm
- ø 120, H = 50 mm with an automatic lifting device



**VECTOR AXIS:
NO LIMITS TO MACHINING.**

Simple and precise operations using the digitally controlled Vector Axis managed by the NC, allowing 360° rotation and automatic positioning on “X” and “Y” axes of all angular heads.
pratix z2, pratix n



Centralised lubrication with manual pump.
pratix s

Automatic centralised lubrication managed using NC control.
pratix z5, pratix z2, pratix n



DEVICES FOR PARTICULAR APPLICATIONS

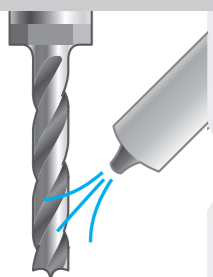

Air blower on electrospindle for generic applications.

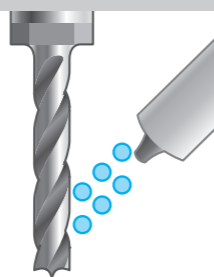

Ionized air blower on electrospindle
It is suitable to eliminate the electrostatic charges due to the cut material, making easier the shavings suction (advisable for plastic materials machining).
pratix z2, pratix n



Air blower with microlubrication
Air blower with very little oil quantity for the tool lubrication and cooling when used on coated panels.
pratix z2, pratix n



Bellows for guides protection in x and y axes
This device is compulsory for plasterboard machining.
pratix z5, pratix z2, pratix n



The perfect solution to easily assist the operator's work
Nesting cell with lift table and unloading belt (also available with the loading version only or the unloading one).

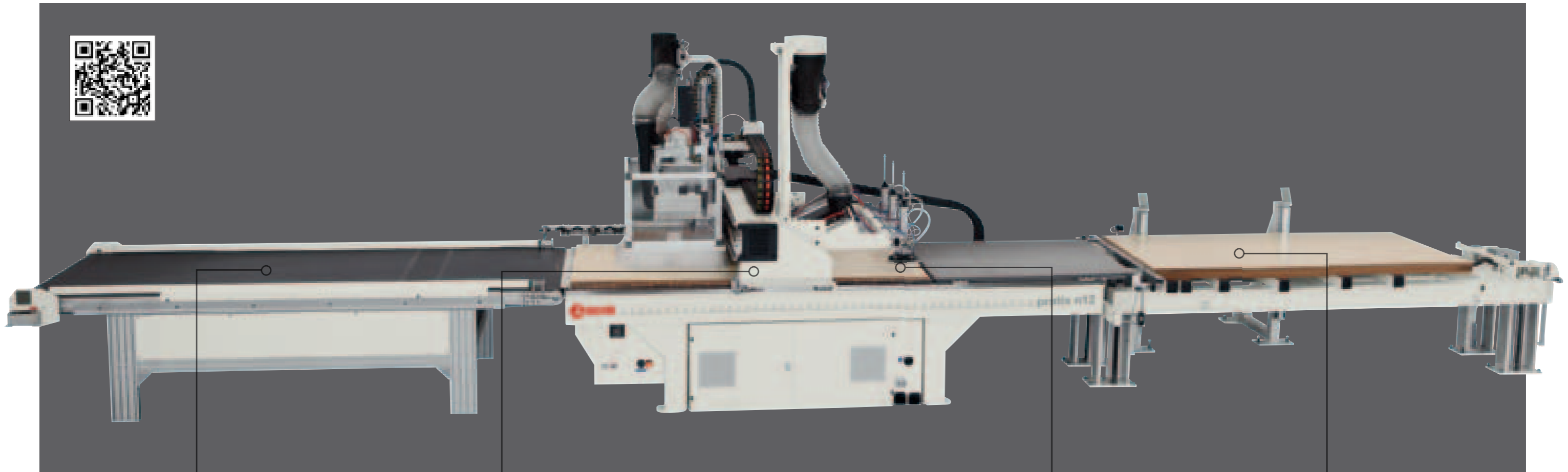

Unloading belt
with photocell detection system.

Work piece outfeed pusher
with centralised optimised cleaning system for the table and side guides to avoid accidental work piece ejection.

Work piece loading group with 3 suction cups

Automatic lift table

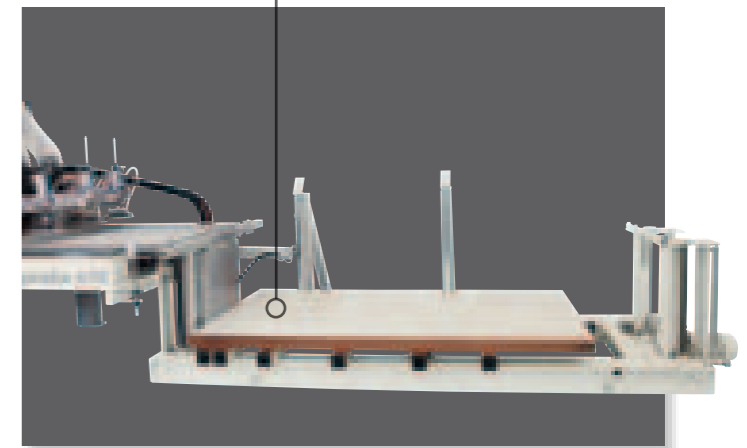
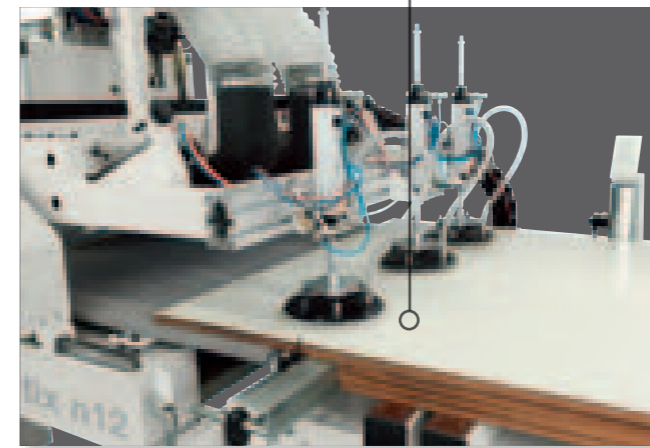
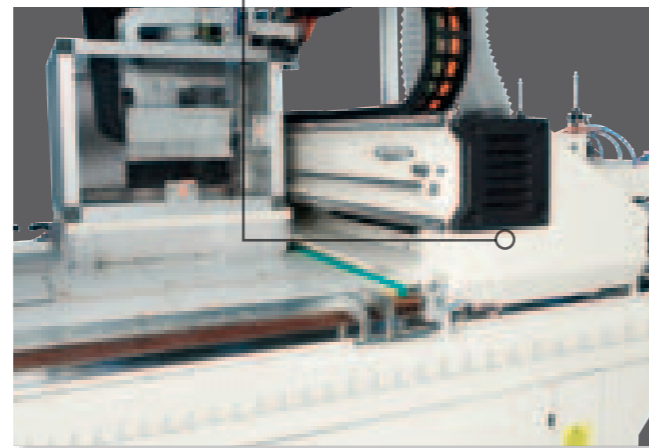

pratix

Loading/unloading automation

- ▶ Nesting cell
- ▶ Work piece labelling

RAPID AND SIMPLE OPERATIONS

From a rough panel to the finished piece of furniture through all the manufacturing phases.

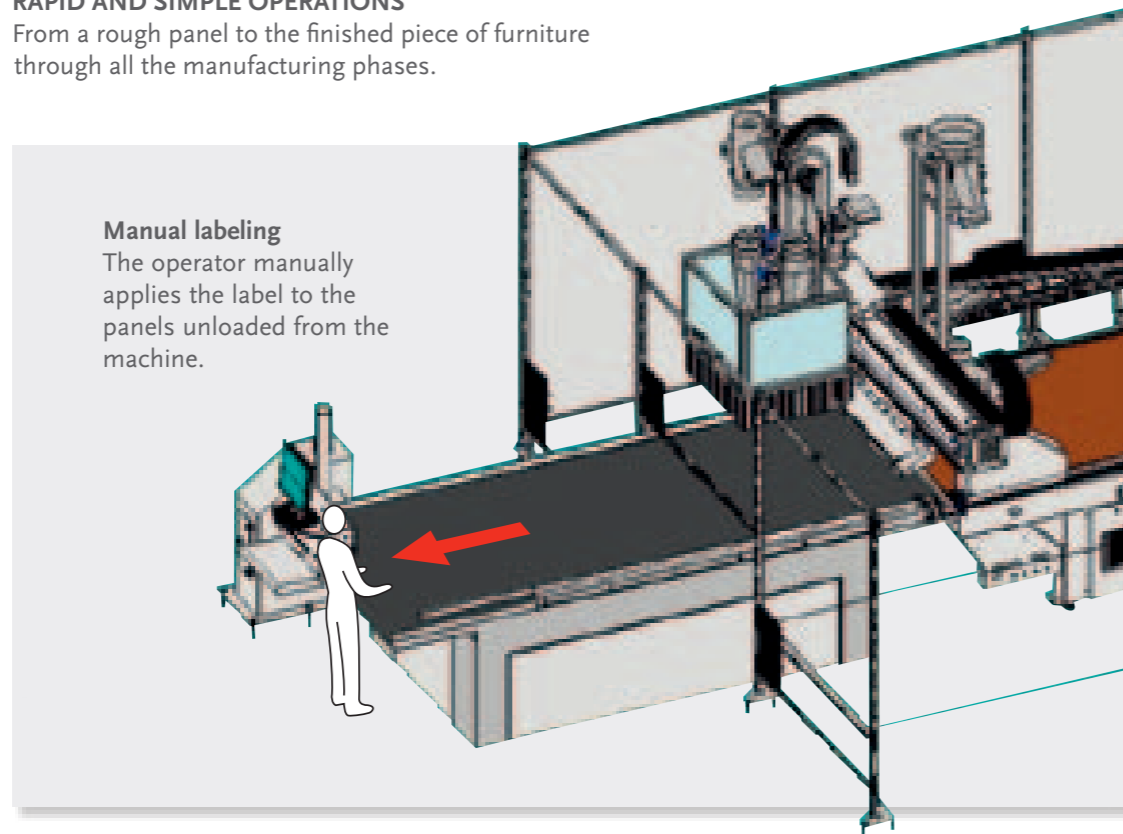

[http://goo.gl/p\]htC](http://goo.gl/p]htC)

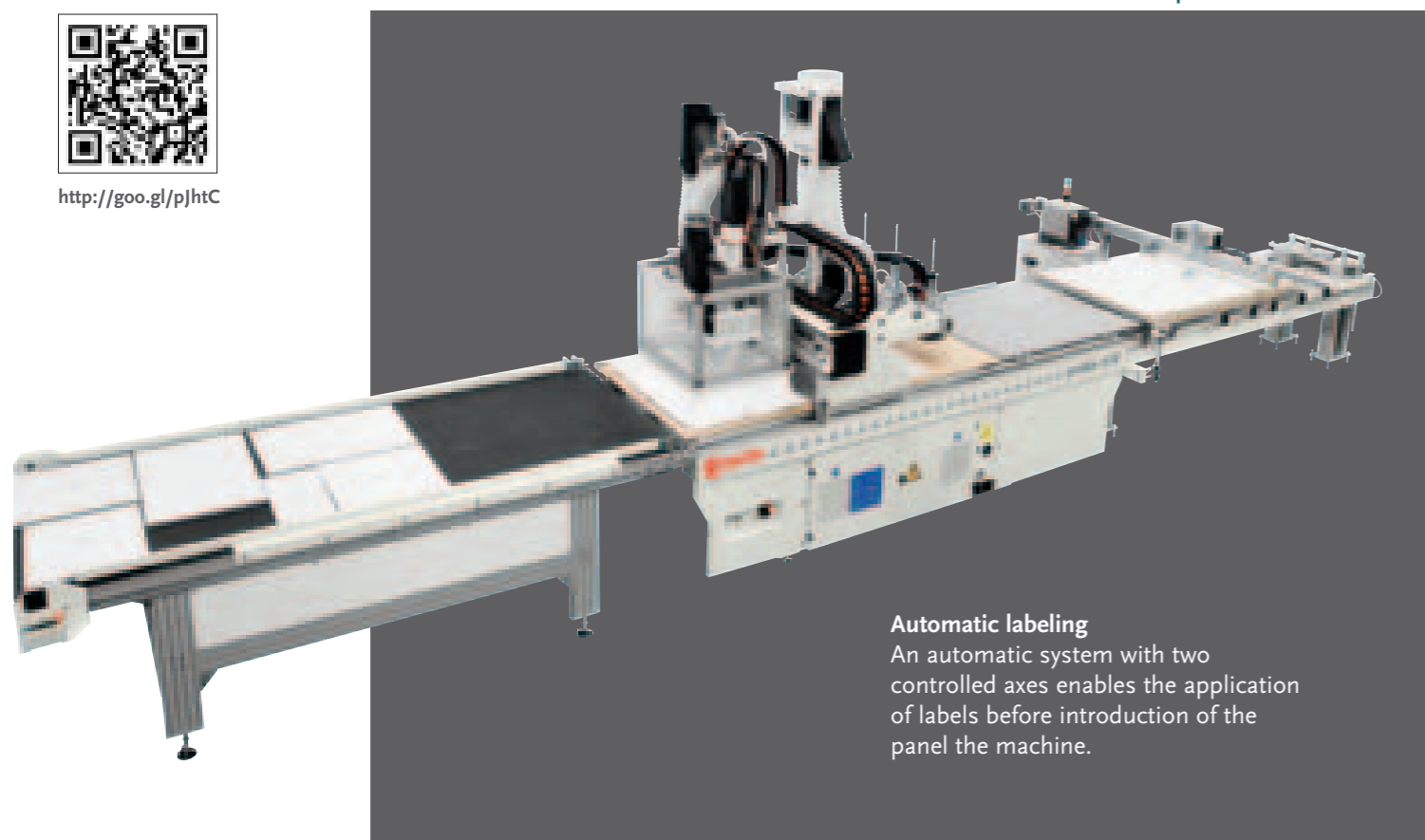

pratix

Loading/unloading automation

- ▶ Automatic unloading with the outfeed on the right side

PNEUMATIC UNLOADING DEVICE WITH THE OUTFEED ON THE RIGHT SIDE

The operator can position the workpiece just processed while the machine works the following panel thanks to the automatic feed of the workpiece outside the working area.

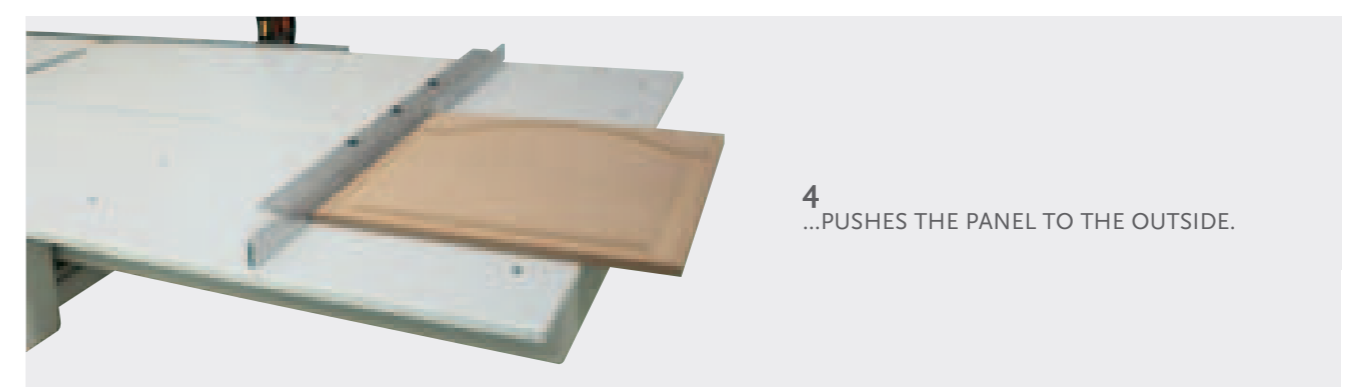
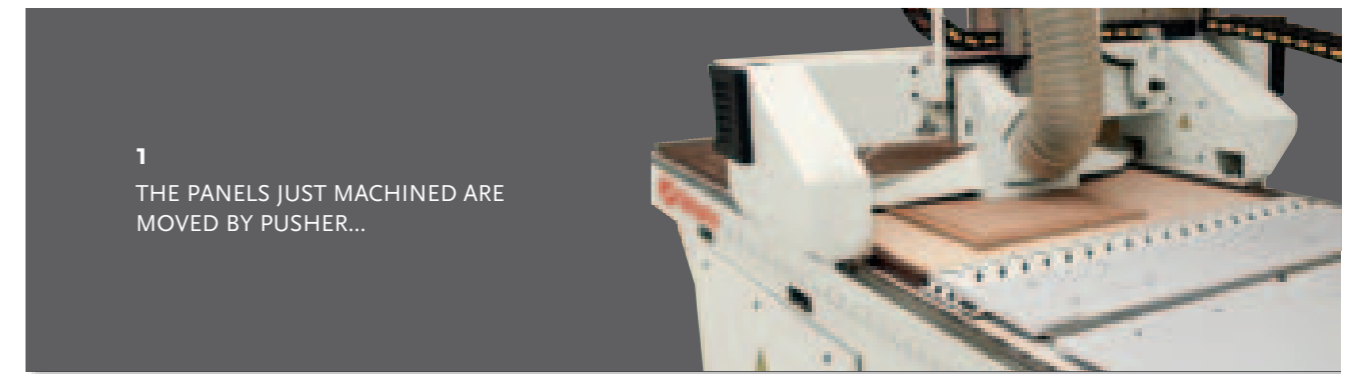

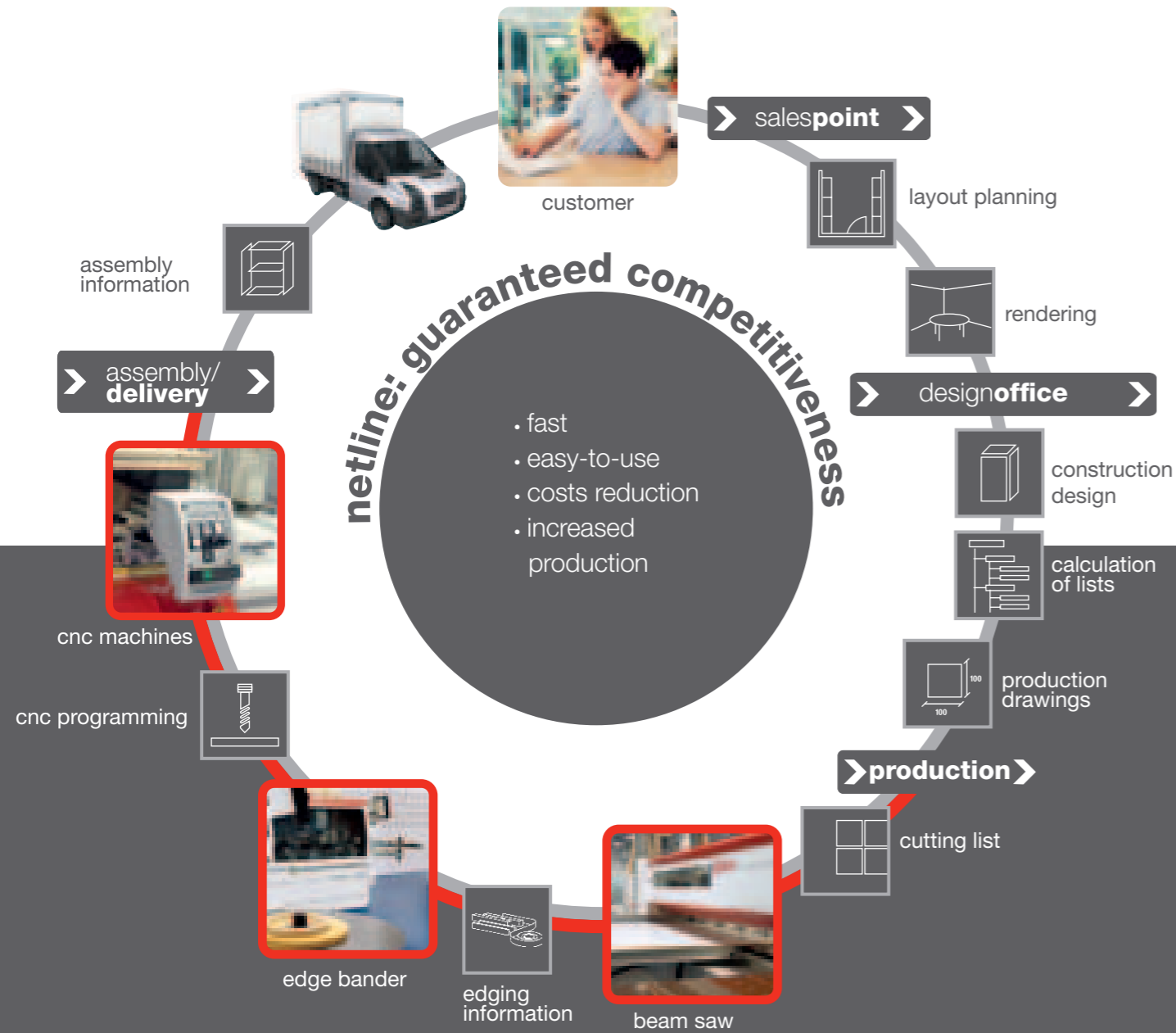

netline: integrated processing advantages

- **Fast:** very high execution speed and production time reduced to a minimum
- **Easy-to-use:** does not require skilled operators
- **Costs reduction:** a few minutes from design to production
- **Increased productivity:** the software-machine integration sets to zero the programming time due to the automatic and immediate switching of information from design to production



<http://goo.gl/fBp9q>

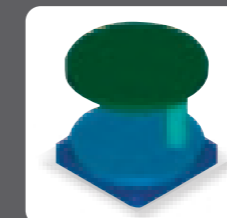

3D graphic set-up of work table

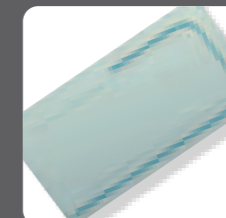

graphics library

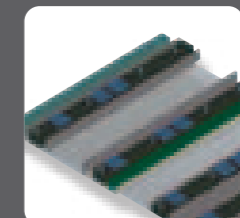

programming work table from 3D graphics



maestro nesting



maestro cabinet

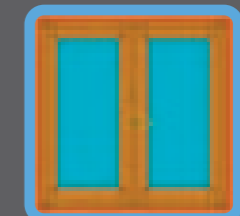

maestro wd

xilog maestro from the scmgroup: the advantage of having simple and intuitive software

- **Easy-to-use:** easy planning of 3D elements due to the software modules:
 - maestro cabinet:** to create complete cabinets and furniture
 - maestro nesting:** for rectangular and free-form elements it also ensures reduced production time and tool paths
 - maestro wd:** to create complete fastenings
- **Intuitive:** intuitive programming due the pre-set large graphics macro library
- **Immediate:** work table immediately set-up from 3D graphics

▼ ideal set up for:	▼ pratix z5	▼ pratix z2	▼ pratix n	▼ pratix s
MINIMUM SET-UP			<ul style="list-style-type: none"> ▶ 7,5 kW electrospindle ▶ Vacuum area for half or entire working area ▶ 90/108 m³/hr 50/60 Hz vacuum pump (pratix n12) ▶ 250/300 m³/hr 50/60 Hz vacuum pump (pratix n15) ▶ Xilog Maestro and Telesolve software 	
“A” PANEL MACHINING		<ul style="list-style-type: none"> ▶ Remote control for machine controls ▶ Optimised centralised exhaust outlet ▶ F12 boring head with 12 kW electrospindle ▶ Set up for angular heads with preloading and TR10 tool changer ▶ Automatic centralised lubrication ▶ Multifunction aluminium worktable ▶ 3 stops for “A” field, 3 stops for “D” field ▶ 90/108 m³/hr 50/60 Hz vacuum pump ▶ Xilog Maestro and Telesolve software 	<ul style="list-style-type: none"> ▶ 7,5 kW electrospindle with TR10 tool changer ▶ Vacuum area for half or entire working area ▶ Automatic centralised lubrication ▶ 250/300 m³/hr 50/60 Hz vacuum pump ▶ Preset for second 250/300 m³/hr vacuum pump ▶ Xilog Maestro and Telesolve software 	<ul style="list-style-type: none"> ▶ 6,6 kW electrospindle with Tecpad control ▶ Preset for heads with fixed mechanical coupling system ▶ Tool changers: TR8 for S12 • TR10 for S15 • TR12 for S18 • TR13 for S22-31 ▶ HE multifunction aluminium table ▶ 4 right rear stops for D field ▶ Machining on a single area ▶ Centralised lubrication with manual pump ▶ Presetting for up to 2 vacuum pumps ▶ Nesting rectangular module for Xilog Maestro ▶ Xilog Maestro and Telesolve software
“B” GENERIC APPLICATIONS		<ul style="list-style-type: none"> ▶ Remote control for machine controls ▶ Optimised centralised exhaust outlet ▶ F12 boring head with inverter ▶ 12 kW electrospindle and R8 tool changer ▶ Set up for angular heads with preloading ▶ Automatic centralised lubrication ▶ Multifunction aluminium worktable ▶ 3 stops for “A” field, 3 stops for “D” field ▶ 90/108 m³/hr 50/60 Hz vacuum pump ▶ Xilog Maestro and Telesolve software 	<ul style="list-style-type: none"> ▶ Remote control for machine controls ▶ 7,5 kW electrospindle with TR10 tool changer ▶ F7 boring head ▶ no. 2 electronic detecting systems ▶ Vacuum area for half or entire working length ▶ Optimised centralised exhaust outlet ▶ Automatic centralised lubrication ▶ 250/300 m³/hr 50/60 Hz vacuum pump ▶ Preset for second 250/300 m³/hr vacuum pump ▶ Xilog Maestro and Telesolve software 	<ul style="list-style-type: none"> ▶ 6,6 kW electrospindle with Tecpad control ▶ F7 boring head with inverter ▶ Centralised exhaust outlet ▶ Preset for heads with fixed mechanical coupling system ▶ Tool changer: TR8 for S12 • TR10 for S15 • TR12 for S18 • TR13 for S22-31 ▶ HE multifunction aluminium worktable ▶ 4 right rear stops for D field ▶ Machining on a single area ▶ Centralised lubrication with manual pump ▶ Presetting for up to 2 vacuum pumps ▶ Nesting rectangular module for Xilog Maestro ▶ Xilog Maestro and Telesolve software
“C” FULL OPTIONAL VERSION	<ul style="list-style-type: none"> ▶ Remote control for machine controls ▶ Optimised centralised exhaust outlet ▶ F12 boring head with inverter ▶ Device to increase the drilling pressure ▶ “Prisma 5” 5 axis head with water cooling group ▶ TR10 and R12 tool changers ▶ Automatic centralised lubrication ▶ Multifunction aluminium worktable ▶ 90/108 m³/hr 50/60 Hz vacuum pump ▶ Xilog Maestro and Telesolve software 	<ul style="list-style-type: none"> ▶ Remote control for machine controls ▶ Optimised centralised exhaust outlet ▶ F12 boring head with inverter ▶ 12 kW electrospindle with R8 and TR10 tool changers ▶ VECTOR AXIS with Penta Digital Control ▶ 2 outlets electrospindle for horizontal power routing ▶ Automatic centralised lubrication ▶ Multifunction aluminium worktable ▶ 3 stops for “A” field, 3 stops for “D” field ▶ 90/108 m³/hr 50/60 Hz vacuum pump ▶ Xilog Maestro and Telesolve software 	<ul style="list-style-type: none"> ▶ Remote control for machine controls ▶ 12 kW electrospindle with TR10 tool changer ▶ F12 boring head ▶ no. 2 electronic detecting systems ▶ Vacuum area for half or entire working area ▶ Optimised centralised exhaust outlet ▶ Automatic centralised lubrication ▶ 250/300 m³/hr 50/60 Hz vacuum pump ▶ Preset for second 250/300 m³/hr vacuum pump ▶ Xilog Maestro and Telesolve software 	
“D” DOORS APPLICATIONS / COMPLETE AUTOMATION		<ul style="list-style-type: none"> ▶ Remote control for machine controls ▶ Optimised centralised exhaust outlet ▶ F12 boring head with inverter ▶ 12 kW electrospindle with R8 tool changer ▶ Set up for angular heads with preloading ▶ 2 outlets electrospindle for horizontal power routing ▶ Automatic centralised lubrication ▶ Multifunction aluminium worktable ▶ 3 stops for “A” field, 3 stops for “D” field ▶ 90/108 m³/hr 50/60 Hz vacuum pump ▶ Xilog Maestro and Telesolve software 	<ul style="list-style-type: none"> ▶ Remote control for machine controls ▶ 12 kW electrospindle with TR10 tool changer ▶ F12 boring head ▶ no. 2 electronic detecting systems ▶ Vacuum area for half or entire working area ▶ Optimised centralised exhaust outlet ▶ Automatic centralised lubrication ▶ 250/300 m³/hr 50/60 Hz vacuum pump ▶ Preset for second 250/300 m³/hr vacuum pump ▶ Automatic loading unit and workpiece outfeed belt ▶ Xilog Maestro and Telesolve software 	

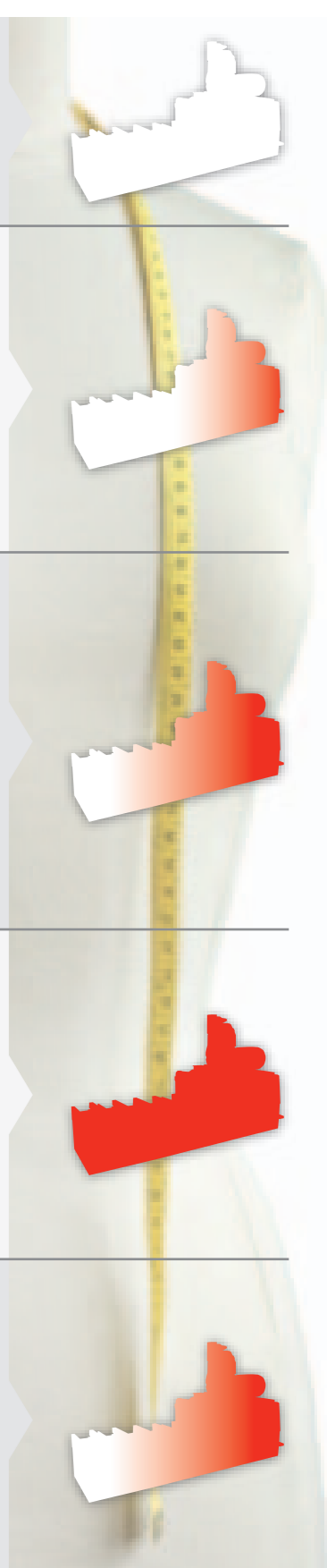

pratix

Overall dimensions and axes stroke.

pratix z5 ▶

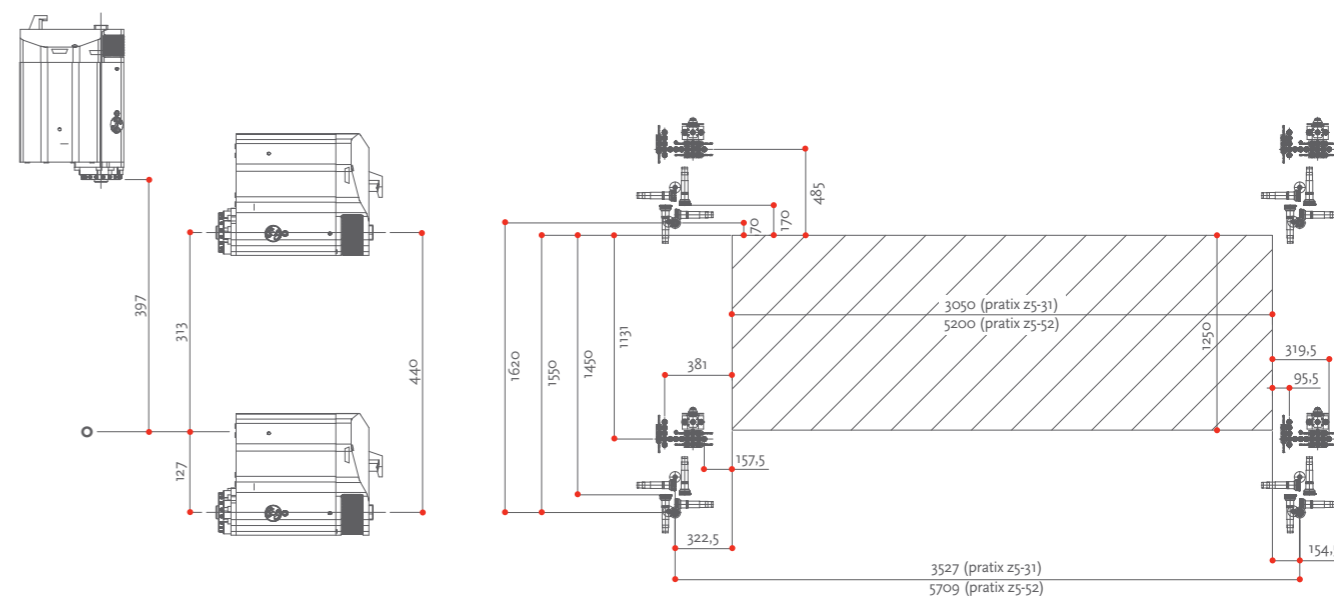
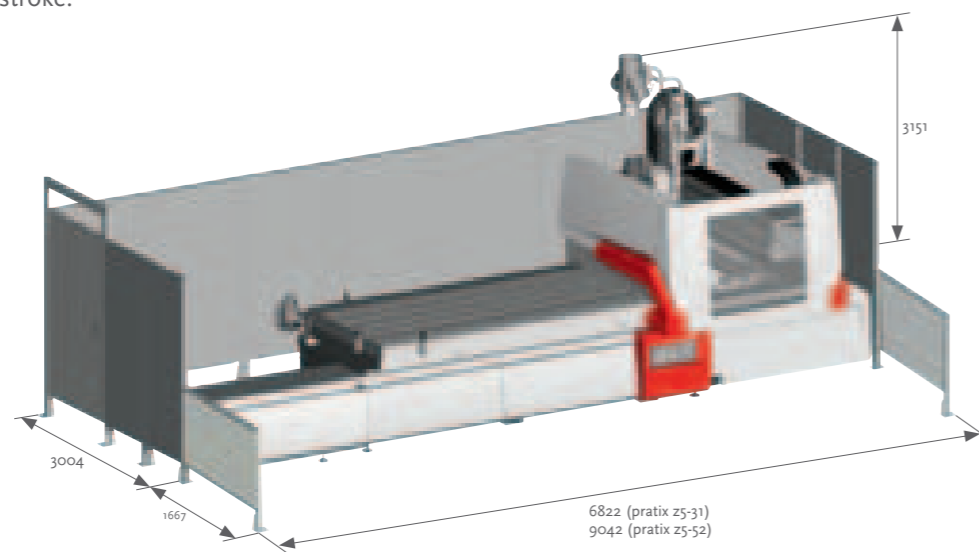

pratix z2 ▶

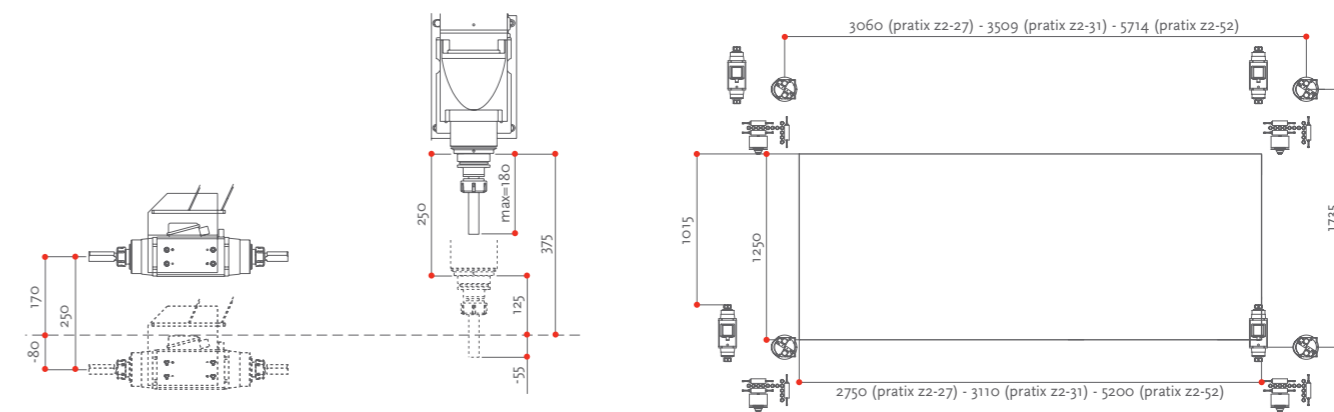
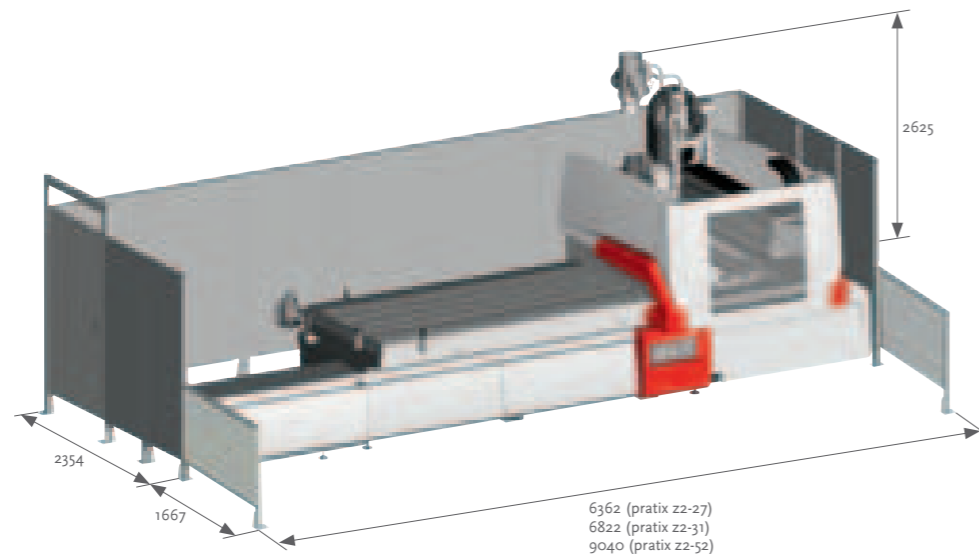

pratix s ▶

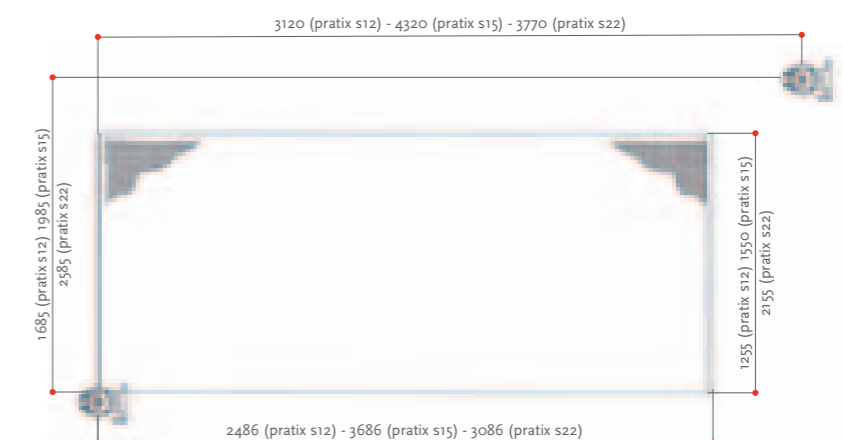
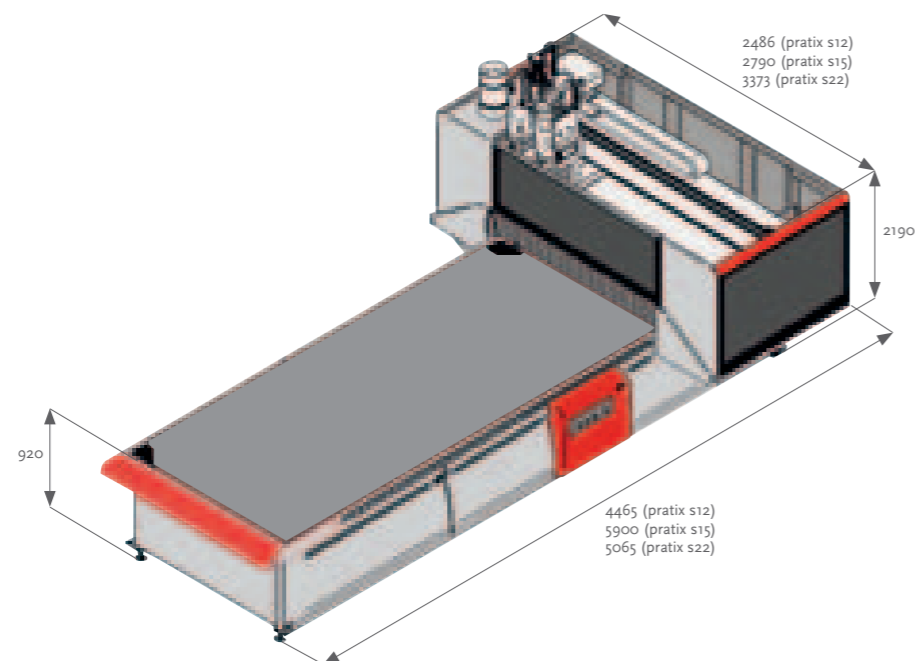

pratix

Overall dimensions and axes stroke.

pratix n ▼

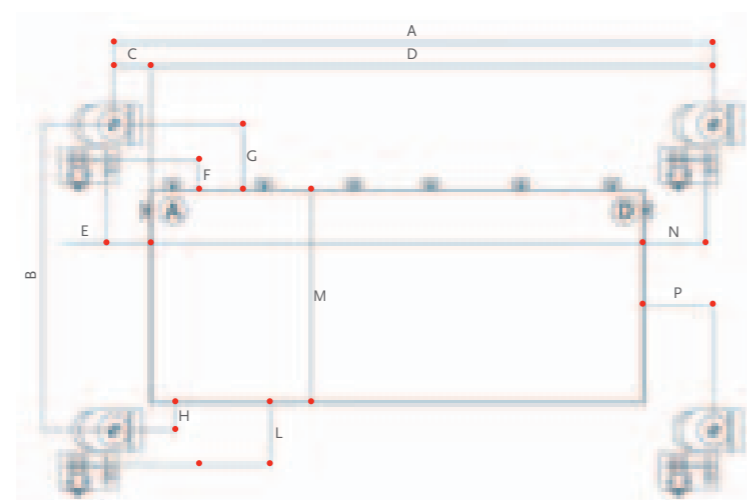
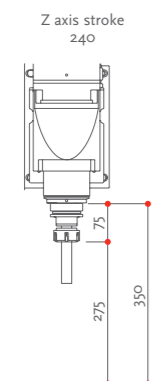
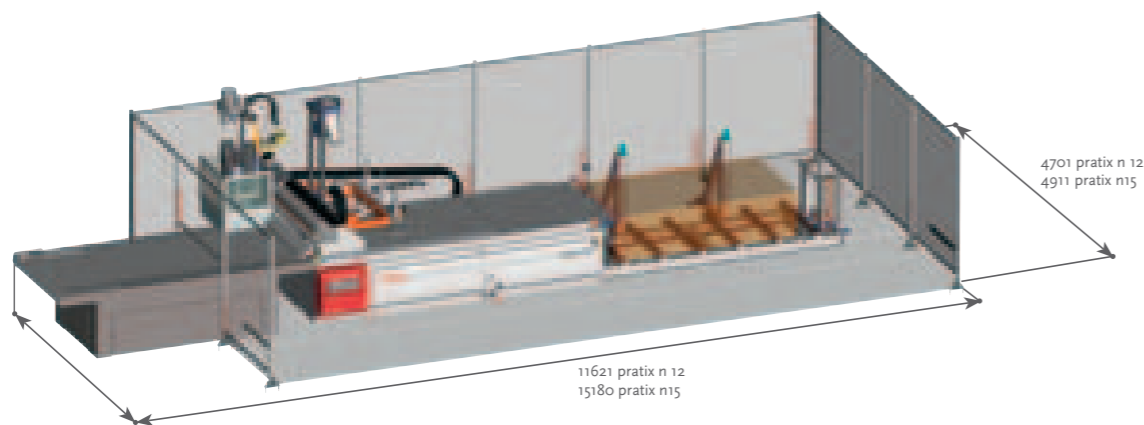
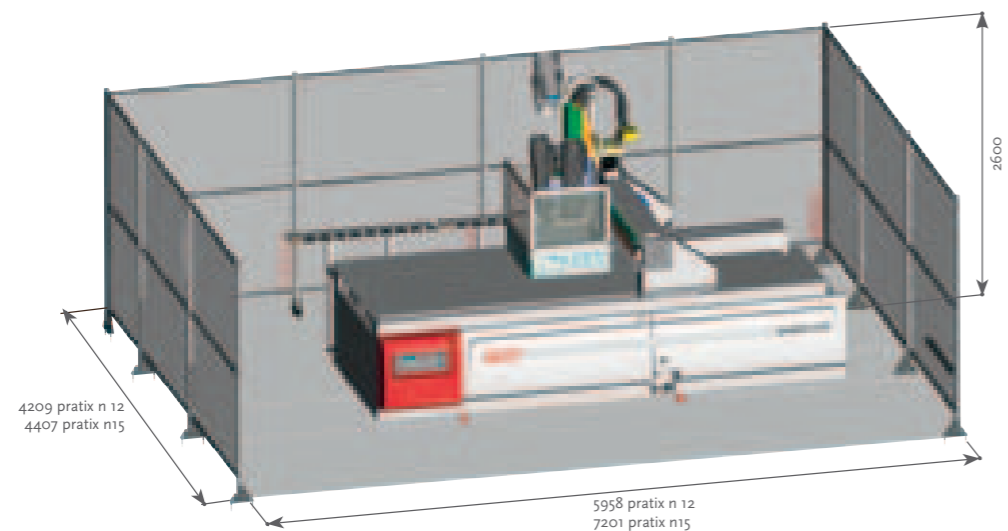

WORKING AREA		A	B	C	D	E	F	G	H	L	M	N	P
pratix n12	mm	3035	1745	263,5	2771,5	304,5	262,5	458,5	66,5	262,5	1220	290,5	331,5
pratix n15	mm	4271	1996	272	3999	313	259	423	53	217	1520	298	339

- scm**
- minimax**
- scm tecmatic**
- scm**
- routech**
- celaschi**
- dmc**
- superfici**
- sergiani**
- gabbiani**
- morbidelli**
- mahros**
- stefani**
- cpc**
- sag**
- scmgroup**
engineering
- delmac**
engineering
- scmfonderie**
- steelmec**
- hiteco**
- es**
- csr**
- CMS Cms**
wood technology
- CMS Cms**
advanced materials technology
- CMS Brembana**
stone technology
- CMS Brembana**
glass technology
- CMS CmsPlast**
plastic technology
- CMS Tecnocut**
waterjet technology
- CMS Balestrini**

- 1 large integrated group
- 18 production sites
- 29 specialist brands
- 21 foreign branches
- more than 50 years in business
- 70% exports
- 350 agents and distributors
- 365 registered patents
- 500 engineers
- 3.000 square metres showroom
- 10.000 classical and professional machines manufactured per year
- 240.000 square metres of production space

scmgroup
passion**technology**performance



www.scmgroup.com/qrcode/v1/



www.scmgroup.com/it/mission_scm

SINCERT



The technical data can vary according to the requested machine composition. In this catalogue, machines are shown with options. The company reserves the right to modify technical specifications without prior notice; the modifications do not influence the safety foreseen by the CE Norms.