











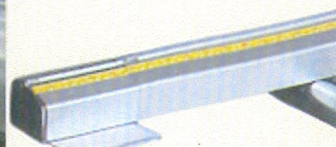
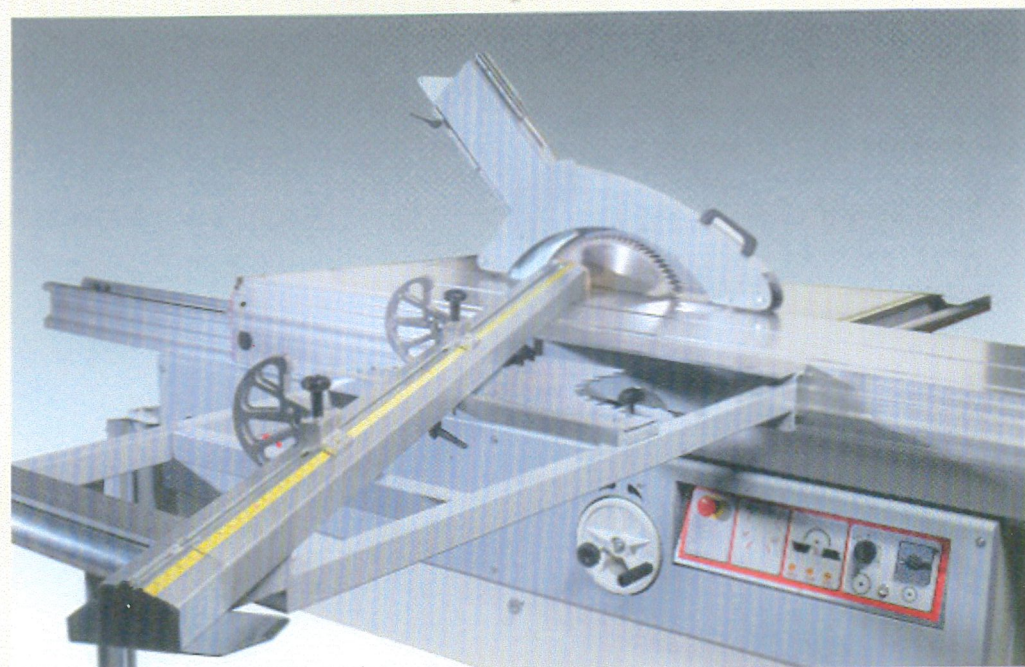

BOOM 3200

-  Sega circolare squadratrice con lama inclinabile e gruppo incisore
-  Squaring circular saw with tilting blade and scoring unit
-  Formatkreissäge mit schwenkbarem Sägeblatt und Vorritzer
-  Scie circulaire équadrisseuse avec lame inclinable et groupe inciseur
-  Sierra circular escuadradora con disco inclinable y conjunto incisor
-  Циркулярная кромкообрабатывающая пила с наклоняемым полотном и вырезающим устройством





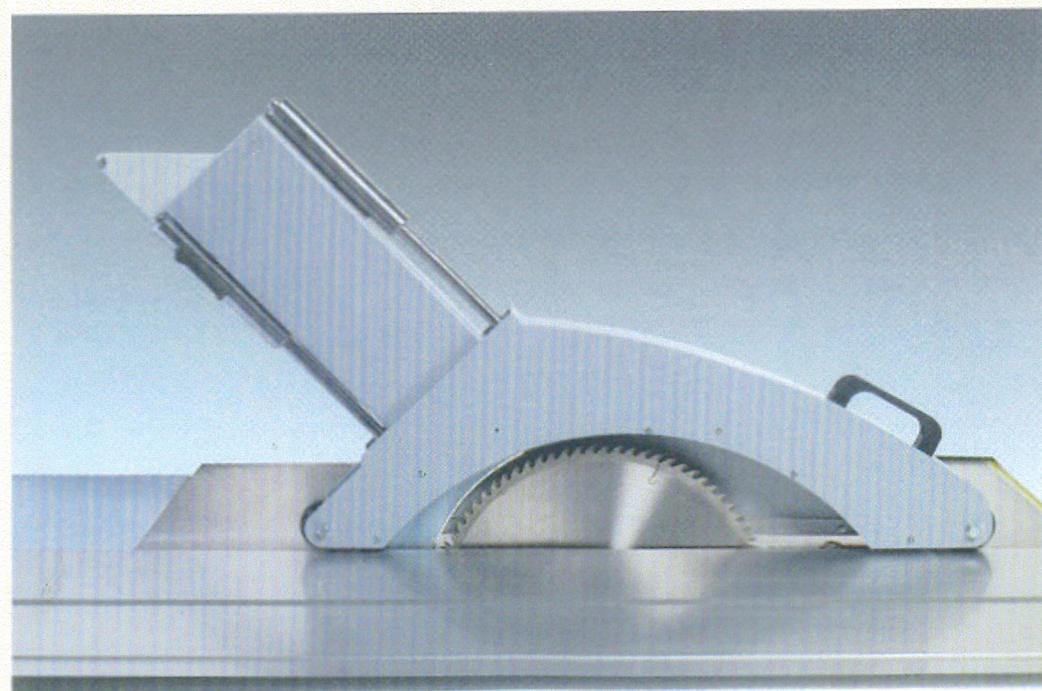



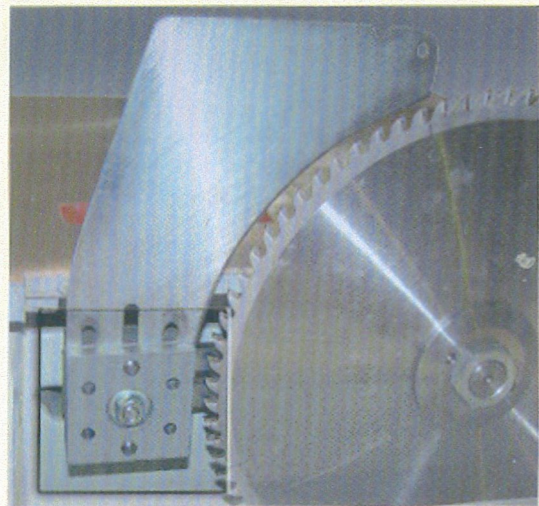





-  Posizionamento rapido inclinazione squadra a 90° - 15° - 22,5° - 30° - 45°
-  Quick adjustment of square fence at 90° - 15° - 22,5° - 30° - 45°
-  Anschlagsschnellpositionierung 90° - 15° - 22,5° - 30° - 45°
-  Reglage rapide inclination equerre 90° - 15° - 22,5° - 30° - 45°
-  Posicionamiento rapido inclinacion escuadra 90° - 15° - 22,5° - 30° - 45°
-  Быстрая установка наклона угольника на 90° - 15° - 22,5° - 30° - 45°



-  Estetica e funzionalità
-  Good looks and function
-  Ästhetik und Funktions
-  L'esthétique et la fonction
-  Estética y funcionalidad
-  Красота и функциональность







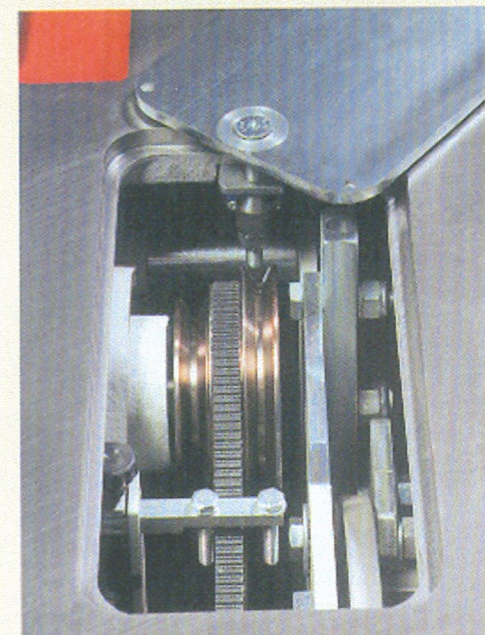

-  Coltello divisore regolabile
-  Adjustable riving knife.
-  Verstellbares Spaltkeil
-  Couteau diviseur réglable.
-  Cuchilla divisora regulable.
-  Регулируемый делительный нож
-  Esclusione rapida d
-  Rapid disengagem
-  Schnellausschließu
-  Exclusion rapide du
-  Exclusión rápida de
-  Быстрое удаление

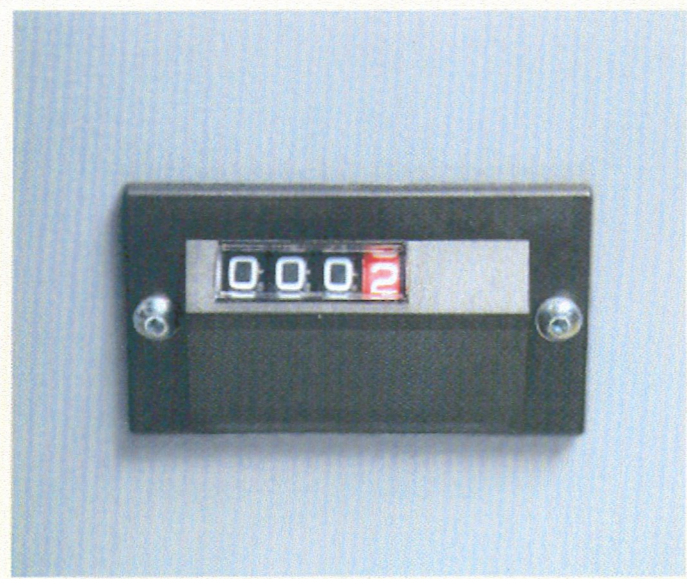
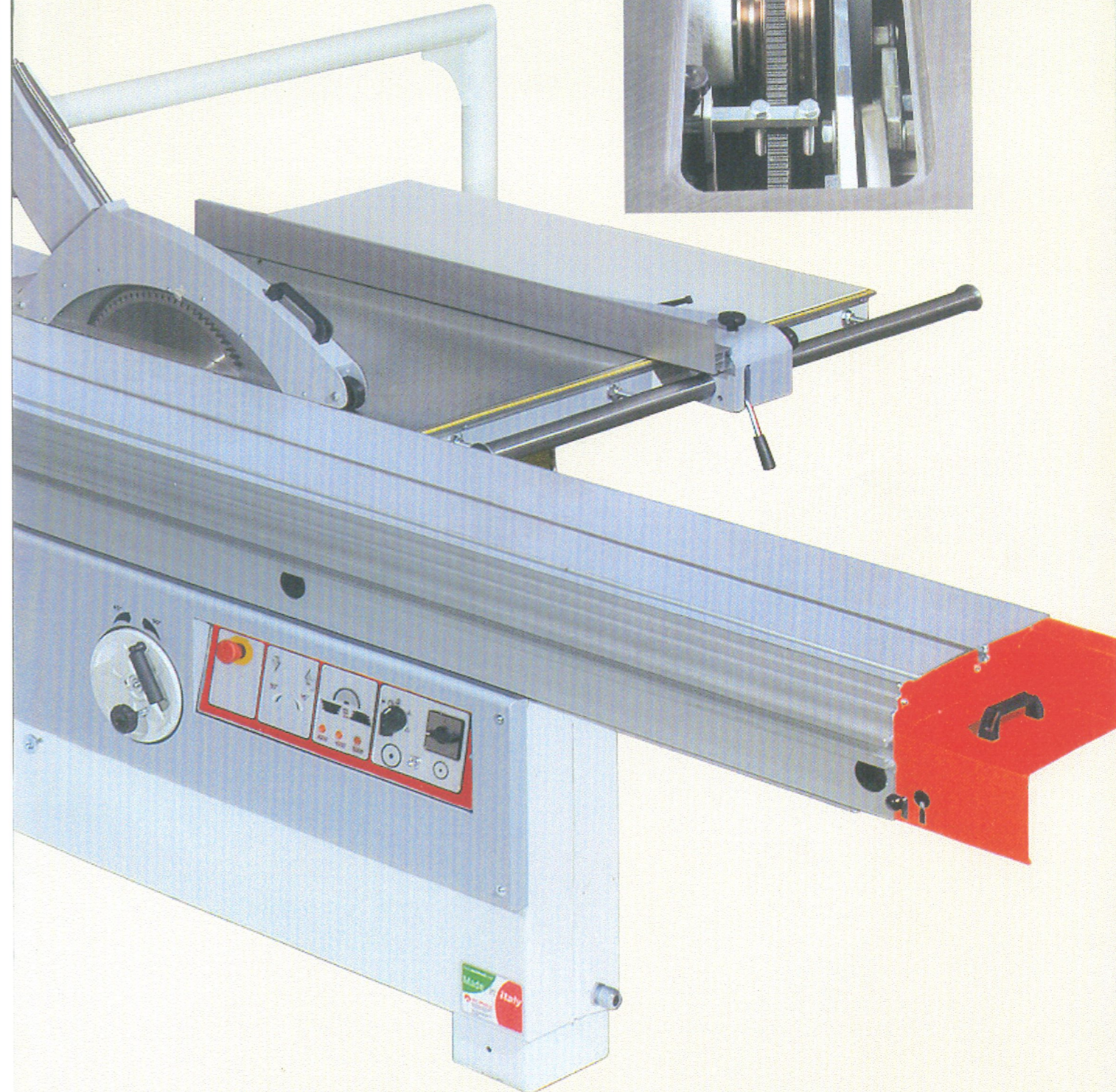
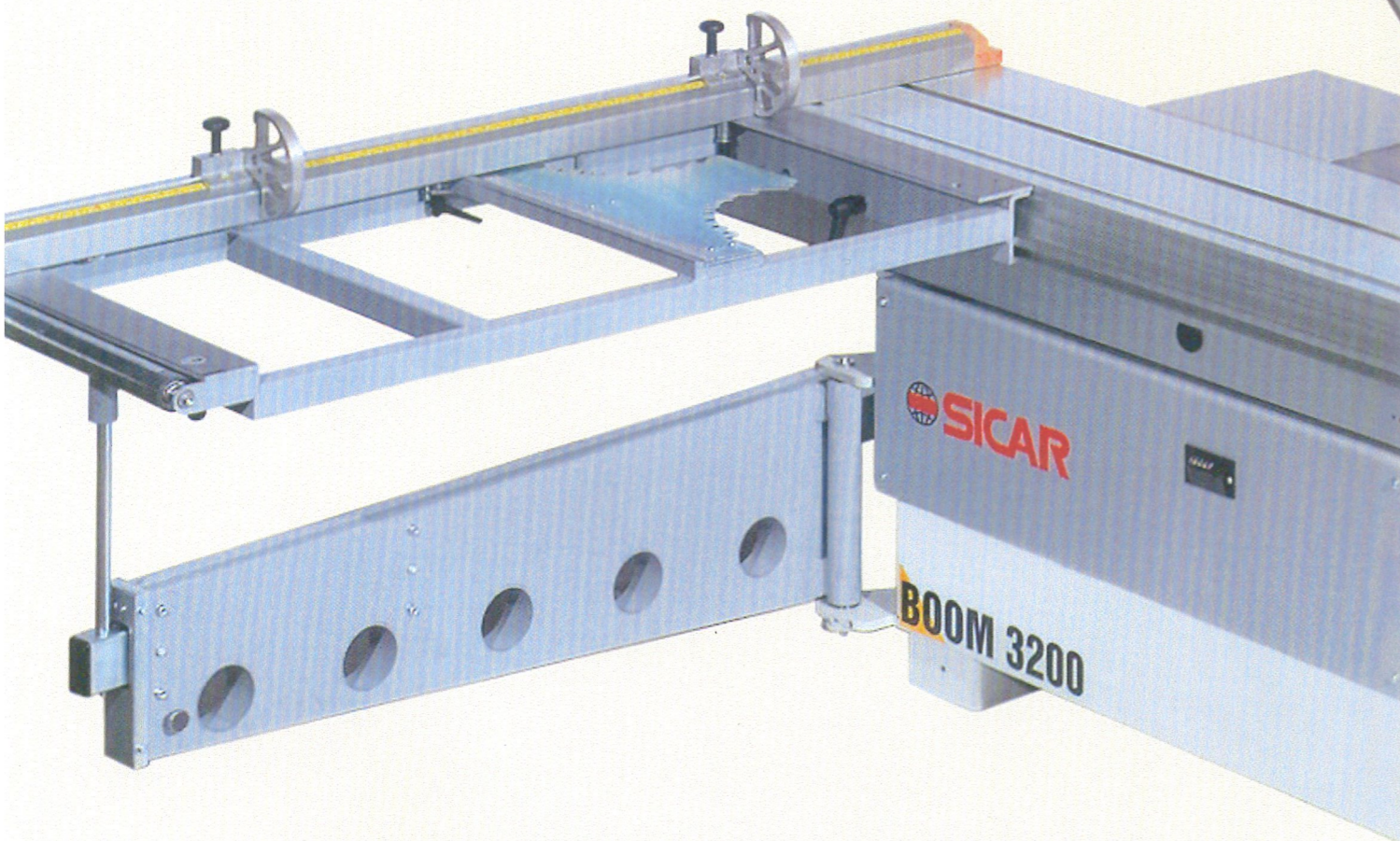
el paralelogramma dal piano di lavoro
 nt of the parallelogram from the worktable
 ng des Parallelogramms aus dem Arbeitstisch
 parallélogramme de la table de travail.
 paralelogramo de la mesa de trabajo
 параллелограмма с рабочей поверхности



-  Cambio ra
-  sopra il pia
-  Quick spee
-  the table
-  Schnelle
-  Geschwind
-  Changeme
-  vitesse sur
-  Cambio rap
-  Быстрая за
-  верхней час



-  Numeratore mec
-  Mechanical disp
-  Mechanisches S
-  Numérateur mec
-  Numerador mec
-  Механический ну







canico per inclinazione gruppo lama ed incisore 90° - 45°
 ay for tilting the blade and scorer unit at 90° - 45°
 ichtgerät für die Schrägstellung des Sägeblatt- Vorritzaggregats auf 90° - 45°.
 anique pour l'inclinaison du groupe lame et inciseur à 90° - 45°
 inico para la inclinación del grupo hoja e incisor a 90° - 45°
 ератор для наклона блока полотна и вырезающего устройства под углом 90° - 45°

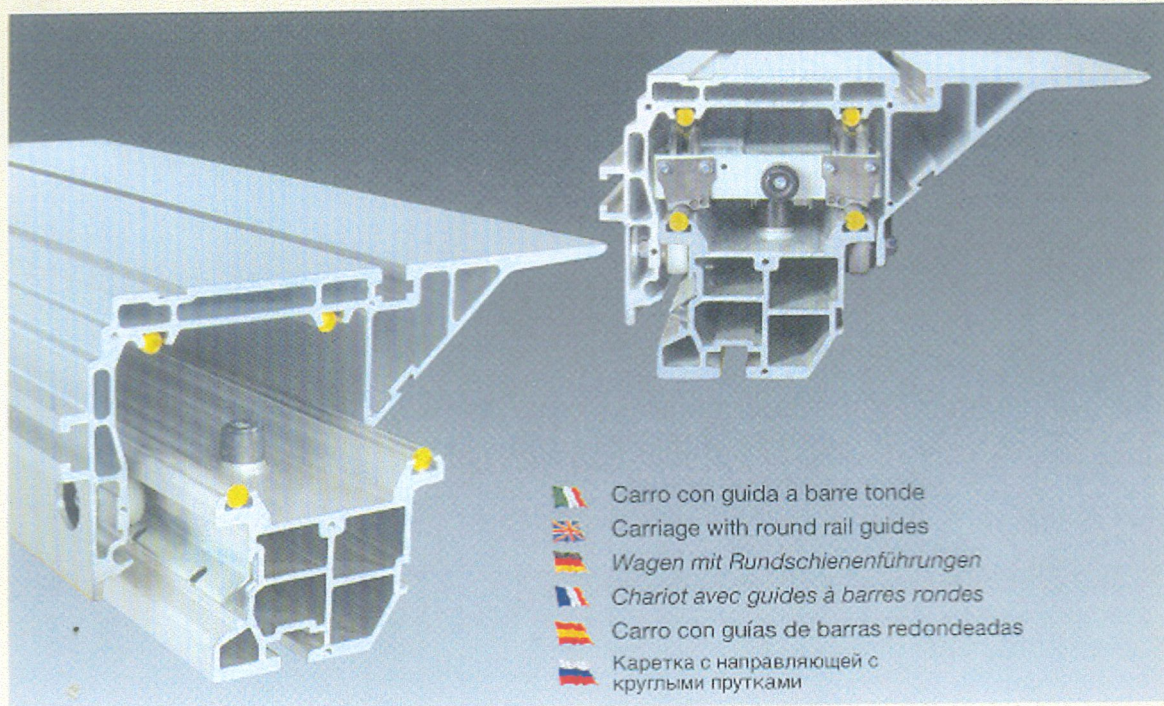





ite ad una elevata sicurezza
 al features combined with high safety standards
 chtigkeit vereint mit großer Sicherheit.
 inalité alliées à un niveau élevé de sécurité.
 umadas a una elevada seguridad colocarse
 ть сочетаются с повышенной безопасностью

Ri
 Sch
 Régl
 Ri
 Регулируемая линейка-уг







rapido velocità da
 to
 ed change from
 Änderung der
 igkeit
 nt rapide de
 la table
 ido velocidad
 ена скорости с
 ти поверхности

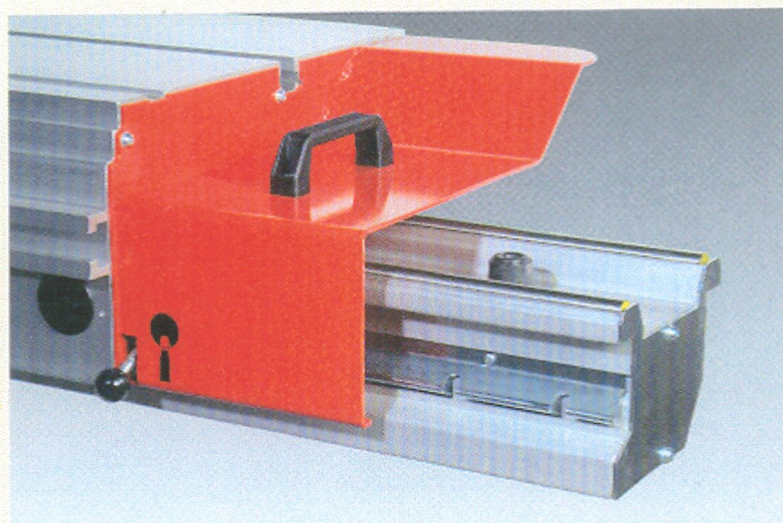

-  Carro con guida a barre tonde
-  Carriage with round rail guides
-  Wagen mit Rundschienenführungen
-  Chariot avec guides à barres rondes
-  Carro con guías de barras redondeadas
-  Каретка с направляющей с круглыми прутками

Il carro dispone di un bloccaggio che si può 
 inserire in qualsiasi posizione
The carriage features a locking device that 
can be engaged in any position
 Der Wagen verfügt über eine Blockierung, die 
 in jeder Position aktiviert werden kann.
Le chariot est équipé d'un verrouillage que 
l'on peut utiliser à n'importe quelle position
 El carro dispone de un bloqueo que puede 
 en cualquier posición
 Каретка оборудована блокировкой, которую 
 можно включить в любом положении.



a squadro orientabile (optional) 
Adjustable fence rule (optional) 
 renkbares Anschlaglineal (Option) 
petite équerre orientable (option) 
 gla escuadra orientable (opcional) 
 льник (по дополнительному заказу) 

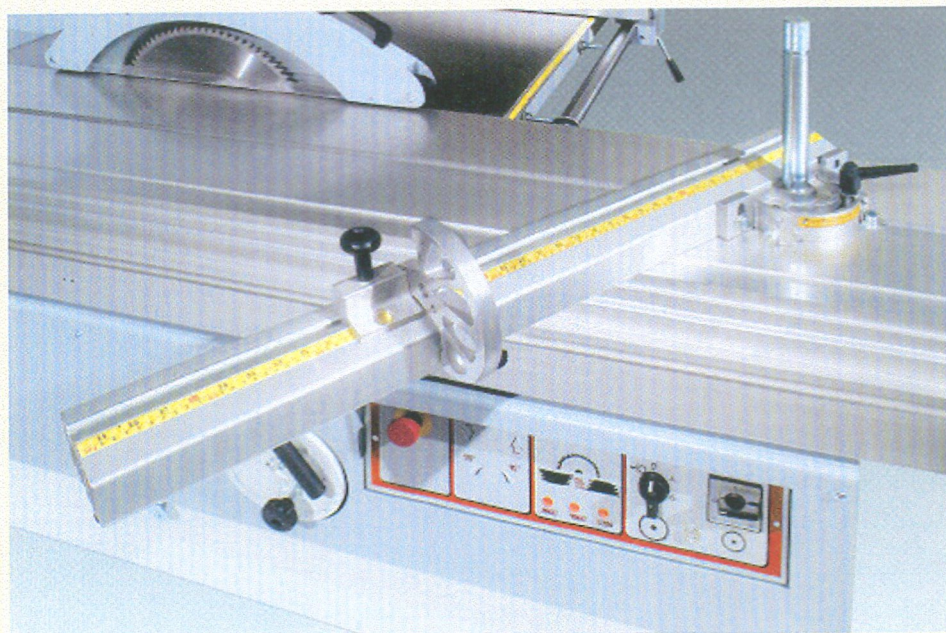

BOOM 3200

CARATTERISTICHE TECNICHE		CE	EXTRA-CE
Diámetro lama	mm	300/350/400	300/350/400
Diámetro árbol lama	mm	30	30
Altezza max. di taglio a 90°	m/min	75/100/125	75/100/125
Inclinazione max. della lama		45°	45°
Altezza max. di taglio a 45°	mm	54-72-90	54-72-90
Velocità árbol lama	g/1'	3000/4000/5000	3000/4000/5000
Diámetro incisor	mm	125/120/100	125/120/100
Diámetro árbol incisor	mm	20/22	20/22
Altezza max. taglio incisor a 90°	mm	5	5
Inclinazione max. incisor		45°	45°
Altezza max. taglio incisor a 45°	mm	3,5	3,5
Velocità árbol incisor	g/1'	8000	8000
Potenza motore incisor	HP/KW	1 - 0,75	1 - 0,75
Dimensioni piano fisso	mm	660x1100	660x1100
Altezza piano da terra	mm	910	910
Dimensioni carro	mm	410x3200	410x3200
Lunghezza max. di squadratura della lama	mm	3200	3200
Lunghezza max. di taglio fra lama e guida	mm	1300	1300
Lunghezza max. di squadratura dal incisor	mm	3200	3200
Diámetro del bocchettone di aspirazione	mm	120	120
Peso netto	kg	780	785
Potenza motore	HP/KW	5,5 - 4	5,5 - 4
Chiavi di servizio		•	•

ACCESSORI STANDARD	CE	EXTRA-CE
Sega e incisor inclinabili	•	•
Carrello in alluminio	•	•
Pressore ad eccentrico	•	•
Protezioni antirfortunistiche	•	•
Protezioni parallelogramma	•	•
Bloccaggio carro in tutte le posizioni	•	•
Piano appoggio posteriore	•	•
Piano appoggio laterale	•	•

ACCESSORI OPTIONAL	CE	EXTRA-CE
Motore	HP/KW	10/7,5
Visualizzatore di velocità luminoso	•	•

TECHNICAL DATA		CE	EXTRA-CE
Blade diameter	mm	300/350/400	300/350/400
Blade shaft diameter	mm	30	30
Max cutting height at 90°	m/min	75/100/125	75/100/125
Max blade tilting		45°	45°
Max cutting height at 45°	mm	54-72-90	54-72-90
Blade shaft speeds	g/1'	3000/4000/5000	3000/4000/5000
Diameter of scoring saw	mm	125/120/100	125/120/100
Diameter of scoring shaft	mm	20/22	20/22
Max cutting height of scoring blade at 90°	mm	5	5
Max tilting of scoring table		45°	45°
Max cutting height of scoring blade at 45°	mm	3,5	3,5
Scoring shaft speeds	g/1'	8000	8000
Scoring motor power	HP/KW	1 - 0,75	1 - 0,75
Size of fixed table	mm	660x1100	660x1100
Table height	mm	910	910
Size of sliding table	mm	410x3200	410x3200
Max squaring-off length to the blade	mm	3200	3200
Max cutting width between blade and fence	mm	1300	1300
Max squaring-off length from scoring blade	mm	3200	3200
Diameter of suction outlet	mm	120	120
Net weight	kg	780	785
Motor power	HP/KW	5,5 - 4	5,5 - 4
Service wrenches		•	•

STANDARD ACCESSORIES	CE	EXTRA-CE
Tilting main saw and scoring saw	•	•
Aluminium sliding table	•	•
Eccentric clamp	•	•
Safety guard for accident prevention	•	•
Parallelogram-type guard	•	•
Carriage can be locked in any position	•	•
Rear support surface	•	•
Side support surface	•	•

OPTIONAL ACCESSORIES	CE	EXTRA-CE
Motor	HP/KW	10/7,5
LED speed display	•	•

TECHNISCHE DATEN		CE	EXTRA-CE
Durchmesser Sägeblatt	mm	300/350/400	300/350/400
Durchmesser Sägewell	mm	30	30
Max. Schnitthöhe bei 90°	m/min	75/100/125	75/100/125
Max. Messerschnittwinkel		45°	45°
Max. Schnitthöhe bei 45°	mm	54-72-90	54-72-90
Drehzahl Sägewelle	g/1'	3000/4000/5000	3000/4000/5000
Vorritzerdurchmesser	mm	125/120/100	125/120/100
Durchmesser Vorritzerwelle	mm	20/22	20/22
Max. vorritzhöhe bei 90°	mm	5	5
Max. vorritzwinkel		45°	45°
Max. vorritzhöhe bei 45°	mm	3,5	3,5
Drehzahl Vorritzerwelle	g/1'	8000	8000
Leistung Vorritzermotor	HP/KW	1 - 0,75	1 - 0,75
Abmessungen fester Tisch	mm	660x1100	660x1100
Tisch bodenhöhe	mm	910	910
Schlitzenabmessungen	mm	410x3200	410x3200
Max. Formatschnittlänge am Sägeblatt	mm	3200	3200
Max. Schnittlänge Sägeblatt-Führung	mm	1300	1300
Max. Formatschnittlänge Vorritzerwelle	mm	3200	3200
Durchmesser/Abstützungen	mm	120	120
Gewicht Netto	kg	780	785
Motorleistung	HP/KW	5,5 - 4	5,5 - 4
Betriebschlüssel		•	•

STANDARD ZUBEHÖR	CE	EXTRA-CE
Schwerkbares Säge- und Vorritzaggregate	•	•
Alu-Schlitzen	•	•
Exzenterandrücker	•	•
Unfallschutzvorrichtungen	•	•
Parallelogrammschutz	•	•
Schlitzenarretierung in jeder Position	•	•
Hinterer Auflagetisch	•	•
Seitlicher Auflagetisch	•	•

ZUBEHÖR AUF VERLANGEN	CE	EXTRA-CE
Motor	HP/KW	10/7,5
Drehzahl-Display	•	•

DONNÉES TECHNIQUES		CE	EXTRA-CE
Diámetro de la lama	mm	300/350/400	300/350/400
Diámetro de árbol de la lama	mm	30	30
Hauteur maxi de coupe à 90°	m/min	75/100/125	75/100/125
Inclinación max. de la lama		45°	45°
Hauteur maxi de coupe à 45°	mm	54-72-90	54-72-90
Vitesse de l'arbre de la lame	g/1'	3000/4000/5000	3000/4000/5000
Diámetro de l'incisor	mm	125/120/100	125/120/100
Diámetro de l'arbre de l'incisor	mm	20/22	20/22
Hauteur maxi de coupe de l'incisor à 90°	mm	5	5
Inclinación max. de l'incisor		45°	45°
Hauteur maxi de coupe de l'incisor à 45°	mm	3,5	3,5
Vitesse de l'arbre de l'incisor	g/1'	8000	8000
Puissance du moteur de l'incisor	HP/KW	1 - 0,75	1 - 0,75
Dimensions de la table fixe	mm	660x1100	660x1100
Hauteur de la table	mm	910	910
Dimensions du chariot	mm	410x3200	410x3200
Longueur max. d'équilibrage à la lame	mm	3200	3200
Largueur max. de coupe entre la lame et le guide	mm	1300	1300
Longueur max. d'équilibrage à partir de l'incisor	mm	3200	3200
Canne de l'embout d'aspiration	mm	120	120
Poids net	kg	780	785
Puissance du moteur	HP/KW	5,5 - 4	5,5 - 4
Cles de service		•	•

ACCESSOIRES STANDARD	CE	EXTRA-CE
Scie et incisor inclinables	•	•
Chariot en aluminium	•	•
Pressore excentrique	•	•
Protections contre les accidents	•	•
Protections parallélogramme	•	•
Bloccaggio chariot avec toutes les positions	•	•
Plan d'appui arrière	•	•
Plan d'appui latéral	•	•

ACCESSOIRES EN OPTION	CE	EXTRA-CE
Motor	HP/KW	10/7,5
Affichage lumineux de vitesse	•	•

