

Processing centres BMG 500/600



Be on the safe side with HOMAG

An investment in a new machine or plant should not be an experiment. Opt for a competent, experienced and reliable partner you can trust – opt for HOMAG.

- Competence and experience gathered over more than 50 years
- Production of over 1 500 processing centres a year throughout the HOMAG Group
- A motivated workforce of around 5,000 working to produce the legendary standard of HOMAG quality in 12 locations

High technology for woodworking shops and industrial producers:

- The unique basic machine construction made of the solid composite material SORB TECH guarantees optimum processing quality through vibration damping and extreme durability
- Different process technologies such as sawing, edge banding, hardware mounting, measurement processes and 3D processing can all be combined to ensure a truly future-proof investment

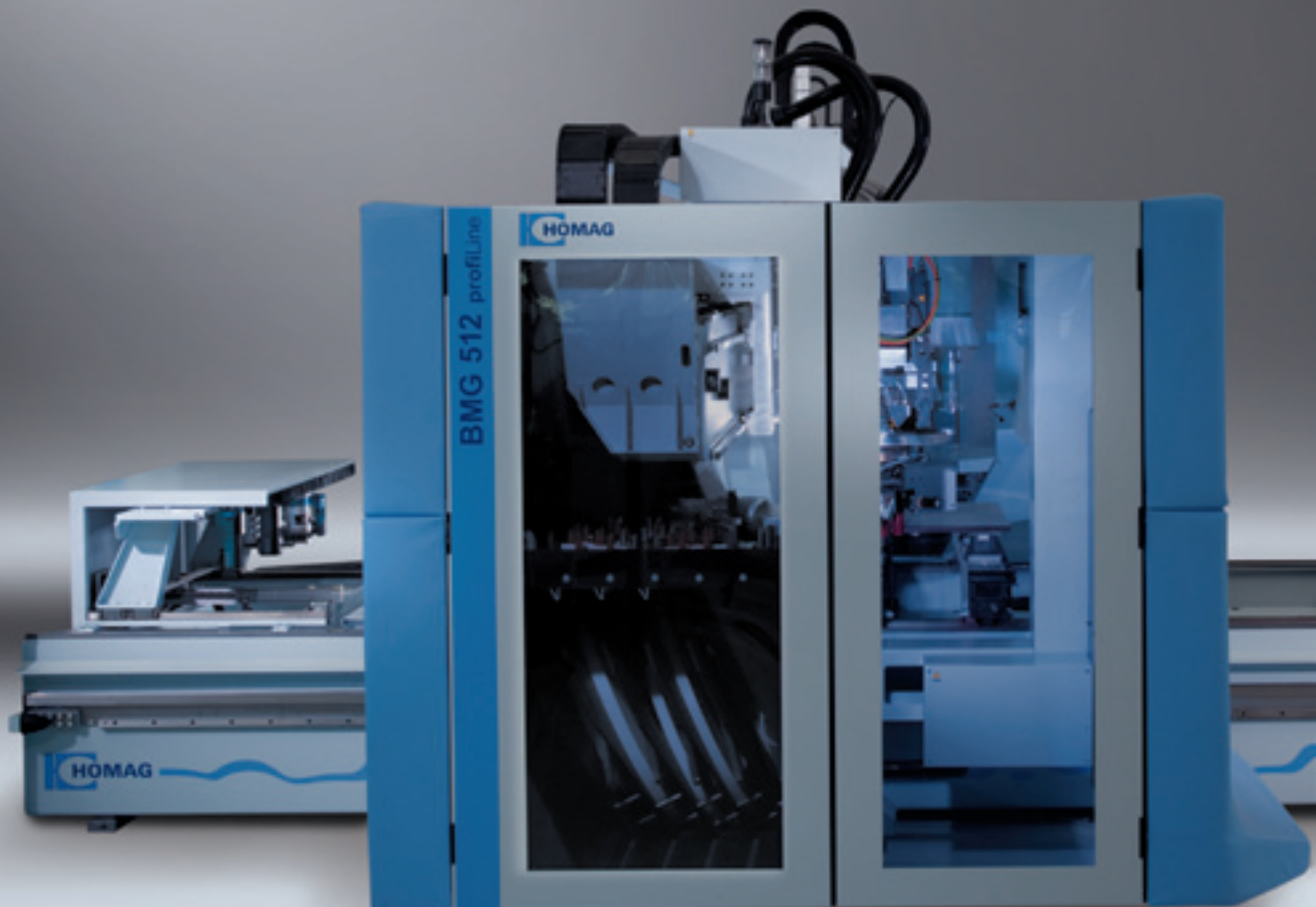



Precise shift cuts – extreme fitting accuracy from the word go, even with extreme material thicknesses.

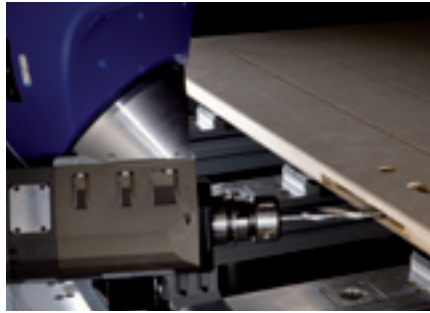

DRIVE5C+ five-axis spindle for fewer units and greater flexibility in the design of your products.



Edge banding to a previously unattainable standard of quality: HOMAG **laserTec** – the quantum leap for furniture production.

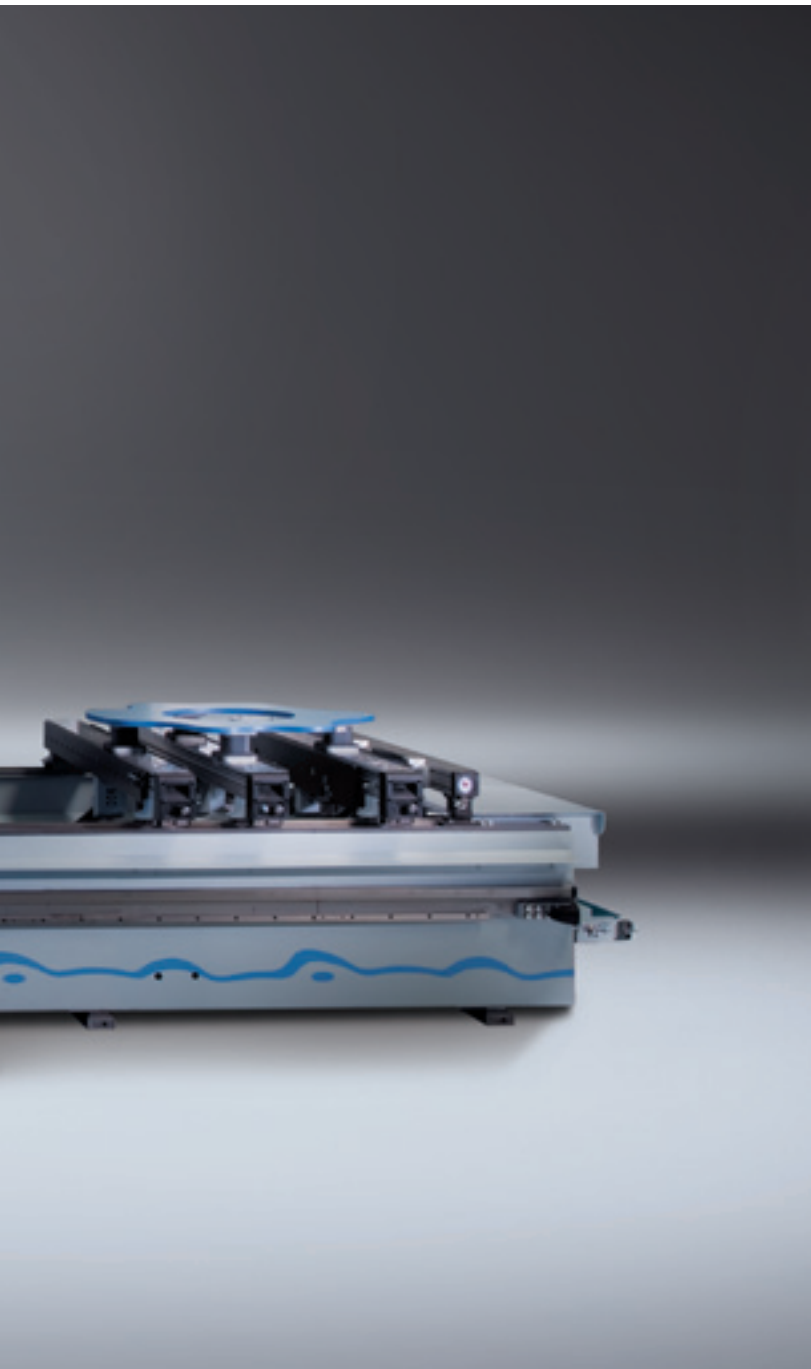

Content

08	BMG 500/600 – economy from the factory floor
10	As individual as your requirements
12	Versatility - productively manufactured
14	Scalable performance
16	Trimming spindles
18	Drilling systems to the highest standard
20	Tool changer
21	Units
22	Edge banding
24	Innovative edge banding technology for all
26	The console table
28	The AP automatic positioning table
29	The grid table
30	Special clamping devices
32	Automation
34	Software/control
36	Services
38	Technical data BMG 500/600

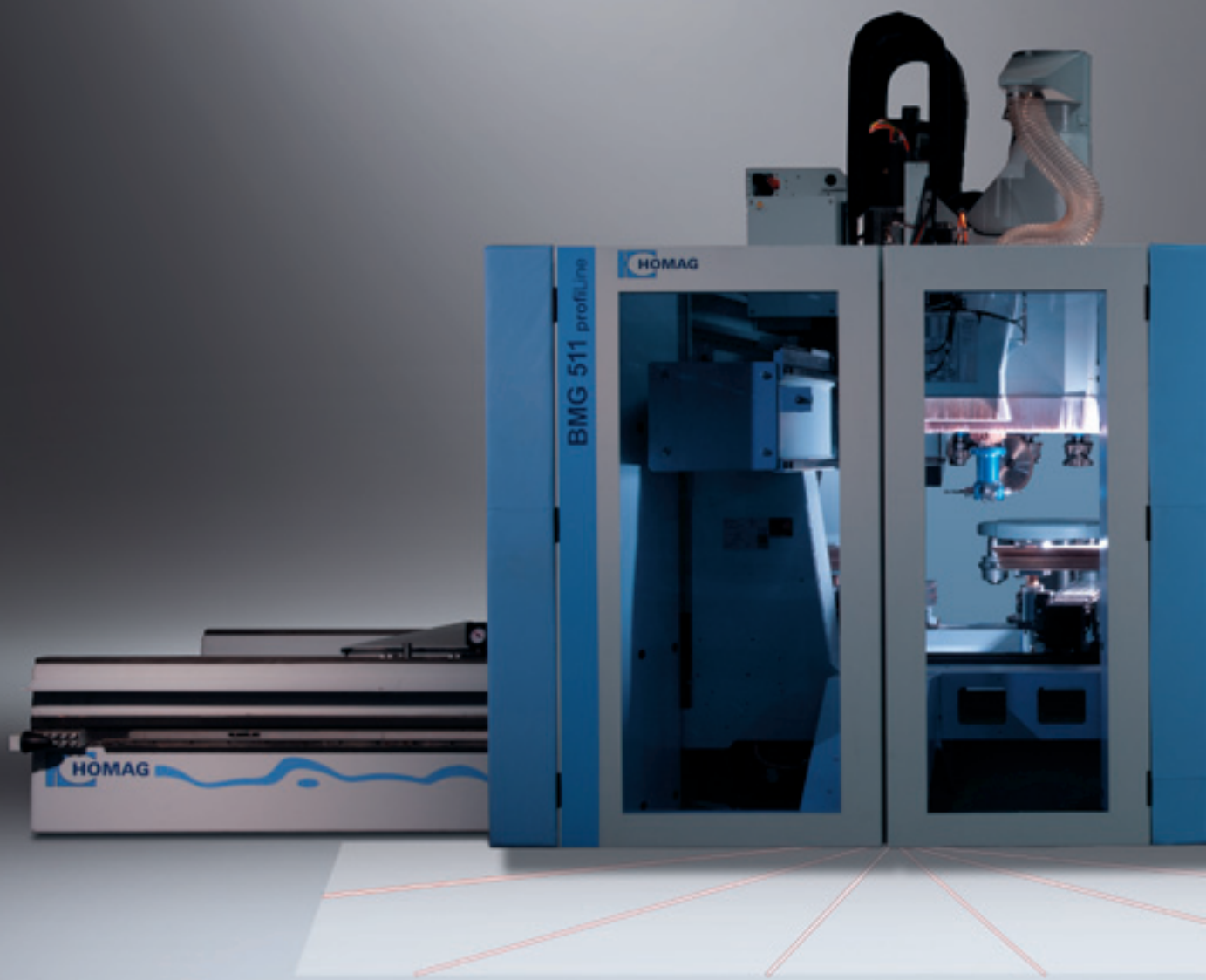

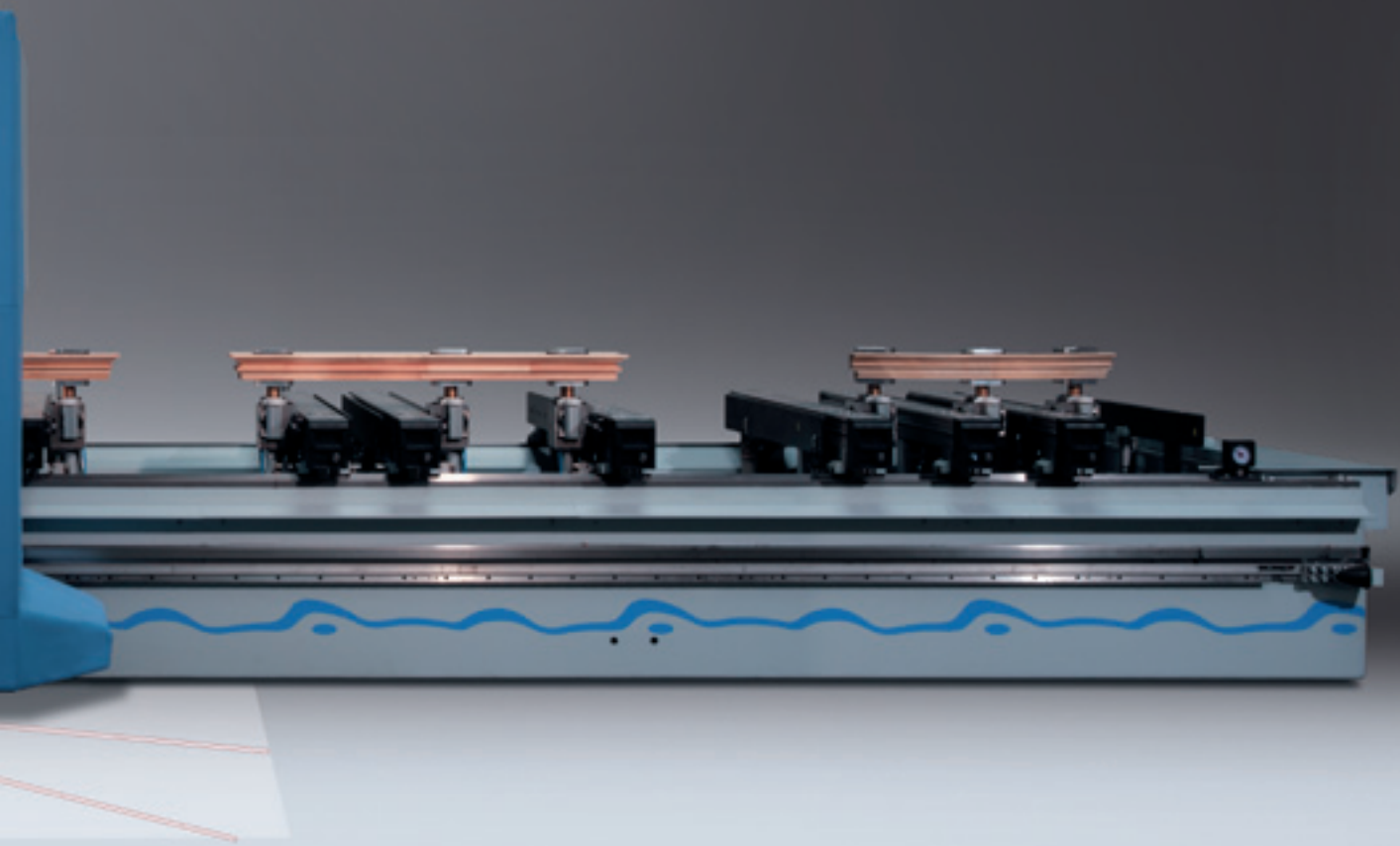

BMG512/M/A: 4- and 5 axis combination with automatic table for the production of doors and staircases



BMG611: High Z-axis and DRIVE5+ 5 axis-head with double side bearing for 3D parts processing up to 500 mm



BMG512/V: Processing center for edge banding of shaped parts with 2 independent Y-axes



BMG511/R: Processing center with aluminium matrix table for processing of technical components, shaped parts and Nesting

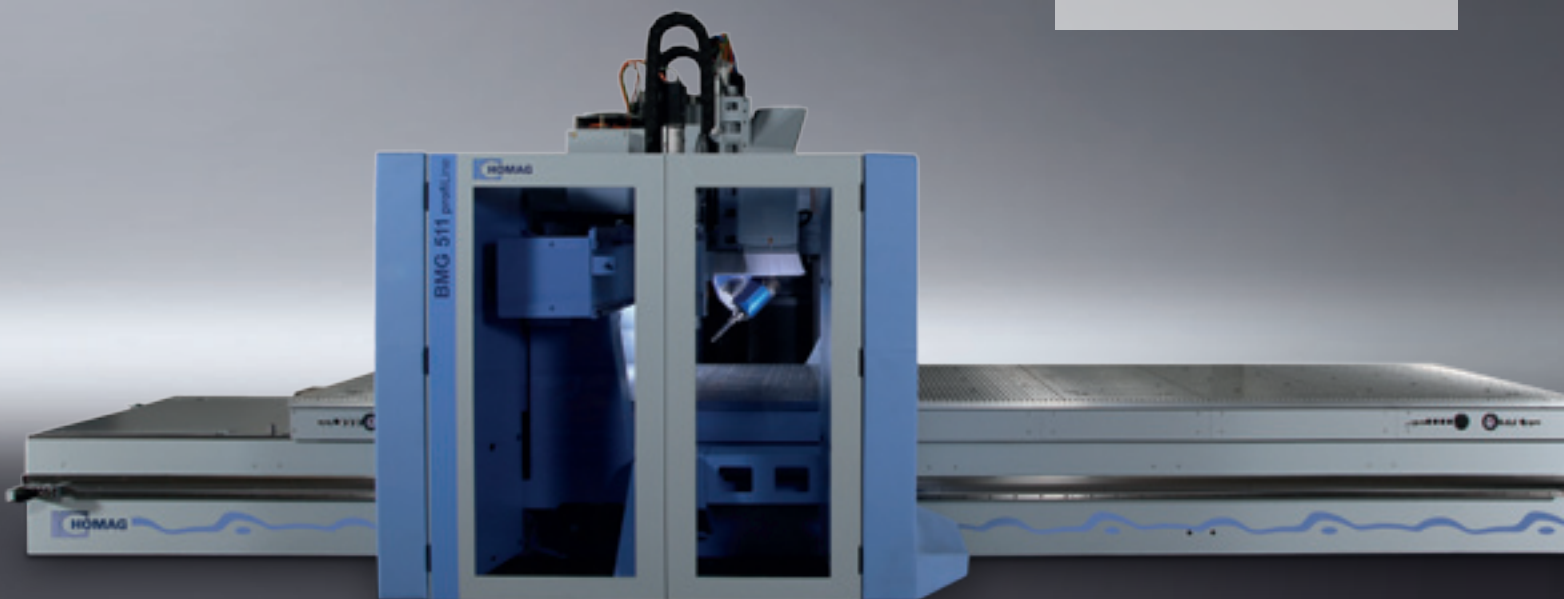

BMG 500/600 – Economy from the factory floor

Deciding in favour of a HOMAG machine means investing in a highly efficient processing centre with the capability to fulfil wide-ranging different manufacturing requirements.

Each machine is a complete system guaranteeing maximum output and efficiency every time – no matter how individual your production requirements are.

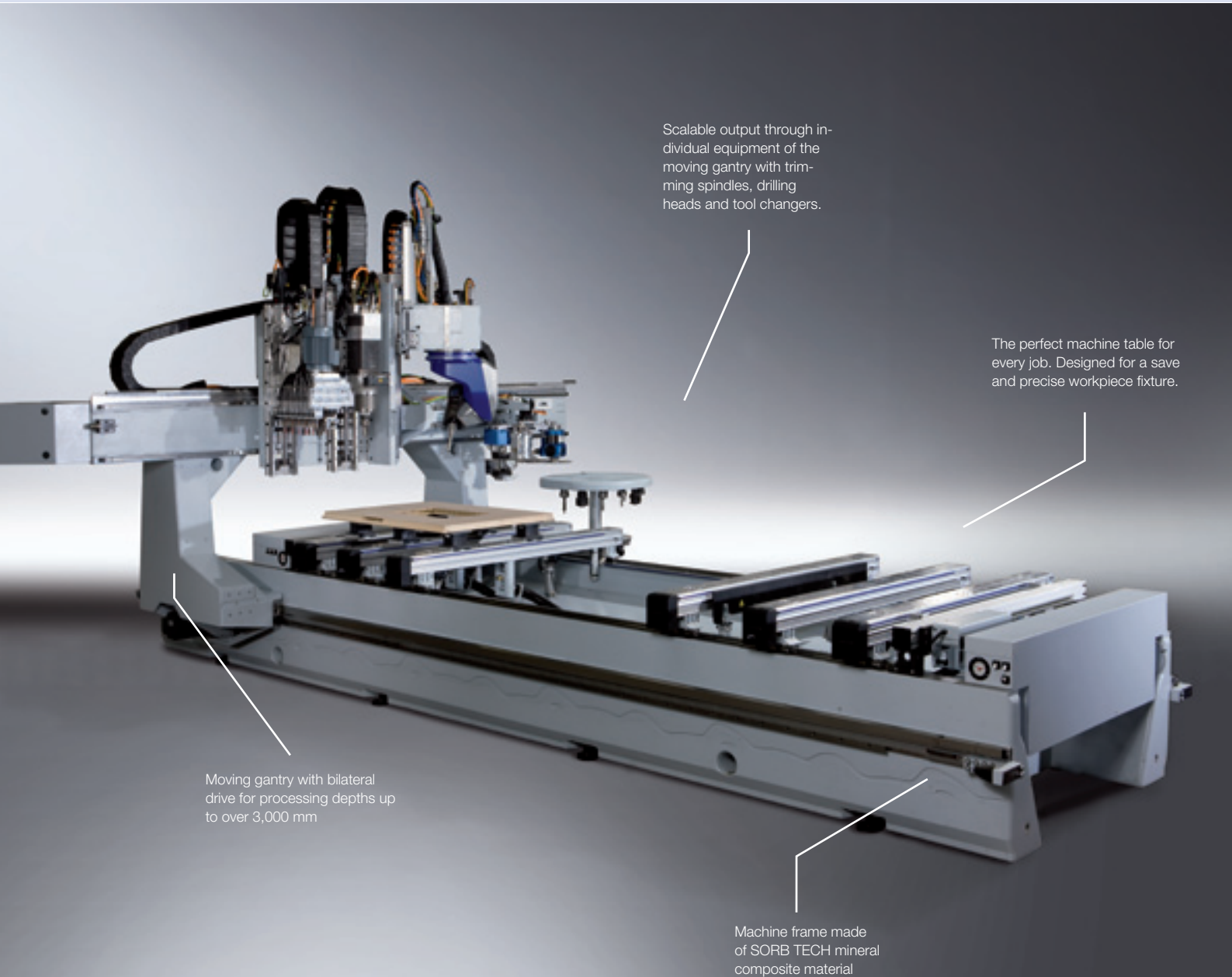

Scalable output through individual equipment of the moving gantry with trimming spindles, drilling heads and tool changers.

The perfect machine table for every job. Designed for a save and precise workpiece fixture.

Moving gantry with bilateral drive for processing depths up to over 3,000 mm

Machine frame made of SORB TECH mineral composite material

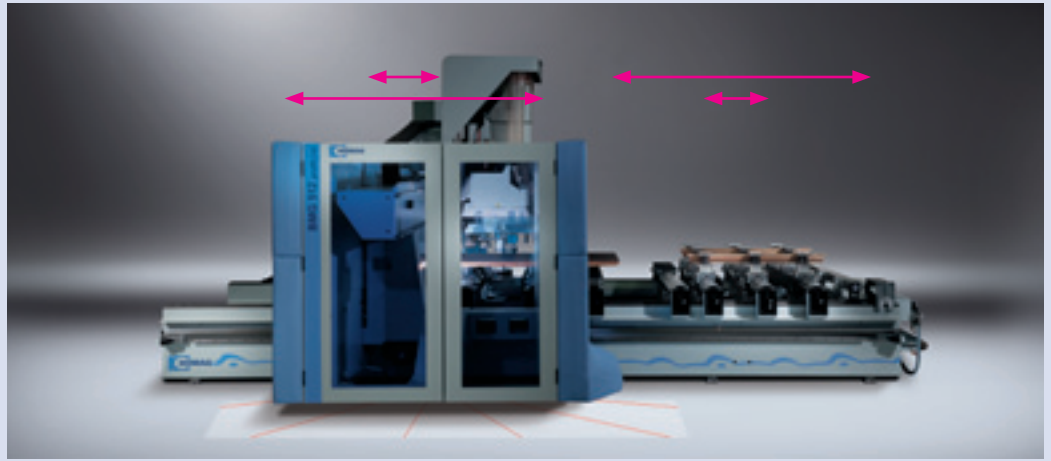

safeScan safety system

Two-step safety system (patented) with feed reduction in the warning area and stop on bumper contact. The no-contact monitoring system combines optimum working safety, simple access to the machine and high performance.

Dynamic alternating field size

The safety system allows a dynamic alternating field size without fixed field allocation. This means that when processing longer parts on one side of the machine, it is still possible to prepare and position a shorter part on the other side.

Block processing

Cubic workpieces of up to 300 mm (500 mm) in height can be processed by the large 600 mm (910 mm) axes, even when working with the maximum workpiece length of 230 mm (measured from the HSK support).

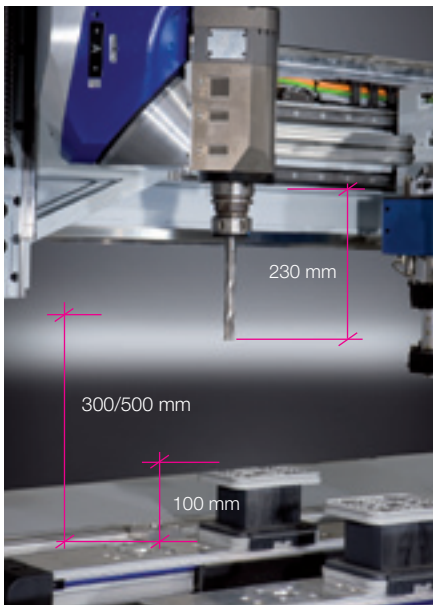

Protecting the environment and improving economy

A heavy-duty machine bed made of the new vibration-absorbing material SORB TECH helps save around 60 % primary energy and enhances processing quality.

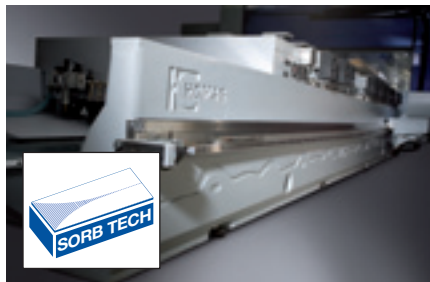

Outstanding surface quality

Outstanding surface quality due to vibration-damping machine beds and gantry.

Switch cabinet with powerTouch operator terminal

Central switch cabinet with height-adjustable Full-HD Multitouch Display, UVF for protection against data loss, Backup-Manager for data backup and network connection. Light at the switch cabinet for status display.



Energy efficiency built in

Effective suction with low connecting power through optimized collection and removal of chips. Reduced consumption of electricity through Stand-by operation of all performance components by pushing a button or automatically by time interval. Reduced air consumption through optimized pneumatic components.

As individual as your requirements

Deciding in favour of a HOMAG machine means investing in a highly efficient processing centre with the capability to fulfil wide-ranging different manufacturing requirements.

Each machine is a complete system guaranteeing maximum output and efficiency every time – no matter how individual your production requirements are.



Trimming of components with large Z height

Shaped workpieces

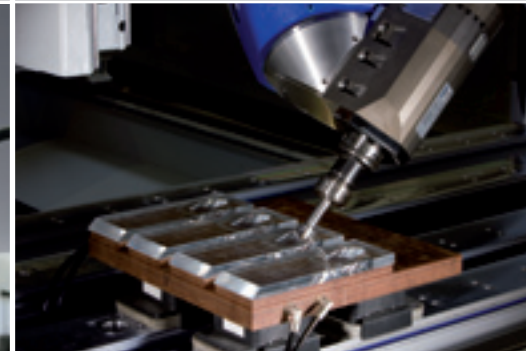

High-gloss trimming of acrylic parts



Trimming of machine components



Interpolating processing of freeform components

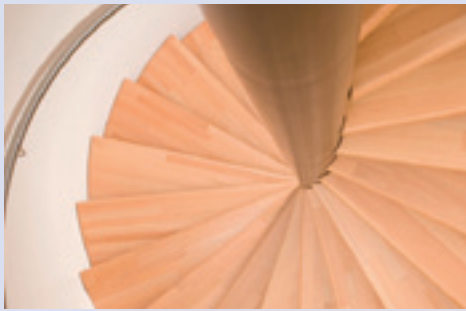

Doors

Staircases

Furniture



Precise, splinter-free miter cuts



Routing of a stair hand rail



Chamfer trimming on a table top

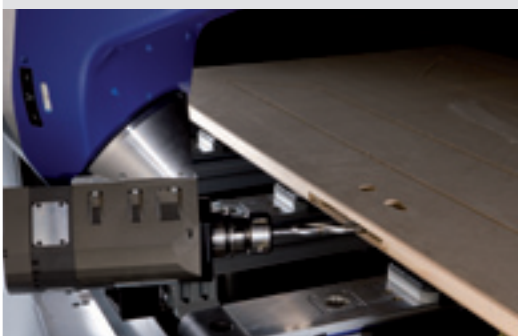

Lock case routing

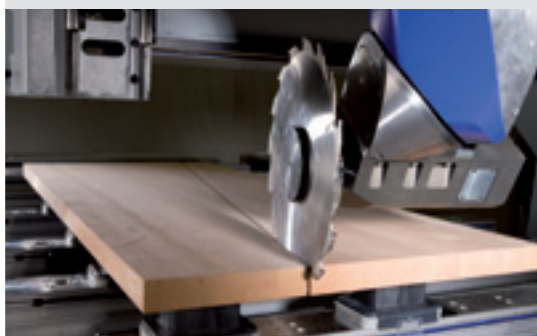

Dividing cuts up to 110 mm in height



Square corner routing for a glass rebate

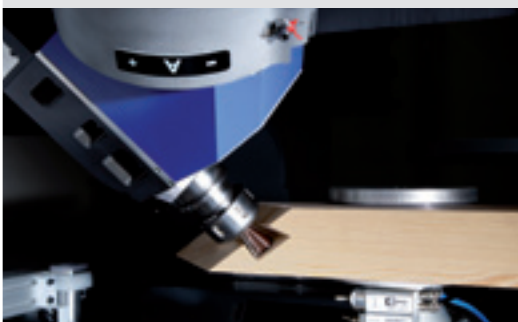

Routing of a dovetail joint for upright / transom constructions



Holes for piling at narrow angles

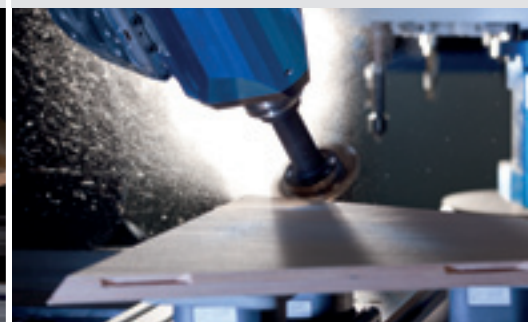

Trimming of inclined grooves for panel connection

Versatility - productively manufactured

As demand for individual solutions increases, our technology has all the right answers. Different design styles and structural solutions can be efficiently and economically implemented.

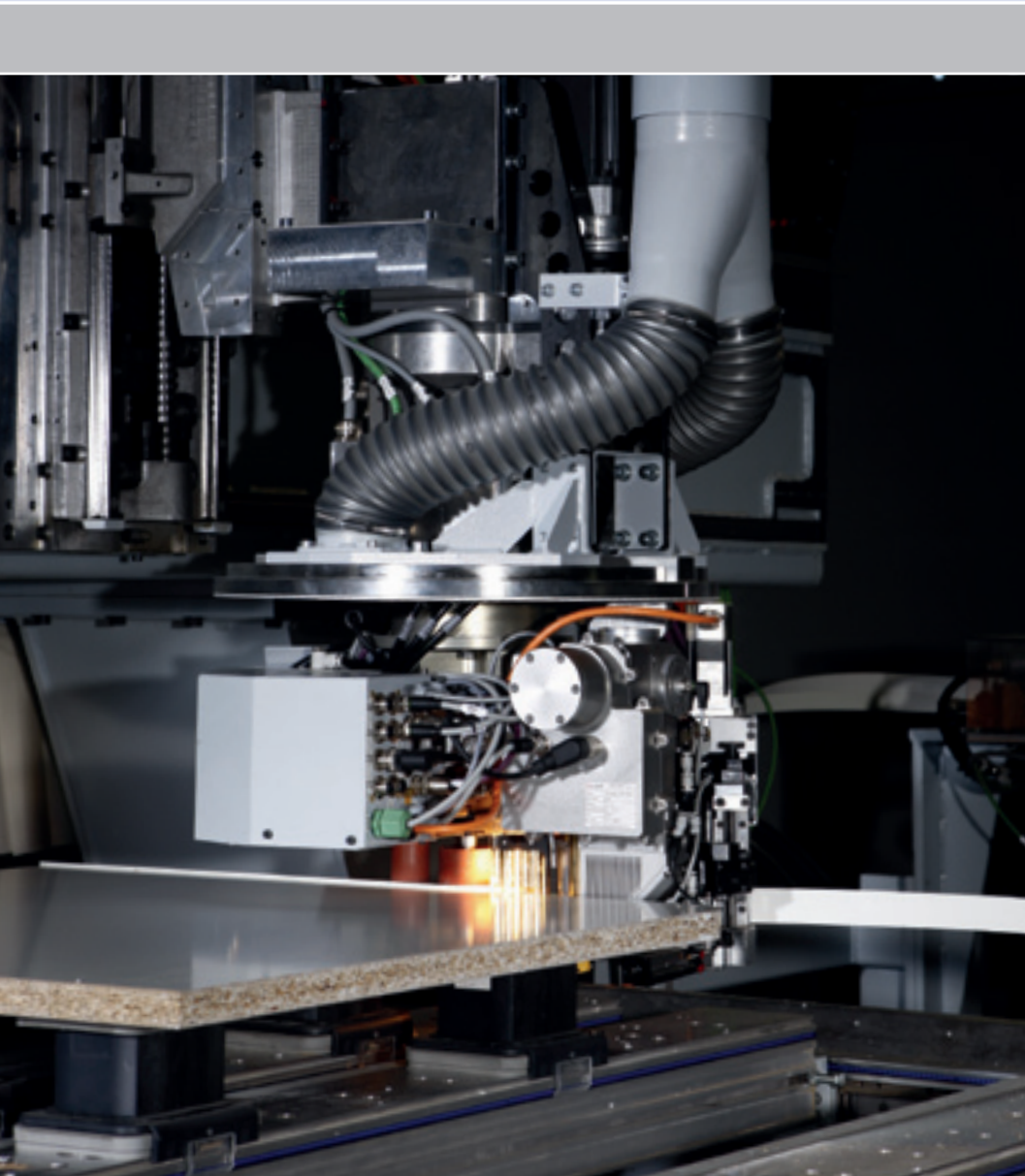

Edge banding



Gluing unit **easyEdge** for efficient banding onto shaped components



360° edge banding with the **powerEdge** edge banding unit.



Edge banding for components up to 100mm in height

laserTec shaped component edging with zero joint

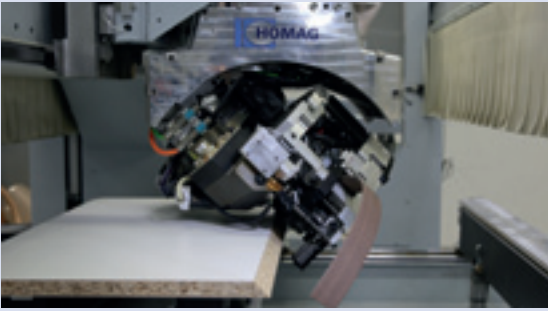

Edge finish processing

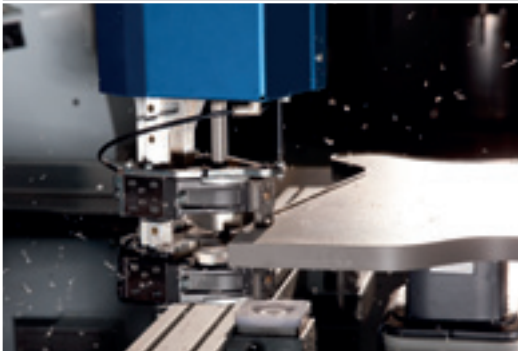

Perfect edge finish with traced combination flush trimming / scraping unit

Routing

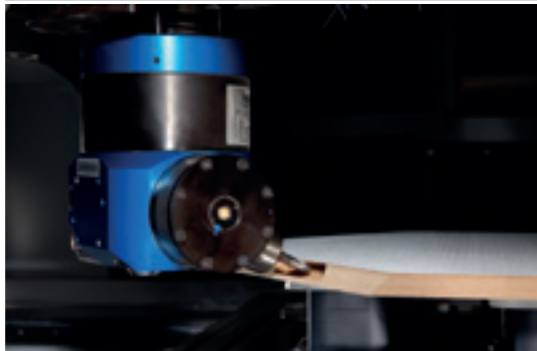

Free angle processing with the FLEX5+ unit

Drilling



High-speed drilling technology with grooving saw



Traced flush trimming of overhanging edges on postforming profiles

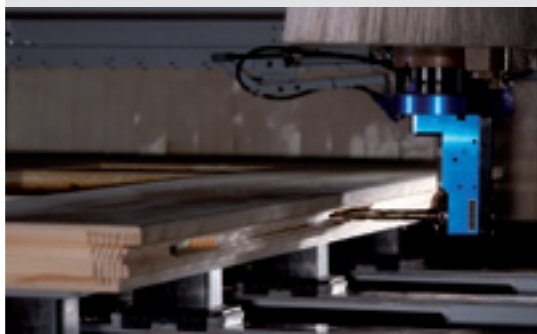

Lock case trimming on front doors



Horizontal boreholes for carcass connections

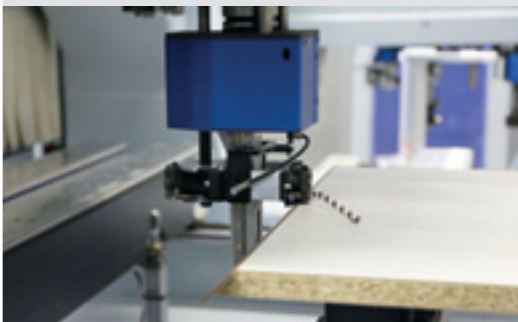

Scraping of mitered edges

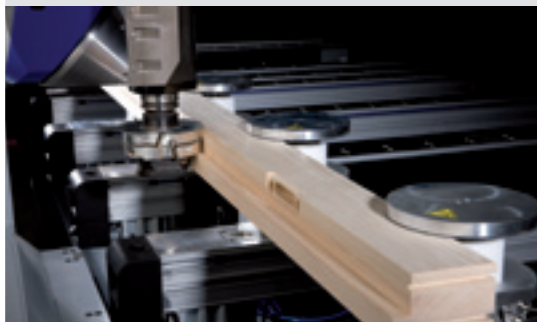

Profiling of frame components



Precise-fitting corner dowel connections

Scalable performance

Up to three processing units can be individually mounted for fast tool exchange, for instance two trimming spindles and one drilling head in conjunction with two tool changers.

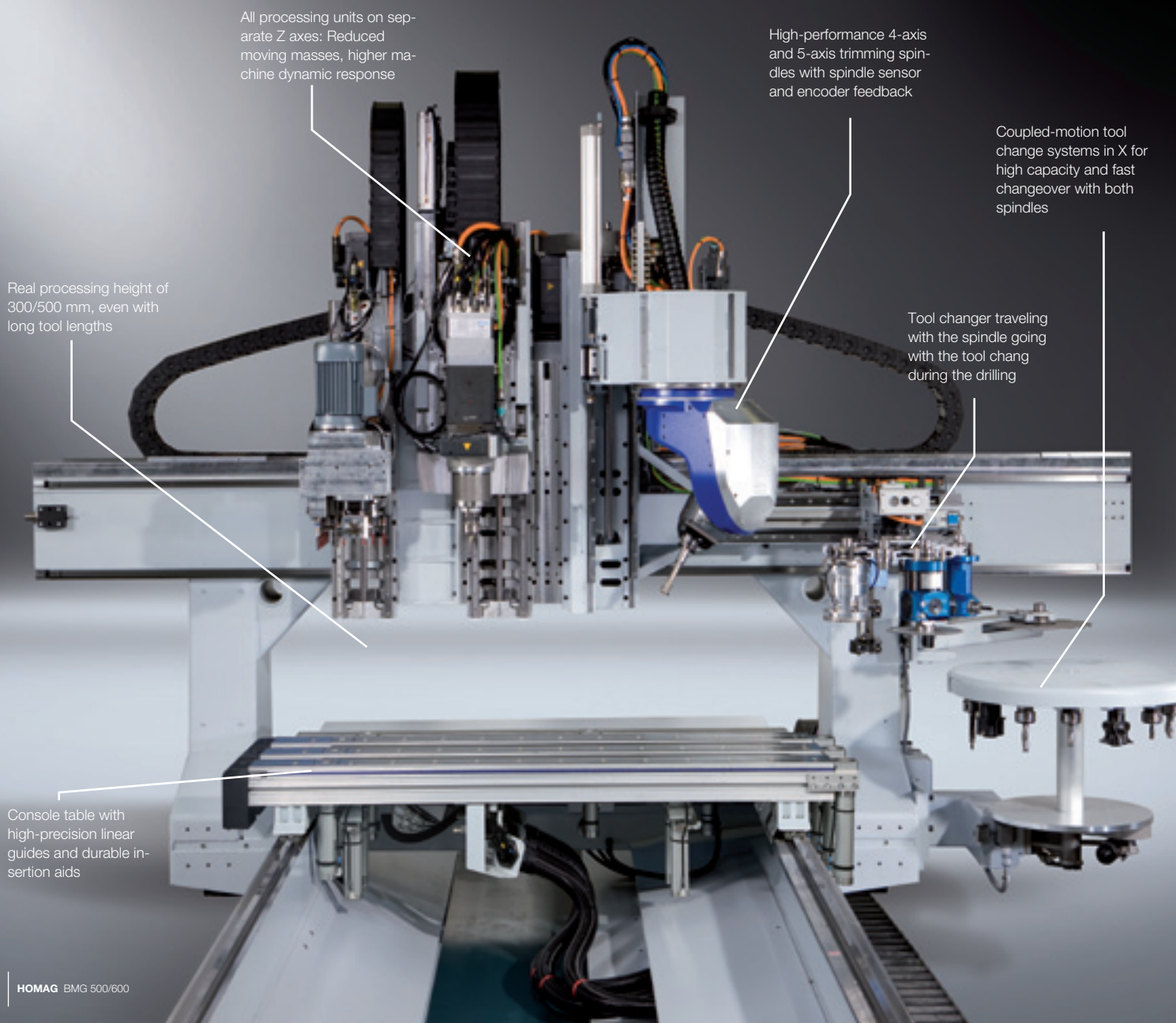

Highly rigid gantry construction using the finite element method optimized for a high standard of workpiece quality.

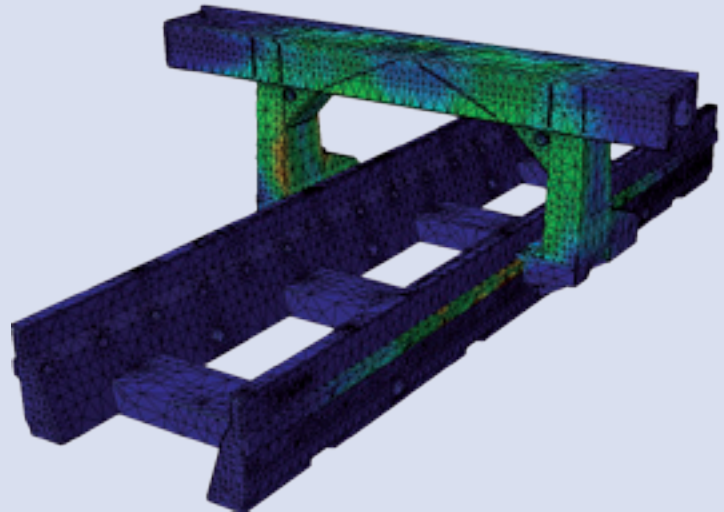

Tool changer

Tool storage facility with up to a total of 99 slots offers a basis for the flexible application of different tools and units even with large diameters up to 200 mm. Even saw blades with a diameter of 350 mm for extreme cutting depths and also shift cuts can be fitted (14-slot or 18-slot changer)

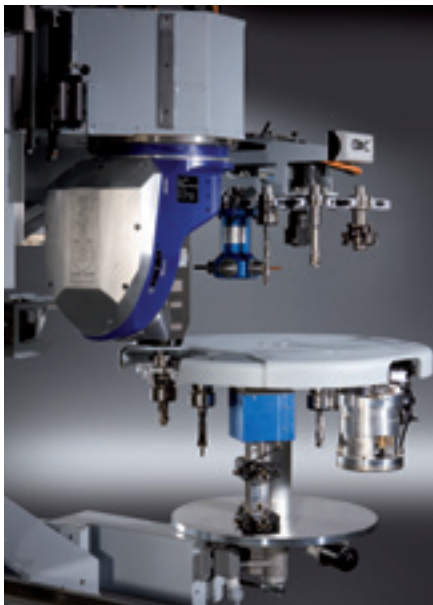

Synchronous processing

Synchronous processing of two workpieces clamped a fixed distance apart for maximum output using two trimming spindles with identically equipped tool changers.



High-speed tool change

The installation of two trimming spindles permits the reduction of chip-to-chip times and improved productivity. While one spindle is trimming, the second one is being fitted with the tool required for the next processing operation.



Workpiece fixture

Different table systems for flexible, safe fixture of different workpieces. Depending on the workpiece geometries and surface properties, fixture is optionally possible using vacuum, pneumatic and mechanical clamps.

Trimming spindles

Our working spindle technology sets whole new standards, enhancing both the performance and flexibility of our machines. For instance the enormous benefit of a controlled working spindle with electronic speed monitoring. Other highlights include the vibration sensors for preventing damage to the trimming spindles, the sensoFlex tracing system and 5-axis technology.

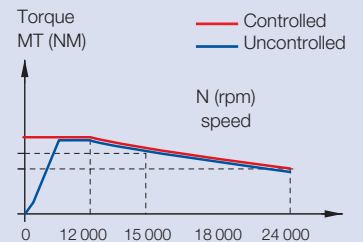

Vector speed control by means of encoder feedback at the working spindle ensures full torque right from speed 0.

DRIVE5C+ five-axis trimming spindle

Processing of shaped parts with high height through cartesian design and with high-performance processing up to 18,5 kW through double side bearing of the spindle.



DRIVE5+ five-axis trimming spindle

High-performance shaped component processing using a bilaterally supported spindle with Cartesian arrangement.

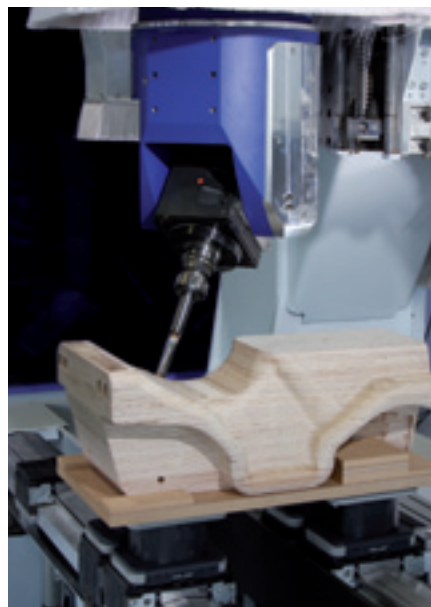

4-axis trimming spindle with unit interfaces

The unit interfaces open up practically unlimited production scope. Using patented technologies, the assignment spectrum can be extended at any time.

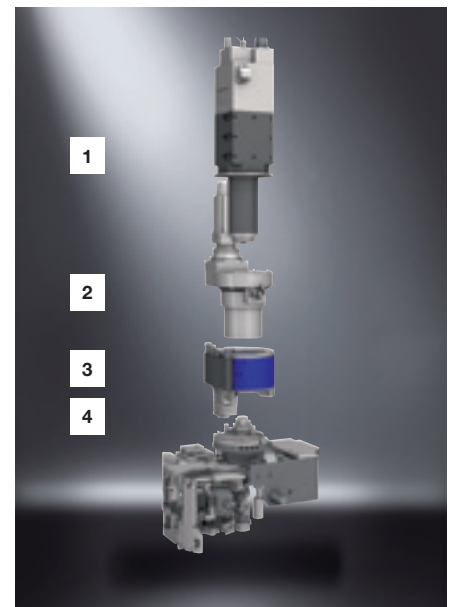

- 1 AC motor with fluid cooling
- 2 Interpolating C axis
- 3 E interface
- 4 FLEX5(+) interface

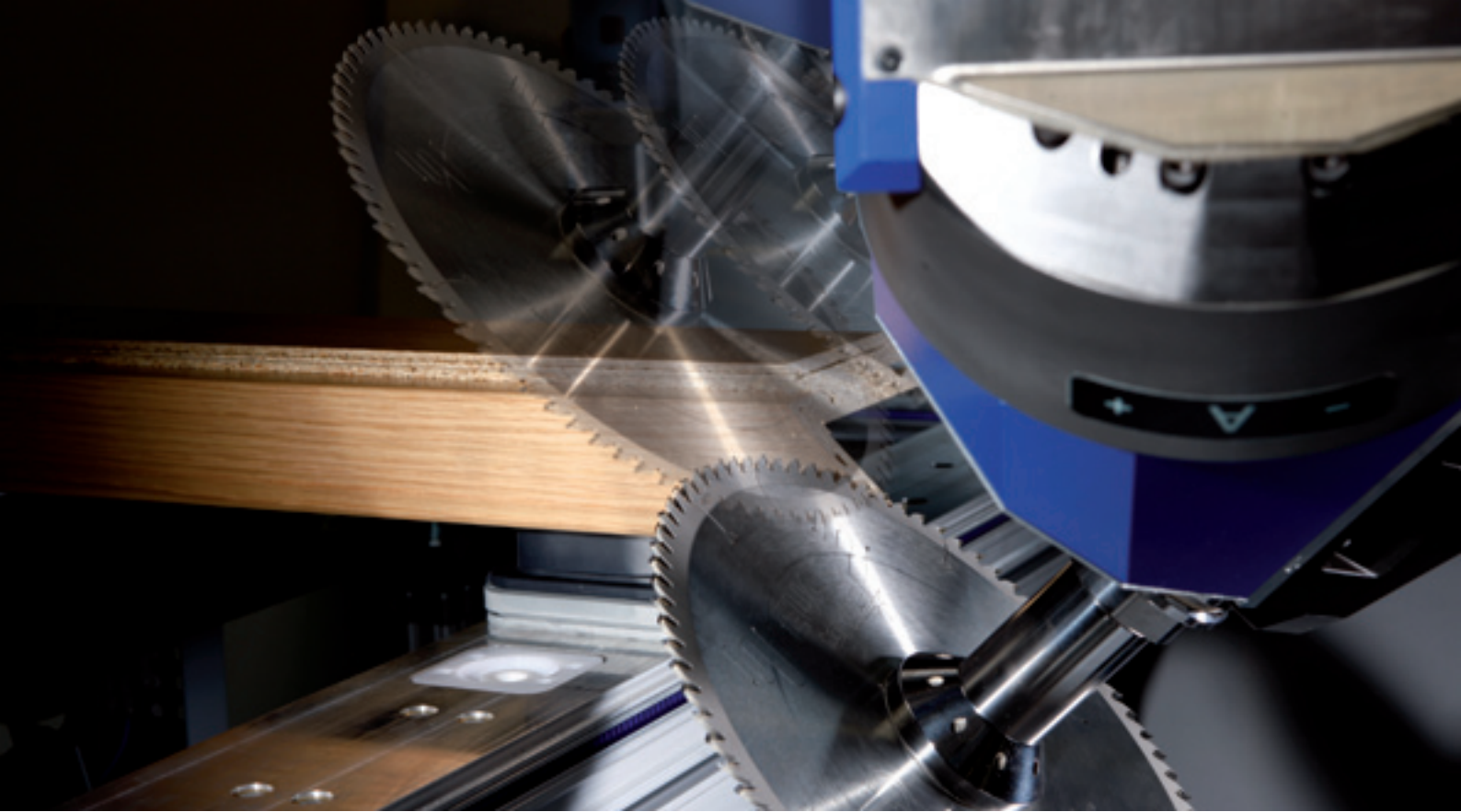

Fluid cooling and spindle sensor

Fluid-cooled trimming spindles with hybrid bearings provide a long service life. An additional vibration sensor detects tool imbalance and protects the spindle.



Minimum quantity lubrication

Machining of aluminium with minimum quantity lubrication through the unit or by means of an external spray pipe at the spindle for maximum care of tools.



Electronic interface

Patented technologies such as the electronic interface offer scope for upgrading the application spectrum of your processing centre: This also includes the use of edge banding units. The control signals and necessary energy, for example to melt the glue, are transmitted to the unit.

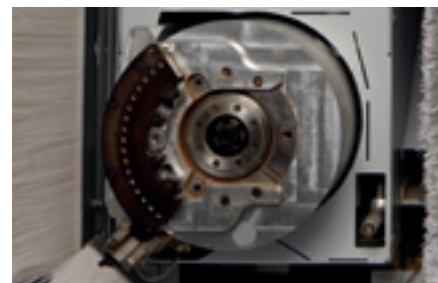

Pneumatic interface

The patented interface with threefold support at all C-axes and five-axis-heads enables the use of traced aggregates e.g. for exact rounding top and bottom independent of thickness tolerances.

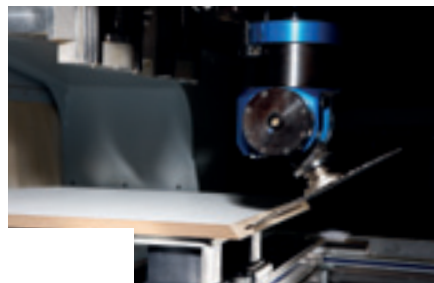

Sawing, trimming, drilling at any angle

FLEX5+ unit with automatic angle adjustment and automatic tool change. A unique unit for 4-axis spindles which covers over 90% of five-axis applications.

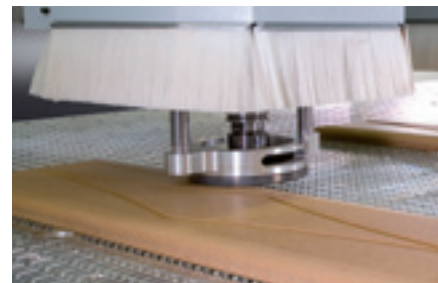

sensoFlex tracing system

- Perfect workpiece quality – the traced spindle compensates any unevenness and unwanted tolerances
- Complete flexibility through the use of tracing for different tools

Drilling systems to the highest standard

High-speed drilling technology, patented clamping of the spindle and quick-change system for tools. Precise drilling, fast cycle speeds, maintenance-free and durable design.

Drilling head V12/H4

HIGH-SPEED drilling head up to 7500 rpm with 12 vertical spindles, grooving saw and 4 horizontal spindles with 0/90° swivel facility. Fast drilling including grooving in the X/Y direction.

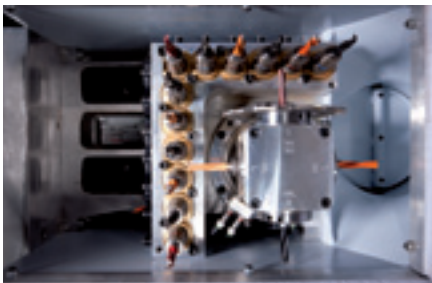

Drilling head V17/H4

HIGH-SPEED drilling head up to 7500 rpm with 17 vertical spindles, grooving saw and 4 horizontal spindles with 0/90° swivel facility. Fast drilling including grooving in the X/Y direction.



Multi Processing Unit (MPU)

The Multi Processing Unit has a stepless 360° swivel action. This allows the saw and also all 20 vertical and 10 horizontal spindles to be applied at any optional angle. An optional trimming spindle attachment saves tool changes and enhances productivity.

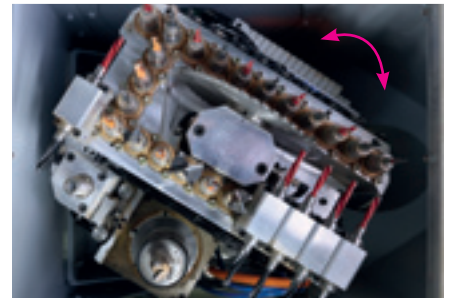
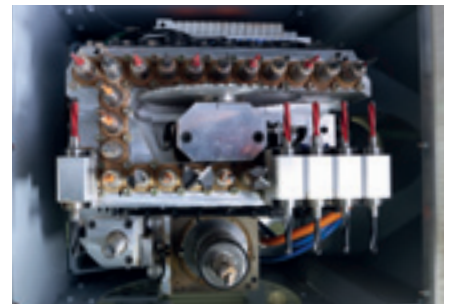

Drilling head V9/H4

HIGH-SPEED drilling head up to 7500 rpm with 9 vertical spindles and 4 horizontal spindles.

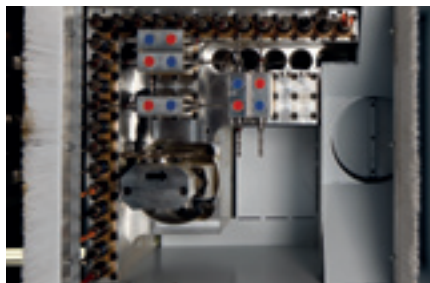

Drilling head V25/H10

HIGH-SPEED drilling head up to 7500 rpm with 25 vertical spindles, 6 horizontal spindles in the X direction and 4 in the Y direction including grooving in the X direction.



Quick-change system

Patented quick-change system for drill bit changeover without tools to reduce set-up times.

2+2-spindle drilling/trimming unit

The 4-sided spindle outlet makes available four different drilling and trimming tools without tool change. Continuous shaft for greater rigidity and processing without change of direction when using clockwise and counterclockwise rotating tools, e.g. when trimming out recesses for door hinges.

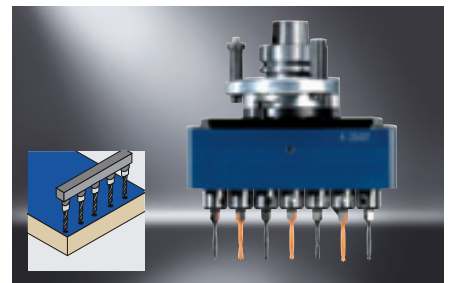
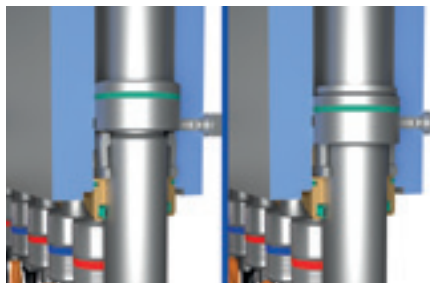

Drilling head with spindle locking mechanism

Automatic spindle locking mechanism: Patented system for precise drilling depth every time even with different materials. With speeds ranging from 1 500–7 500 rpm for high feed rates / short drilling cycles (appr. 1.5 sec.).

Drilling head, 7 spindles in a 25 mm spacing pattern

Specifically for the office furniture sector, 7 holes can be drilled simultaneously at any angle. As an addition to the drilling head with popular 32 mm spacing pattern, a high degree of flexibility is achieved with minimal production times. On request, other distances and drill bit numbers are possible, for example for cup hinge hardware drilling in a single work process.

Tool change systems

Simple flexibility. All neatly stored away for quick access. Tool changers provide the basis for the flexible deployment of tools and units, also for large saw blades or heavy processing tools.

Systems for all requirements

Tool changers with up to 99 (72 + 18 + 9) slots provide the basis for the flexible deployment of tools and units.

18/14-slot plate changer

For tools and units with a diameter of up to 200 mm. A saw blade with a diameter of up to 350 mm can be accommodated in the changer.



72-/ 30-slot chain changer

High capacity and extremely fast changeover times with prelocated double-action gripper.

72-/ 30-slot chain changer mounted underneath

In double-spindle machines, because the tool changer is positioned underneath, the same changer can be accessed by both trimming spindles.

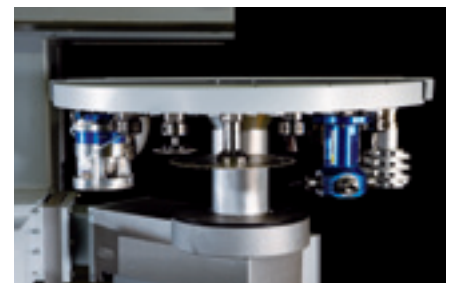

10-slot plate changer

Tool change during drilling or processing with the 2. spindle with changer traveling with the spindle. For tools and aggregates with a diameter up to 180 mm.

Units

Excellent processing quality and top marks in terms of speed. HOMAG Group processing units make available a range of innovative technologies. They can be combined and coordinated precisely to address your own specific application situation. Even special, non-standard assignments are reliably and efficiently processed.



More information is provided in our processing unit and clamping element catalogue.

Linear changer

Additional tool change magazine, with 8/9 slots and integrated tool transfer station, laterally mounted. The magazine also accommodates the pickup station for the optional easyEdge unit.

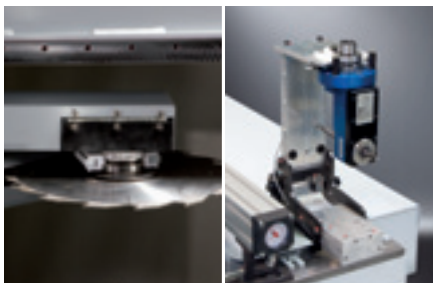

Pick-up station & tool transfer station

An additional pick-up station for saw blades with a diameter of 350 mm saves space in the tool changer.

A tool transfer station increases operating convenience and helps prevent errors in the equipment of tool changer slots for improved safety.

Underside trimming unit

For trimming and drilling the underside of workpieces, e.g. recesses for kitchen worktop connectors or hardware holes in the edge area without the need to flip the workpiece. The maximum distance to the workpiece edge is 110 mm and the maximum tool projection is 30 mm.

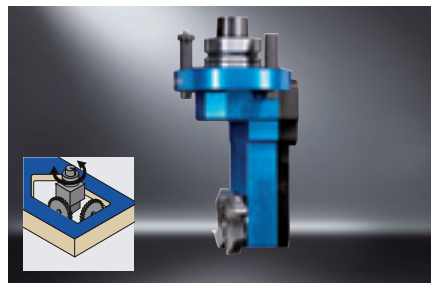
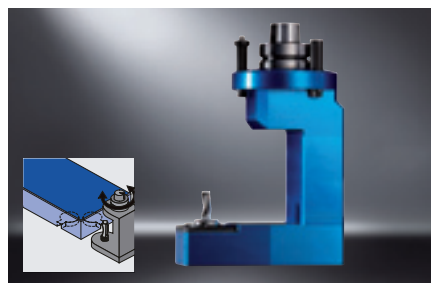

Corner notching unit

For the production of right-angled, splinter-free, sharp-edged recesses, for example for efficient processing of door glazing cutouts, sink cutouts in kitchen worktops.

Vertically traced trimming unit

By means of a tracing ring with dia. 70 mm / dia. 130 mm, or tracing pad, it is possible to perform operations such as pocket trimming in precise relation to the workpiece surface. When connecting kitchen worktops, tracing guarantees an offset-free transition by precise trimming of grooves for the tongue and groove joint.

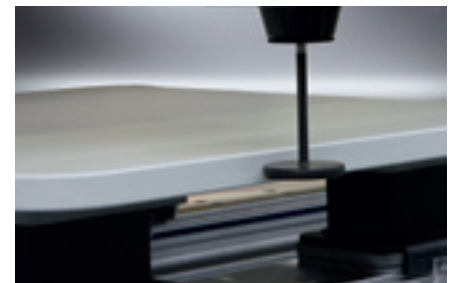
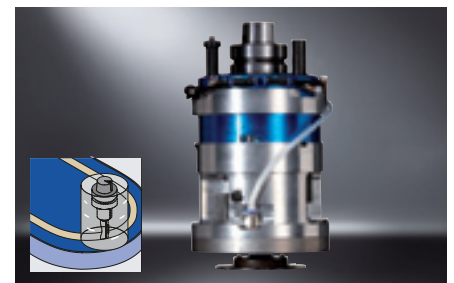

Measurement probe

Tracing system to determine the actual X, Y and Z axis measurement of relevance for processing with automatic correction offset in the processing program.

Edge banding with the BMG500: perfect edge quality with easy usage

HOMAG processing centers with edge banding units are real all-rounders. With them several working steps from panel sizing, profiling and drilling to edge banding can be executed on one machine.

Comfortable and rapid insertion and changing of edging materials by installation of the edge magazine at the front side of the machine

Simple top-up of hot-melt glue, simple monitoring and servicing of the gluing section.

External preparation of edges due to exchangeable coil plates.



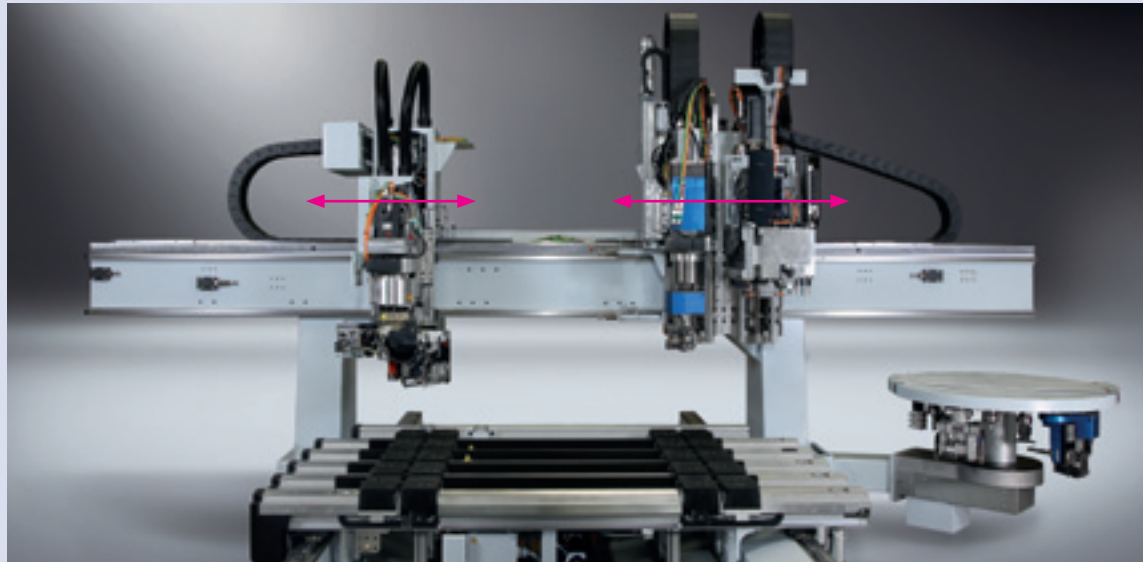

High output with low space requirements: Independent Y axis on one side of the portal for gluing unit and trimming spindle/drilling head.

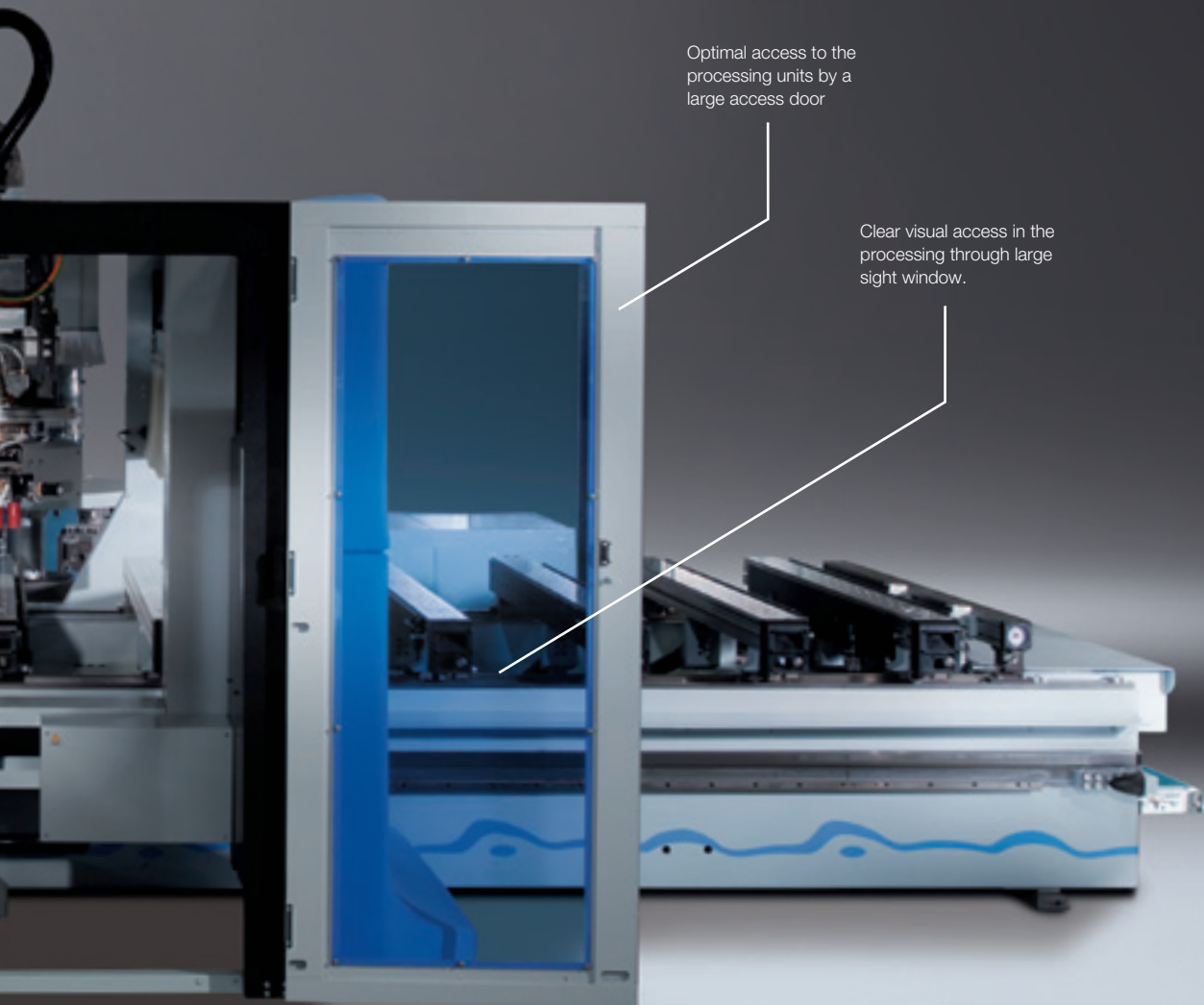

Innovative edge banding technology for all

HOMAG Group processing centres are ideally prepared for the use of ultra-modern edge banding technologies. The edge banding units are offered in a variety of performance categories and can be ideally coordinated to address your individual production requirements. Their patented electronic interface makes them easy to operate and ensures optimum control precision.



Rebate edges, softforming, internal corners, inclined edges: For more information on edge gluing and finish processing, see our Unit and Clamping Element Catalog

powerEdge edge banding unit

The **powerEdge** edge banding unit is the culmination of experience gathered from over 2,000 processing centres for edge banding and forms the basis for a complete family of edge banding units to cover a wide variety of applications.

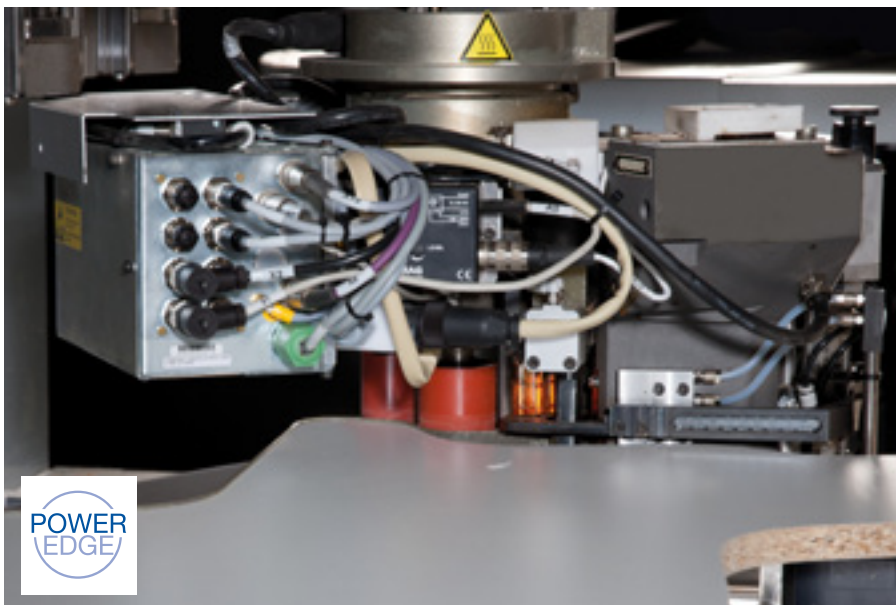

Using the electronic interface, additional energy is transmitted for heating, as well as control signals for high-precision, automatic butt joint edge banding. The interface offers the unique flexibility needed to use even different edge banding units on a single processing centre, or to use the processing centre for other tasks during maintenance of the edge banding unit.

laserTec edge banding unit

Edge banding to a previously unattainable standard of quality: HOMAG **laserTec** – the quantum leap for furniture production.



It entails melting the surface to be glued using a laser beam and then pressing it directly onto the workpiece. The result: Exceptionally high quality edges, no visible transition between panel and edge (zero joint), higher holding force, better heat and moisture resistance.

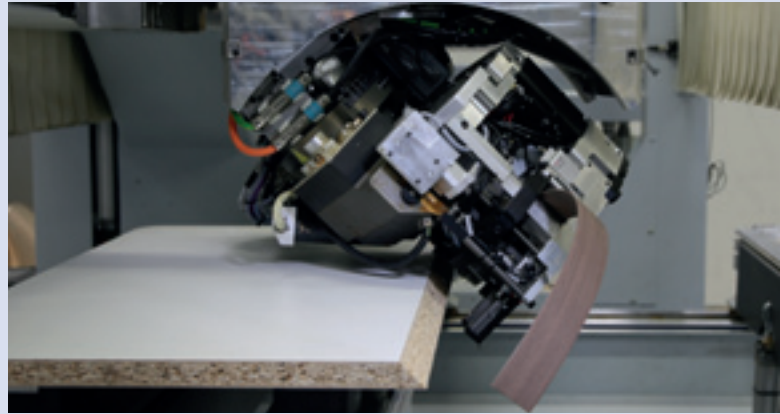

Inclined edge banding at any optional angle of inclination. The automatic unit adjustment facility allows both shaped edges and inclined edges to be applied to the same workpiece.

easyEdge edge banding unit

The world's smallest edge banding machine – affordable, simple, efficient. The universal solution for edging small workpiece quantities with veneer edges, ABS edges, PP edges, melamine edges and thin PVC edges. In conjunction with a manual snipping unit, it is even possible to perform 360° butt joint edge banding in craftsmanship quality.



The **easyEdge** unit is directly picked up from the station in the linear tool changer. Feeding edge and ready to go! The aggregate can be used with all 4- and 5- axis-spindles.

Combined flush trimming - scraper blade unit

Combination unit for flush trimming the edge overhang and for scraper blade finishing. This removes cutter marks and other unevenness on the edge profile. Three-sided unit tracing compensates for workpiece and edge tolerances and guarantees a high standard of processing quality.

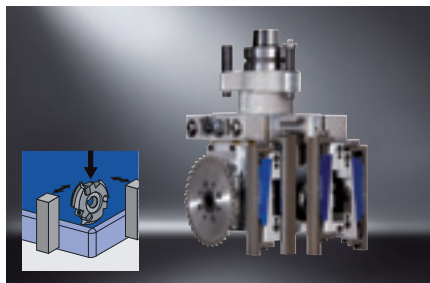
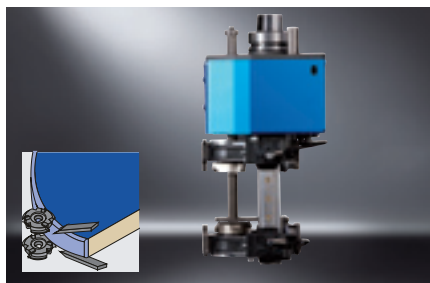

Combined snipping and corner rounding unit

Already edged rectangular workpieces are often finish processed on a processing centre, for instance to produce bevels or rounded contours. For finish processing, this patented unit provides, alongside traced cross-cutting of overhanging edges, also precise corner rounding of edges up to a thickness of 3 mm at a 90° workpiece corner.

Flush trimming unit with separating agent

Separating agent application during flush trimming reduces the amount of glue residues on the workpiece and often eliminates the need for scraping the glue joint with a glue joint scraper blade unit (depending on the glue and edging type and on the quality expectations).

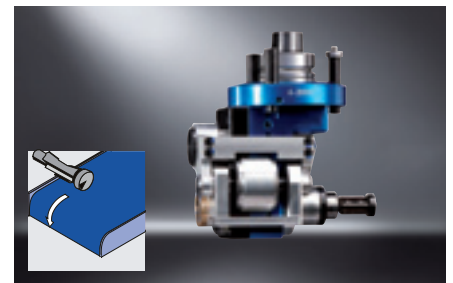
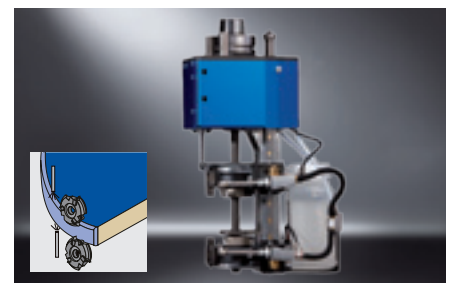

Horizontally traced trimming unit

By means of a tracing roller, horizontal trimming operations are performed precisely relative to the workpiece surface, e.g. during flush trimming of overhanging edges on the postforming profiles of a kitchen worktop. The diameter of the tracing roller and trimming tool are coordinated, generally to 20 mm.

Fast, neat and convenient – the console table

The classic with the dual-circuit vacuum system: Easy, practical and fast: Through the patented system of the magnetic valves the vacuum cup and other clamping devices can be put on the console in any number and on any position. Not used suction points do not need to be covered. Unified height for all clamping devices allow to combine them among themselves. The K-table is the ideal solution, if flexibility, secure clamping of different parts and fast exchange are required. .



Linear guide and insertion aid

Simple handling by consoles with high-precision linear guides and durable insertion aids with two pneumatic cylinders. Vacuum and compressed air connections are integrated in the consoles for pneumatic clamps and clamping templates.

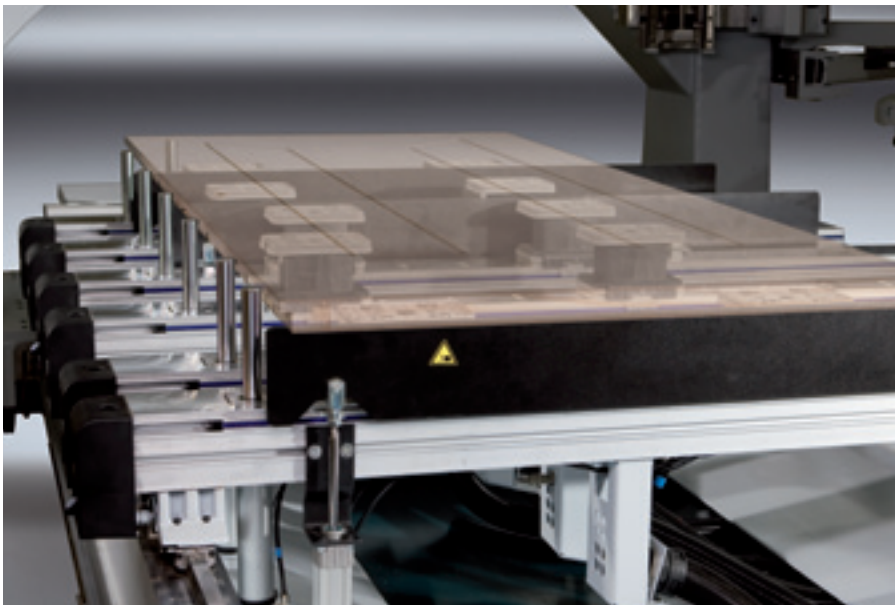

Bolts with end position scanning and for laminate overhang

Stop bolts with end position monitoring to protect tools, units and machine operating staff. Exchangeable stops specifically for workpieces with laminate overhang.

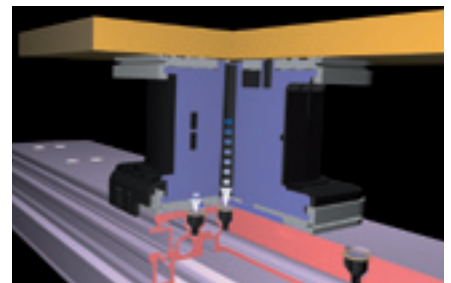

Dual circuit vacuum system

Exclusive vacuum clamping technology with patented double sealing lip for the stepless displacement of clamps along the console. The first clamping circuit fixes the clamps in the console and prevents unwanted displacement. The second then holds the material firmly in position.



Suction cups are displayed using a laser beam (cross hairs). The workpiece contour can be “travelled” as a positioning aid for freeform parts.



LED system – both the fastest and safest positioning system for consoles and clamping elements (patented).



Laser projection of the clamps and the workpiece contour for optimum utilization and simple positioning of raw parts which cannot be aligned at the stops.

powerClamp

Manual clamping fixture **powerClamp** for straight and curved parts. Ideal for all arched, narrow and frame parts.



Clamping device

Uprights and staves can be securely clamped in no time using this clamping device.



3-step clamp

Highly rigid 3-step clamps with extreme clamping height for precise complete processing of window and front door components without subsequent outside moulding and profiling.

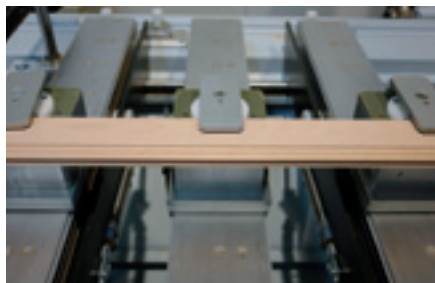

Multiclamper for dual circuit vacuum system

Vacuum actuated clamping element for clamping strips and staves

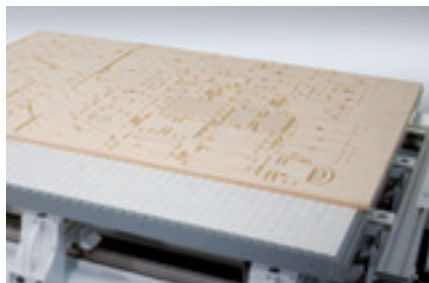

Matrix adapter plate

Highly flexible clamping systems offer secure fixture even when working with filigree workpieces. The matrix adapter panel even permits shaped components to be “cut to size” with optimized cutting waste on a console table machine using the nesting process.

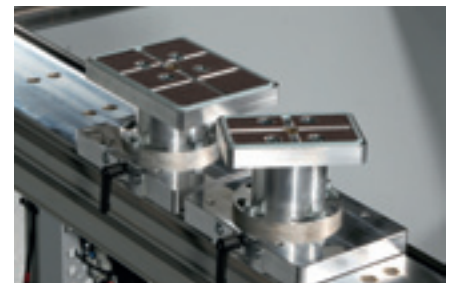

Vacuum clamps made of aluminum

Vacuum clamp in aluminium with additional mechanical clamping operation at the console for engaging solid wood parts. The suction plate can be rotated and also exchanged, and is lined with emery cloth.

Automatically in the right position: The A table

The A table is the key to greater convenience and automation. The program-controlled positioning of consoles and clamping elements allows batch size 1 operation without manual intervention and allows workpieces to be moved apart after the execution of a dividing cut.



movePart

The clamps move apart automatically in the program sequence after separation for complete processing.



powerClamp

powerClamp clamping fixture for straight and curved parts. Ideal for all arched, narrow and frame parts. Also with automatic reclamping for 5-sided processing.



Clamping device

Uprights and staves can be securely clamped in no time using this clamping device.

Versatile application: the matrix table

The grooved aluminium matrix table permits the positive locking of clamping elements and consequently reliable workpiece fixture even where high hogging forces are involved. The transmission of vacuum through the table construction optimizes distribution of the vacuum, reduces leaks and transmission losses and does away with the need for complex installations. Using different clamps with variable clamping heights, the matrix table is also suitable for the use of units.



Maxi-Flex system

Freely equippable system base plate for vacuum clamp.

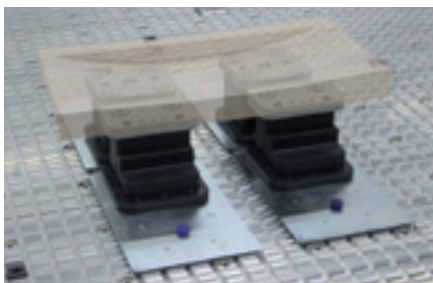

Multiclamp

Vacuum actuated clamping element for clamping strips and staves.

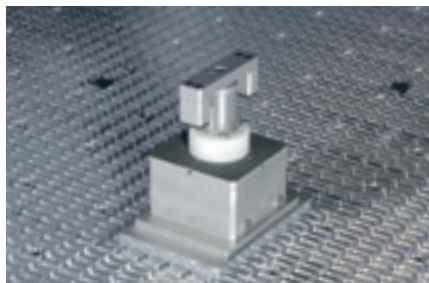

Fixture using non-standard clamps

The aluminium grid table with dovetail guides guarantees precise, positive fitting clamping element fixture.

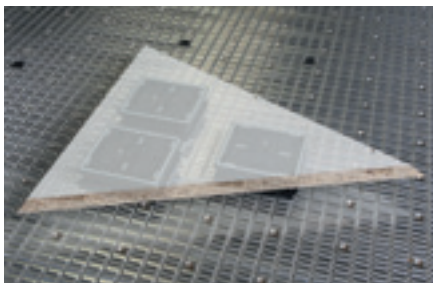

Vacuum clamp

Vacuum clamping elements for insertion in the grooves of the grid table.

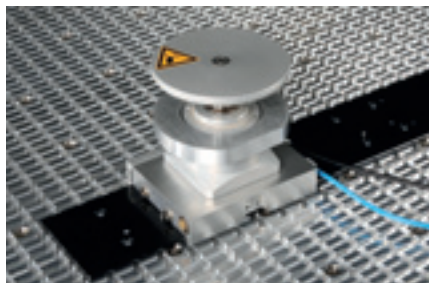

Rail for powerClamp clamping elements

Rail for fixture of the **powerClamp** clamping elements from the K table range for pneumatic clamping of wooden staves, arch parts or stacks of panels. Mechanical fixture of the rail in the system groove is possible in both directions on the table. Alignment of the clamping elements with stop pins.

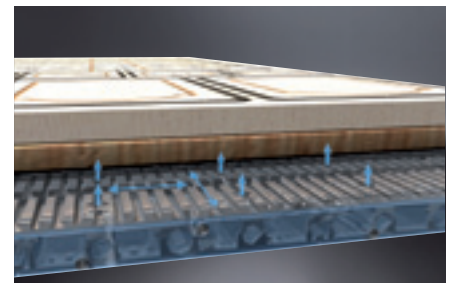

Vacuum grid table with air cushion function

The vacuum transmission is integrated in the design of the aluminium grid table. Division into zones and efficient vacuum pumps ensure reliable clamping, even for nesting processes with underlay panels. The air cushion function makes light work of handling large-format panel-shaped workpieces.

Tailor-made clamping solution

The possibilities of our processing centers do not end in the catalogue. The tables and basic components are the basis for your customized solution: A variety of standard clamping elements, specific adapted clamping devices for your requirements or your own devices are also possible as workpieces in the XXXL-size, which also can have 10 m length or 3 m depth.

Round windows processing

Automated complete processing of round windows without manual intervention in the process through special machining sequence.

Narrow sash bars and thick profiles

No limits for window manufacturing: The HOMAG 3-step clamping system also fixes thick profiles up to 120mm (option 150mm) and narrow sash bars secure and precise.

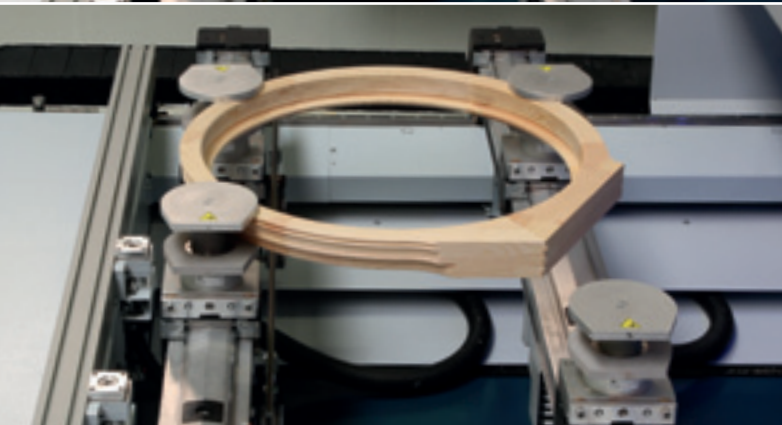
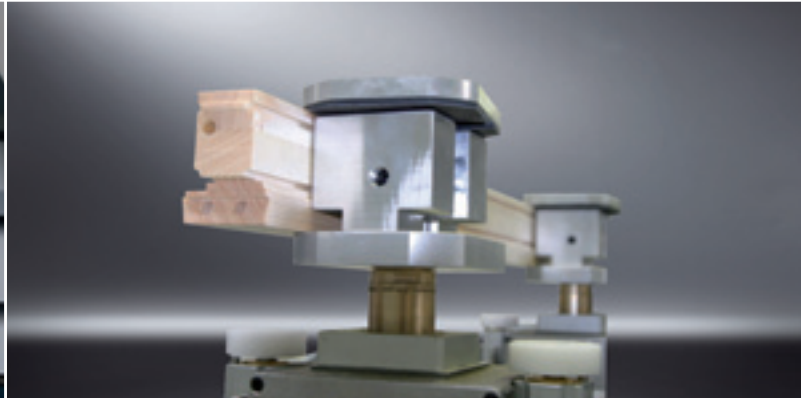
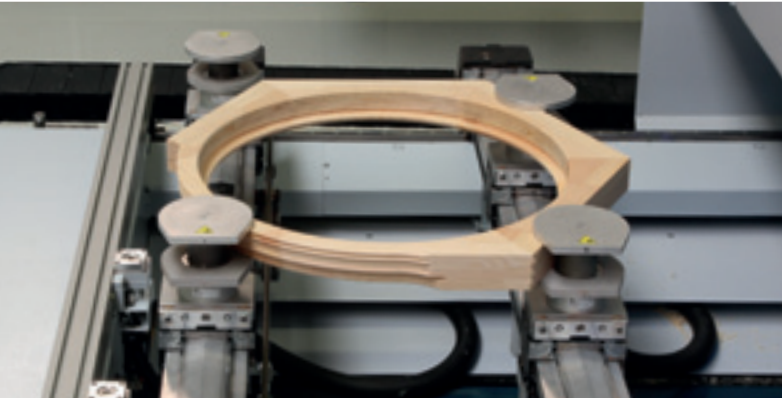

Sash outside profiling

Also suitable for the classical production: With swing clamps sashes can easily be inserted, aligned and hold.

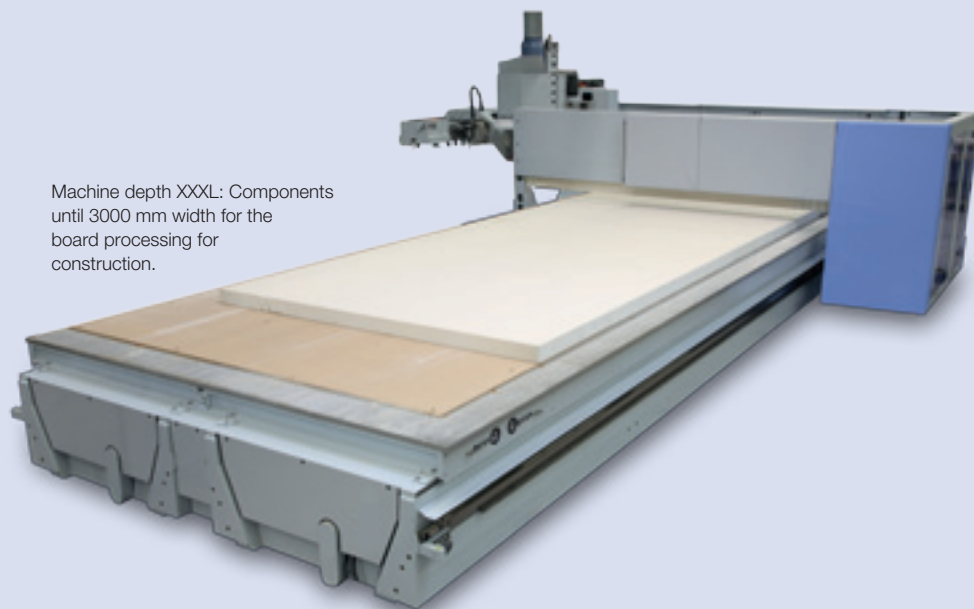

Machine depth XXXL: Components until 3000 mm width for the board processing for construction.

Block clamp

Adapted block clamping fixture for round timber elements.

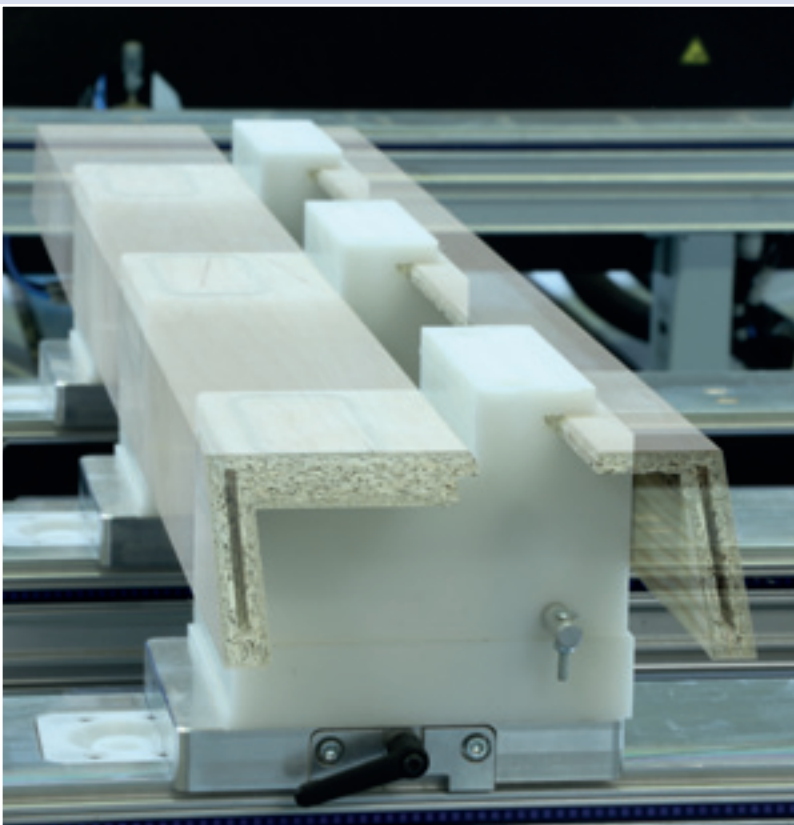

Clamping fixture for facings

Vacuum clamping fixture for a pair comprising rebate and ornamental facings according to customer design. Mounted on a base plate module.



Clamping fixture for round pipes

Clamping fixture for 5-axis processing of round plastic pipes.



Better the automatic way: Made to measure manufacturing solutions

Using intelligent solutions, we turn CNC processing centres into complete production cells with automatic material handling and specific supplementary functions. This is how to make optimum use of your machine and achieve maximum output. All these benefits are made possible using innovative system technology based on long years of experience in the construction of complex plants of all different sizes all over the world.

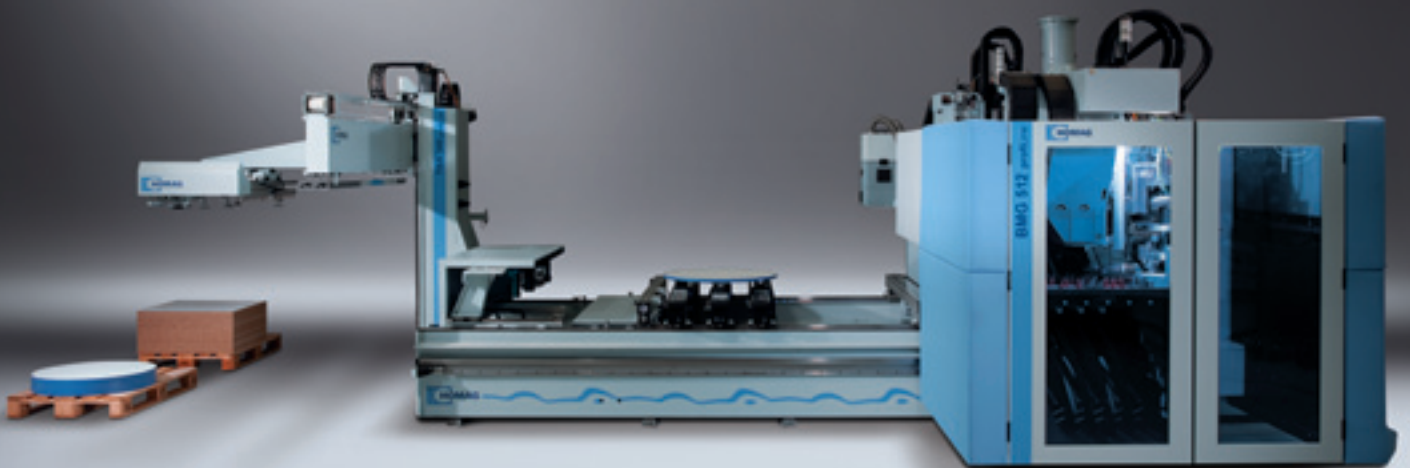

TBA feeder attachment

Simple, space-saving entry into the world of automation with the TBA feeder attachment mounted laterally at the machine. Reliable handling, precise positioning and integrated workpiece cleaning. Extreme operating and programming simplicity through direct use of the woodWOP processing program.



Gripper technology with a system

Integrated sensor functionality prevents errors as a result of adhering parts, while monitoring that workpieces are correctly picked up.

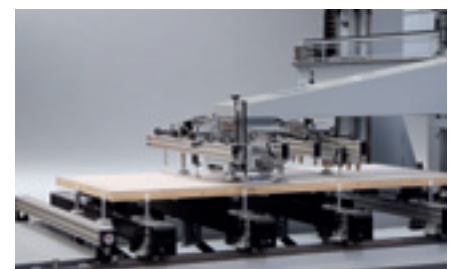

Alignment against stops

Articulated suction grippers permit precise positioning of workpieces against the stops on the machine table.

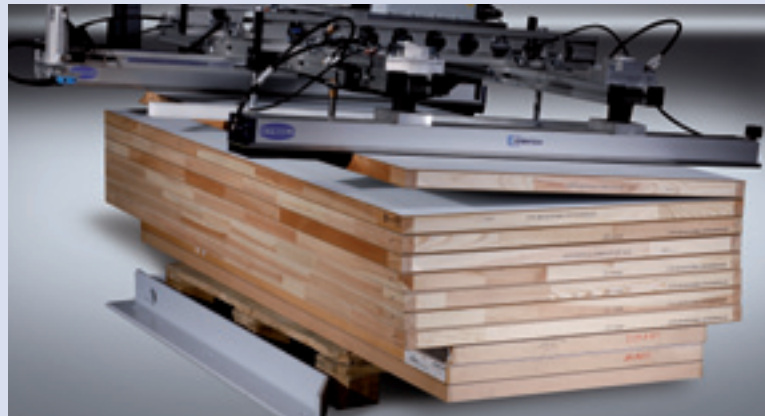

Handling automation: safe, material friendly and economical.

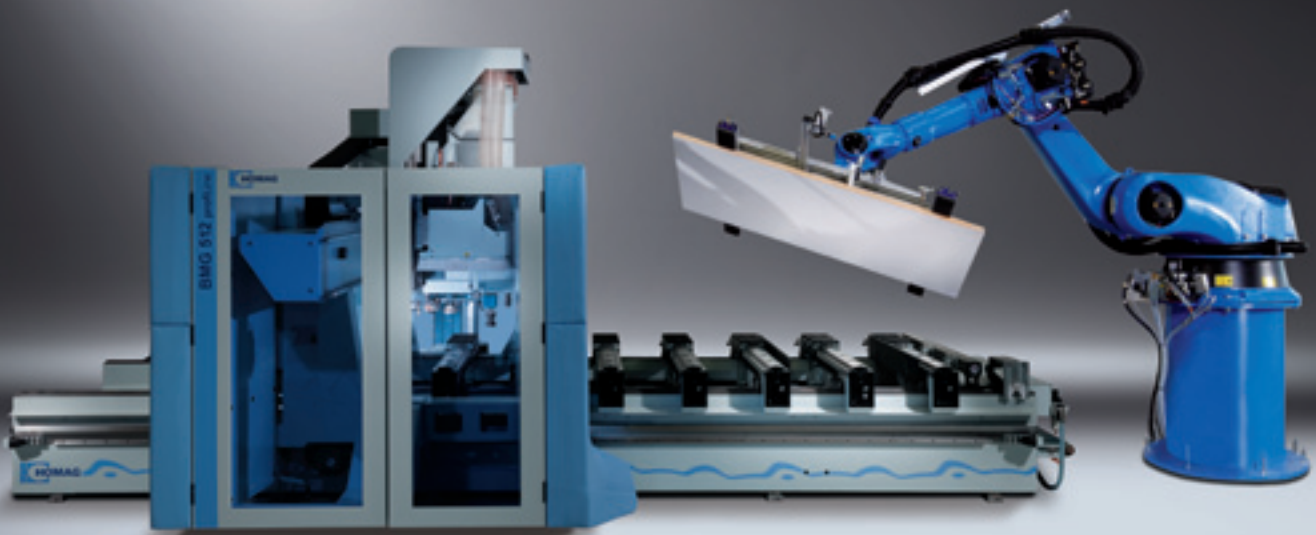

Robot handling systems

Unlimited workpiece handling with different layer patterns, storage positions, alignment and flipping. Supplementary functions such as labeling, position measurement or cleaning can be simply integrated.



Alignment, validation and turning over

Free robot movement in up to 6 axes permits additional functions to be simply integrated into the process (e. g. turn over function for processing on both sides).



Cell control and visualization

For reliable, efficient cell operation, in particular with batch size 1 production, HOMAG offers a simple, intuitively operated user interface for visualization and control of the entire cell.

HOMAG software:

The basis for simple, efficient operation

Our processing centres are one thing – the software needed for their convenient, simple operation day in, day out is another. This is why HOMAG software guarantees extreme flexibility and operating reliability. A matter of course at HOMAG: interfaces to external programming and design systems, help programs for interleaving and modules to help you monitor your machine and track its performance.

powerTouch is the latest operating philosophy of the HOMAG Group. It combines design and function to create a completely new control generation. The new system is characterized by the full HD multitouch monitor, ergonomic touch operation, simple navigation and the standardized user interface.

For more information, refer to our brochure Software for processing centres.



woodWOP - streamlined operations through fast programming

- Fast, intuitive operation based on simple, direct navigation
- Free use of variables for flexible variant programming
- Fast creation of own subroutines
- Increased programming reliability through 3D images of workpieces, processing and clamping equipment
- High degree of operating convenience due to freely configurable windows, multiscreen capability, language-neutral input screens, help graphics and much more.
- Biggest forum for CNC programming in the Internet: www.woodWOP-Forum.de

woodWOP CAM plug-in

- CAD/CAM functions integrated directly in woodWOP
- Fast constructing of 3 surfaces in CAD-Plugin or through import of 3D models
- Automatic generation of tool paths for roughing, smoothing and sizing of 3D objects
- Safe working as the tool paths and travelling ways are graphically indicated and simulated in woodWOP

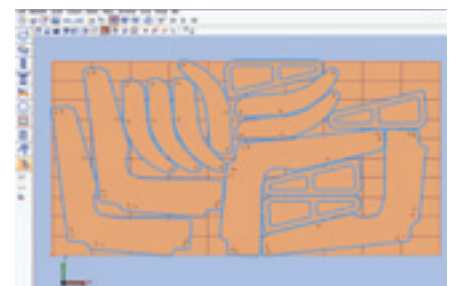
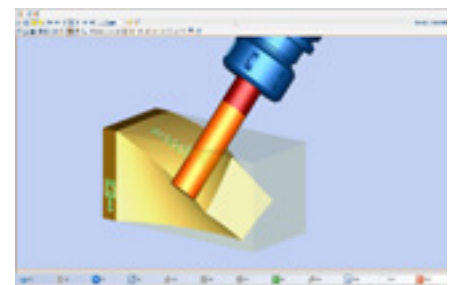
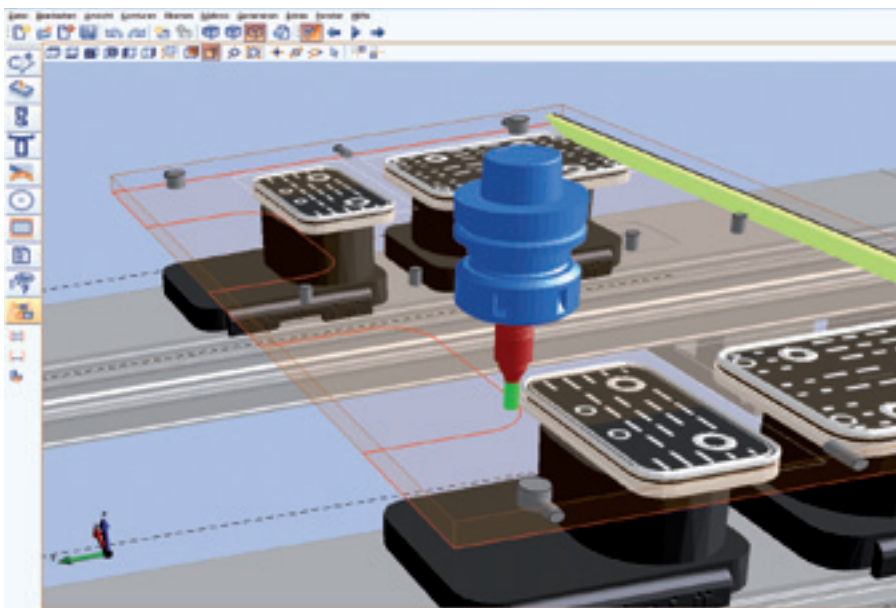

CAD plug-in

- CAD functions integrated directly in woodWOP
- CAD drawings can be generated directly at the machine and at the production engineering workstation
- Import of CAD drawings in DXF format
- Intuitive operation and fast familiarization with a standardized user interface

Cut Rite optimization Nesting

- Nesting software for automatic interleaving of workpieces on a raw panel
- Material cost savings due to optimum utilization of the raw panel
- Individually adjustable optimization parameters help reduce overall processing time and take care of process reliability



woodWOP Wizard – your automatic route to the perfect edge

- Automatic generation of the complete processing sequence for edging
- Generation of all processing steps such as rough trimming, jointing trimming, edging, snipping, flush trimming and scraping
- Takes into consideration workpiece geometry, edge transitions and edge type
- Time savings of over 90 % compared to conventional programming

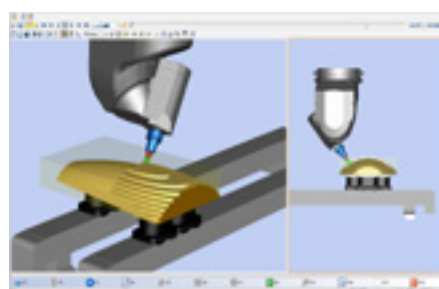
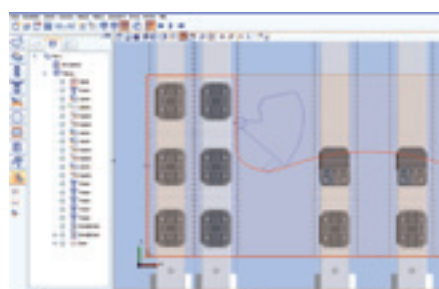

woodMotion - processing program simulation

- Graphic simulation of the CNC program at the office PC
- Reduction of machine running-in time due to optimum program preparation
- Simulation of 5-axis processing including material removal
- Display of real processing time
- Collision monitoring between the tool and clamping elements

woodScout - help in your own language

- Optional high-performance diagnostic system
- Graphic display of the fault location at the machine
- Clearly understandable plain text error messages in different languages
- Learning capability through the assignment of root causes and remedial actions (expert knowledge)



Machine data acquisition MDA – for a productive environment

- Registration of piece numbers and ACTUAL operating times at the machine
- Integrated maintenance instructions for the optimum time and quality-based planning and execution of maintenance work
- Optional professional version permits detailed breakdown and logging of registered data

collisionControl – permanent safety for your machine

- Monitors possible collisions between machine components and clamps during processing
- Automatic machine stop in the event of an impending crash situation
- Display of the crash situation in the form of a snapshot with collision bodies shown up in colour
- Machine shown as a moving 3D model in live mode

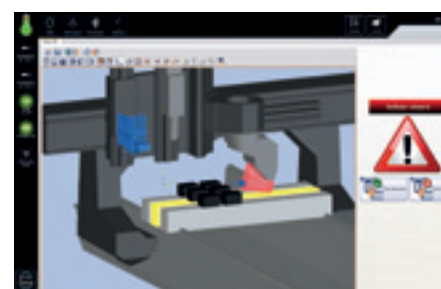

Graphical tool database

- Dimensioned graphics for simple set-up and management of tools and units
- 3D view of tools

Services



lifeline | service

The sale of our machines comes with all-in optimum service backup and individual advice. We place the entire wealth of our extensive expertise at your service, both at the procurement stage and during running operation. The HOMAG Group lifeline | service ensures optimum availability and economical production – over the entire life cycle of your machine.





The ServiceBoard mobile application reduces costs through fast assistance in case of faults with live video diagnostics, online service report, online spare part shop eParts.



Low energy costs

- Intelligent stand-by operation reduces energy costs during break times or in case of partial capacity utilization by up to 10 %, saving up to 8 000 kWh of power per year
- A flap control system switches the volumetric flow of the extraction system to the processing units actually in use. This cuts up to 20 % of the costs for extraction, corresponding to a saving of up to 12 000 kWh per year

Value stability and long machine service life

- Facility for continuous upgrading of processing centre functionality using standardized interfaces ensures compliance with future production requirements
- The HOMAG conversion department offers solutions to address major conversion requirements, ensuring a high degree of investment security over years

Optimum financing

- HOMAG Finance offers optimized financing concepts based on individual business administration requirements
- The outstanding value stability of HOMAG processing centres offers benefits in terms of leasing and subsequent replacement investment

High degree of availability through preventive maintenance and worldwide service

- Worldwide service with over 500 technicians
- Regular inspections and preventive maintenance help avoid machine faults and extend service life
- MDA software informs the machine operator about scheduled maintenance requirements and provides cost transparency for calculation
- TeleServiceNet – our “eye” into the machine avoids costly on-side services
- woodScout diagnostic software - intelligent self-help for all machine operators



For details of other applications, please apply for our **ecoPlus** brochure.



For other applications, please apply for our unit and clamping element catalogue.

Technical data BMG 500/600

Working dimensions

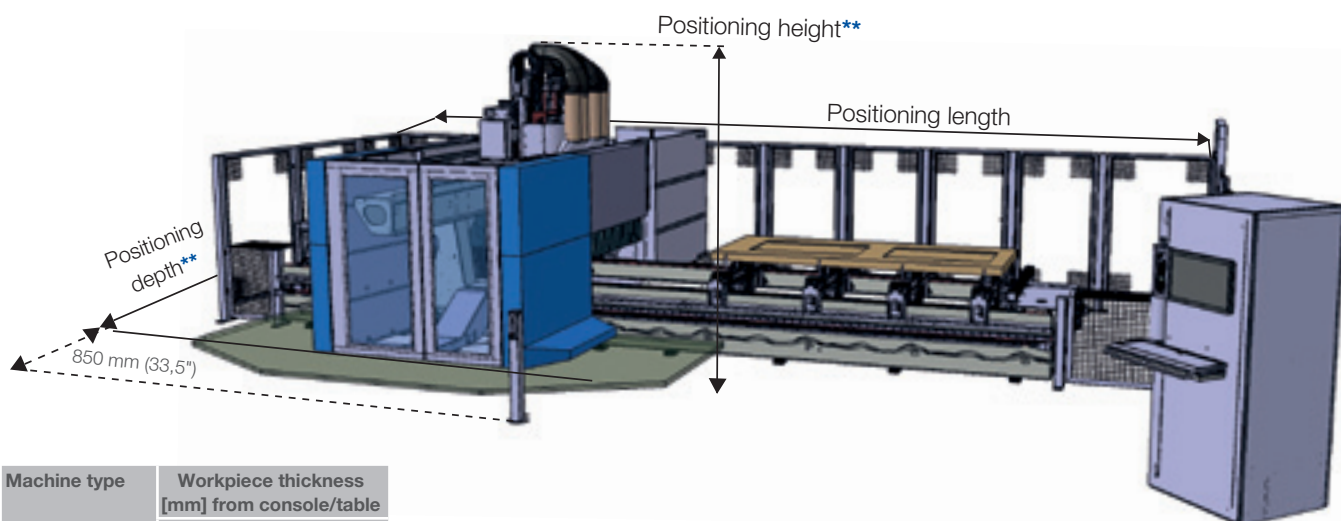

Machine type	Workpiece thickness [mm] from console/table with tool length 230 mm

BMG 5xx 300 (11.8")

BMG 6xx 300 (11.8")
500 (19.7")

Machine type	X = Workpiece length [mm]	
	All units	
	Individual processing	Alternating processing CE*
BMG xxx/33/xx	3 300 (129.9")	1 025 (40.4")
BMG xxx/40/xx	4 000 (157.5")	1 375 (54.1")
BMG xxx/60/xx	6 000 (236.2")	2 375 (93.5")
BMG xxx/74/xx	7 400 (291.3")	3 075 (121.1")

Machine type	Y = Workpiece width [mm]			
	A = 0° all units, A = 90° with tool length 230 mm	A = 0° with tool diameter 25 mm		Gluing (BMG512/V)
		Front stop	Front stop	Rear stop
BMG xxx/xx/12	1 100 (43.3")	1 325 (52.2")	1 550 (61.0")	1 550 (61.0")
BMG xxx/xx/15	1 450 (57.1")	1 675 (65.9")	1 900 (74.8")	1 900 (74.8")
BMG xxx/xx/19	1 800 (70.9")	2 025 (79.7")	2 250 (88.6")	2 250 (88.6")
BMG 511/xx/29	2 800 (110.2")	3 025 (119.1")	3 250 (128.0")	--



Setting up dimensions

Machine type	Positioning length [mm]				Positioning depth [mm]**	Positioning height [mm]**
	33	40	60	74		
BMG 511/xx/12	7 450 (293.3")	8 150 (320.9")	10 150 (399.6")	11 550 (454.7")	4 750 (187.0")	2 980 (117.3")
BMG 511/xx/15	7 450 (293.3")	8 150 (320.9")	10 150 (399.6")	11 550 (454.7")	5 000 (196.9")	2 980 (117.3")
BMG 511/xx/19	--	8 150 (320.9")	10 150 (399.6")	11 550 (454.7")	5 500 (216.5")	2 980 (117.3")
BMG 511/xx/29***	--	--	--	13 050 (513.8")	7 250 (285.4")	2 980 (117.3")
BMG 512/xx/12	7 450 (293.3")	8 150 (320.9")	10 150 (399.6")	11 550 (454.7")	5 650 (222.4")	2 980 (117.3")
BMG 512/xx/15	7 450 (293.3")	8 150 (320.9")	10 150 (399.6")	11 550 (454.7")	5 900 (232.3")	2 980 (117.3")
BMG 512/xx/19	--	8 150 (320.9")	10 150 (399.6")	11 550 (454.7")	6 400 (252.0")	2 980 (117.3")
BMG 512/xx/12/V	7 450 (293.3")	8 150 (320.9")	10 150 (399.6")	11 550 (454.7")	5 450 (214.6")	2 980 (117.3")
BMG 512/xx/15/V	7 450 (293.3")	8 150 (320.9")	10 150 (399.6")	11 550 (454.7")	5 950 (234.3")	2 980 (117.3")
BMG 512/xx/19/V	--	8 150 (320.9")	10 150 (399.6")	11 550 (454.7")	6 200 (244.1")	2 980 (117.3")
BMG 611/xx/12	7 800 (307.1")	8 500 (334.6")	10 500 (413.4")	11 900 (468.5")	4 500 (177.2")	3 400 (133.8") 3 700 (145.7")
BMG 611/xx/15	7 800 (307.1")	8 500 (334.6")	10 500 (413.4")	11 900 (468.5")	4 750 (187.0")	3 400 (133.8") 3 700 (145.7")
BMG 611/xx/19	--	8 500 (334.6")	10 500 (413.4")	11 900 (468.5")	5 250 (206.7")	3 400 (133.8") 3 700 (145.7")

* Dimension with central division. Size of alternating field adjusted to the component size

** Dependent on the machine configuration

*** Available lengths, table and gantry configurations on request

Technical data and photos are not binding in every detail.
We reserve the express right to make changes in the interests of further development.



A member of the HOMAG Group



HOMAG Holzbearbeitungssysteme GmbH

Homagstraße 3-5
72296 SCHOPFLOCH
GERMANY

Tel. +49 7443 13-0
Fax +49 7443 13-2300
info@homag.de
www.homag.com