



LCR macchine automatiche srl

via del Lavoro 5, 40050 Castello D'Argile Bologna Italy

tel.: +39 051 976434

fax.: +39 051 976624

sales@lcrgroup.it

www.lcrgroup.it

LCR macchine automatiche srl

Cutting-creasing machine Modular 2800

Corrugated cardboard self-adjusting Cutting-creasing machine with high performances



Cardboard sheets

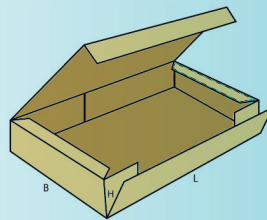
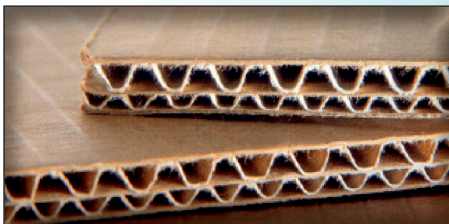

Fan fold cardboard

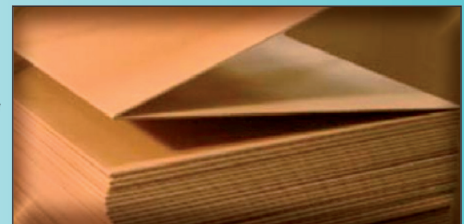

Multiple fan fold cardboards

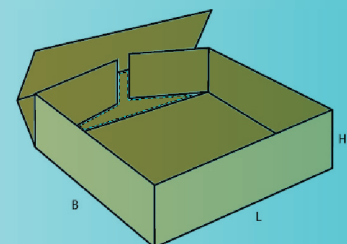
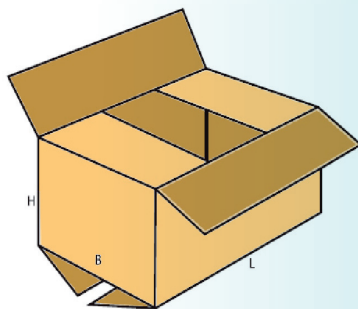

Cutting-creasing machine with automatic feeder and multiple fan fold cardboards

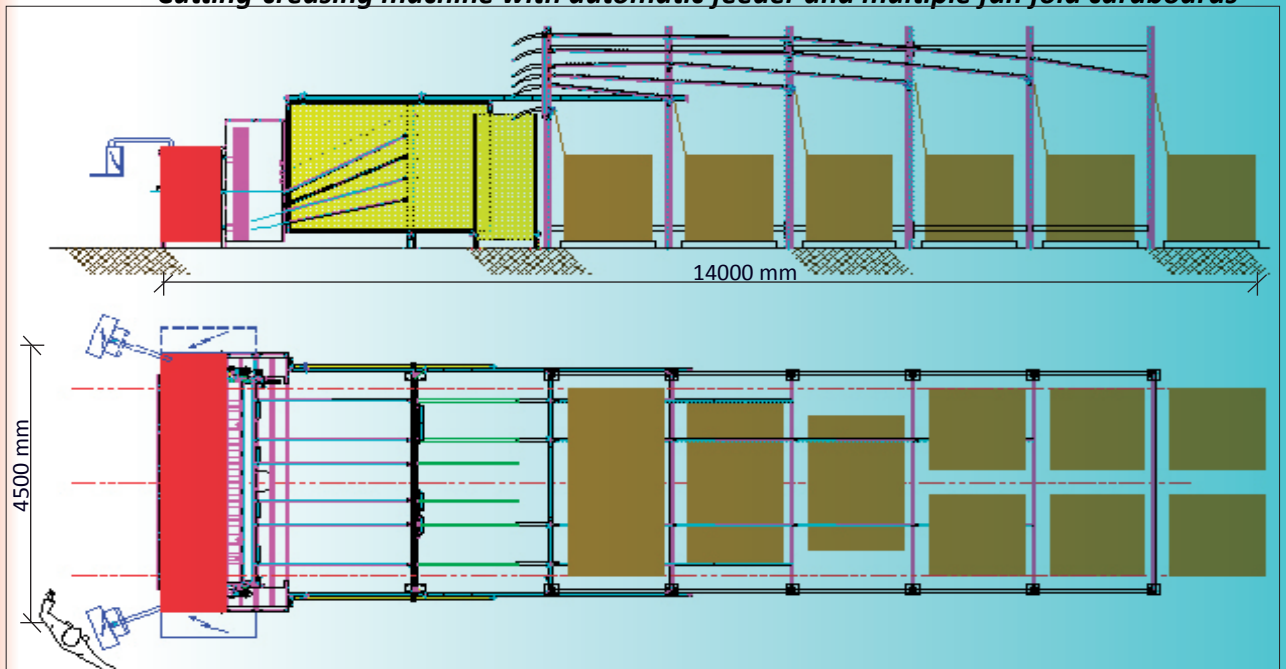

Single fan fold cardboard

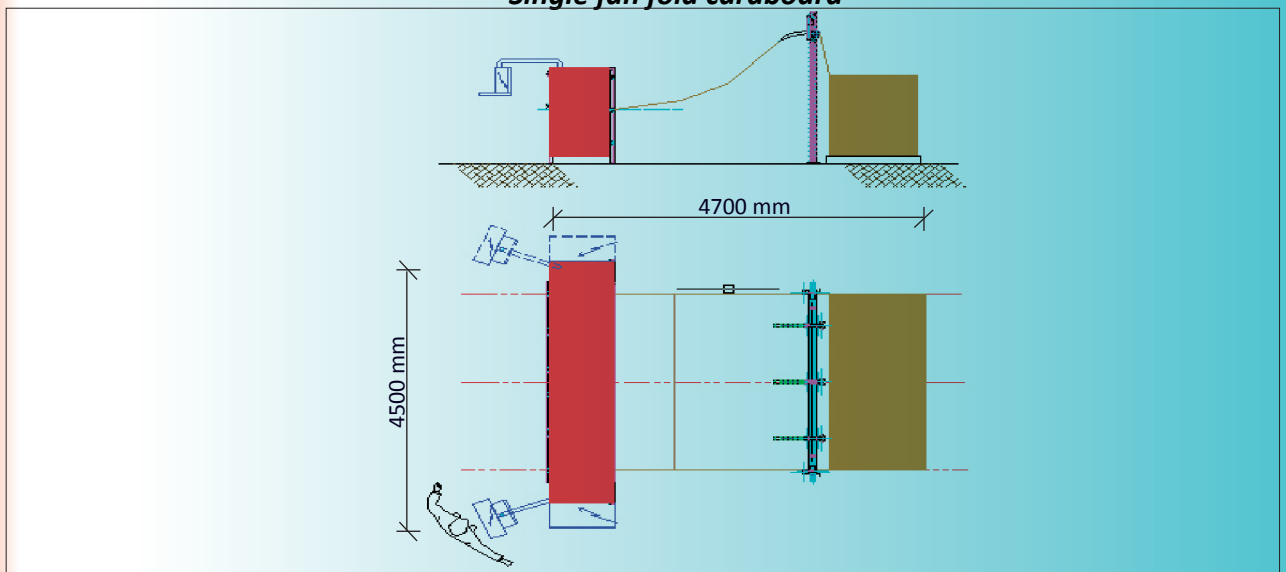

Manual / Automatic introduction of the sheets

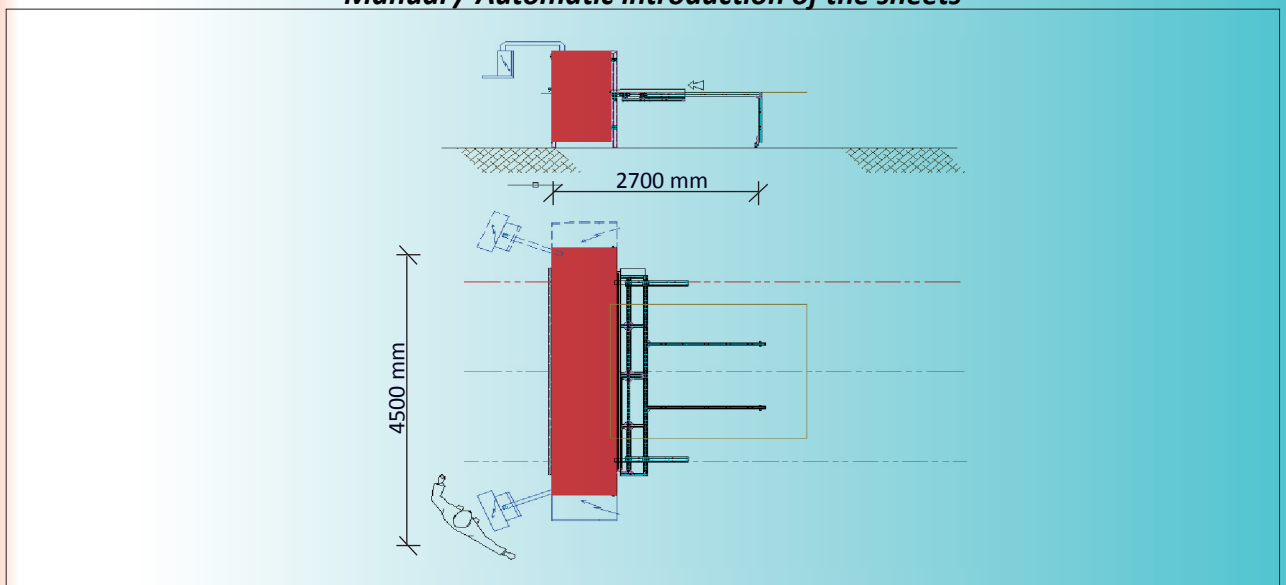

Cutting-creasing machine Modular 2800

Highly-flexible automatic self-adjusting cutting-creasing machine
 Custom made boxes "just in time"

Modular configuration

- Number of the axis / cutting-creasing groups on demand
- Fan fold cardboard / Cardboard sheets
- Multiple widths of fan fold cardboards / Sheets
- Two production modalities: single boxes in sequence or multiple boxes placed side by side
- Simultaneous production of different types and dimensions
- Adjustable operator panel with PC
- CAD/CAM system with box's library FEFCO/LCR
- Function to acquire production lists by uploading/downloading from Host (AS400, SAP, Server SQL)

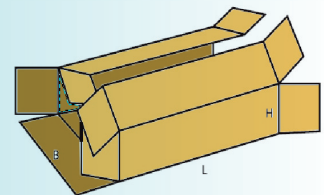
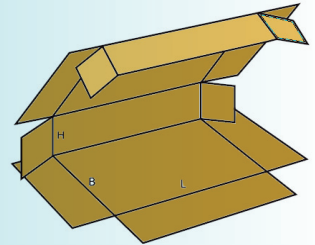

Technical features

- Production from 10/11 boxes/min. up to 30/33 boxes/min.
- Cardboard types A,B,C,K,BA,BC,EB (thickness from 1,5 up to 7 mm, mono/double wave)
- Max. cardboard width: 2800/3300 mm
- Max. cardboard length: endless
- Hardware: Siemens Simotion
- Software: CAD/CAM system LCR

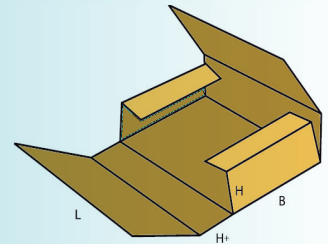

User interface

Production management and report

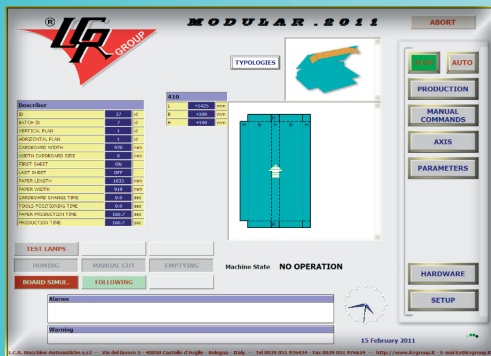

Box library

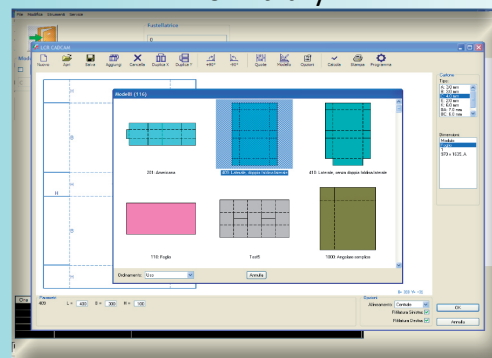

Multilingual interface



Input /output

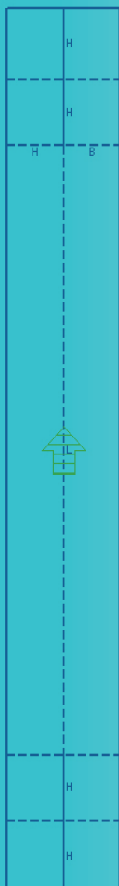
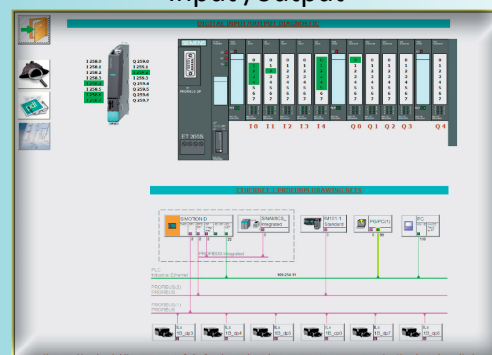

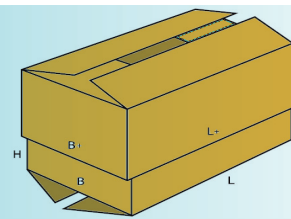
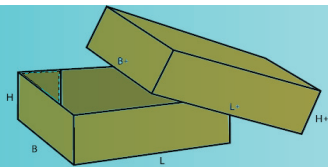
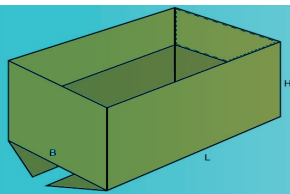

Optional

- Shredders/Conveyors for the cardboard's wastes
- Automatic systems for the introduction of single cardboard sheets
- Custom-made boxes: high/low resolution direct printing on the cardboard "print & apply" labelling machines
- Creasing with perforation
- Slotting
- Use of fixed scanner or radio-frequency scanner to read bar codes
- Die-cut devices to create handles
- Software to create new types of boxes
- Automatic adjustment of the creasing pressure

Shredders for the cardboard wastes



Perforation

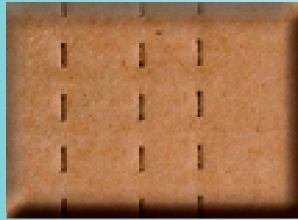

Slotting

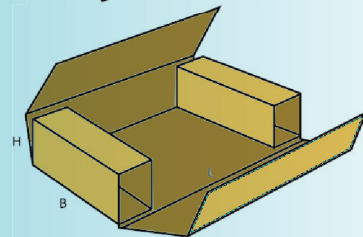
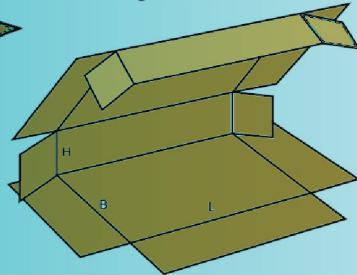
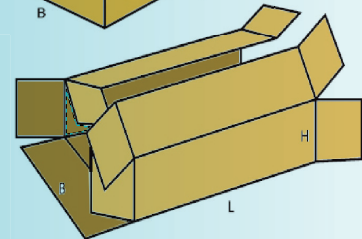
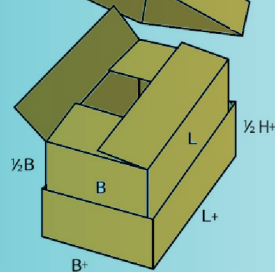
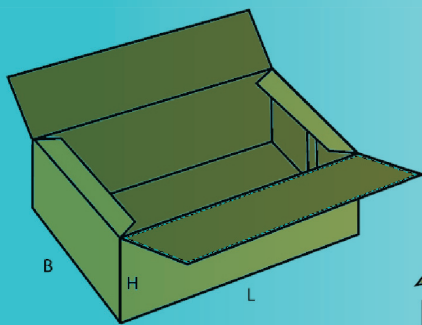
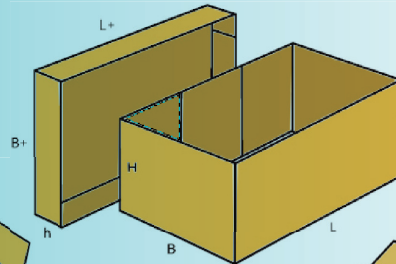
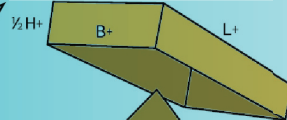
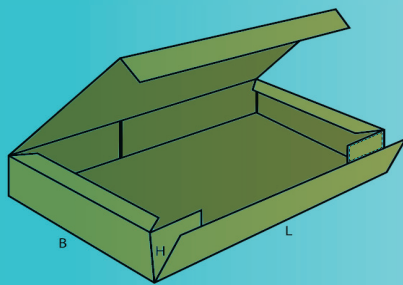
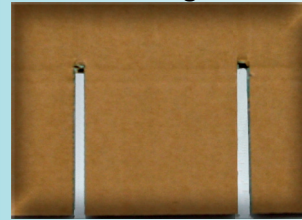

LCR machine automatiche srl

via del Lavoro 5, 40050 Castello D'Argile Bologna Italy

tel.: +39 051 976434

fax.: +39 051 976624

sales@lcrgroup.it

www.lcrgroup.it