

Edge banding machines

Highflex 1650 - 1890

KDN/F 1630 - KDN/F 1895 profiLine



HOMAG Group

Success by partnership

To survive in a fiercely competitive market, a company has to have fast, flexible and efficient production. The HOMAG Group, with its sales and service network in over 80 countries around the world, offers you and your employees a strong partnership no matter where you are. The HOMAG Group of companies cover all areas of woodworking and wood-processing. Panel sizing, sawing, edge technology, transportation technology and handling systems are just a few of our specialties.

We also offer solutions for drilling, coating technology, surface technology, plants for doors and doorframes, timber house construction, sanding technology, automation systems, packaging equipment and software. We provide a complete and innovative range of products and services that are always the perfect solution for any requirement.

You, our customers, benefit from high precision, performance and cutting-edge technology.



**„With us, you and your products come first.
A promise that you can count on!“**

BRANDT

Perfect edges for demanding customers

We offer our customers innovative and powerful edgebanding machines. Efficiency and quality have the highest priority, and ensure long-term competitive advantages for you.

With an annual production of over 2000 edgebanding machines, we are the edgebanding specialist in the Homag Group and the world leader in our market segment.

A high degree of standardization in combination with an advanced manufacturing process and more than 50 years of engineering experience

ensure state of the art quality at a superb price-performance ratio. Our clear and structured product range is designed to meet the demands of current and future market trends. All of our developments are focused toward practically-oriented and economic solutions that guarantee you the best possible production results.

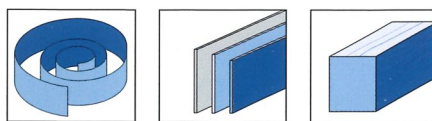
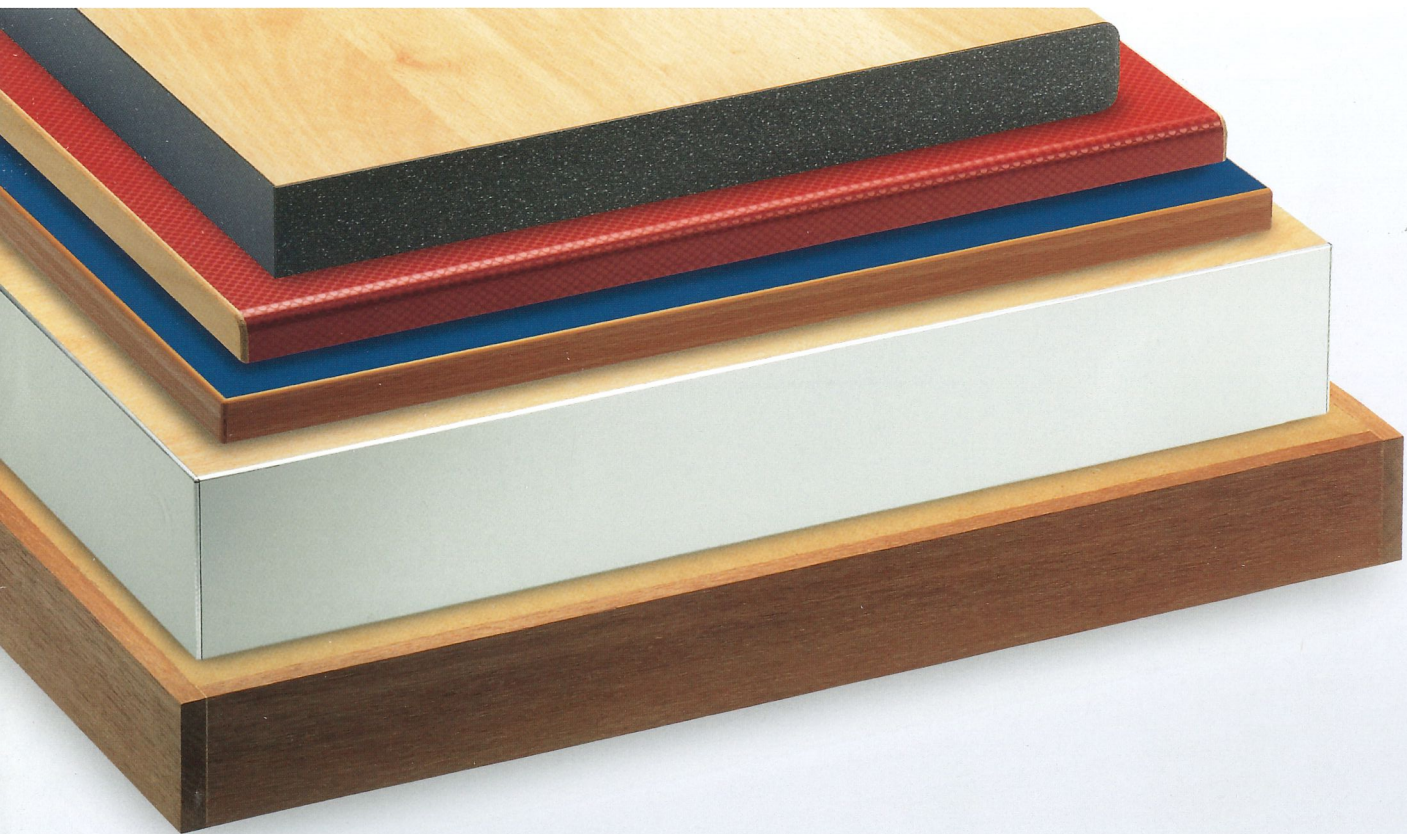

mm	Coil	Strips	Solid
a		min. 70	
b		8 - 60 (option 80/100)	
c		0,4 - 12 (option 20)	
d		65 (option 85/105)	
e		max. 30	

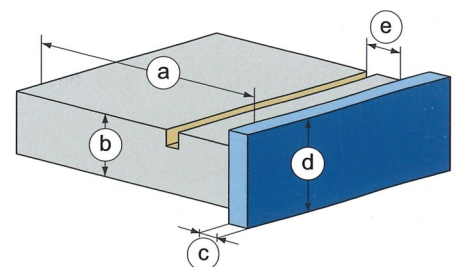

„Ideal prepared for your requirements“

Highflex & profiLine series

Precision and performance for the most demanding jobs

The Highflex series is characterized by its high degree of automation and well equipped units.

This high level of flexibility allows perfect focus on your needs and guarantees perfect edges.

Because of its modular design and the freely-fittable frame concept, it is possible to configure perfectly tailor-made machines according to specific requirements.

The characteristics of all BRANDT machines are combined in these two series to make them perfectly-equipped for any job

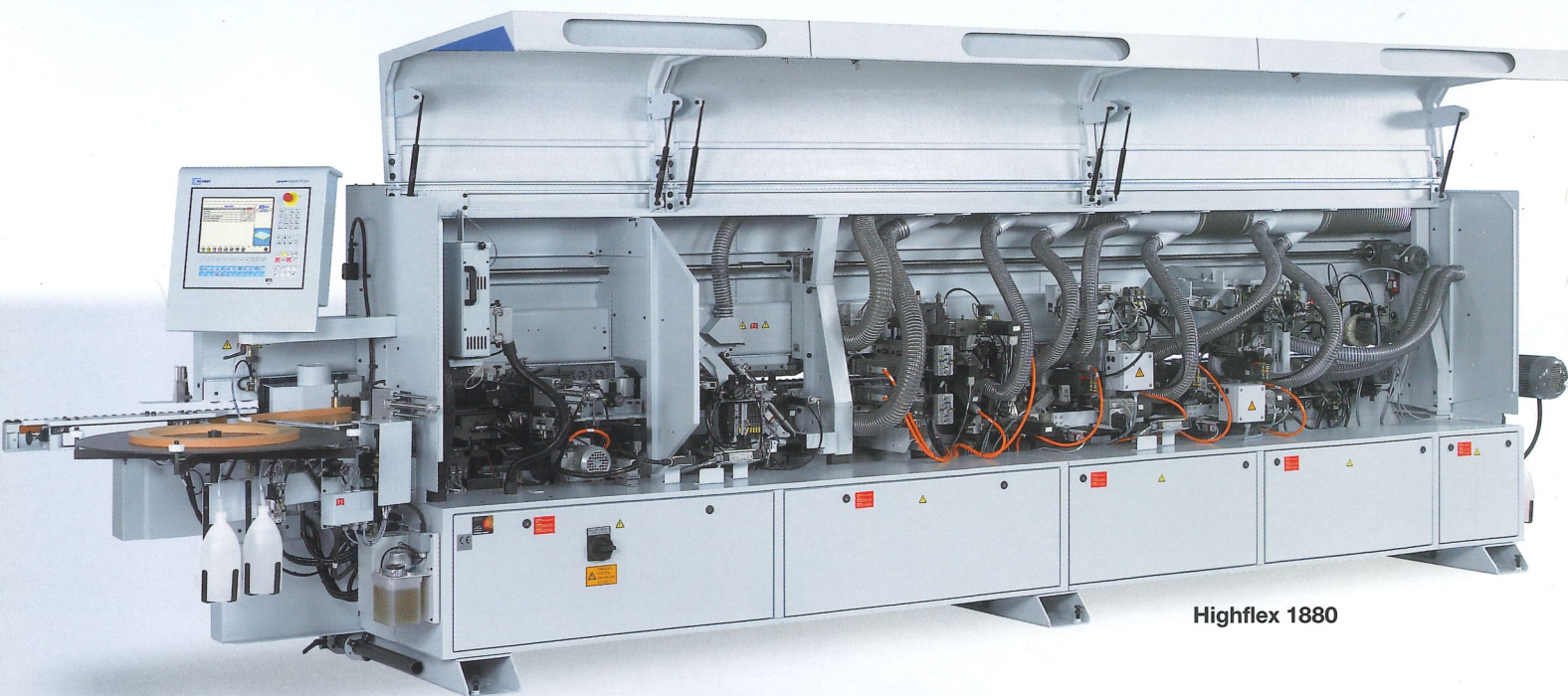

Highflex 1880

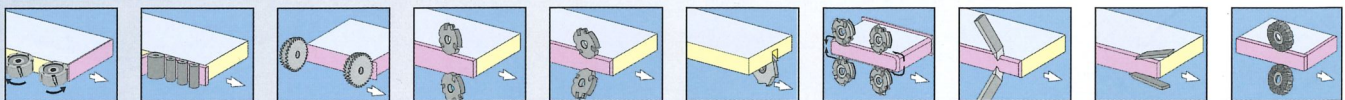

The right solution for your requirements

The Highflex & **profiLine** series machine leaves nothing lacking.

Whether your needs are a demanding shop setting, "batch size one" production for custom requests, living & bedroom furniture or functional office furniture, the Highflex & **profiLine** Series always offers the right solution for your requirements.



The controller – Quality and precision with the touch of a button

Through targeted and constant development of controller technology, simple operation and a high operating comfort are guaranteed.

At BRANDT we focus on you as our customer and your finished product.



Highflex 1660



PowerControl PC 20+, offering every "plus" for the customer

- + Optimum overview by using a big 12" screen
- + High operator comfort with all functions button-controlled from the operating panel
- + Short set up times, through high controller capacity and easy selection of processing programs
- + Self-explanatory operator guidance, through a graphic interface and optimum visualisation
- + Easy Back-up function of the entire control and all operator programs
- + Network-compatible
- + Context-sensitive help - detailed information about the functions and how to operate the machine directly on the screen
- + Compilation of production data for detailed gathering of job related costs

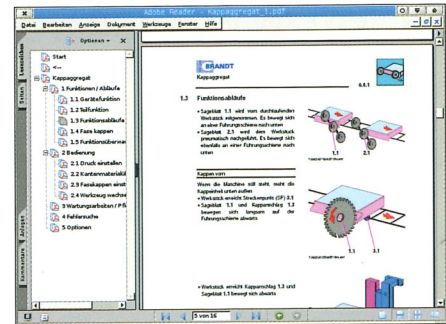

Context-sensitive help

With the context-sensitive help function, it is possible to directly display detailed information on the operations and functions of the machine.

The controller-integrated help functions are accessible with the push of a button from the keyboard and allow for immediate operator support.

Compilation of production data via the BRANDT-Browser

Compiled production data can be easily gathered and saved.

The BRANDT-Browser allows for job-specific collection of operating hours, an overview of the total processed workpieces and information regarding total meters of processed edges.

For companies that have large numbers of different clients, it is especially advantageous to always have an accurate record of contract-related costs.

Significant competitive advantages – Pace setting performance and quality. Highflex 1650 + 1660

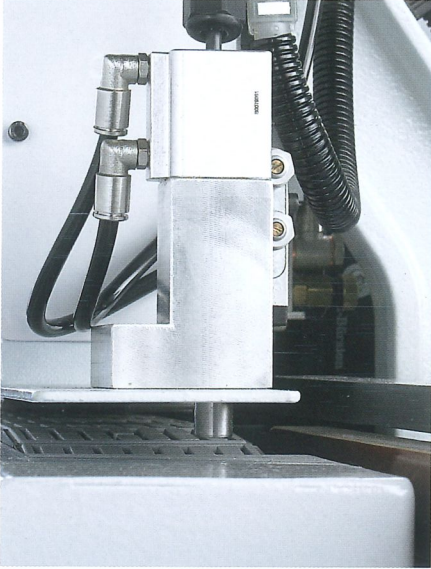

Infeed stop

For minimum workpiece spacing and safe operation.



Joint trimming unit

Perfect cut and high operating life due to diamond tipped tools for an optimum edge joint quality.



Extra wide magazine (optional)

Extra wide magazine with high capacity for fixed length strips and optimum access to reload.

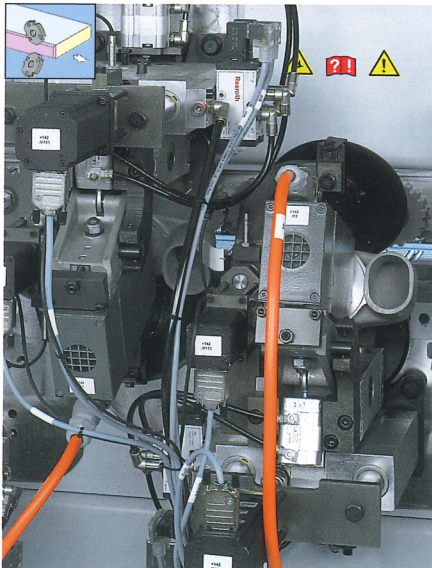

Trimming unit

Multi-functional trimming unit with DFC tool technology for optimum extraction. Equipped with servo axis to adjust the unit automatically to edge thickness and profile.



Multifunctional trimming unit (optional)

Trimming of the edge overhang on top and bottom side as well as contour trimming on the front and rear edges. Equipped with an automatic adjustment to switch between thick and thin edges. Workpiece thickness up to 60mm.



Radiant heater

Strong adhesion through optimal pre heating of the workpiece.

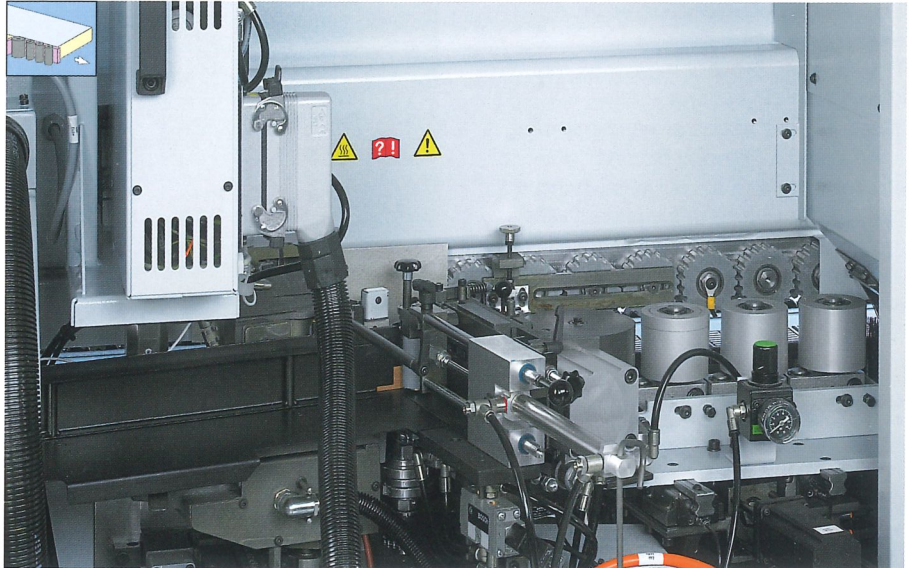

Magazine

Coil and automatic strip magazine with optical edging material monitoring for a reliable material supply. Equipped with a Quick-melt gluing unit.

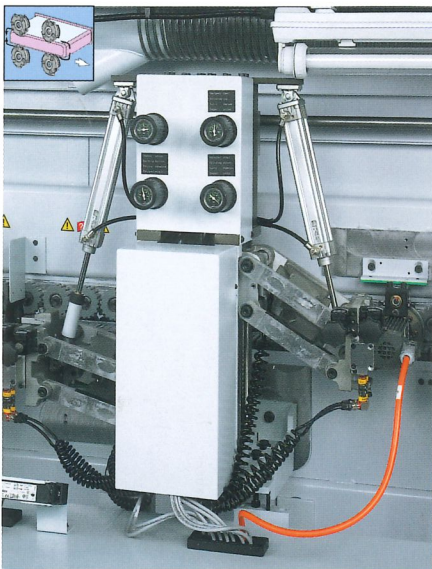

Corner rounding unit

For corner rounding of thick PVC edges, as well as postforming and softforming profiles. Equipped with automatic adjustment between thin and thick edge material.

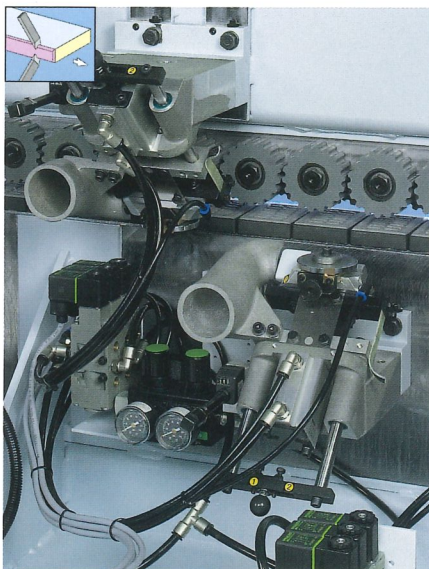

Profile scraping unit

Unit to smooth radii or chamfers, equipped with quick change heads for fast profile change.



Glue joint scraping unit

For the perfect finish and for edge scraping up to 0,3mm.

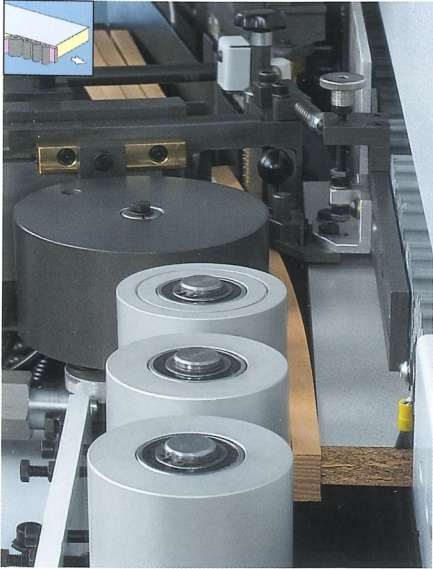

Pressure zone

Heavy pressure zone (up to 12 mm) to ensure an optimum glue joint quality.

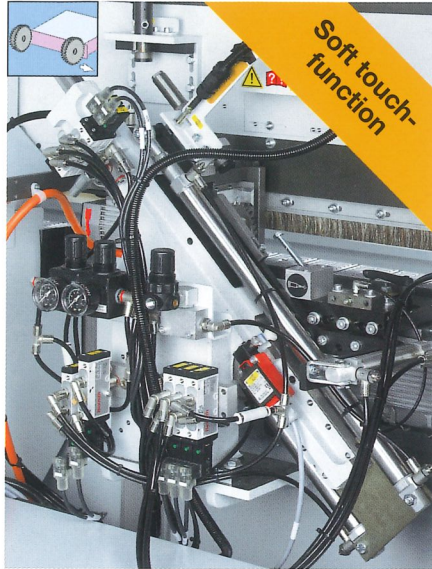

End trimming unit

Perfect cutting by the end trimming unit using rigid high-precision linear guides and the workpiece gap optimization package to achieve higher output in the same processing time. Soft-touch for optimal end trimming results even at high speeds.

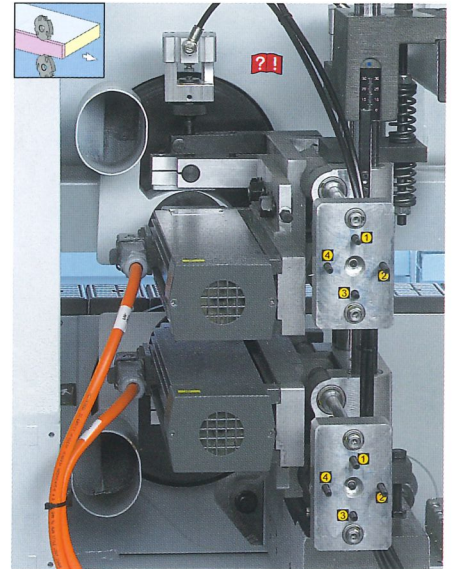

Rough trimming unit

For rough trimming of all common edgebanding materials.



Buffing unit

Buffing unit to polish edges and maintain their natural color.

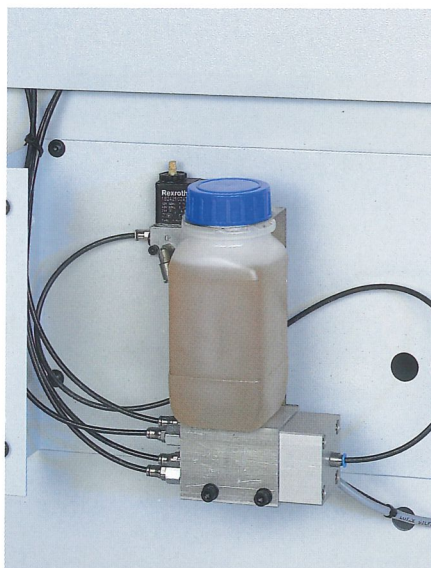

Central lubrication unit

Fully automatic lubrication of the feed track guidance system to guarantee precision and a long-life time of the conveyor chain.

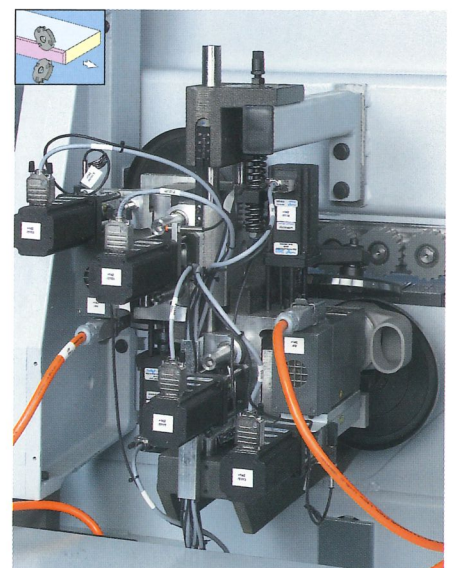

Multistage trimming unit

Highly flexible unit concept, equipped with servo axis technology, allows fast change over between 4 different trimming profiles.

Significant competitive advantages – Pace setting performance and quality. Highflex 1880 + 1890

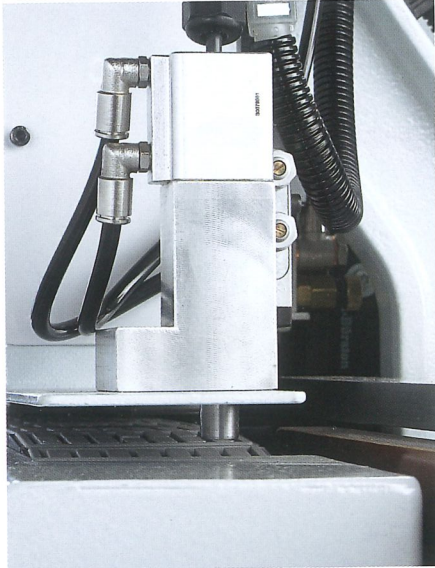

Infeed stop
For minimum workpiece spacing
and safe operation.

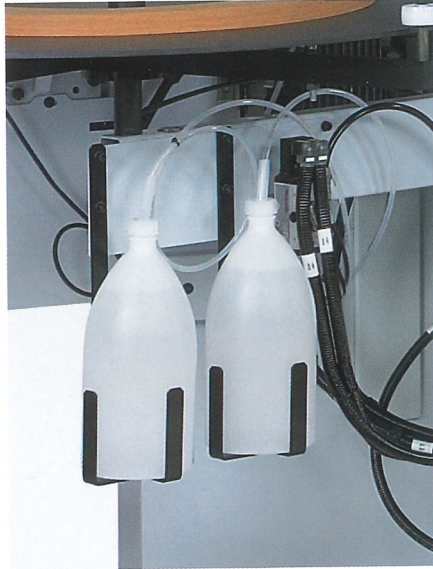

Spraying unit
Separation and detergent agents for a
perfect finish when processing PUR-glue.



Joint trimming unit
Perfect cut and high operating life due
to diamond tipped tools for an optimum
edge joint quality.

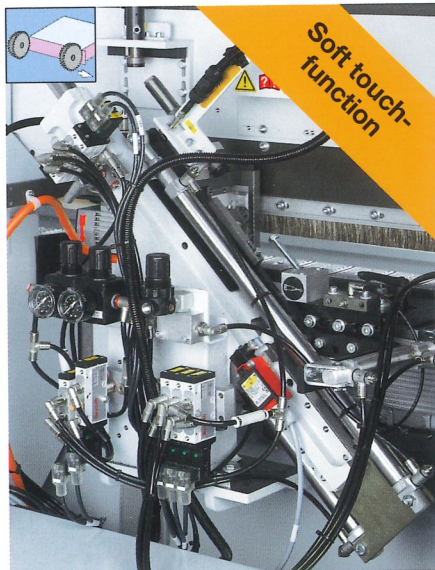

End trimming unit
Perfect cutting by the end trimming unit
using rigid high-precision linear guides
and the workpiece gap optimization
package to achieve higher output in the
same processing time. Soft-touch for
optimal end trimming results even at high
speeds.

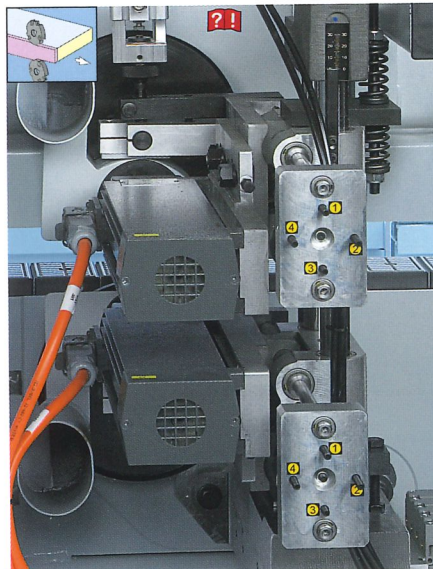

Rough trimming unit
For rough trimming of all common
edgebanding materials.

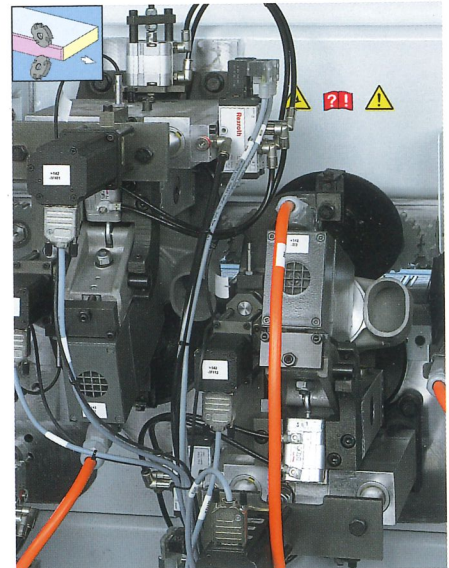

Trimming unit
Multi-functional trimming unit with DFC
tool technology for optimum extraction.
Equipped with servo axis to adjust the
unit automatically to edge thickness and
profile.

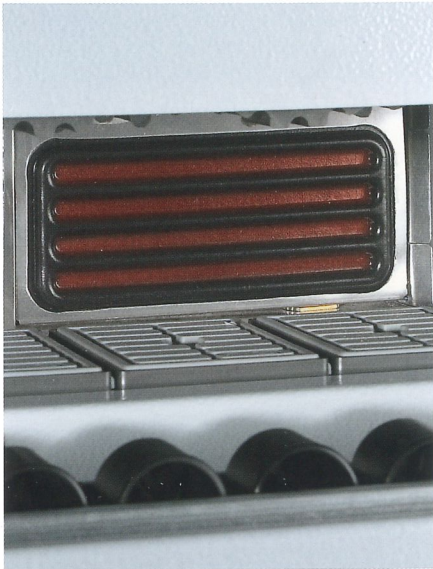

Radiant heater

Strong adhesion through optimal pre heating of the workpiece.

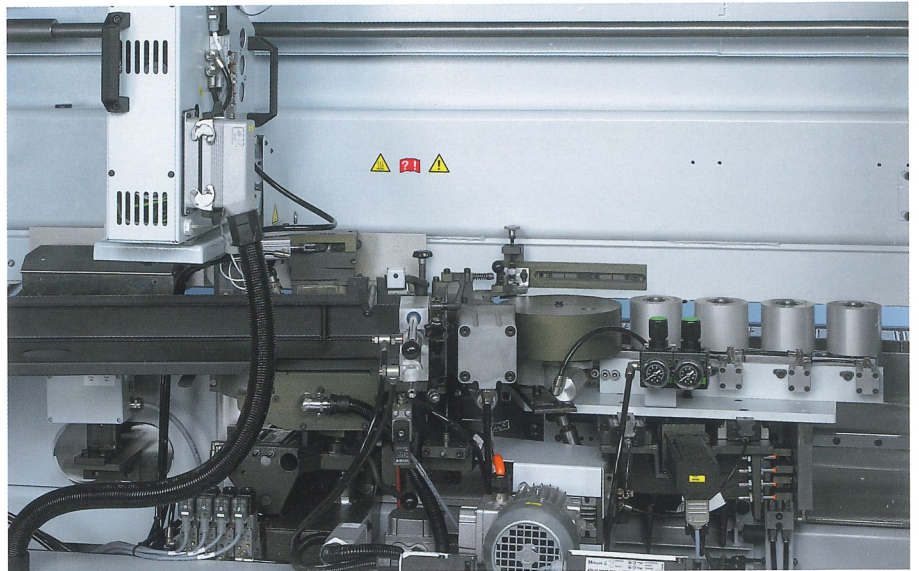

Magazine

Coil and automatic strip magazine with optical edging material monitoring for a reliable material supply. Equipped with a Quick-melt gluing unit.

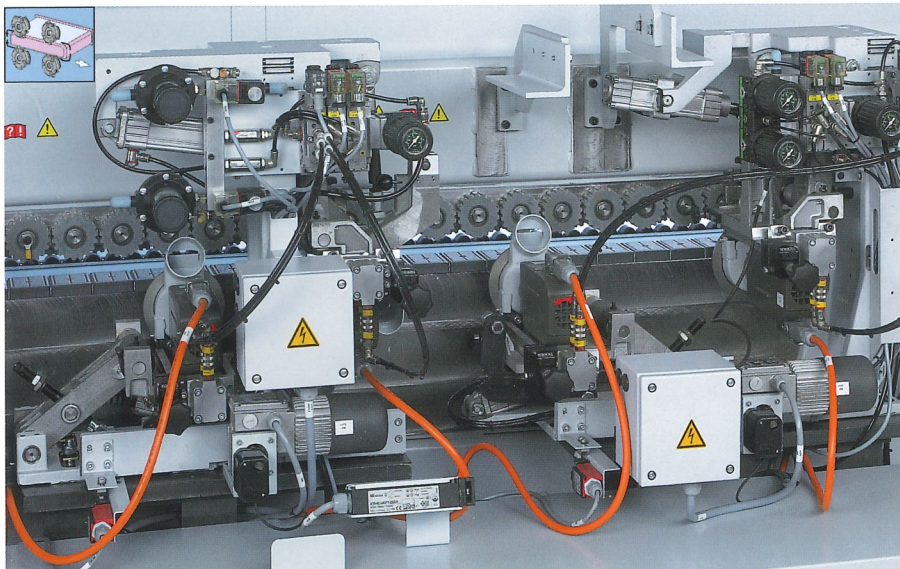

Corner rounding unit (4 motors)

For corner rounding of thick PVC edges, as well as postforming and softforming profiles at feed speeds of up to 20 m/min. Equipped with servo motor adjustment for different edge thicknesses.

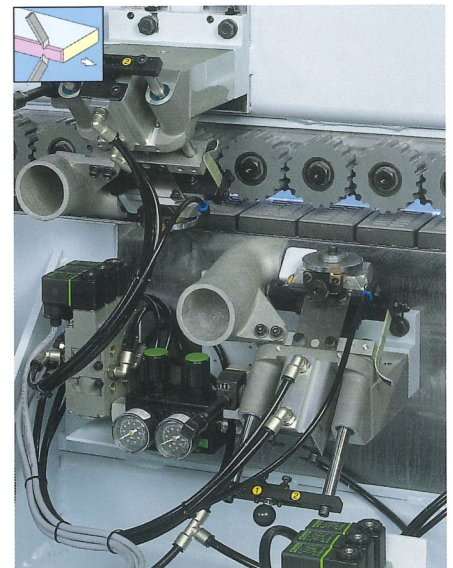

Profile scraping unit

Unit to smooth radii or chamfers, equipped with quick change heads for fast profile change.

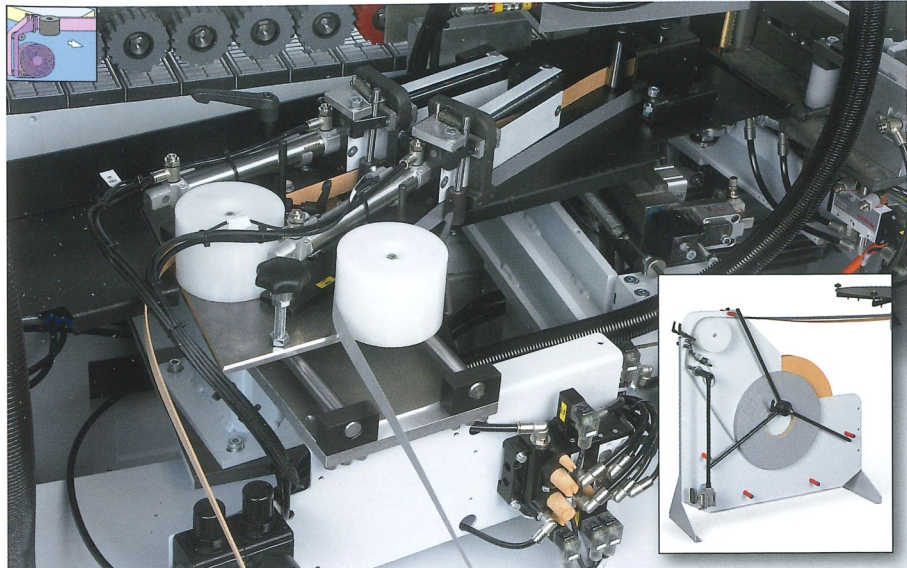

Automatic 2-coil magazine (Highflex 1890)
Automatic 2-coil magazine for the highest possible flexibility and significant time savings during edge material changeovers.



Pressure zone
Heavy pressure zone (up to 20 mm) to ensure an optimum glue joint quality.

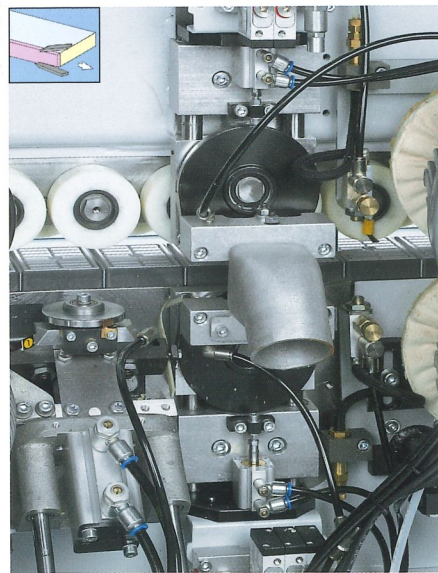

Glue joint scraping unit
For the perfect finish and for edge scraping up to 0,3mm.



Buffing unit
Buffing unit to polish edges and maintain their natural color.



Central lubrication unit
Fully automatic lubrication of the feed track guidance system to guarantee precision and a long-life time of the conveyor chain.

Technical Data – Highflex

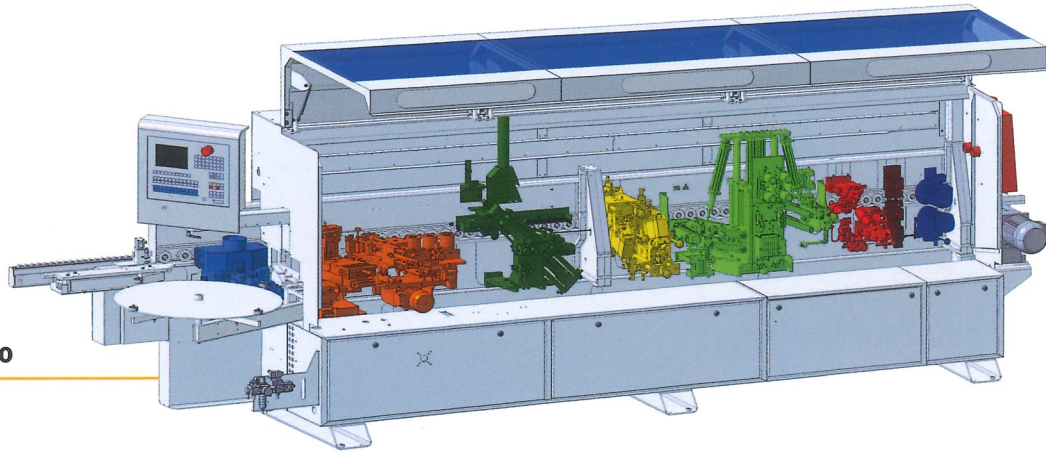
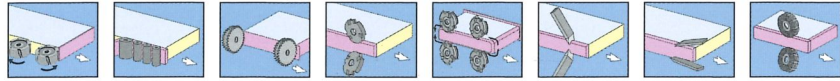

Highflex 1650

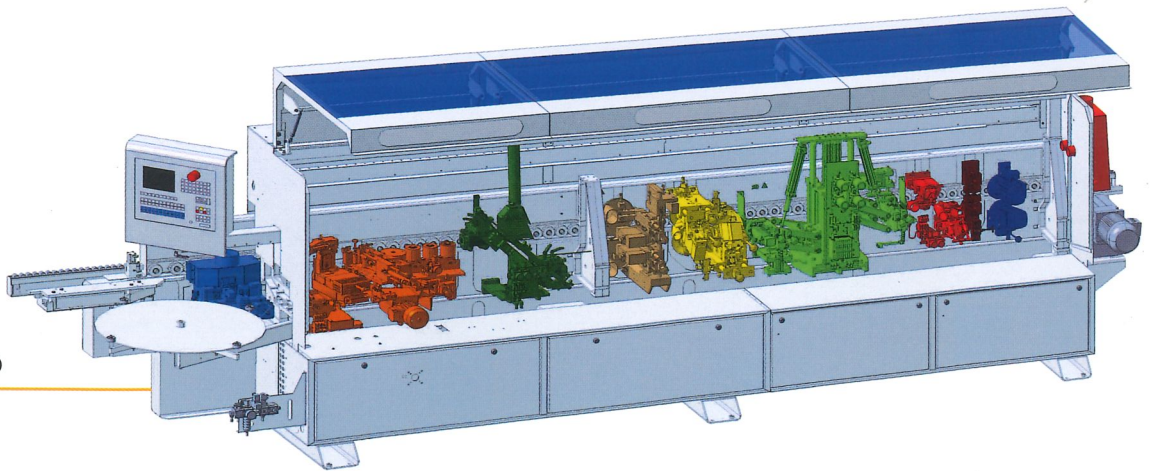
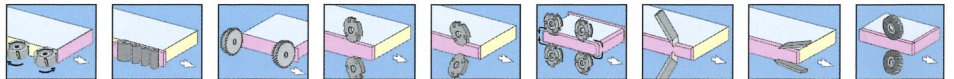

Highflex 1660

	Highflex 1650	Highflex 1660
	Machine dimensions	
Machine length (mm)	5760	6260
Working height (mm)	950	
Machine dimensions WxH (mm)	1560 x 2300	
	Working dimensions	
Workpiece thickness (mm)	8 - 60	
Edge material thickness (mm)	0,4 - 12	
	Miscellaneous	
Feed speed (m/min)	var. 8 - 18	
Weight (kg)	2600	3000
Connected value (kW)	14	15,5
Extraction diameter (mm)	1x120/2x100	1x120/1x160/1x100
Electrics	400 V - 3 Ph. - 50 Hz.	
Pneumatics (bar)	6	

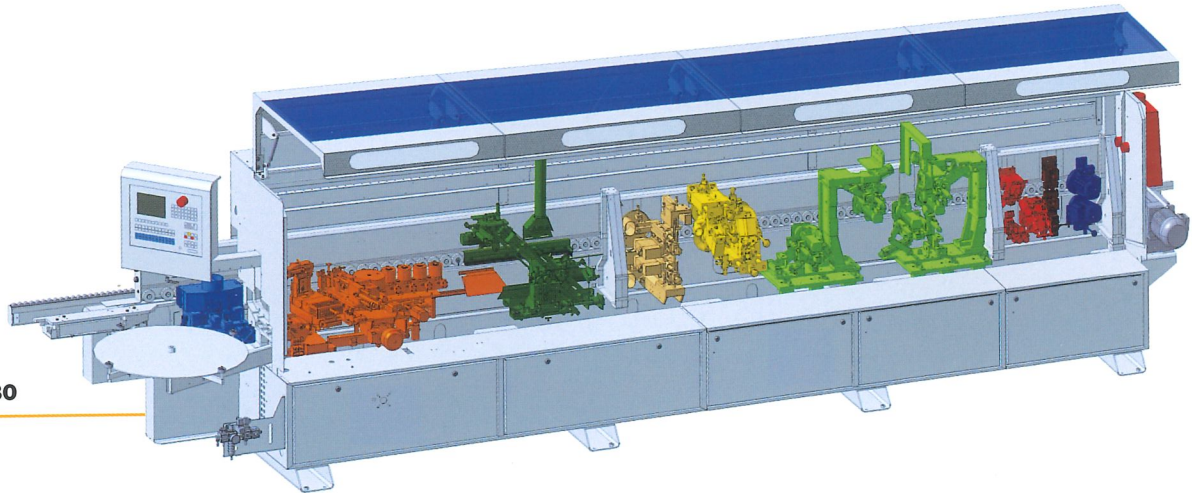
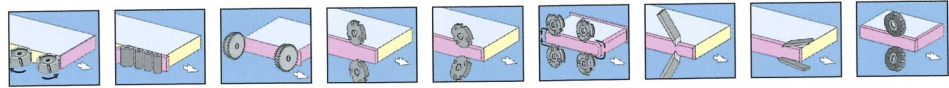

Highflex 1880

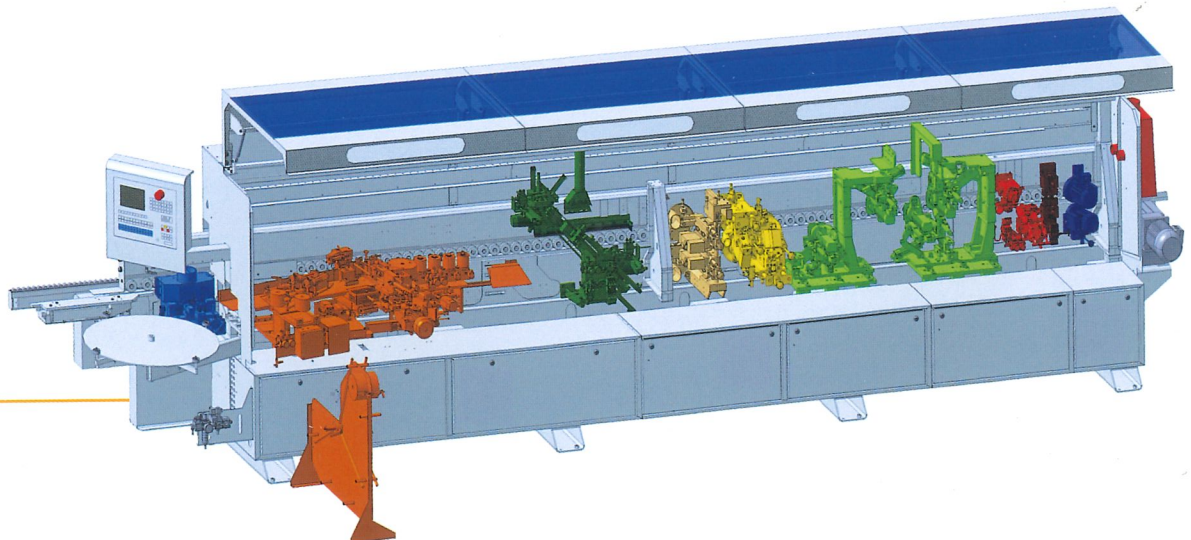
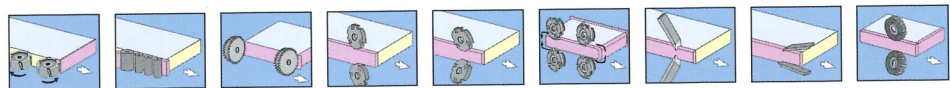

Highflex 1890

	Highflex 1880	Highflex 1890
	Machine dimensions	
Machine length (mm)	7260	7760
Working height (mm)	950	
Machine dimensions WxH (mm)	1560 x 2300	
	Working dimensions	
Workpiece thickness (mm)	8 - 60	
Edge material thickness (mm)	0,4 - 12 (opt. 0,4 - 20)	
	Miscellaneous	
Feed speed (m/min)	vari. 8 - 20	
Weight (kg)	3400	3800
Connected value (kW)	16,5	
Extraction diameter (mm)	1x100/1x200/1x120	
Electrics	400 V - 3 Ph. - 50 Hz.	
Pneumatics (bar)	6	

All rights for technical changes withheld. Individual machine pictures may show options.

Significant competitive advantages – Pace setting performance and quality. profiLine-series



Spraying unit

Separation and detergent agents for a perfect finish when processing PUR-glue.

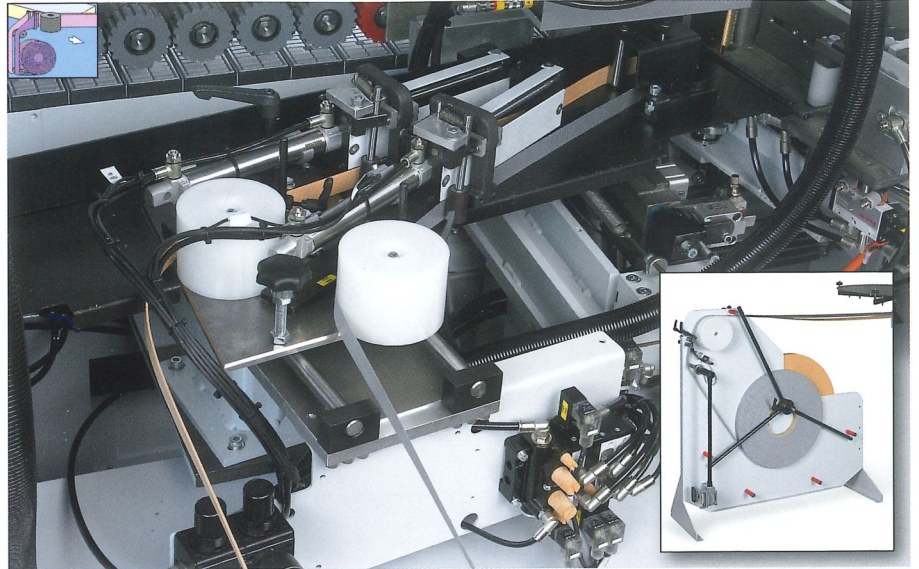

Automatic 2-coil magazine

Automatic 2-coil magazine for the highest possible flexibility and significant time savings during edge material changeovers.



Multifunctional trimming unit

Trimming of the edge overhang on top and bottom side as well as contour trimming on the front and rear edges. Equipped with an automatic adjustment to switch between thick and thin edges. Workpiece thickness up to 60mm.

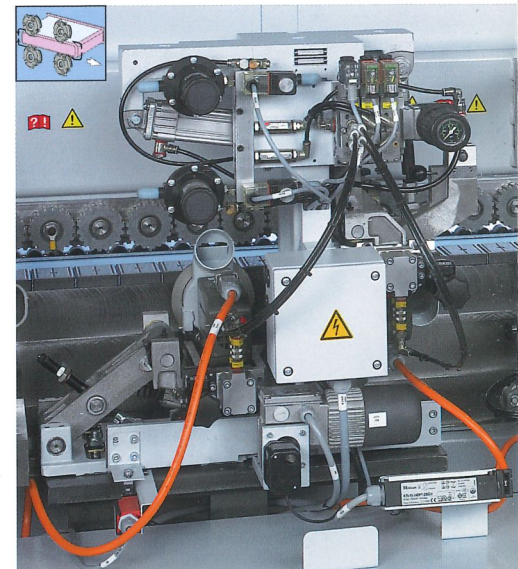

Corner rounding unit (4 motors)

For corner rounding of thick PVC edges, as well as postforming and softforming profiles at feed speeds of up to 20 m/min.



Tiltable grooving unit

For grooving work pieces either from the bottom side or from the edge side. It is possible to do either continuous grooving or non continuous grooving, as well as non continuous grooving for biscuit joints.



Sanding unit

For sanding straight edges on different materials.



Universal trimming unit

Universal unit with high capacity for grooving and profiling work. Flexible by unlimited setting options.

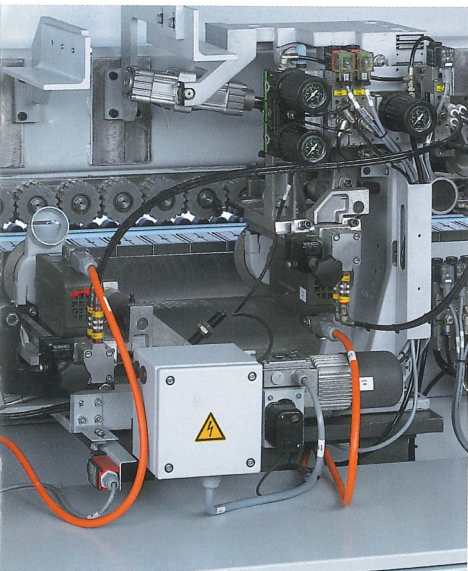

Equipped with servo motor adjustment for different edge thicknesses.

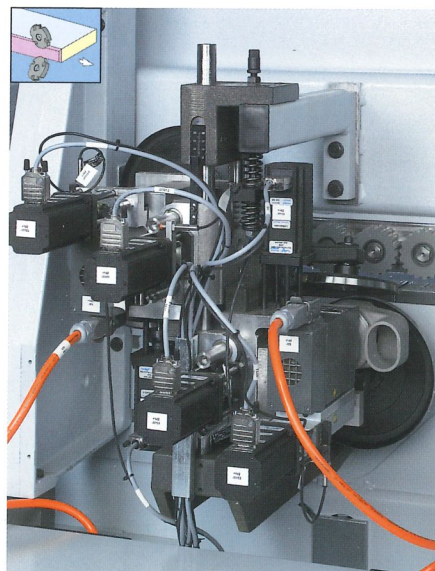

Multistage trimming unit

Highly flexible unit concept, equipped with servo axis technology, allows fast change over between 4 different trimming profiles.

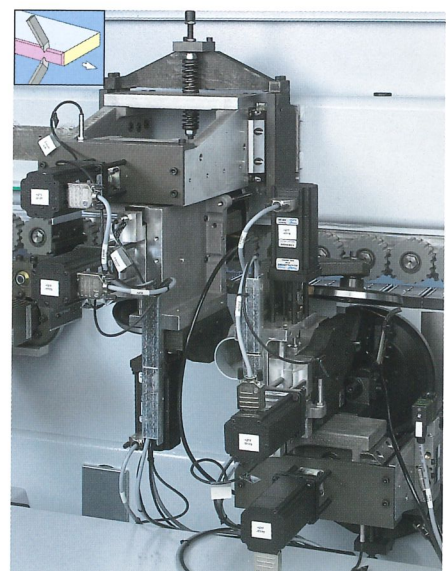

Multistage scraping unit

Technically identical to the Multistage trimming unit, to smooth 4 different profiles.

profiLine series

Precision and performance for highest demands

Our **profiLine** series offer always the perfect solution for your needs. Its modular design and the freely-fittable frame concept allow it to fit perfectly to your production requirements. Workpiece thicknesses of up to 100 mm can be processed, allowing you to keep up with current and future trends in the industry. A universal trimming unit as well as a multi-stage trimming unit highlight the versatility of this machine series. The universal trimming unit offers high performance for grooving and profiling, and can be used in a

very flexible manner. The multi-stage trimming unit is equipped with servo-axis adjustments and allows for automatic changeover between four different profiles. A belt sanding unit with multiple pad capabilities is available for sanding of straight edges and radii.

„You define the task – we configure the right machine“

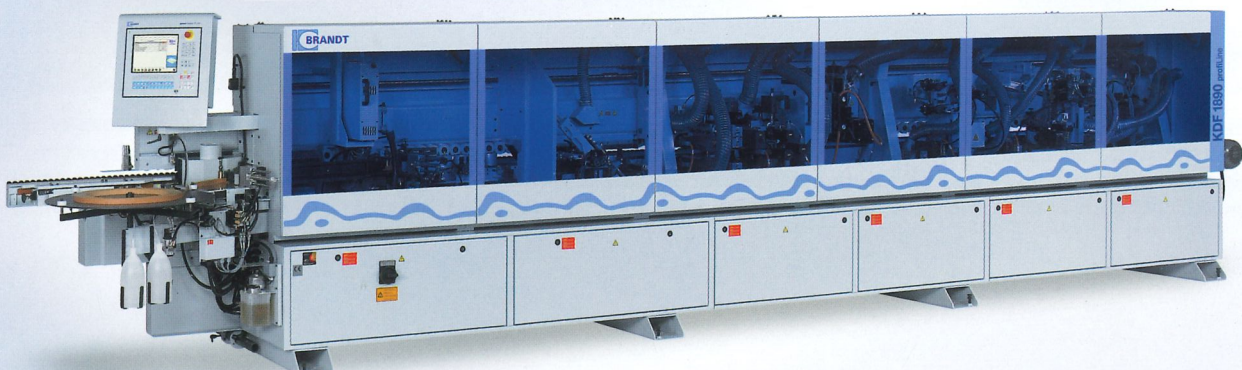

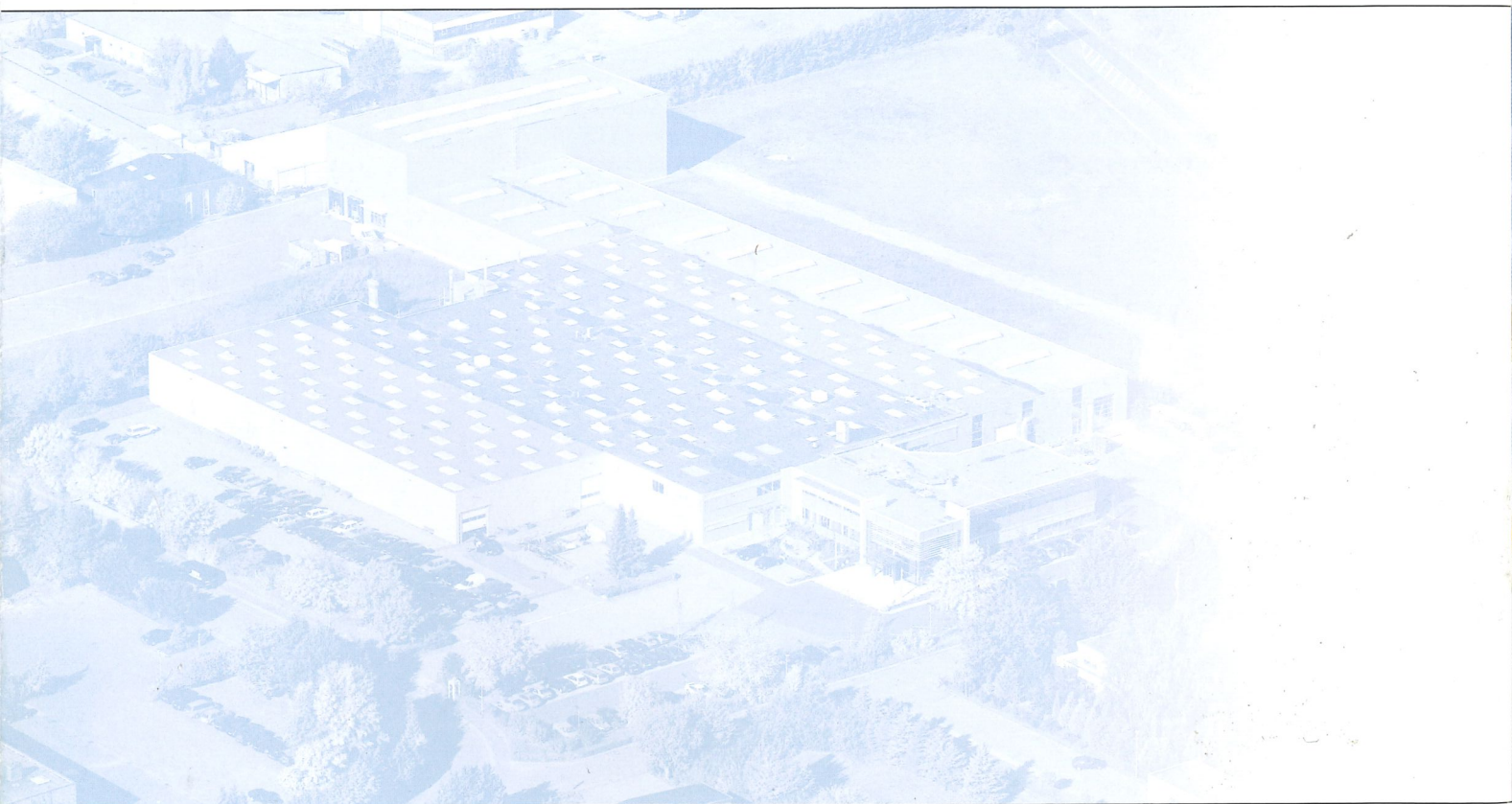

A member of the Homag Group of Companies



BRANDT
Kantentechnik GmbH
Weststraße 2
32657 Lemgo
Germany
Tel. +49 5261/974-0
Fax +49 5261/6486
info@brandt.de
<http://www.brandt.de>

