

Edge banding machines

Optimat KDN 630 - KDF 670 2C

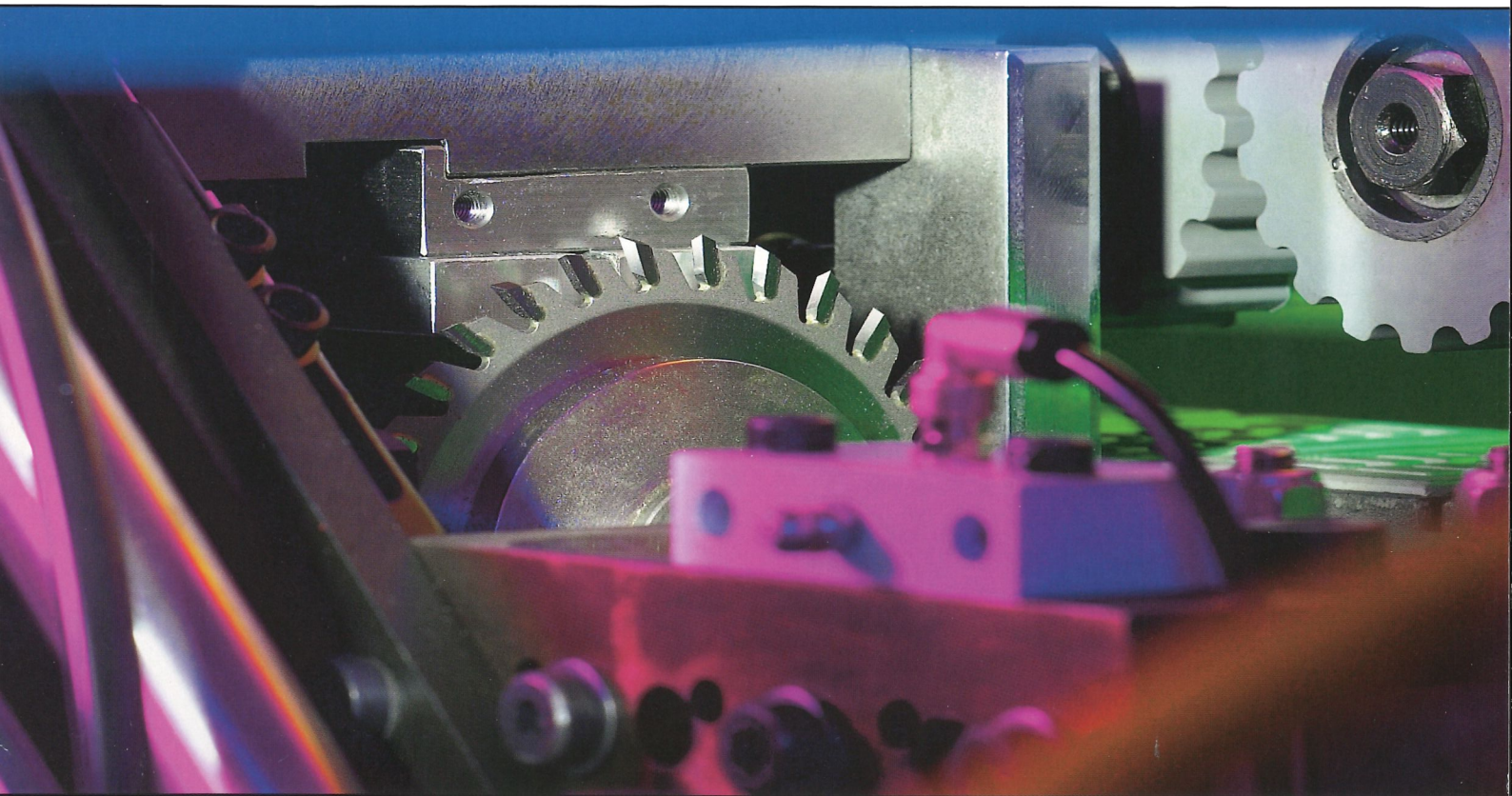

Sophisticated edges for sophisticated customers

Optimat: Hi-Tech needn't cost more

In the Optimat range the Homag Group presents a new generation of machines for the wood processing industry and woodworking, which are even more tailored to the requirements of our customers. All Optimat machines share the same leading edge technology, the same legendary quality and the reliability associated with the Homag Group.

And since Optimat machines are produced in series, you can also reap the financial benefits.

Pioneering machine design

Besides its groundbreaking technology, the new Optimat equipment also sets new standards in machine design, guaranteeing maximum value retention over many years.

Intelligent automation

Life today without electronics would be unimaginable. The new range is equipped with the following as standard:

- Electronic line control
- Electronic frequency changer, wear-free with integrated motor brake
- Chain track central lubrication
- Electric hot melt temperature monitoring with automatic temperature lowering during longer pauses in operation
- Internal modem for the possibility of using remote diagnostics
- comfortable IPC-Control

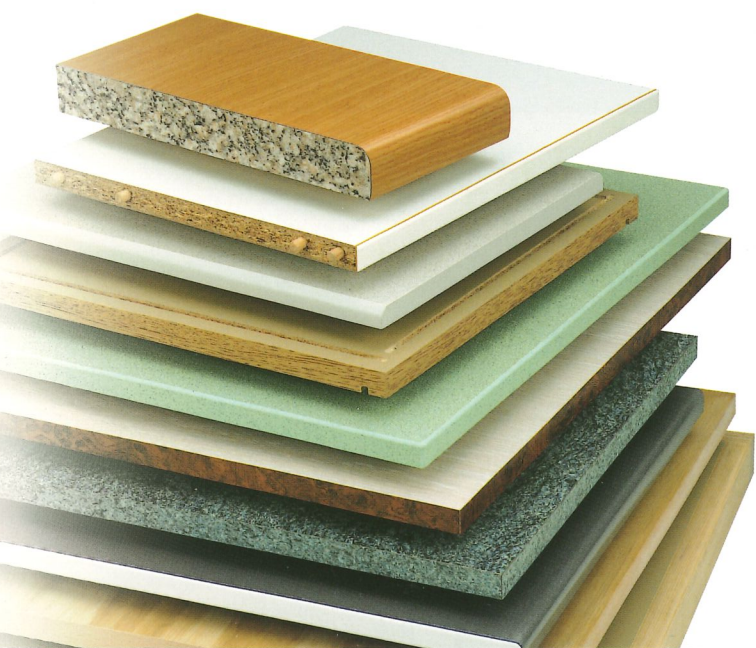

Optimat KDF 660 C

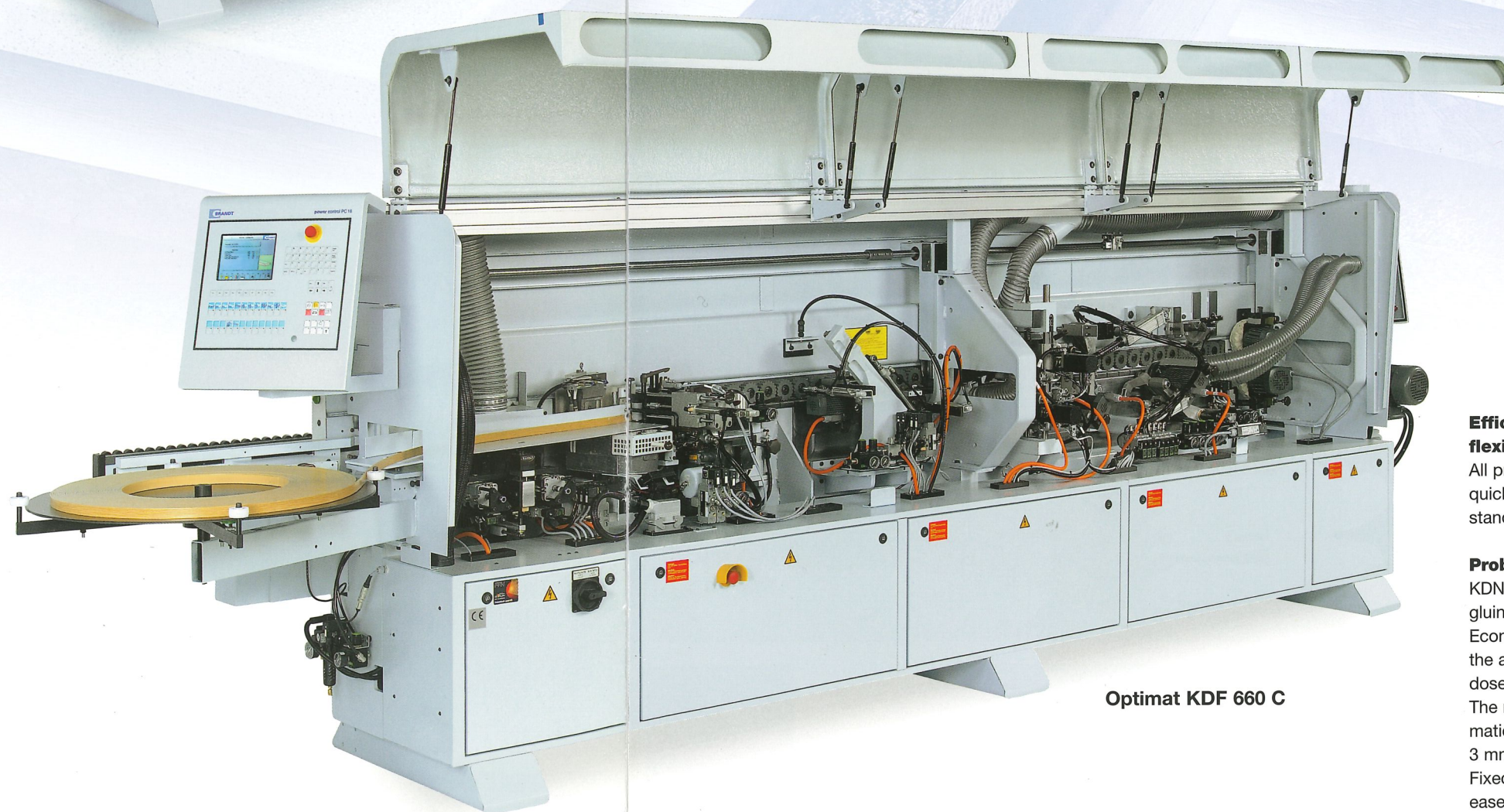

Optimat KDF 660 C



Efficient processing units for flexible production

All processing units share high precision, quick changeover and a high safety standard.

Problem-free gluing

KDN/F are equipped with a leak-proof gluing unit.

Economical granulate glue is used and the adhesive quantity can be precisely dosed.

The machines are equipped with an automatic coil magazine as standard, also for 3 mm PVC edges.

Fixed lengths can also be processed with ease.

User-friendly processing units

Efficient processing units for flexible production

All processing units share high precision quick changeover, service-friendly design and a high safety standard.

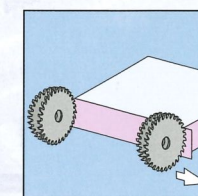
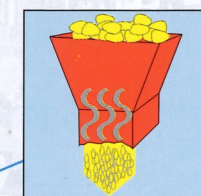
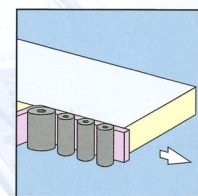
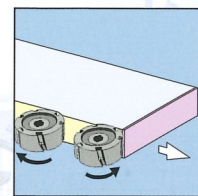
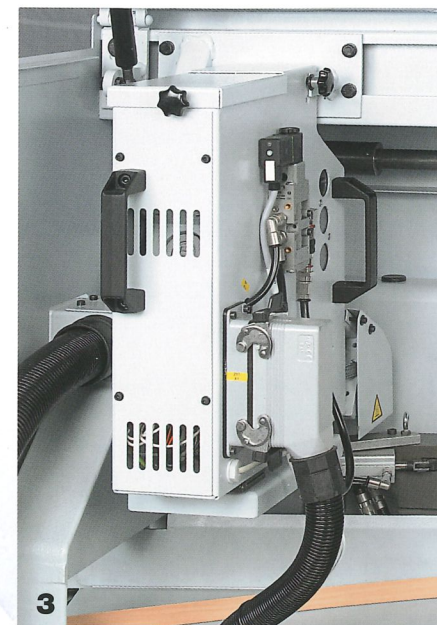
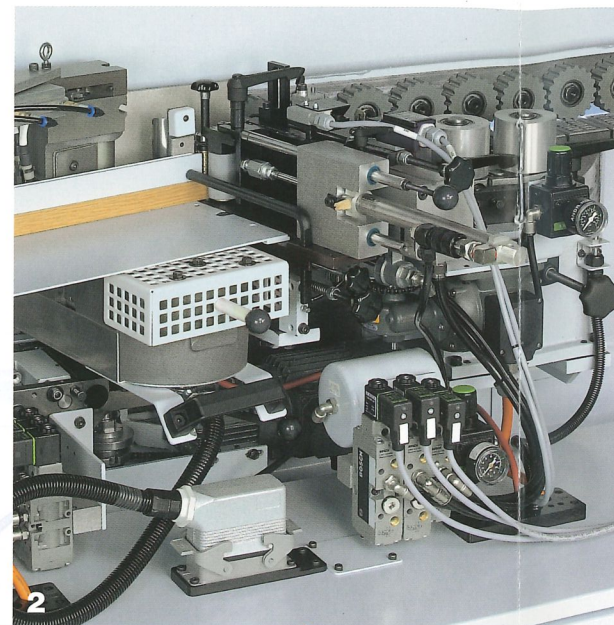
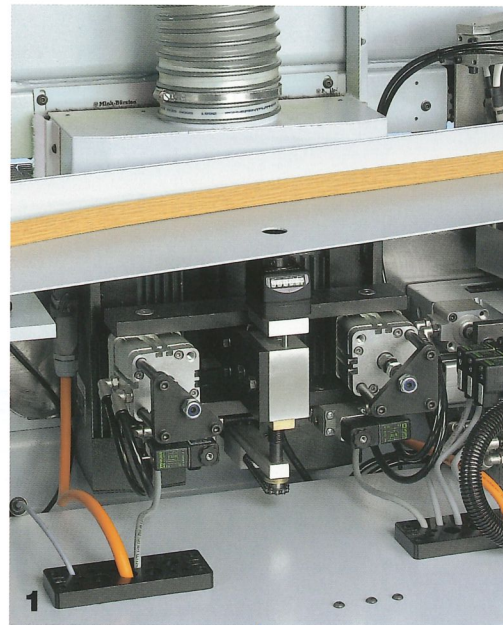

Control system Power Control PC 16

- All functions at your finger tips
- Short set-up times
- Fault diagnosis in plain text
- Graphical surface
- Production data acquisition

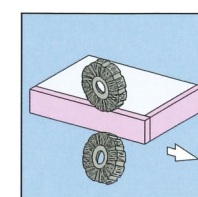
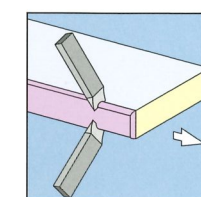
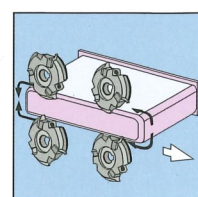
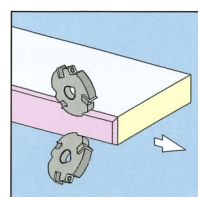
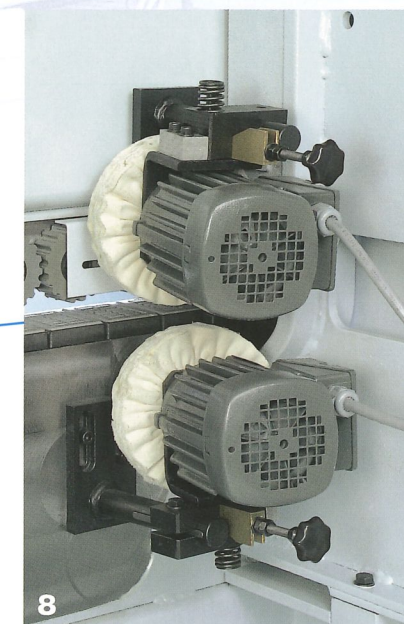
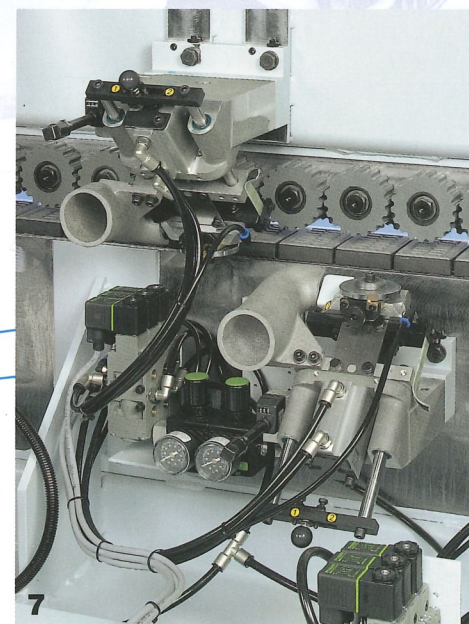
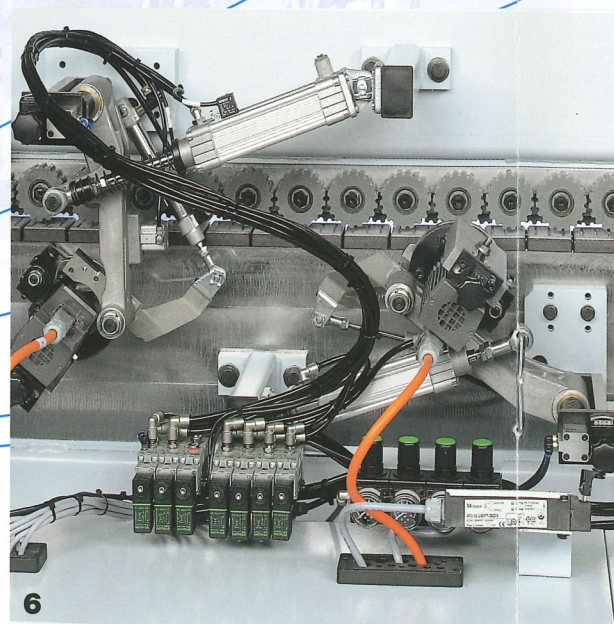
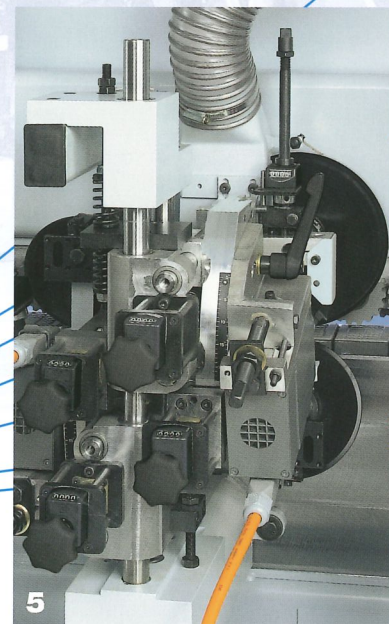
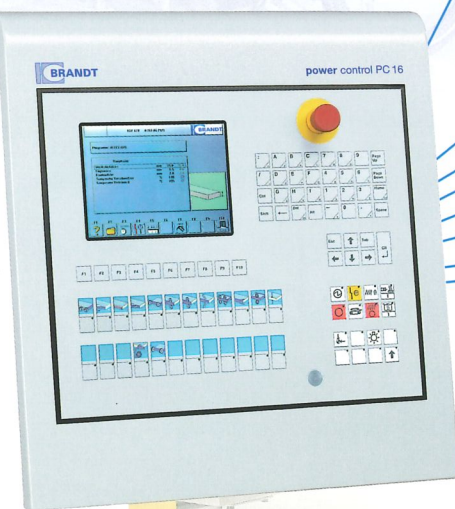

1. Joint trimming unit

Two trimming motors of 2.2 kW each, 12.000 rpm, rotating direction: synchronous / counter running. Equipped with diamond cutters as standard. This process provides optimal edge quality.

2. Standard gluing unit

Leak-proof quick-heating container (QUICKMELT as option). Infrared heating system. Automatic edge infeed for coils and strips.

3. Premelter (option)

High availability and optimum glue quality due to the Quickmelt gluing station.

4. End Trimming unit, straight/bevel

Two trimming motors of 0.35 kW each, 12.000 rpm. Drawing cut for high accuracy, high precision linear THK guides.

5. Flush trimming unit

Two trimming motors of 0.55 kW each, 12.000 rpm, swivelling from 0-25 degrees. Equipped with combination straight / radius cutters. Digital counters for all adjustment.

One or two units are included according to machine type.

6. Contour trimming unit

For corner radiusing of thick PVC edges and cover edges on post and soft formed parts. Two motors of 0.35 kW each, 12.000 rpm, equipped with radius insert cutters.

7. Profile Scraping unit

For scraping of radii or chamfers. Horizontal / vertical tracing.

Surface scraping unit (optional)

For scraping and / or cleaning of workpiece surfaces in glue joint area to remove residual hot melt. Pneumatic blow-off device for cleaning cutting edges, as well as pneumatic adjustment.

8. Buffing unit

For polishing of edges. 2 motors of 0.18 kW each (with optional Oscillation device and pneumatic insertion control).

Technical data

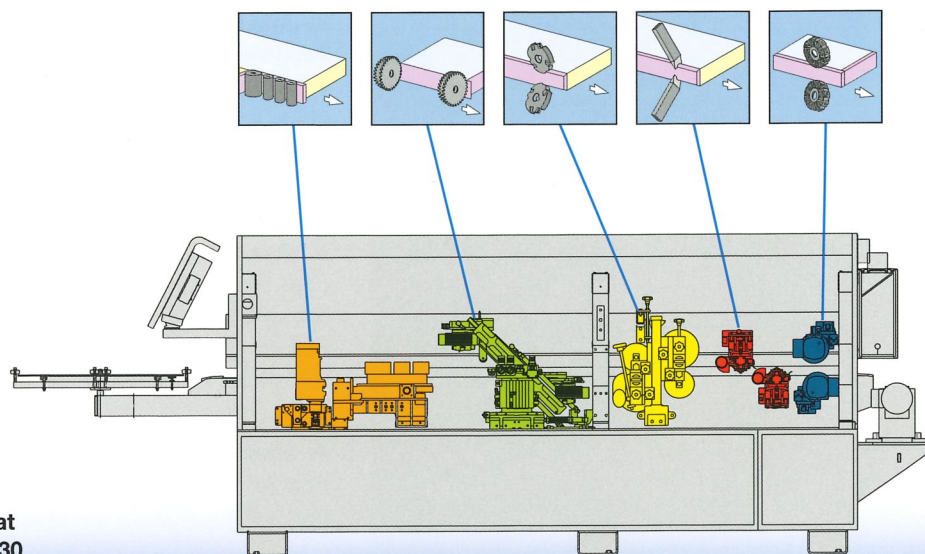

**Optimat
KDN 630**

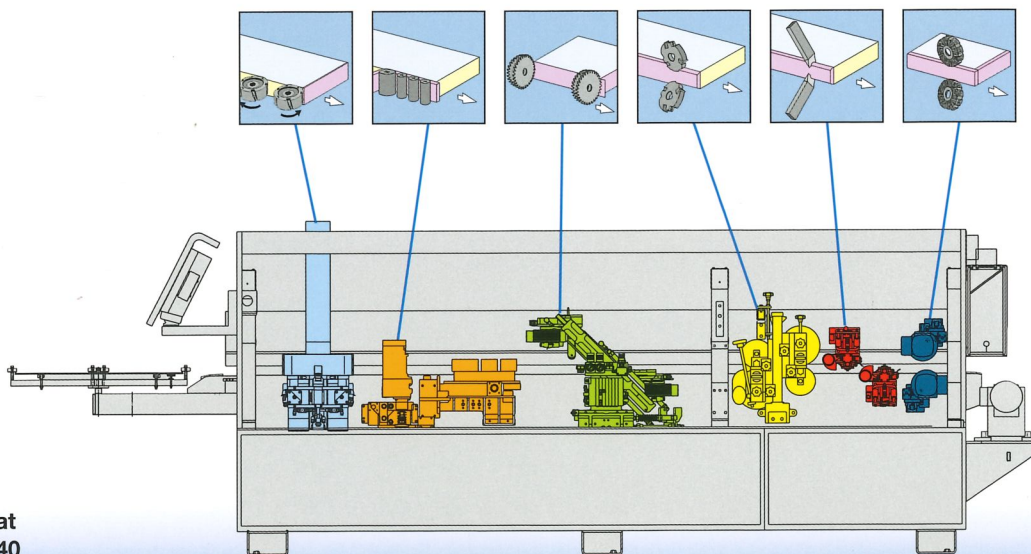

**Optimat
KDF 640**

	KDN 630	KDF 640
Machine length (mm)	4860	5360
Connected load (kW)	6	11
Weight (kg)	1650	2050
Dust outlet diameter (mm)	1x120/1x100	2x120/1x100
Feed speed (m/min)		16
Machine dimensions WxH (mm)		900 x 1600
Workpiece thickness (mm)		8 - 60
Edge thickness (mm)		0,4 - 12
Coil cut-off (mm)		3 x 45/1 x 65
Working height (mm)		950
Power		400 V - 3 Ph - 50 Hz
Air supply requirements (bar)		6
Noise emission (dBA)		84/85

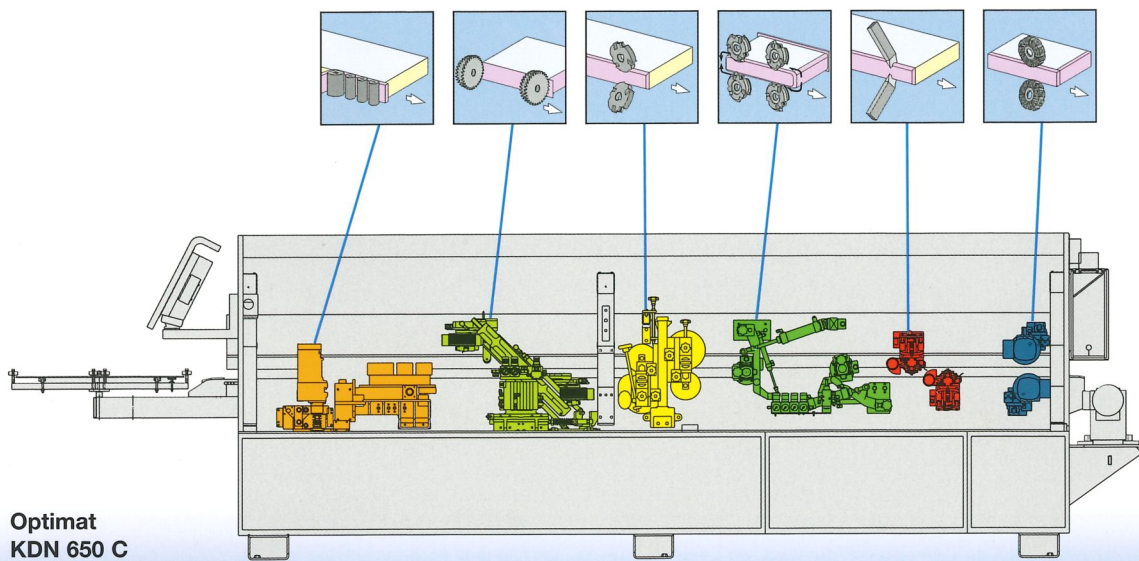

**Optimat
KDN 650 C**

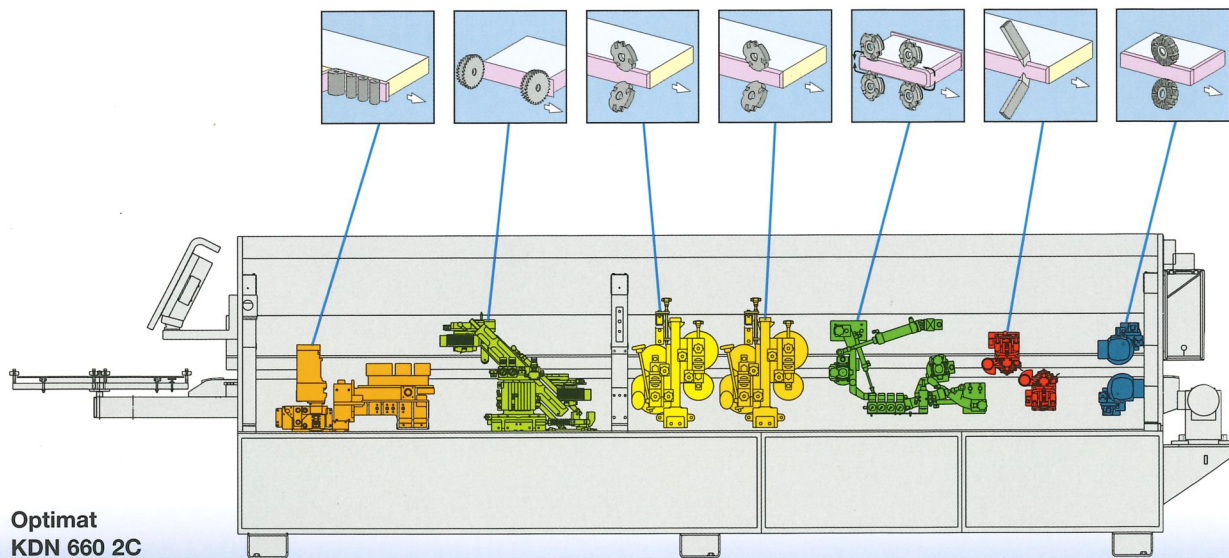

**Optimat
KDN 660 2C**

	KDN 650 C	KDN 660 2C
Machine length (mm)	5860	6360
Connected load (kW)	7	10
Weight (kg)	2200	2500
Dust outlet diameter (mm)	1x120/1x100	1x160/1x100
Feed speed (m/min)		11/16
Machine dimensions WxH (mm)		900 x 1600
Workpiece thickness (mm)		8 - 60
Edge thickness (mm)		0,4 - 12
Coil cut-off (mm)		3 x 45/1 x 65
Working height (mm)		950
Power		400 V - 3 Ph - 50 Hz
Air supply requirements (bar)		6
Noise emission (dBA)		84/85

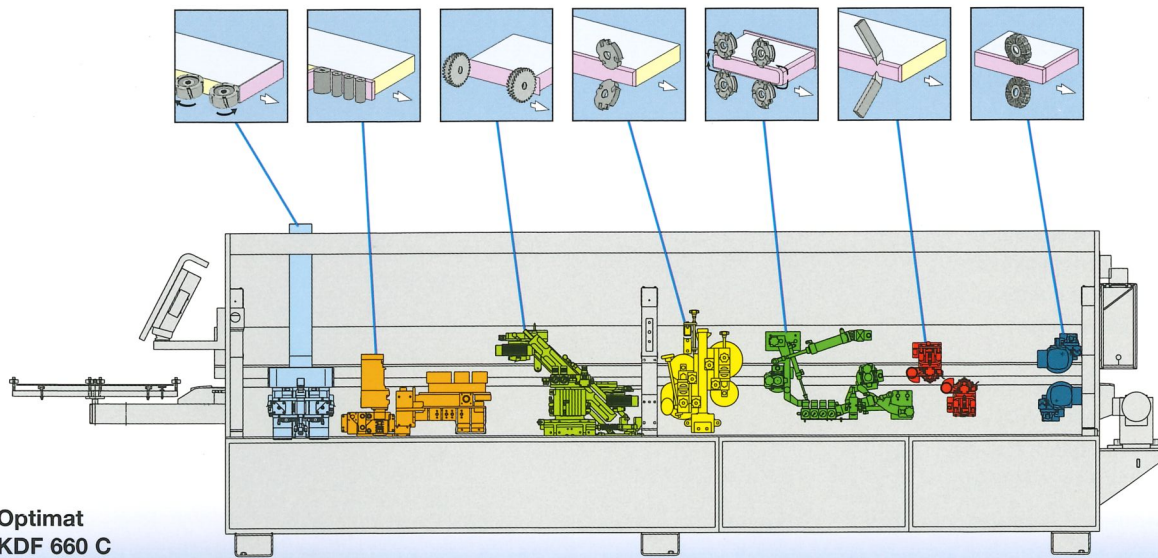

**Optimat
KDF 660 C**

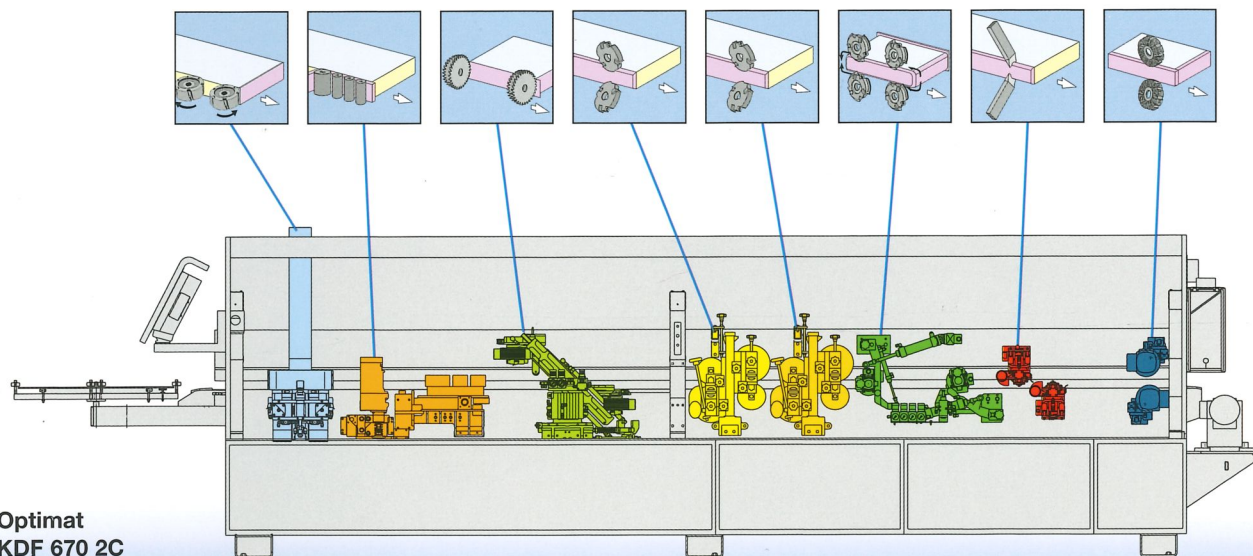

**Optimat
KDF 670 2C**

	KDF 660 C	KDF 670 2C
Machine length (mm)	6360	6860
Connected load (kW)	12	15
Weight (kg)	2600	2800
Dust outlet diameter (mm)	1x120/1x120/1x100	1x120/1x160/1x100
Feed speed (m/min)		11/16
Machine dimensions WxH (mm)		900x1600
Workpiece thickness (mm)		8 - 60
Edge thickness (mm)		0,4 - 12
Coil cut-off (mm)		3,0 x 45/1 x 65
Working height (mm)		950
Power		400 V - 3 Ph - 50 Hz
Air supply requirements (bar)		6
Noise emission (dBA)		84/85

It pays to be a Brandt Customer



Brandt is everywhere

Our extensive service, sales and support network means shorter distances for you. Brandt is never far away – no matter where you are in the world.

Expertise

Continuous training of the sales and servicing personnel of our sales partners at the Brandt training centre guarantees optimal and expert care.

Identical parts, simple handling

Many parts, control elements and component groups are common to all machines and systems of the Homag Group.

This facilitates operation and replacement part pooling, and accelerates servicing and maintenance.



HELP

COMPONENTS

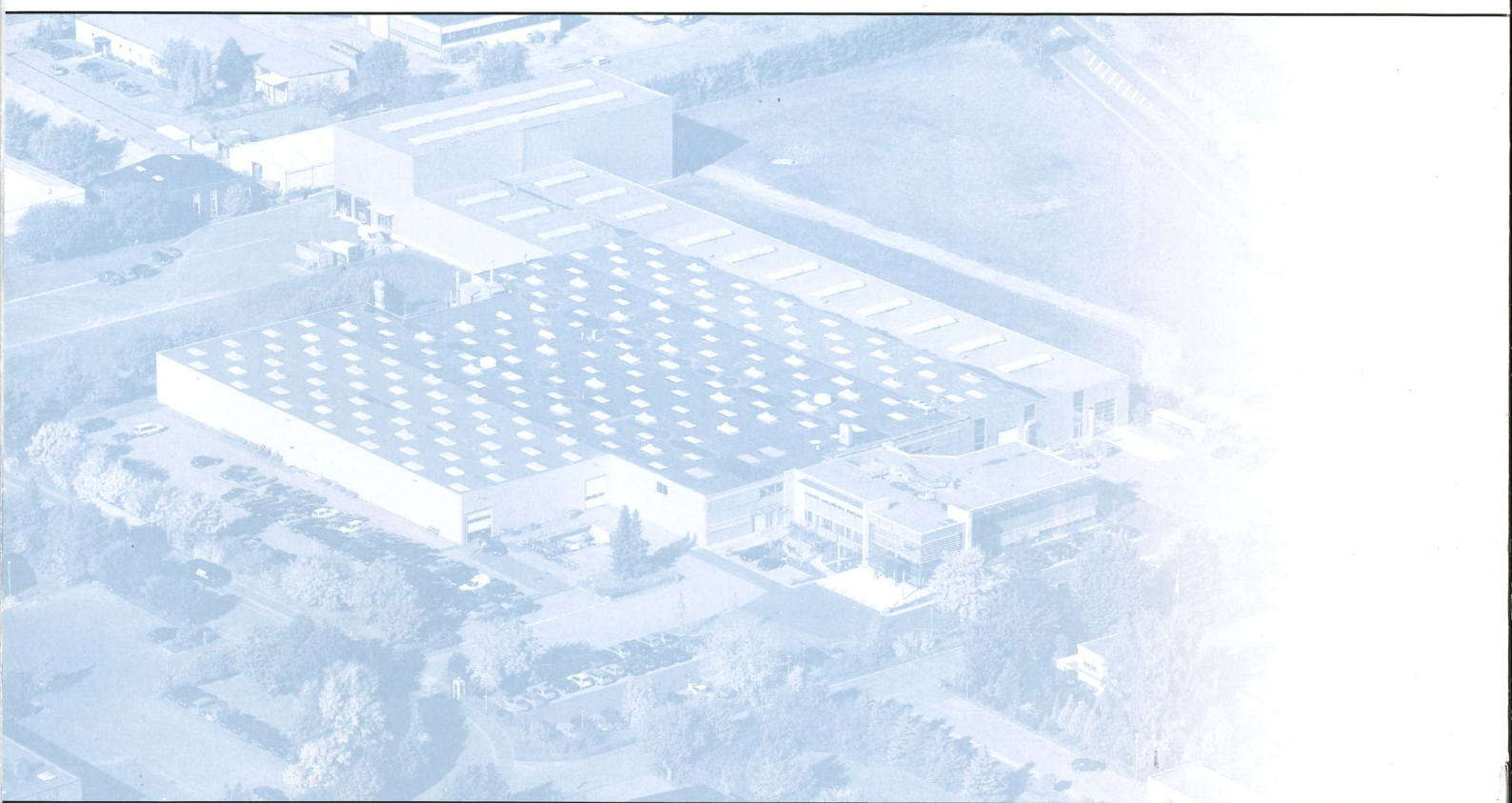

A member of the Homag Group



Brandt
Kantentechnik GmbH
Weststraße 2
D-32657 Lemgo
Tel. 05261/974-0
Fax 05261/6486
info@brandt.de
<http://www.brandt.de>

