

Designed by Nature

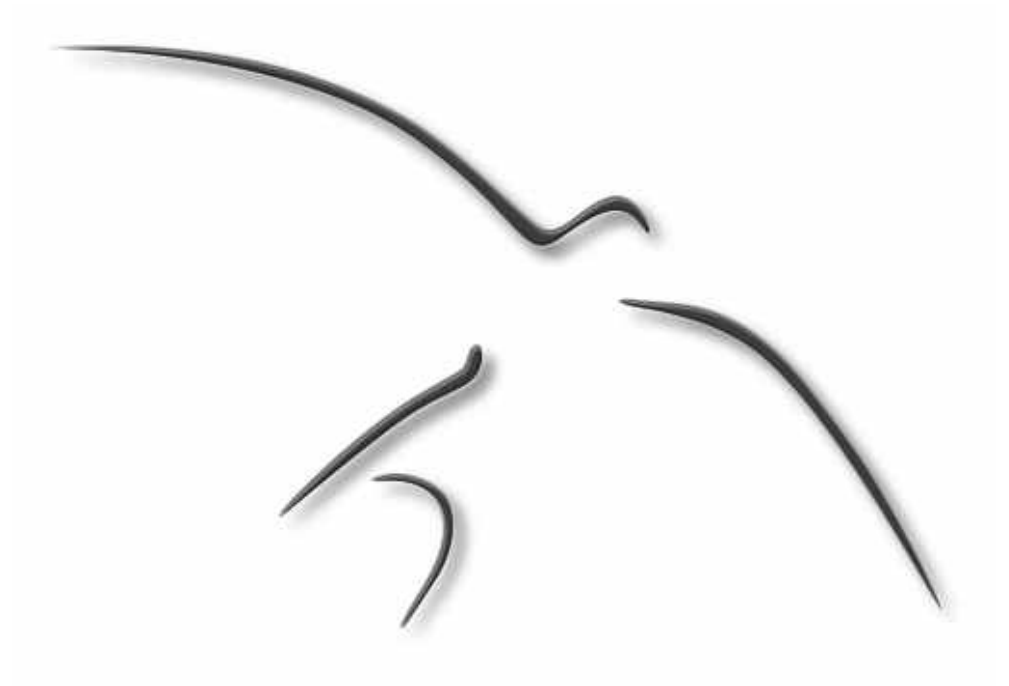

...the Hoffmann Dovetail Key
Main Catalogue



The Company Hoffmann Maschinenbau



Customer satisfaction was the first priority when Dr. Walter Hoffmann and his two sons, Thomas and Martin, established their business in 1990. They began developing and constructing machinery and equipment for the woodworking industry and other areas. This is still our philosophy today.

Shortly after founding the company, a historic event took place with far-reaching implications:

The idea that resulted in the "Hoffmann-Schwalbe" (Hoffmann Key).

It was the result of several years of development work by Thomas and Martin Hoffmann, whilst working abroad in the U.S. Designs and tests were carried out on numerous, sometimes even extreme applications. The result is a molded four dimensional key in a double dovetail shape with obliquely converging ribbed inner surfaces, which is able to draw together two work-pieces in a stable and permanent joint.

The Hoffmann Key changed the business activities of Hoffmann:

The joining of work-pieces and components of all kinds, by our customers, has become a core part of the company.

For this we offer a wide range of Hoffmann Keys and other related jointing systems with extensive processing techniques for industrial and craftwork usage.

As a company, Hoffmann is globally established and active worldwide. Operating from its headquarters in Bruchsal, Germany, sales offices are maintained in numerous foreign markets. Customer focus and satisfaction are important to us and therefore our corporate objective. Talk to us about your requirements and expectations.

The Hoffmann Key



The Hoffmann Key	4
The System	4
The Range of Hoffmann Keys	6
Applications of the Hoffmann Key	8
The Know-How is already in the system	10
Fox Floor Key	11

Hoffmann Machine Programme



Hoffmann Machine Programme	12
Dovetail Routing Machines	
> MU-Basis, X_line, eXess, MF-4	14
> PU-Basis	18
> PP-Basis	22
Double Mitre Saws	
> MS-Basis	26
Multi Axis Machining	
> MX-Basis	30
Position Control	
> ELA 2	39
> Accessories	40

Engineering Services and Customers Specific Solutions



Engineering Services and Customers Specific Solutions	34
Saw & Router Station	36
Saw & Twin Drill Automat	36
Automatic 5 Axis Routing Machine	37
Automatic Double Mitre Saw and Drilling Machine	37
Saw & Router Automated Work-Station	38
Saw / Router / Drilling Work-Station	38

Windows, Facades & Building Elements

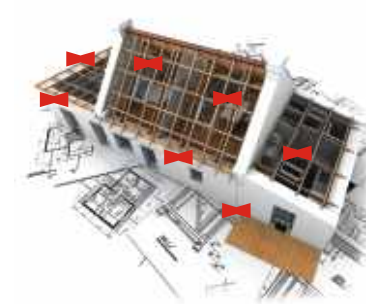

Windows, Facades & Building Elements	42
Hoffmann Keys Everywhere	42
Corner Frame Jointing	43
Post/Beam Construction Node Jointing	44
Door Manufacture	45
Skeletal Frame Construction	45

Certification & Machine Safety



Certification & Machine Safety	46
Your Safety	46
Information & Services	47

The Hoffmann Key - The System

Simply Brilliant...Brilliantly Simple

Classical characteristic

The dovetail shape is a classic feature for precision and quality, both in mechanical engineering and in the wood processing industry. This principle makes the use of the Hoffmann Key unique. Due to the extremely precise, double dovetail shape of the Key and its serrated sides, it is always a snug fit and a positive guide when driven into the routed slots. This draws the two parts to be joined, accurately and permanently together.

> **The connection can be as a but-joint, flat, compound or in any angular position**

Colour and materials

Likewise, special colours and different lengths and shapes are possible. Additionally the keys can be made of wood or in particular heat-resistant material.





Permanency in place - whether individually or in series production.

Whether in industrial use or for trade use: Hoffmann keys are generally easy to use and efficient, not only for single pieces but also in volume production. The work-pieces are held together durably, due to the two dovetail-shaped sides which have ribs on the internal sloping surfaces. Firm contact is made in the wood and therefore they grip tightly and keep the parts securely together, preventing any slide or movement of the parts. This advantage

Versatile - for every application

Hoffmann-Keys are extremely versatile in application. For each application there is an appropriate Key to fit. In general, the Keys are manufactured from high quality polymers, and are brown in colour. Other designs and colours for specific requirements are also possible on request.

Complete in a couple of seconds

Blind keyways are routed in the back of the material in the adjoining faces of the two parts. They are set together and then the Hoffmann Key is inserted - **that's it!** All related parts can be further processed immediately, as there is no need to wait until the glue dries.



The Range of Hoffmann Keys

A comprehensive range of choice

The range of size of Hoffmann Keys available, reaches from fine to large. So therefore the application also ranges from fine delicate work as in picture framing (from 8 mm width profiles) through frames and cornices/fascias, windows, doors, furniture components, to heavy post and beam construction. Accordingly there are four sizes of Hoffmann Keys, for each appropriate application, available in various lengths. This means there is a statically correct size of Key for each application.

W1



- > Frames (pictures, mirrors, Cassettes)
- > Strips (mounted)
- > Cornices
- > Georgian bars
- > Drawers

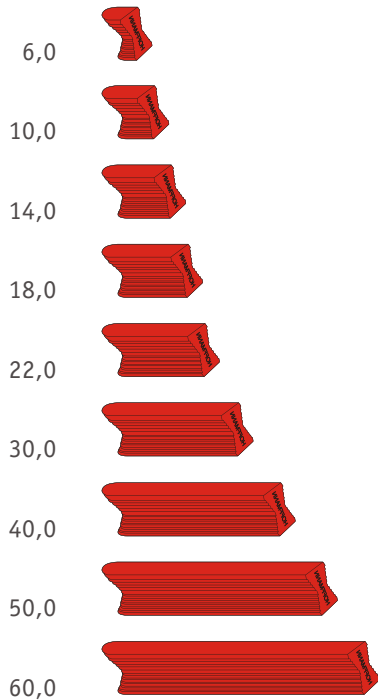

W2



- > Internal outfitting
- > Plinths and mouldings
- > Panels cladding
- > Door linings
- > Furniture
- > Frames

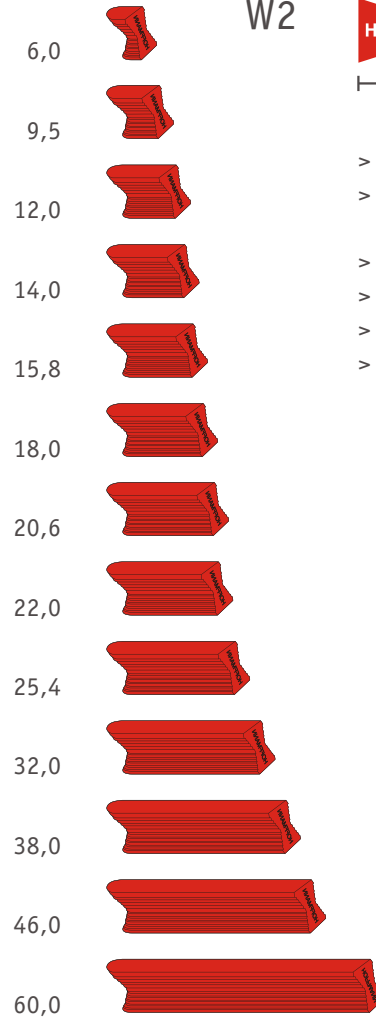

W3



- > Internal outfitting
- > Work-tops
- > Corner seats
- > Frames
- > Handrails
- > Curved / arched windows
- > Wood / aluminium windows

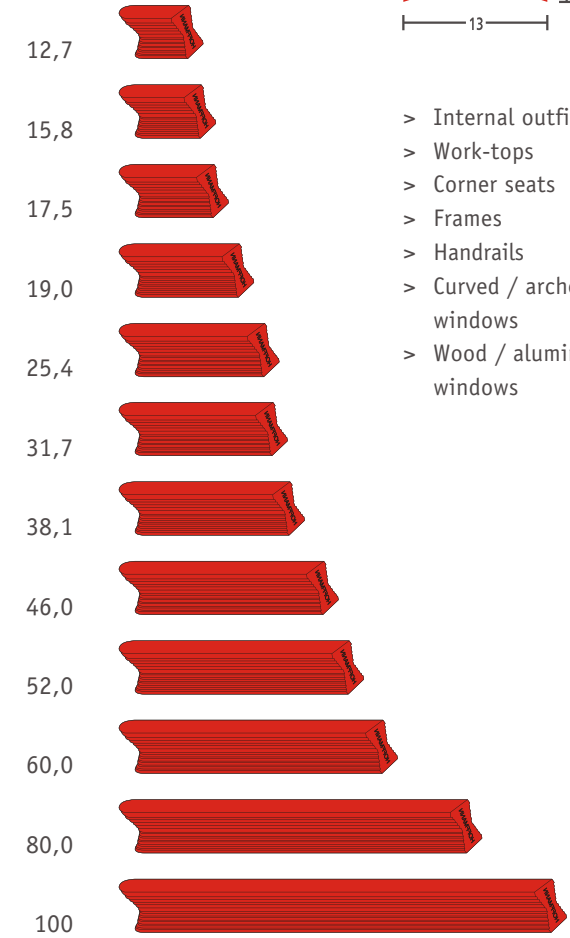

Hoffmann Keys in mm

W4



- > Post / beam construction / facades (with building approval)
- > Conservatories
- > Pergolas
- > Frame structures
- > Prefabricated houses

40,0



60,0



80,0



100



Shapes & Colours



Hoffmann-Keys are extremely versatile and are provided for every requirement in each correct size. Hoffmann Keys are manufactured from high quality polymers in a standard brown colour.

Similarly, special colors and different lengths and shapes are also possible. In addition, the Hoffmann Keys are available in wood, aluminum or particularly heat-resistant material.



FOX



The multi functional jointer for wooden decking.

A multifunctional jointing method for fast and simple assembly of wooden decking on a surface. No tools, hammers, screws, stapling or clips. The connections are invisible.

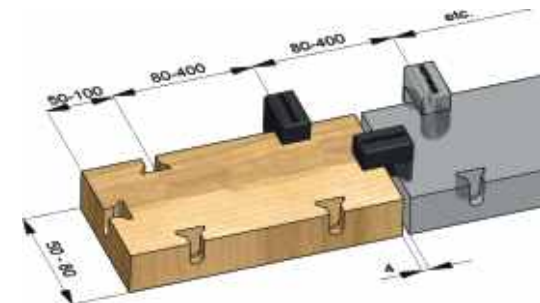

Applications of the Hoffmann Key

Join whatever you wish

The potential range of use for the Hoffmann Key in all areas of the woodworking industry is enormous. For each application select the appropriate Key. It is simply brilliant and incredibly simple.



Picture frames
from 8mm width

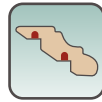

Cornices
Crown mouldings



Picture frames
Panels
Glazing frames

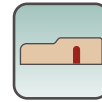

Lighting strips
Lighting screens
Mouldings and
sub-structures

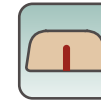

Georgian bars
Glazing cassettes
Curved frames

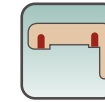

Door linings
Frames
Building frames

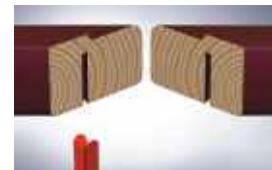



Plinths
Drawers
Boxes, shelves
Vision panels



Hand rails (profiled)
Banisters

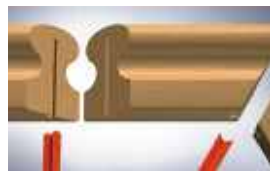

Circular handrails

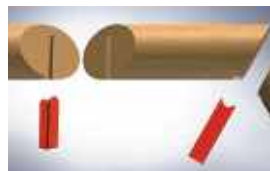

Window frames
Wood Wood / Alu
Plastic

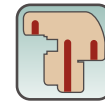

Window sash
Wood wood / Alu
Plastic

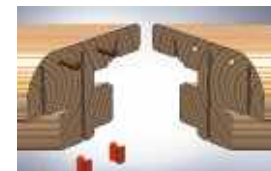

Post / beam
Glass facades
Conservatories
Pre-fab houses



The Know-How is already in the system

Knowhow

The correct tension of the Hoffmann Key

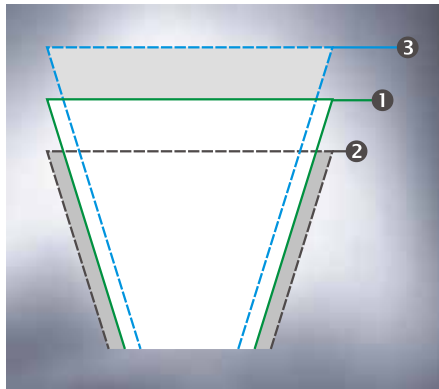

- 1 The ideal router depth setting**
The optimum router-depth-setting is factory pre-set. This would give the optimum joint strength in various different types of wood profiles.
- 2 To reduce the joint tension**
Factory setting (Setting tool) minus 0.2 mm results in a softer joint.
- 3 To increase the joint tension**
Factory setting plus 0.2 mm results in a tighter joint.

The correct router-slot length

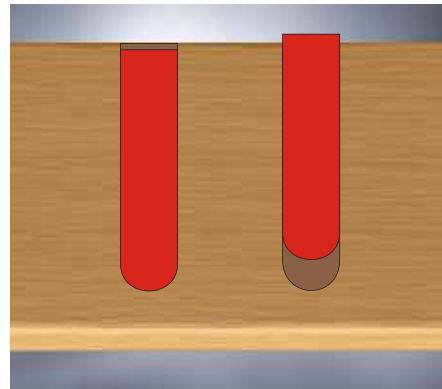

The Hoffmann Key should, ideally, always be inserted to the end of the routed slot. This results in a higher joint strength due to the gripping sides of the dovetail Key.

The router slot should always be cut close to the finish surface of the work-piece (approx 3 mm).

The statically correct length of the Hoffmann Key

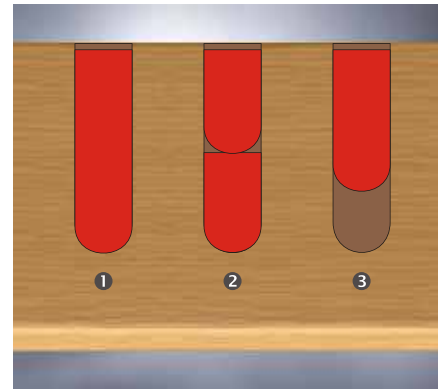

- 1** Correct choice of Key length
- 2** Optional choice of 2 Hoffmann keys
- 3** Incorrect Hoffmann Key length or incorrect router slot length

Hoffmann offers a sufficient number of different lengths of dovetail Keys for numerous joint applications. When routing long dovetail slots there is the option of inserting multiple Keys.

The ideal distance from the corner



- 1** Correct Key position
- 2** Incorrect position

Ensure adequate distance is kept from the outside corner to avoid a split in the profile.

Fox Floor Key

The multi-function jointer

Current fashions encourage designs which increasingly merge the house and garden to create the home. In both these areas it is important to start from the floor up, quite literally, so that both the interior and exterior reflect the tastes of the occupants.

The innovative multifunctional connector "FoX" by Hoffmann creates a unique design freedom, for an exquisite environment.

The FoX Key is made of natural rubber and can be used for all the traditional garden furniture wood such as black locust, Bangkirai, Massaranduba, Garapa, Douglas fir, larch and pine. As well as thermally treated beech and ash (Thermo wood) and for wood-plastic composites WPC.

FoX allows quick and easy assembly of the wooden planks on the prepared surface. It is manually inserted into the pre-routed slots on the reverse side of the timber, piece by piece until the desired size of the area to be covered is achieved. Grid patterns, either longitudinally or transversely orientated, or in a combined grid pattern can be made to customer's desired choice. They can be manufactured with or without joint-spacing and the drainage distance between the wood and the prepared surface is determined by the length of the routed Fox slot.

For routing the Fox slots (fixing grooves) in the wooden planks and to ensure a snug fit of the Fox Key, Hoffmann offers different machine options. These range from the simple hand-held machines and bench-top models to the free-standing and bespoke made machine designs.

Installation - Quick and easy

FoX is a multi-functional jointing method made of natural rubber. By simply manually pressing the FoX Key into the pre-routed slots on the underside of the timber, the floor-panels are laid, piece by piece, until the desired floor area is reached. To complete, then follows the outer edge. To do this, insert the single-sided Fox, this serves as an outer edge support. Job done.



This is really as quick as child's play, but in record time. No tools, hammers, screws, stapling or clips. A additional benefit is that the joints are invisible. Yet, another is that the length of the routed slot determines the distance to the ground (water drainage).

For cleaning and maintenance of the wooden floor, it can be dismantled at any time: Pick up pieces of wood and remove Fox connectors, clean and treat with care oil. Then reassemble, as previous.



foX
by HOFFMANN

Hoffmann Machine Programme

Brilliant and simple

As a complete service provider and comprehensive systems developer for wood joints, Hoffmann presents respective machines and technology for processing material for manufacture with Hoffmann-Keys and the FoX connectors. The machine product range extends from hand-held machines for site assembly, through standardized machines in various design formats, to bespoke machines designed to customers specific production solutions.

In the following pages we are offering you the current options. If these options do not meet your needs, please contact us to discuss your requirements, so that we can develop a detailed solution.



Designed and built in a range of sizes, with various capacities and output potential as well as available with various routing depths.
 Select your option according to your desired range of application.

Dovetail Routing Machines

MU-/PP-/PU-Basis
 From Page 14



To router the dovetail slots for Hoffmann Keys, the choice ranges from the flexible hand held machine through the manual bench-top variations to the free-standing pneumatic models.

Double Mitre Saws

MS-Basis
 From page 26



An absolute innovation is the Saw and Dovetail Routing machine in combined operation, for the production of mitred corners with joints in wooden profiles or work-pieces in aluminium or plastics.

Multi Axis Machining

MX-Basis
 From page 30



A perfect all-rounder, when it comes to rationalizing the production of corner joints. The combined, NC controlled double-mitre saw which can also drill and rout. For the manufacture of windows, post/beam construction, doors, frames and furniture components.

Customer Specified System Solutions

From page 34



Components to make constructional joints are often subject to specific machines solutions, especially when other technical or production requirements need to be considered. Our engineers have already resolved many production problems for component manufacturers.

Accessories

Routing machines and saws
 From page 40



In individual cases production can be more effective with additional machine accessories or specific processing options. Expand the capabilities of your machine with additional accessories that suit your production requirements.

When specifications such as optimization, rationalization and cost savings are essential aspects of your production, then your relevant contact personnel can be found in our "engineering services department". We can develop a coordinated package of measures that will result in a machine, designed to your requirements, including the optimization of machining processes for efficiency, quality assurance and cost minimization.

MU 2

Manual Dovetail Routing Machine



Portable and flexible bench-top machine, for routing a single dovetail slot with each machine cycle. Hoffmann Key sizes W-1/2/3/4.

Function

Position the work-piece on the centre-fence and move according to the profile width. Pull down the handle to clamp the work-piece. Continued pressure raises the router carriage to the pre-set depth. When the handle is returned, the carriage lowers to its home position and the work-piece is released. The motor switches on and off automatically.



Machine components

1. Automatic switch
2. Router motor
3. Extraction port



Operating elements

1. But-stop
2. Centre fence
3. Scale tape

Technical data

Power supply	1ph/N/PE 230 V 50/60Hz 1.0 kW
Motor	1 x 1000 W
Motor speed	34000 1/min.
Control	manual
Work-piece clamping	manual
Height capacity	125 mm
Routing depth	0-85 mm
Extraction port	Ø 60 mm
Hoffmann Key sizes	W-1/2/3/4
Dimensions W/D/H	680/600/700 mm
Weight	29 kg
Order No	W 102 1000



MU 2-P

Pneumatic Dovetail Routing Machine



Portable and flexible bench-top machine, for routing a single dovetail slot with each machine cycle.
Hoffmann Key sizes W-1/2/3/4.

Function

Position the work-piece on the centre-fence and move according to the profile width. The automatic machine cycle is actuated by pressing the foot-pedal. The work-piece is clamped and the router carriage rises to the pre-set router depth. When the routing is complete the motor travels to its home position, the motor switches automatically off and the work-piece can be removed.



Machine components

1. Return valve
2. Router motor
3. Valve for clamp operation.
4. Air-line maintenance / oiler
5. Drive cylinder
6. Limit-switch for motor
7. Extraction port



Operating elements

1. Angle fence 45°
2. But-stop
3. Routing depth adjustment
4. Work-piece clamping

Technical data

Power supply	1ph/N/PE 230 V 50/60Hz 1.0 kW
Pneumatic	6 bar
Motor	1 x 1000 W
Motor speed	34000 1/min.
Control / Work-piece clamping	Pneumatic / Pneumatic
Height capacity	150 mm
Routing depth	0-75 mm
Extraction port	Ø 60 mm
Hoffmann Key sizes	W-1/2/3/4
Dimensions W/D/H	680/600/500 mm
Weight	32 kg
Order No	W 102 2000

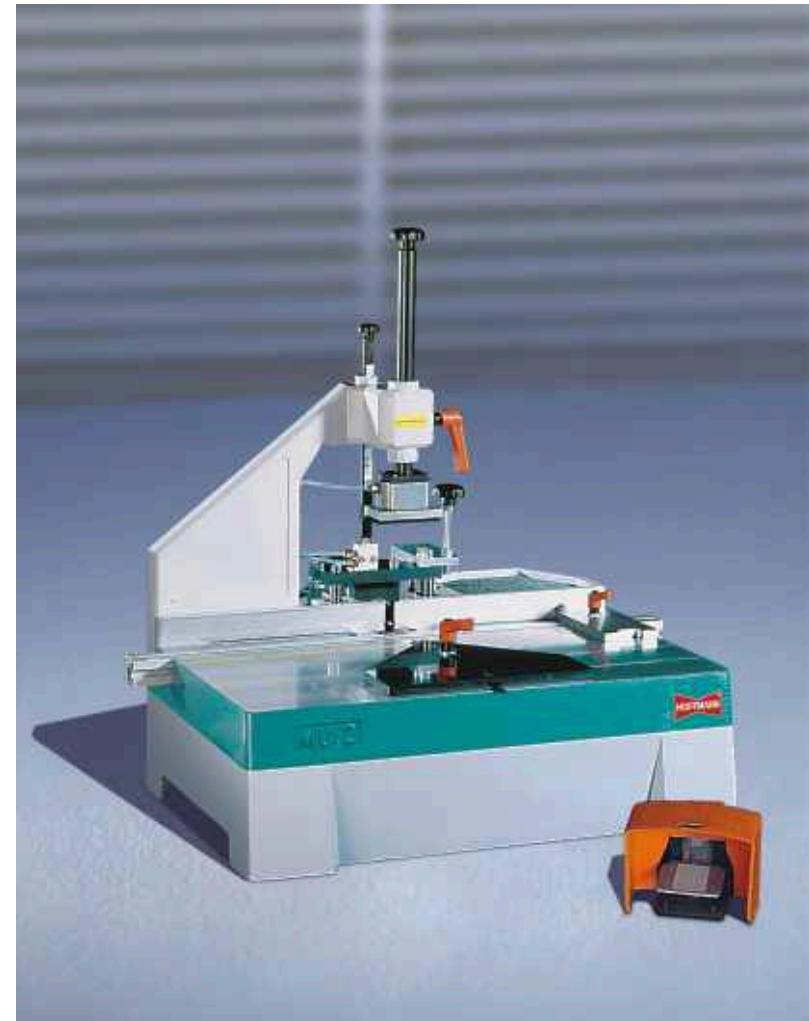

MU 2-H

Horizontal, Manual Dovetail Routing Machine



Portable and flexible bench-top machine to router a single horizontal dovetail slot per machine cycle. Dovetail key sizes W-1/2/3/4.

Function

The work-piece is positioned against the centre-fence and the routing length (left & right) is set. By pressing the pneumatic foot-pedal the work-piece is clamped. The motor is switched on manually and the motor unit is drawn to the set router length. When the part is routed the unit is brought to the middle position, motor switched off and the work-piece is removed after releasing the foot-pedal.

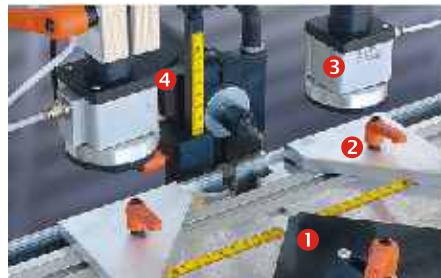

View of table

1. Fence plate 45°
2. Internal fences
3. Cylinder for work-piece clamping
4. Horizontal routing height positioning

Technical data

Power supply	1ph/N/PE 230 V 50/60Hz 1.0 kW
Pneumatic	6 bar
Motor	1 x 1000 W
Motor speed	34000 1/min.
Control	Manual
Work-piece clamping	Pneumatic
Height capacity	110 mm
Routing depth	H 0-80 / L 0-250 mm
Hoffmann Key sizes	W-1/2/3/4
Dimensions W/D/H	700/600/500 mm
Weight	33 kg
Order No	W 102 3000

X_line 20

Manual Dovetail Routing Machine



Portable and flexible bench-top machine, for routing a single dovetail slot with each machine cycle. Hoffmann Key sizes W-1/2/3/. Most of the relevant accessories can be used on this machine. Option: Twin version with a double spindle gearbox to produce two dovetail slots per machine cycle.

Function

Position the work-piece on the centre-fence and move according to the profile width. Pull down the handle to clamp the work-piece. Continued pressure raises the router carriage to the pre-set depth. When the handle is returned, the carriage lowers to its home position and the work-piece is released. The motor switches on and off automatically.



Machine components

1. Motor
2. Router depth setting
3. Micro switch for motor

Operating Elements

1. Router depth setting
2. Work-piece clamping
3. Chip-breaker

Technical data

Power supply	1ph/N/PE 230 V 50/60Hz 0.5 kW
Motor	1 x 530 W
Motor speed	29000 1/min.
Control	manual
Work-piece clamping	manual
Height capacity	110 mm
Routing depth	0-80 mm
Extraction port	Ø 60 mm
Hoffmann Key sizes	W-1/2/3
Dimensions W/D/H	600/540/770 mm
Weight	19 kg
Order No	W 100 0200

X_line 25

Pneumatic Dovetail Routing Machine



Portable and flexible bench-top machine, for routing a single dovetail slot with each machine cycle. Hoffmann Key sizes W-1/2/3. Suitable for smaller production runs. Most of the relevant accessories can be used on this machine.



Technical data

Power supply	1ph/N/PE 230 V 50/60Hz 0.5 kW
Pneumatic	6 bar
Motor	1 x 530 W
Motor speed	29000 1/min.
Control	Pneumatic
Work-piece clamping	Pneumatic
Height capacity	95 mm
Routing depth	0-75 mm
Extraction port	Ø 60 mm
Hoffmann Key sizes	W-1/2/3
Dimensions W/D/H	600/540/580 mm
Weight	20 kg
Order No	W 100 0250

eXess

Hand Routing Unit



Flexible hand routing unit to produce dovetail slots in sizes W-1/2/3 as well as W-4 (option). Entry level model without compromising quality or performance.

Function

Routing operation by choice of fixed(1) or by hand (2). 1. The hand unit is secured to the work-bench. The work-piece is positioned and held on the fence. The router unit is raised manually through the work-piece. 2. The hand unit is placed on the work-piece and secured. The router unit is then pushed down through the material.



Technical Data

Power supply	1ph/N/PE 230 V 50/60Hz 0.5 kW
Motor	1 x 530 W
Motor Speed	29000 1/min.
Operation	manual
Clamping	manual
Routing depth	0-68 mm
Extraction port	Ø 28 mm external
Hoffmann Key sizes	W-1/2/3/4 (opt.)
Dimensions W/D/H	185/330/230 mm
Weight	3,3 kg
Order No	W 101 4000

MF-4

Manual Router Unit



Portable Dovetail Routing unit for the production of dovetail slots in the size W-4. E.g. post and beam construction cross joints or similar applications. Quickly produced in the work-shop or for on-site measured pieces.

Function

The routing position is marked on the work-piece. The MF-4 unit is positioned on the work-piece and secured with screws or G-clamps. The unit then routers manually to the router depth stop. For high precision routing also in the horizontal position.



Technical Data

Power supply	1ph/N/PE 230 V 50/60Hz 1.0 kW
Motor	1 x 1000 W
Motor speed	34000 1/min.
Control	manual
Clamping	manual
	Srcrew or G-Clamp
Router depth	0-220 mm
Hoffmann Key size	W-4
Dimensions B/T/H	200/300/460 mm
Weight	5 kg
Order No.	W 101 2000

PU 2-32-100

Pneumatic Dovetail Routing Machine



Free-standing version with solid cast table and large working surface at a comfortable working height. With two routing units to produce two dovetail slots in sizes of W-1/2/3 and option W-4. Infinitely adjustable router cross-centres from 32 mm to 100 mm.

Function

The semi-automatic machine cycle is actuated by pressing the foot-pedal. The positioned work-piece is clamped and the units router to the pre-set depth and then return to their home position. The work-piece is then released. The centre-fence position and the routing depth are selected manually. The router cross-centres are positioned manually with the aid of a lead screw and digital counter.

Technical Data

Electrical power rating	1ph/N/PE 230 V 50/60Hz 2.0 kW
Pneumatic connection	6 bar
Motors	1000 W
Motor speed	34000 1/min.
Control/Work-piece clamping	pneumatic / pneumatic
Work-piece height	210 mm
Routing depth	0-115 mm
Extraction port	Ø 100 mm
Hoffmann Key sizes	W-1/2/3/4 (optional)
Dimensions W/D/H	800/750/1500 mm
Weight	220 kg
Order No.	W 107 4000



The joining of parts and components using Hoffmann Keys is attractive for all businesses whether small medium or large. The efficiency and equally the accuracy when joining components has both technical and economic benefits to business. Depending on whether single parts or series production, the ideal equipment can be selected from the Hoffmann range of machinery. Machines, optimized for their specific application and function, with clear design characteristics.

Router gearbox



The two gearboxes are design with spindle speeds of 35,000 rpm. Therefore routing dovetail slots in all wood related materials is possible.

Router depth set-up / adjustment



Both units are adjusted to the required spacing of dovetail keys, by winding the lead-screw handle and reading the digital counter.

Adjustable chip-breaker

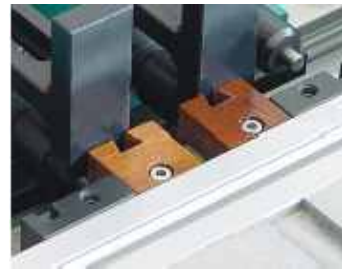

The chip-breakers are adjusted with the units to ensure clean edges to the dovetail slots even with difficult species, and with each adjustment.

Dovetail configuration



Two key slots per machine cycle with a spacing of 32 to 100 mm, ensure even with wide work-pieces an optimum strength and perfect fit of the mitre. One set-up for both pieces.

Work-piece geometry



The maximum height of work-piece to be processed is 210 mm which makes it an extremely flexible, versatile PU-2-32/100 machine. Routing depths up to 115 mm provide a wide range of possible applications.

With exceptional work-piece configurations, or difficult to machine materials, Hoffmann offer an adaptation to each machine to suit the task. Materials other than wood-based materials can also be processed, composite materials such as WPC, and many plastics are possible. We can also select the solution for your particular application, from the respective optimal tools. Carbide and diamond cutters, special shapes and special cutting geometry of the tools, can be configured to suit your requirements.

PU 2-VH / PU 2-H

Pneumatic Dovetail Routing Machine



Designed specifically for processing components for post/beam construction. Free-standing version with solid cast table, raised fences, large work surface and comfortable working height. Single routing unit to produce one dovetail slot per machine cycle, vertical or horizontal. For Hoffmann Keys W.1/2/3/4. SPS control and digital adjustment of the height position of the router. **The version PU2-H routing solely in the horizontal position.**

Function

The automatic machine cycle is started by pressing the foot-pedal. The positioned work-piece is clamped and then routed vertically or horizontally to the pre-set depth. The unit returns to its home position and the work-piece is released. The motor switches on and off automatically. Adjustment of the fences and router depths is made manually. Selection switch for horizontal or vertical routing.



- Unit
1. Advance cylinder
 2. Router motor
 3. Tooling

Technical Data

Electrical	1ph/N/PE 230 V 50/60Hz 1.7 kW
Pneumatic	6 bar
Motor	1 x 1700 W
Motor speed	25000 1/min.
Control	SPS
Clamping	pneumatic
Work-piece height	250 mm
Routing depth v/h	180 mm / 250 mm
Extraction port	Ø 100 mm
Hoffmann Key sizes	W-1/2/3/4
Dimensions W/B/H	1000/750/1600 mm
Weight	265 kg
Order No.	W 107 6000

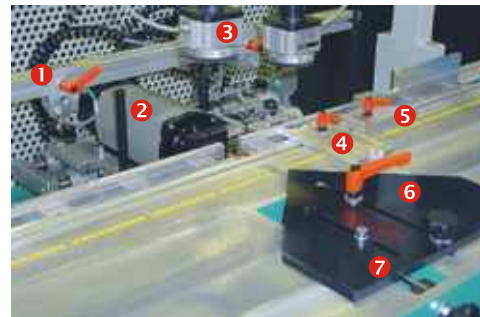

- Table view
- | | |
|----------------------------|----------------------|
| 1. Router depth horizontal | 4. But-stop |
| 2. Router motor | 5. Internal fence |
| 3. Clamping element | 6. Centre fence 45° |
| | 7. Fence positioning |



PU 2-32 / PU 2-65

Pneumatic Dovetail Routing Machine



Free-standing version with solid cast table and large working surface at a comfortable working height. With a single station comprising of twin spindle routers at a fixed spacing. Choice of 32mm or 65mm cross centres (options of alternative cross-centres). Routing two dovetail slots with each machine cycle Hoffmann Key sizes W-1/2/3. Option W-4.

Function

The automatic machine cycle is started by pressing the foot-pedal. The positioned work-piece is clamped and the routed vertically to the pre-set depth. The unit returns to its home position and the work-piece is released. The motor switches on and off automatically. Adjustment of the fences and router depths is made manually.



Router units with spindle spacing 65 mm

Technical Data

Machine	PU 2-32	PU 2-65
Electrical	1ph/N/PE 230 V 50/60Hz 1.0 kW	1ph/N/PE 230 V 50/60Hz 1.1 kW
Pneumatic	6 bar	6 bar
Motors	1000 W	530 W
Motor speed	34000 1/min.	29000 1/min.
Control / Clamping	pneumatic	pneumatic
Work-piece height	150 mm	150 mm
Router depth	0-115 mm	0-115 mm
Extraction port	Ø 100 mm	Ø 100 mm
Hoffmann Key sizes	W-1/2/3	W-1/2/3
DimensionsW/D/H	820/700/1500 mm	820/700/1500 mm
Weight	130 kg	130 kg
Order No.	W 107 3000	W 107 2000

PU 2

Pneumatic Dovetail Routing Machine



Free-standing version with solid cast table and large working surface at a comfortable working height. With a single router unit which routs a single dovetail slot with each machine cycle for Hoffmann Keysizes W-1/2/3/4.

Function

The automatic machine cycle is started by pressing the foot-pedal. The positioned work-piece is clamped and the routed vertically to the pre-set depth. The unit returns to its home position and the work-piece is released. The motor switches on and off automatically. Adjustment of the fences and router depths is made manually.

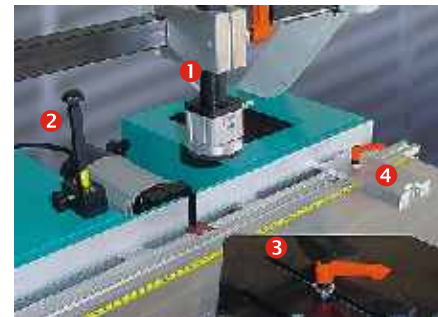

- Table view
1. Work-piece clamping
 2. Router depth setting
 3. Centre fence plate 45°
 4. But-stop

Technical Data

Electrical	1ph/N/PE 230 V 50/60Hz 1.0 kW
Pneumatic	6 bar
Motor	1 x 1000 W
Motor speed	34000 1/min.
Control	pneumatic
Clamping	pneumatic
Work-piece height	150 mm
Router depth	0-115 mm
Extraction port	Ø 100 mm
Hoffmann Key sizes	W-1/2/3/4
DimensionsW/D/H	800/750/1500 mm
Weight	119 kg
Order No.	W 107 0000

PP 2-NC

Automatic Dovetail Routing and Dowel Boring Machine



NC based machine for preparing the frame and corner joints in building components. E.g. in window and door production. This machine routes the dovetail slots (Hoffmann Keys W-1/2/3) and drills the dowel holes from 8mm. Variable positions of the slots and dowel holes horizontally, vertically or in a combination of both. Moreover the free positioning over the entire work-piece is possible. Typical example choice would be 2 x dowel holes and 3 dovetail slots. Working capacity over the mitre cut face X direction 210 mm and Z direction 140 mm.

Function

Enter all the component data and processing parameters directly on the 5.7" colour touch screen panel. Transfer of data via a USB connection is also available. Programmes can be saved and quickly called up, with 100 programme spaces of routing and boring available. Multi lingual menu/operator guidance. Simultaneous processing of two work-pieces per machine cycle. Corner joint with a choice of angle from 0° to 67° or but joints at 90°. For node connections they are butted and locked.

Technical Data

Electrical Connection	3ph/N/230/400 V 50/60 Hz 4.0 kW
Router and drilling motors	4 x 1.0 kW
Spindle drives	5.6 Nm
Display	Powerpanel/5.7" Touch-Colour display USB-Connection for data transfer/ Intuitive Operator guidance
Tooling Routing and drilling	Collet holder
Mitre cut capacity	X 0 - 210 mm / Z 0 - 140 mm
Drilling depth	0 mm - 30 mm
Hoffman Key sizes	W-1/2/3
Dimensions W/D/H	1200/1300/1500 mm
Order No.	W 108 7010



In the wood working industry the mitred corner has always been recognized as a sign of high value and quality, especially in window and door manufacture. Mitres in frame and sash joints applied in plastic, metal and wooden windows in particular, are seen as safe and reliable corner connections. More widely, the joints in mitres with Hoffmann-Keys are generally used for corner joints for windows, doors, frames, frame parts such as glazing beads and cladding as well as node connections for post/beam construction and glass façade elements. This is because on the one hand the reliability, durability and stability of this connection, and on the other hand, because of the ease and speed of production method in manufacture.

Programming

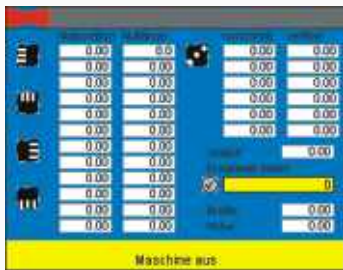

- > Software produced according to customer requirements
- > Functions optimized for quick entries
- > USB connection for external data transfer
- > Windows/Excel entry tool
- > Multi lingual
- > Updates always available
- > Barcode reader (optional)

Unit



- > Compact, optimised functions routing and drilling
- > Stable cast table with large working surface and comfortable working height
- > Ergonomic working area
- > Functional safety guard

Operator comfort



- > Touch screen colour monitor
- > Intuitive machine operation 5.7" display
- > Clear understandable sequence of the operating functions
- > Diagnostic display of the sensors and valves if malfunction occurs
- > Network connection available (optional)

Positioning



- > High acceleration and positioning speeds max. 100 mm/sec
- > Precise positioning with high quality lead screws and sensors

Flexibility

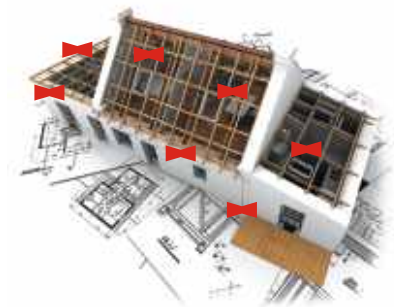

- > Versatile Applications:
 - windows
 - post/beam designs
 - furniture
 - glass facades

The services offered by Hoffmann, provide the required conform design and configuration of the connection itself and the complementary equipment and processing technology to do so. The focus of the manufacturing processes are particularly in the operational areas of sawing, routing, and dowel boring.

PP 2-32/100-4

Pneumatic Dovetail Routing Machine



Free-standing version with solid cast table and large working surface at a comfortable working height. With four router units which router two work-pieces on each machine cycle, each with two dovetail slots, for Hoffmann Key sizes W-1/2/3/4. Finely adjustable router spindle centres from 32 mm to 100 mm. When routing cornice profiles the inner and outer sets of routers can be set at different routing heights.

Function

The automatic machine cycle is actuated by pressing the foot-pedal. The positioned work-piece is clamped and the units rout to the pre-set depth and then return to their home position. The work-piece is then released. The centre-fence and the routing depth are selected manually. The router cross-centres are positioned manually with the aid of a lead screw and digital counter.

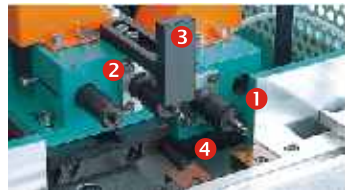

Router positioning

1. External router
2. Internal router
3. Positioning pin
4. Chip-breaker

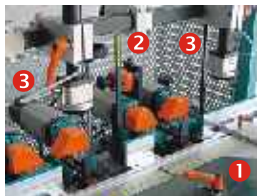

Table view

1. Centre fence 45°

Routing depth setting

2. Internal
3. External



Technical Data

Electric power	3ph/N/PE 230/400 V 50/60Hz 4.0 kW
Pneumatic	6 bar
Motors	4 x 1000 W
Motor speed	34000 1/min.
Control	pneumatic
Clamping	pneumatic
Work-piece height	150 mm
Router depth	0-115 mm
Extraction port	Ø 100 mm
Hoffmann Key sizes	W-1/2/3
Dimensions W/D/H	1000/750/1500 mm
Weight	240 kg
Order No.	W 108 5000

PP 2-32/100

Pneumatic Dovetail Routing Machine



Free-standing version with solid cast table and large working surface at a comfortable working height. With four router units which router two work-piece on each machine cycle, each with two dovetail slots, for Hoffmann Key sizes W-1/2/3/4. Finely adjustable router spindle centres from 32 mm to 100 mm.

Function

The automatic machine cycle is actuated by pressing the foot-pedal. The positioned work-piece is clamped and the units rout to the pre-set depth and then return to their home position. The work-piece is then released. The centre-fence and the routing depth are selected manually. The router cross-centres are positioned manually with the aid of a lead screw and digital counter.



Router Units

1. Centre fence 45°
2. Router depth setting
3. Extraction manifold

Technical Data

Electric power	3ph/N/PE 230/400 V 50/60Hz 4.0 kW
Pneumatic	6 bar
Motors	1000 W
Motor speed	34000 1/min.
Control	pneumatic
Clamping	pneumatic
Work-piece height	210 mm
Router depth	0-115 mm
Extraction port	Ø 100 mm
Hoffmann Key sizes	W-1/2/3
Dimensions W/D/H	1000/750/1500 mm
Weight	215 kg
Order No.	W 108 3000

PP 2-32 / PP 2-65

Pneumatic Dovetail Routing Machine



Free-standing version with solid cast table and large working surface at a comfortable working height. With two stations comprising of twin spindle routers at a fixed spacing. Choice of 32 mm or 65 mm cross centres, options of alternative cross-centres. Routing two dovetail slots in each work-piece with each machine cycle Hoffmann Key sizes W-1/2/3. Option W-4. Other spindle spacing available.



Technical Data

Machine	PP 2-32	PP 2-65
Electrical	3ph/N/PE 230/400 V	1ph/N/PE 230 V
	50/60Hz 4.0 kW	50/60Hz 2.2 kW
Pneumatic	6 bar	6 bar
Motors	1000 W	530 W
Motor speed	34000 1/min.	29000 1/min.
Control / Clamping	pneumatic	pneumatic
Work-piece height	150 mm	150 mm
Router depth	0-115 mm	0-115 mm
Extraction port	Ø 100 mm	Ø 100 mm
Hoffmann Key sizes	W-1/2/3 (4 optional)	W-1/2/3 (4 optional)
Dimensions W/D/H	1000/750/1500 mm	1000/750/1500 mm
Weight	235 kg	160 kg
Order No.	W 108 2000	W 108 1000

PP 2

Pneumatic Dovetail Routing Machine



Free-standing version with solid cast table and large working surface at a comfortable working height. With two stations comprising of a single router. Routing two dovetail slots (one in each work-piece) with each machine cycle Hoffmann Key sizes W-1/2/3 Option W-4 .

Function

The automatic machine cycle is actuated by pressing the foot-pedal. The positioned work-piece is clamped and the units router to the pre-set depth and then return to their home position. The work-piece is then released.



Technical Data

Electrical	1ph/N/PE 230 V
	50/60Hz 2.0 kW
Pneumatic	6 bar
Motor	2 x 1000 W
Motor speed	34000 1/min.
Control	pneumatic
Clamping	pneumatic
Work-piece height	150 mm
Router depth	0-115 mm
Extraction port	Ø 100 mm
Hoffmann Key sizes	W-1/2/3 (4 opt.)
Dimensions W/D/H	1000/750/1500 mm
Weight	158 kg
Order No.	W 108 0000

PP 2 - VARIATIONS

Pneumatic Dovetail Routing Machine

PP 2-VH / PP 2-H

Designed specifically for processing components for post/beam construction. Free-standing version with solid cast table, raised fences, large work surface and comfortable working height. Routing units for one dovetail slot in each work-piece per machine cycle. The version PP2-H routing solely in the horizontal position.



PP 2-FR

Designed specifically for window production with mitred corners and when jointing using Hoffmann Keys and dowels. Free-standing version with solid cast table at a comfortable working height. 2 x 3 router units for 3 dovetail slots and 2 x 2 drills for two dowels in each work-piece.



PP 2-H-DB

Designed specifically for window production with mitred corners and when jointing using Hoffmann Keys and dowels. Free-standing version with solid cast table at a comfortable working height. One router unit for 1 x horizontal dovetail slot, two multi drill head units.



MS 35-SF

Saw and Routing Machine



Two clean precision mitre cuts to an exact length in one machine cycle. When both pieces are to be joined together or in a frame, then they can be prepared with one or two dovetail slots in precise positions in the cut faces for jointing with Hoffmann Keys. Suitable for work-piece sizes maximum 90 x 90 mm. Hoffmann Key sizes W-1/2/3. Ideal for cutting profiles for glazing beads, cornices, plinths etc. in wood, aluminium or plastic at 45°. It can also be used solely as a Double Mitre Saw, to cut to length profiles such as glazing beads, cornices plinths etc. in wood, aluminium, and plastic. At 45° angles.

Function

- > The work-piece is laid on the table and positioned for cutting.
- > The start button is pressed to begin the machine cycle and the profile is clamped.
- > Both saw units cycle from above to make the mitre cuts.
- > The parts remain clamped whilst the tables open to allow the router units to rout one or two dovetail slots.
- > The machine tables close and the finished work-piece is removed.
- > The profile is fed through the machine till the cut face is against the digitally positioned fence stop. The next machine cycle begins.

The measurement of the profile length is determined by manual positioning of the fence stop and reading the digital display. The sequence of the router units follows automatically.

Technical Data

Electrical supply	3ph/N/PE 230/400 V 50/60Hz 5.4 kW
Pneumatic	6 bar
Saw motor	2 x 2.2 kW / spindle 30 mm
Router motor	2 x 0.5 kW / Collet 6 mm
Motor speed	Saw motor 3000 1/min. Router motor 24000 1/min
Control	SPS
Clamping	pneumatic

Material size	B 90 mm x H 90 mm
T/C tipped saw blade	Ø 350 mm x 30 mm
Router depth	0-70 mm
Extraction ports	2 x Ø 120 mm
Hoffmann Key sizes	W-1/2/3
Dimensions W/D/H	1470/950/1620 mm
Weight	680 kg
Order No	M 107 0000



In the woodwork industry a good mitre joint is recognized as a quality characteristic.

Further special improvements were made to the Double Miter Combination machine MS 35-SF. The Hoffmann design team developed technology which reduced the vibrations created on the saw blades. This resulted in an increase in the precision and accuracy of both mitre cuts so that no further work was required prior to joining. This uncompromising accuracy is particularly important when the finished surface joint is visible.

This high quality cut as well as high quality routing is achieved by almost vibration-free running of the machine, the body of which is extremely robust and weighs about 700 kg. A chip-breaker provides a chip-free cut. Another feature is the extremely low noise level which is immediately noticeable.



Option
Sawing /
Drilling



Double mitre saw

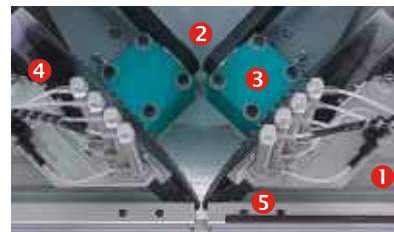

1. Aluminium tables
2. Drive belts
3. Saw spindle and bearing
4. Extraction channel
5. Chip-breaker



High precision
cut and safe
working

Machine details

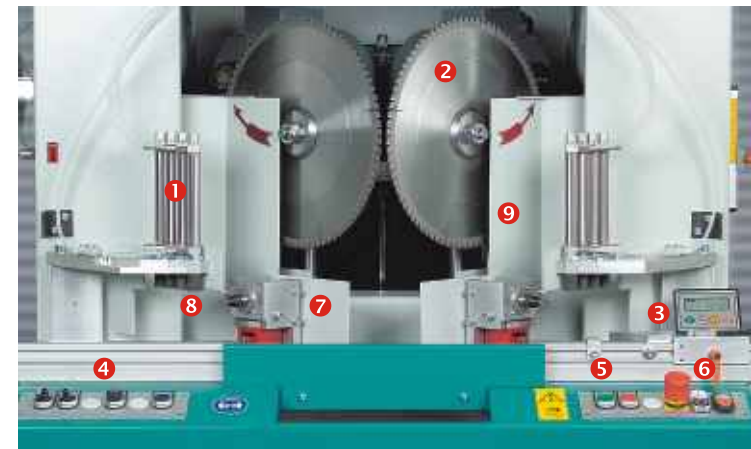

- | | |
|---|---|
| <ol style="list-style-type: none"> 1. Clamping cylinder
Individually isolated (8 pcs)
With rubber pads 2. T/C tipped saw blades 3. Length stop
Digital measurement system 4. Operating area | <ol style="list-style-type: none"> 5. Start button 6. Emergency stop button 7. High speed angle motors 8. Router tooling 9. Extraction channel |
|---|---|

Mitred joints - this quality characteristic is required on many occasions. Picture frames, furniture fronts, cassette frames, Georgian bars, door cladding and frames, windows, wooden toys and saunas. It comes down to not only stability and equally precision, but also a reliable permanent corner connection. Precise mitre cuts with the MS 35-SF are the first prerequisite for this. The ideal system for joining the parts is the Hoffmann Key. It works easily, quickly and is absolutely reliable.

MS 35

Double Mitre Saw



Precision mitre cuts without break-out. For work-pieces with a maximum cross-section of 90 x 90 mm. Clear selected, simple controls for uncomplicated and safe working. Ideal for cutting to exact length, profiles for glazing beads, cornices, plinths etc. in wood, aluminium or plastic at 45°. All dimensions for the length stop are electronically displayed. Saw unit fixed at 45°. The technology, developed by Hoffmann for damping vibrations of the blades ensures the high precision cut of the MS 35.

Function

- > The work-piece is laid on the table and positioned for cutting.
- > The start button is pressed to begin the machine cycle and the profile is clamped.
- > Both saw units cycle from above to make the mitre cuts.
- > The clamps release the work-piece which is then removed.
- > The profile is fed through the machine till the cut face is against the digitally positioned fence stop.
- > The next machine cycle begins.

Technical Data

Electrical power	3ph/N/PE 230/400 V 50/60Hz 4.4 kW
Pneumatic	6 bar
Motor	Saw motor 2 x 2.2 kW Spindle 30 mm
Motor speed	3000 1/min.
Control	pneumatisch
Clamping	pneumatisch
Max material size	B 90 mm x H 90 mm
Tooling T/C saw blades	Ø 350 mm x 30 mm
Extraction	2 x Ø 120 mm
Dimensions W/D/H	1470/950/1620 mm
Weight	620 kg
Order No.	M 105 0000



1. Digital length measuring system
2. Table fence
3. Mitre stop
4. Start/stop-button operation indicator



MS 35-F

Double Mitre Saw



Specifically designed for processing window profiles. Precision mitre cuts without break-out. For work-pieces with a maximum cross-section of 90 x 90 mm. Clear selected, simple controls for uncomplicated and safe working.

Option:

1. Fence system for long window profiles up to 4000 mm.
2. Special support for aluminium profiles.

Additional features and functions as per MS 35 description (p.28).



Length stop



Technical Data

Electrical power	3ph/N/PE 230/400 V 50/60Hz 4.4 kW
Pneumatic	6 bar
Motor	Saw motor 2 x 2.2 kW Spindle 30 mm
Motor speed	3000 1/min.
Control	pneumatisch
Clamping	pneumatisch
Max Material size	B 90 mm x H 90 mm
Tooling T/C saw blades	Ø 350 mm x 30 mm
Extraction	2 x Ø 120 mm
Dimensions W/D/H	1470/950/1620 mm
Weight	620 kg
Order No.	M 105 0000 F

Attraction and Machine Safety

Safe Working with the Hoffmann MS 35

The attractiveness of wooden windows sometimes also has something to do with their market prices when they are in competition with other frame materials. Therefore particularly efficient and cost effective manufacturing is required.

With processing techniques from Hoffmann this objective can be achieved. High Quality windows made of wood and at attractive prices. The focus is on the classic mitre corner on the frame and sash which is securely jointed with the highly structural and durable connecting element, "The Hoffmann Key".

For safe Woodworking you also need "safe" machinery. All Hoffmann machines with saw units are subject to an EC type examination. This means maximum security for the operator of the machine and safe design for the future. On this you can rely.



Guard closes automatically after starting the processing cycle and re-opens when complete: Clear vision panel retains the dust and chips and scrap end, better operator comfort.



Precision mitre cut without break-out on the cut face.



Fence stop system for longer window profiles up to 4000 mm.

MX 5 NC

Combined NC- Controlled Double Mitre Saw
Equipped with Routers and Drills



The perfect Allrounder when it comes to mitred joints: Sawing, Routing and Drilling in one machine cycle. Wide ranging applications for windows, doors, frames as for furniture manufacture through to node joints in post and beam construction and glass façade elements.

User friendly control panel: All working cycles are freely programmable. The cut length can be entered or retrieved from memory on the 10.4" touch screen panel. USB interface for direct input of the working lists into the machine for example by production schedulers. Variable-free placement of the dovetail slots and drilling positions over the entire cross-section of a work-piece horizontally or vertically or combined. EG. 3 x dovetail slots and 2 x dowel holes.

For Hoffmann Key sizes W-1/2/3/4 and dowel sizes 8 mm.
Working capacity for cross-sections X direction max 210 mm and in Z direction max 140 mm.



Technical Data

Electrical connection	3ph/N/PE 230/400 V 50/60Hz 7.4 kW
Pneumatic connection	6 bar
Motor Saw/ Drill/Router	2 x 2200 W / 4 x 750 W
Motor speed S / D / R	3000 / 12000 / 18000 1/min.
Saw Blade	400 x 30 x 3.2
Control/Clamping	SPS/pneumatic / pneumatic
Cutting capacity	X 120 mm / Z 140 mm
Router/ drill Depth	75 mm / 30 mm (Ø 6/8/10 mm)
Hoffmann Key sizes	W-1/2/3
Dimensions W/D/H	3540/1000/1520 mm
Weight	520 kg
Order No.	M 100 0700

With the experience of recent years, market and product development, and above all the encouragement of our customers has lead to the development of the new machine MX-5 NC. Easy and intuitive operation, flexibility and quality of the individual components. These were the guidelines for the development of this facility. One machine - many applications.

Unrestricted positioning of drilling and routing

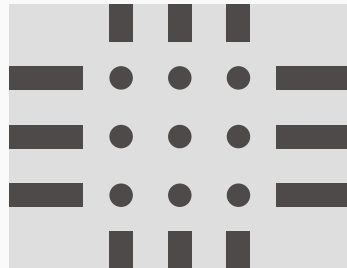

Wireless measuring rod



Barcode reader



Length optimising



Work-piece return table



Safe and user friendly operation



Short-cut device



Automatic angle positioning

Pure efficiency: Two ends can be processed simultaneously with each machine cycle. Cut to size at each end, then cutting the grooves for the Hoffmann Key, and then drilling holes for dowels to stabilize the connection.

MX 2

Combined Double Mitre Saw and Routing Machine



Precise miter cuts, to final size at each end of the work-piece plus double-sided routing of keyways in the faces of one or both sides in a common set-up. For work-piece widths to 140 mm, saw unit can be moved up to 3000 mm cutting length. Dimensional control by visual scale tape or optionally by digital measurement system. Pneumatic saw feed and pneumatic work-piece clamping. Saw and router units on adjustable carriage between +67°/-0°/-45°.

For W-1/-2/-3 Hoffmann Key sizes. Application on doors, cladding, frames and moldings in interior design and furniture.



Technical Data

Electrical connection	3ph/N/PE 230/400 V 50/60Hz 6.6 kW
Pneumatic connection	6 bar
Motor Saw / Router	2 x 2200 W / 4 x 530 W
Motor speed Saw/Router	3000 1/min. / 29000 1/min.
Saw blades	330 x 30 x 3.2
Control/Clamping	pneumatic / pneumatic
Cutting capacity	see diagramme
Router depth	75 mm
Hoffmann Key sizes	W-1/2/3
Dimensions W/D/H	3540/1000/1520 mm
Weight	480 kg
Order No	M 100 0500

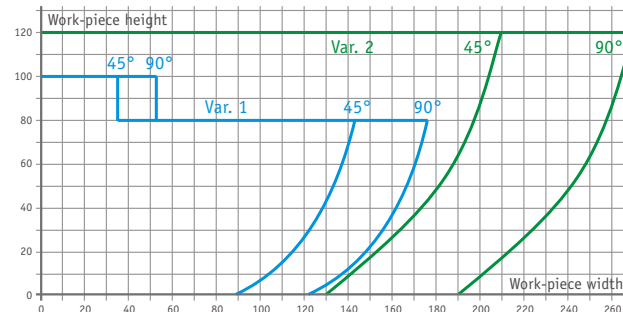

Cutting Diagramme



Saw Station

- 1. Infeed table with clamping units
- 2. Router gearbox
- 3. Drive motors
- 4. Set-up spindle centres

MX 3

Combined Double Mitre Saw and Dowel Drilling Machine



Precise mitre cuts, to final size at each end of the work-piece plus double-sided drilling for dowels in the faces of one or both sides in a common set-up. For work-piece widths to 140 mm, saw unit can be moved up to 3000 mm cutting length. Dimensional control by visual scale tape or optionally by digital measurement system. Pneumatic saw feed and pneumatic work-piece clamping. Saw and router units on adjustable carriage between +67°/-0°/-45°.

For 6/8/10 mm dowel. Application on doors, cladding, frames and moldings in interior design and furniture.

Variation VARIO 3:

1. For precut work-pieces
2. For bar length material.



Technical Data

Electrical connection	3ph/N/PE 230/400 V 50/60Hz 6.6 kW
Pneumatic connection	6 bar
Motor Saw / Router	2 x 2200 W / 4 x 1050 W
Motor speed Saw/Router	3000 1/min. / 10000 1/min.
Saw blades	330 x 30 x 3.2
Control/Clamping	SPS / pneumatic
Cutting capacity	see diagramme
Drill depth	30mm (6/8/10 mm)
Dimensions W/D/H	3540/1000/1520 mm
Weight	480 kg
Order No	M 100 0600



Operators panel with emergency stop button



Saw Station
1. Infeed table with clamping units

2. drill gearbox
3. Drive motors
4. Set-up spindle centres

Engineering Services and Customers Specific System Solutions

Simple and Brilliant

Often, adapted series machines, despite optional modifications are still not suitable for the intended processing purpose. In contrast, work-specific machine configurations are able to realize exactly all the actual production specifications and required workflow.

The Hoffmann-division engineering service (IDL) specializes in implementing individual, efficient process solutions for the work processing of sawing, routing, drilling, assembly and installation.

Hoffmanns engineering expertise covers the following areas

- > Building components (windows, door and interior doors, ceiling, post/beam constructions, conservatories.
- > Furniture (kitchens, wardrobes, wall units, doors, cabinets, beds, tables)
- > Furniture profiles for frames rims, bases, screens, panels and profile bars.
- > Special niche products such as prefabricated houses and sauna buildings, coffins and flooring.
- > Wall elements room dividers.

Generally, these CNC-controlled multi-axis machining techniques are used. For the machine control, in-house bespoke programs or relevant industry software can be used. This convenience is possible due to the Menu-driven PC control with Windows-based touch screen display panel.



SO 7.215 - Automatic Five Axis Routing Machine

Hoffmann often acts as a main contractor when it comes to efficiently designed construction joints. The scope extends from the manufacture of furniture (doors, panels, frames, cornices, carcasses) on to facades and winter gardens (post / beam, trusses), Door production (frame profiles, architraves), wood, wood/Alu-, plastic windows (corner connection for the frame and sash), board processing up to the entire interior (floor, wall, ceiling profiles). Here, not necessarily only the Hoffmann-Keys are used as a jointing means, but also any other types such as dowels or the likes are feasible.

System solution for saws



Filigree bar of 10 mm to 600 mm width of work-pieces can be processed by the Hoffmann-cutting technique. We place great emphasis on cutting accuracy, low material break-out and absolute precision of angle and cut lengths. Blade selection, speed, spindle bearings and many other parameters are fine tuned to the specific customer requirements. This way we achieve your optimal result.

System solutions for routing



The experience of the last 20 years has made us a specialist in routing. We rout your parts - always precise, splinter-free and dimensionally stable. Depending on the particular task, we offer machines for almost every application: Routing on different levels, with special tools, in combination with other processes and much more.

System solutions for drilling



Drilling at different levels, single or with multiple drill heads, in combination with saws or Hoffmann-Keys - we have the solution for your production.

System solutions for jointing technology

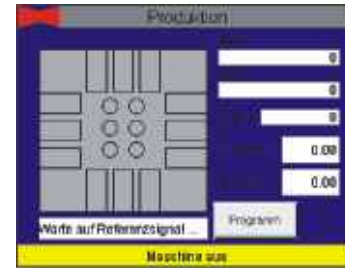

Frame mitre joints are fundamental components in the woodworking industry and require multi-functional techniques. The Hoffmann-Key offers solutions to numerous joining techniques from the glazing bar connection to the heavy post/beam construction. Special machines are designed for the task at hand, developed and built.

System solutions for interlinked processes



Customers in the 21 Century expect excellent products, especially in furniture, windows, doors and construction sectors. This requires machines that are able to work, multi-functional. Combination machines for sawing, routing, drilling with loading magazines, workpiece handling and computer control can be realized by us.

Your requirements are the targets for our technicians. Hoffmann-engineering services (IDL) to optimizing, streamlining, efficiency, quality assurance, cost saving - these are the principle foundations of our development!

SO 7.174

Saw & Router Station



Customer bespoke Machine
Designed for cutting and routing wood profiles in different lengths and different cross-sections.



Special Characteristics

- > 1 Main axis for dimension control
- > Servo driven
- > SPS control
- > Flat bed loading magazine
- > In-feed table for work-pieces
- > Automatic gripper for work-piece positioning
- > Gripping shoe for 13 different work-piece profiles

Work-piece measurement

Width 20 mm - 120 mm, Length 375 mm - 2500 mm, Height 10 mm - 60 mm

SO 7.165

Saw & Twin Drill Automat



Customer bespoke machine to process sawing and drilling of door frames up to 450 mm wide.



Special Characteristics

- > For upright and horizontal parts - left and right
- > 1 Main axis for dimensional control
- > 2 axis alongside for the header part (digital position)
- > SPS control with error detection
- > Two sided processing 90°/45° or 45°/45°
- > Assembly pre-drilling with 2 x 15 spindle heads
- > Automatic removal of the scrap ends

Work-piece measurement (frame width)

to 500 mm, length to 2800 mm

S0 7.215

Automatic 5 Axis Routing Machine



Customer bespoke machine designed for routing slots in decking planks for the jointing system "FoX" tools or screws. Processing the front and sides of each plank in one processing cycle.



Special Characteristics

- > Work-piece magazine for approx. 20 - 30 pieces depending on size
- > Automatic feeding from the magazine to the processing station
- > Processing the ends and sides of the work-piece in one machine cycle
- > Removing the completed piece from the machine
- > Capacity of 250 m2 flooring per shift
- > High repeatability and reliability
- > SPS control with error detection
- > High frequency motors

Work-piece measurement

Width 80 mm - 150 mm, Length 450 mm - 1300 mm, Thickness 22 mm - 38 mm

S0 7.211

Automatic Double Mitre Saw and Drilling Machine



Customer bespoke machine for sawing and drilling of wide profiles - in this case coffin elements. Processing of the side, head and foot boards and framing members of a coffin in one cycle. The sawing of the parts is carried out in two levels.



Special Characteristics

- > 4 axis for the angle positioning of the saw cuts on each end
- > 1 axis (Main axis) to position both work-stations left & right
- > 1 short axis to determine the cut length for the Head part (short work-piece set-up)
- > 2 conveyor belts to remove the off cuts
- > SPS control with operator touch screen panel
- > Servo drives
- > Parameter controls for the work-piece length, with fine calibration, compound angle adjustment, drilling function, control of the return table for the bar length material on conveyor belt, set-up function

Work-piece measurement

Length 250 - 2200 mm, Width 50 - 650 mm

SO 7.128

Saw & Router Automated Work-Station



Fully automatic bar-length machine, for sawing and routing of special profiles. With special stockholding magazine for two different work-piece profiles and automatic feeder.

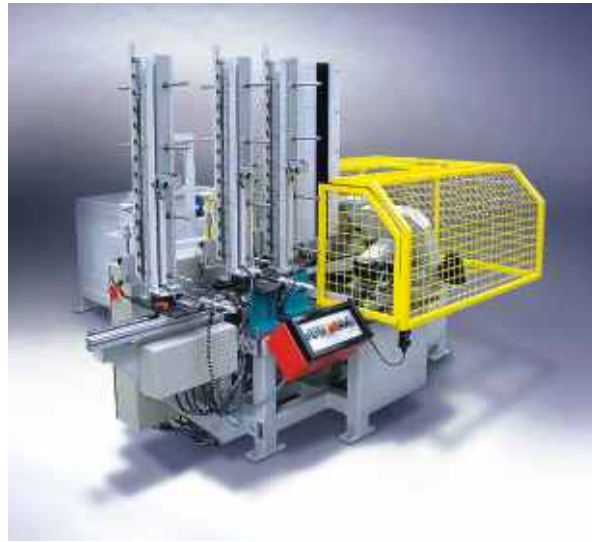
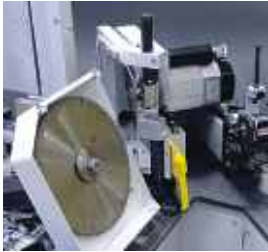

Special Characteristics

- > Work-piece magazine for about 20 to 30 workpieces
- > Floor magazine for the separation of the work-pieces
- > Automatic insertion of parts from the magazine into the machine
- > Cutting, routing the cut surface and off-cutting of the finished part in one cycle
- > Eject the finished parts via a chute
- > Capacity: up to 2000 parts per shift
- > PLC control with error control
- > High-frequency motors

Work-piece measurements

Width 20 mm - 45 mm, Length 100 mm - 300 mm

SO 7.146

Saw / Router / Drilling Work-Station



Special machine for cutting, routing drilling of window frame profiles with manual adjustment and either one or two holes or cutting grooves on each station.



Special Characteristics

- > Machining programs for different routing and drilling configurations
- > Quick-change requirements for different profiles
- > Automatic mirror image of the routing units set-up
- > PLC control with error control
- > Network connectivity optional
- > High-frequency motors
- > Capacity: Up to 640 profiles shift

Work-piece measurements

Width 20 mm - 90 mm, Length 420 mm - 2800 mm, Height 25 mm - 90 mm

ELA 2 - Position Control

Fence stop system

As a roller table or surface table

Automatic length stop as a positioning and locating system. For mounting on saws, routers and boring machines, also available for other brands of machinery. Faster positioning and greater precision for the processed parts = fewer errors and less rejects. Stable base, strong conveyor with material-storage panel, high quality linear bearing drive for quiet, smooth running of the positioning stop. Free choice of roller width and graduation.

Special characteristics

- > Operation on the touch screen panel with 5.4" Display
- > Clear, easy-to-use input menu
- > High speed drives
- > Robust, wear-free linear carriages
- > In-built work-piece counter
- > space for 99 tables
- > USB port for external programming of the system
- > Options: Wireless measuring bar, barcode reader



Operators panel



Roller conveyor with guide and fence stop



Data transfer via Bluetooth
e.g. window bars

Technical Data

Electrical connection	220 V
Display	120 x 150 mm
Measurement range	3000+ mm
Total length	3600 mm
Fuse type	IP 54
Order No	M 310 0000

Accessories

Dovetail Routing Machines & Double Mitre Saws

The original accessories made by Hoffmann offer technical solutions for different applications. Special accessories such as material support, additional clamping devices, special motor wiring etc., upon request.

Accessories - Dovetail Routing Machines

Router motors 230V 50/60 Hz



Motor	530/1000/1700 W
Motor RF	1000/1100 W variable
Motor SF	500 W
Angle router motor	

Routers



Tungsten Carbide Routers 6,35mm

W-1, 6,0/6,35 mm	Router HM
W-2, 6,0/6,35 mm	Router HM
W-3, 6,0/6,35 mm	Router HM
W-4, 8,0/9,5 mm	Router HM

Special Length Routers

W-1, 6,00 mm	HM Special length
W-2, 6,00 mm	HM Special length
W-3, 6,00 mm	HM Special length
W-4, 8,00 mm	HM Special length

Diamond Routers

W-1, 6,00 mm	Router Diamond
W-2, 6,00 mm	Router Diamond
W-3, 6,00 mm	Router Diamond
W-4, 8,00 mm	Router Diamond

Flip-stop



Miniature flip-stop



Chip-breaker



X_line, MU / PU / PP-Series

Collets



Collet	6,00 mm
Collet	6,35 mm
Collet	8,00 mm

Butt-stop Adjust gauge integrated



Internal fences Set, complete



Adjustable fence "Synchro"



22,5°/30°/45° Fence



Extension fences Fence guide extension



Carcase table fence
Adjustable angle setting



Mullion fence



Sliding table carriage
for Hoffmann routing machines

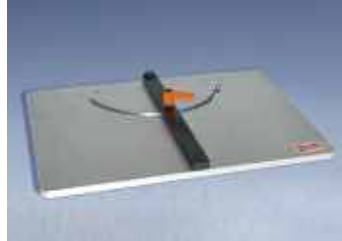

Collet retaining nuts
for 0,5 / 1,0 kW Router Motor



Laser line guide
Battery operated



Double Mitre
Saws

Flip-stop
Pneumatic



Flip-stop
Manual



45° Fence Stop



Butt-stop



Digital
measuring system



Magnetic tape



Saw blades
Standard



Horizontal clamp



Chip-breaker



Chip-breaker, Set, MS-35
Chip-breaker, Set, MS-35-SF

Hoffmann Keys Everywhere

Joining Technology for Windows, Glass Facades, Doors and Building Elements

A mitred corner joint in frames has been always been the recognized as a quality feature for a secure and reliable corner connection. Moreover the miter joint made with the Hoffmann key system can also generally be used for all joints. On the one hand because of the reliability, durability and stability of this system and on the other hand, because of their easy and speedy production method in manufacture.

Due to the intricate and diverse demands from home and abroad, Hoffmann have developed a range of system solutions for joining techniques in building elements. They are found in corner joints for windows, doors, frames, frame parts such as glass beads, cladding and georgean bars as well as node connections for post/bar constructions and glass façade elements.

The services offered, include both design to specific requirements which requires the configuration of the joining system, as well as complementary machine and processing technology. The focus of the manufacturing process or processes relate to the operations of sawing, routing, grooving and drilling.

Here is a selection of application uses for the Hoffmann joining technology already in production: Windows, Glass Facades, Doors and Building Components:

Windows, doors, facades

- > Post/beam construction
- > Glass facades/conservatories
- > Balcony/patio doors
- > Entrance doors, apartment doors
- > Tilt and sliding doors
- > Windows arched, angular, curved

Internal fitting

- > Wood flooring for residential and spa areas.
- > Wall and ceiling panels
- > Cornices and plinths
- > Boarders and cladding
- > Panels on windows and doors
- > Door frames and linings

- > Room dividers
- > Parting and sliding walls
- > Stairs and stair stringers
- > Hand rails and banisters

Outdoor

- > Balcony decking
- > Balcony flooring
- > Balcony planking system
- > Wood flooring for paths, pool surroundings, Sun traps

Feature: Fox, the multi-functional jointer for wood decks (page 11)

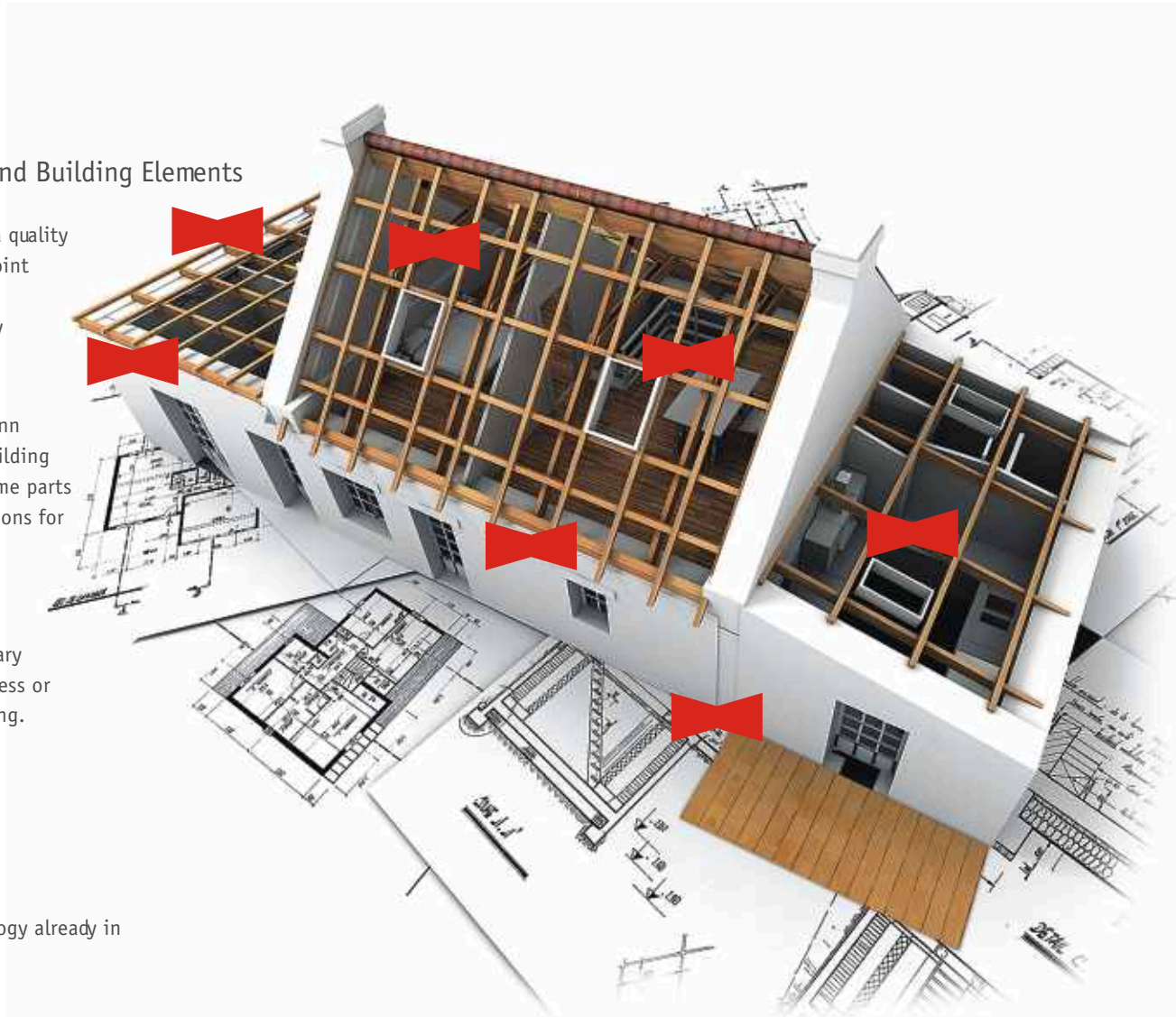

Corner Frame Jointing

Technique and Manufacture

To increase the profitability and efficiency in the manufacture of jointed frames, Hoffmann offer a most extensive range of machines using the dovetail key technology as well as customer specified equipment. Depending on the profile section - for example, relating to the window designs IV 68/IV 78/IV 88/IV 98, etc. - the dimensions and positions of the Keys vary and the correct size and number of Hoffmann Keys must be used. Similarly, with the dowel holes. In total, 78 Hoffmann Key dimensions (length/cross section) are available.

Window Sash

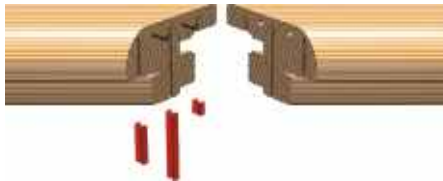

Window Frame

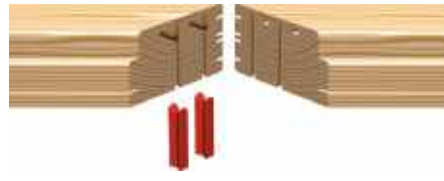

Router and Drill Configuration

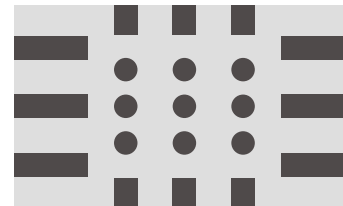

For Efficient Working
Hoffmann MS 35-SF and PP 2-NC



Production Process



Mitre cut the frame profiles to length, router the dovetail slots for Hoffmann Keys and drill the dowel holes. Insert the dowels.



Apply glue to the mitre face, bring the frame parts together and insert the Hoffmann Keys.



Position the pre assembled aluminium frame.



Mitre cut the sash profiles to length, router the dovetail slots for Hoffmann Keys and drill the dowel holes, insert the dowels and keys.



Assemble the sash with glass. Complete the assembly including fitting the seals...complete!

Post/Beam Construction / Node Jointing

Technique and Manufacture

Because of the diversity of architectural design in modern post/beam and facade construction, special demands are made on the manufacturing operations. The quality of the constructed joints and the effective production method is therefore critical to ensure safety and economic efficiency.

The system security is covered by the "Building Inspectorate approval"

More importantly the General Building Inspection Certificate 'of the German Institute for Construction Technology, approves the use of the Hoffmann Key as a safe and efficient method to be used in this building application. The combination of a Key with dowels is the ideal combination system, which has a high load capacity for the post/beam construction and meets more than a static requirement for this component. The authorization covers for façade elements from a profile width size of 50mm upwards. This is towards the current trend for slimmer profile shapes and aesthetic appeal of wood components in support/main and secondary beams, as they are often found in conservatories, buildings or in skeletal frameworks.

Time savings - precision - lasting strength

The node connection, "Keys plus dowels" brings a calculable time saving into the production. When the Key is also glued into the dovetail slot and tapped into place, work can immediately continue without delay. The joint is completely sealed and cannot change even after a long time. The facade elements or skeletons can therefore be assembled according to operational requirements or be sub-assembled on site. Transportation to site in parts also provides obvious cost advantages.

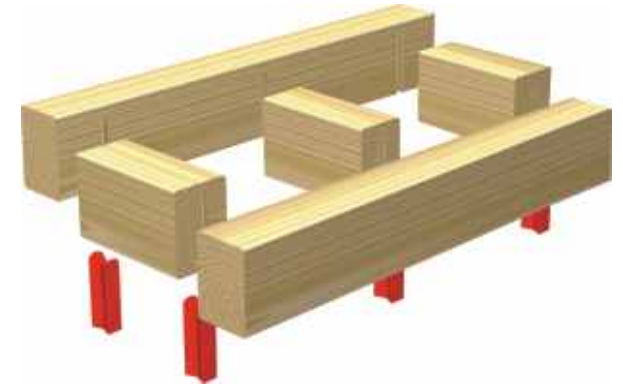

Node Jointing
Hoffmann Key W-4
with 3 dowels



Hoffmann offers a variety of machine models, with options or modifications, which meet the individual criteria for the efficient processing of large-profiles of wood.

Manufacturing Process



Components cut to length. Slots for Hoffmann Keys are routed. Where appropriate, dowel holes are drilled
(with template or routing and drilling machine)



Hoffmann Key W-4 is inserted to complete the joint. Hoffmann Key as specified.



Glass carrier rail, position and screw.



Covering profile, fitted and secured...complete!

For Efficient Working



PU 2-VH



Drilling template

Door Manufacture

Technique and Production

The Hoffmann-Key is used both in the frame corner joint as well as a smart feature detail in manufacturing door sets. Both in the door lining and the architraves. Thus, the frame parts can be assembled within a few minutes quickly and easily. The reason: the double dovetail shape, inevitably draws the frame components tightly together in a secure, permanent accurate joint. Another advantage is: the time-saved when gluing the frame - possible on the site - it is a rapid processing without waiting time.



Further applications of the Hoffmann Keys: glazing bars, square or rectangular glazing cassettes frames, the assembly of door panels.



Manufacturing Process

The example of the modified Drill-/Router work station- SO 7178 to customers own requirements. To process frame parts in one setting.

This work station equipment includes

- > 3 multi spindle heads for door hinge preparation
- > 1 striker plate routing station
- > 1 pocket hole router for lock and lever mechanism
- > 1 striker plate drilling station
- > 2 router stations to process for Hoffmann Keys at each end of the doorframe element



Skeletal Frame Construction

Technique and Production

Extensive roofs are being constructed increasingly using quality wood. The substructure of the roof panels are usually designed as a skeletal construction - divided into sections. The nodes are connected in such a case with Hoffmann-Keys W-4.



St. Davids Shopping mall in Cardiff/UK



The framework supports for the ceilings, with fire-resistant panels, are constructed as a classic wood frame structure.



Hoffmann-Keys W-4 used at the node joints, ensure that the meeting edges of the carrier fit and that the panels form a common flat plane.

Certification and machine safety

Your Safety

Customer satisfaction is our first basic precondition all our activities and behavior. This includes in particular your safety when working with our products. Test controls and certification, is why we have both the Hoffmann-Keys and the machine technology examined and approved by renowned and internationally recognized research institutions and testing laboratories.

Building Inspection Approval
 German Institute for Building Technology



- Approval for Hoffmann-Key W-4 for general use in timber
- > Hoffmann Key plastic version (PA)
 - > Hoffmann Key oak laminated three layer

Certificate Suitability for Service
 Regional Direction Ile-de-France (France)



- Approval of windows with mitred corners
- > Resistance to wind load, to static torsion against vertical load
 - > air permeability, water tightness

Certificate Suitability for Service
 eph - Development and Wood technology laboratory



- Approval of windows with mitre corners
- > Resistance to wind load, to static torsion against vertical load
 - > air permeability, water tightness
 - > Heat transfer coefficient U w (window) / U (frame)

Hurricane Test
 Miami Dade County, Florida (USA)



- Approval for windows with mitred corners in areas threatened by hurricanes
- > Pressure and suction withstand
 - > water tightness of the corner joint
 - > Air and water sealing at high wind speeds

Innovation Award the county Baden-Württemberg



- "Dr. Rudolf-Eberle-Prize" (Former Minister of Economy Trade and Technology)
- > Special award for innovative machine technologies

Information & Services

Today, rapid response and flexibility is required - even in our area. Wherever our advice is required, we offer our customers information about our products, partnerships and support.



Catalogs

We also offer to our catalogs specific detailed theme catalogs and detailed brochures.

Images / Videos

Our pictures and video library offers an overview of our services.

Publications

A complete collection of product reviews and articles are available for you.

www.hoffmann-schwalbe.de

Visit our home page

www.hoffmann-schwalbe.de

There you will find many more interesting facts about The Hoffmann products.



Prototype test certificate
DGUV test



Prototype test certificate
BG



Prototype test certificate
TÜV



Testing and certification agency
Technical Committee for Wood

- > To test the Double Mitre Saw MS 35-SF with additional extension and cross-cut saws

BG test certificate

- > To test the Double Mitre Saw MS 35

TÜV Product Service

- > To test the machines with manual in feed to saws type "X_Line 50/60/70 "

Science meets practice

- > TÜV-Stuttgart
- > Universität Karlsruhe
- > eph-Dresden

- > Fachhochschule Biel/CH
- > Deutsches Institut für Bautechnik
- > Professional association



Hoffmann GmbH Maschinenbau

Mergelgrube 5 · D-76646 Bruchsal

Tel. +49 (0) 72 51 - 95 44 0

Fax +49 (0) 72 51 - 95 44 44

Home www.hoffmann-schwalbe.de

E-Mail info@hoffmann-schwalbe.de



Were found in the
best joints...worldwide!