

Compact Dimensions – Maximum Performance

TECTRA 6120

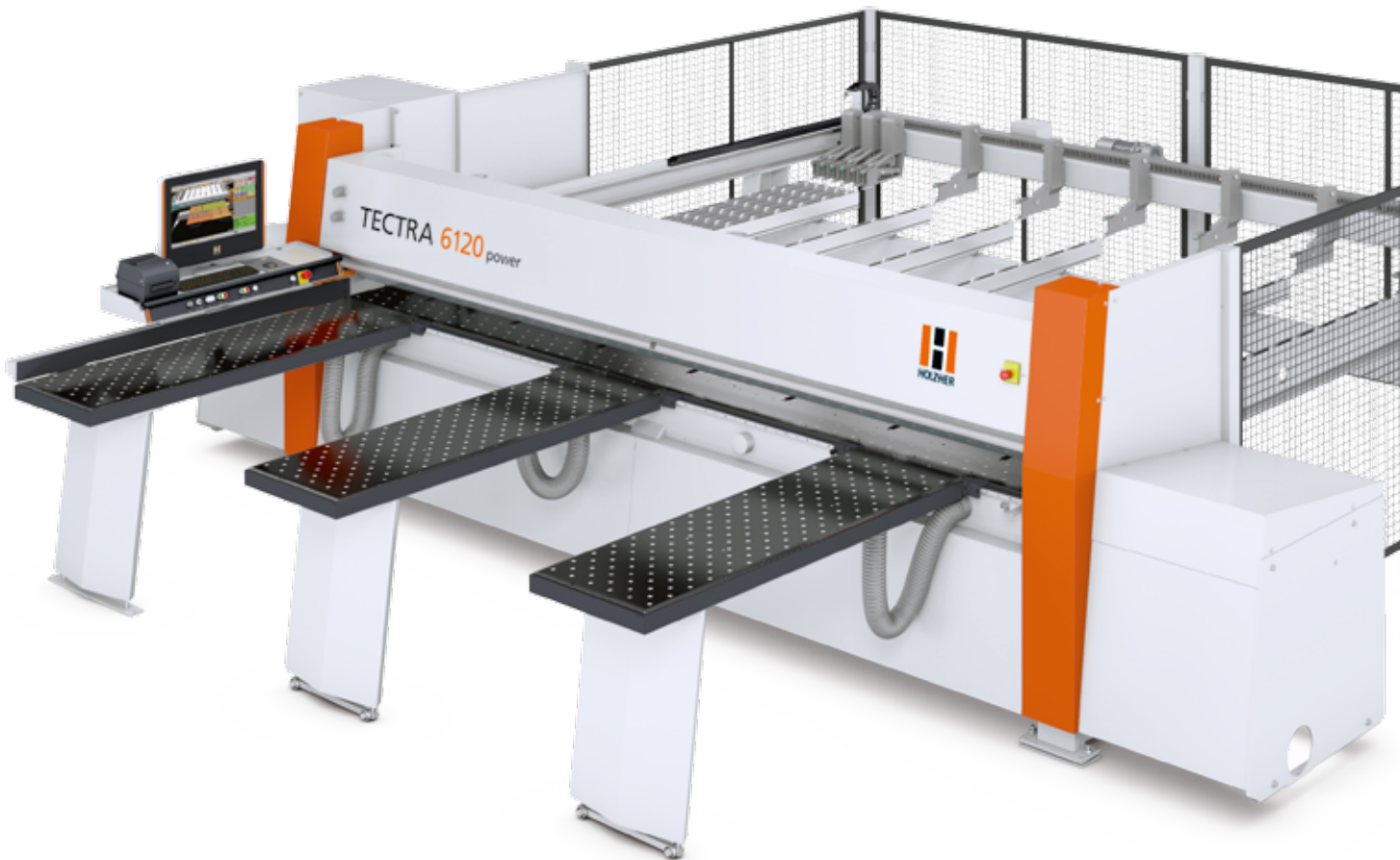

PRODUCTIVITY AND PRECISION





Perfect panel processing is our passion

Our engineers are among the world's best. Their visionary imagination and exceptional skill guarantee that our machines are the highest performance, most flexible and safest in the world today. Customers appreciate our capability to develop and produce excellent products quickly at equitable prices and high quality. Integrative, networked solutions are decisive for machining wood and panels worldwide.

This is why HOLZ-HER offers a range of products matched to one another and always develops a complete product series, from

an entry-level machine right up through all performance ranges to the comprehensive top model. All service activities and product training courses are planned alongside new products. This ensures that, in addition to being offered a new machine, customers can also take advantage of a complete range of services. This focuses on practical solutions and greater customer benefit.

Absolute precision in
production guarantees
perfect results for customers.



What you can expect from us

- We want to understand our customers and partners as well as we possibly can and we want to optimize and increase their success by providing them with innovative products and services.
- Close contact with our dealers as well as with end customers, cabinet makers, interior architects and industrial workshops is one of HOLZ-HER's particular strengths.
- HOLZ-HER places a great deal of value on providing above-average performance in all areas, looking ahead to the future, achieving continuity and consistency in development and design and perfecting production, as well as providing in-depth sales and service advice.
- The ability to recognize and anticipate trends is a key skill for strong companies like HOLZ-HER. This requires the qualifications of each and every employee to be kept up to date. For this reason, HOLZ-HER places a great deal of emphasis on professional training for young employees. A choice selection of advanced occupational courses and personal training keep the learning process going.



The WEINIG Group: Machines and systems for solid wood and panel processing

Innovative state-of-the-art technology, comprehensive services and system solutions through to turnkey production lines: the WEINIG Group is your partner for profitable processing of solid wood and panels. WEINIG quality and profitability give small businesses and industrial operations a decisive edge in the global competition.



The saw with the high performance range

The TECTRA 6120 series beam saws impress with their high performance. They are variable, compact and therefore even fit in shops where work areas require extremely economic planning. Nevertheless their cutting performance is far beyond standard. The free-supporting, torsionally rigid design of the base frame as well as the high quality equipment are distinguishing features of these panel cutting saws.

- Saw carriages, sawing units and rip fences are held precisely by ground V-guides, preventing vibration. This ensures clean and precise cuts over the long term.
- Electronically-controlled saw carriage, depending on the model, for extremely short cycle times and a high level of productivity. Also ideal as cutout equipment e. g. for precise grooves.
- Infinitely variable feed rate of 0 to 130 m/min (up to 70 m/min for the classic).
- Saw carriage return speed of up to 130 m/min (up to 70 m/min for the classic).
- The high quality rack-and-pinion drive offers high acceleration rates and rapid operating cycles without effort.
- Rip fence return speed of 100 m/min, positioning speed of 25 m/min (CE).
- Electronically-controlled pressure beam with optimized hub for short cycle times.
- Air cushion support tables and machine table depending on the model – for easy and careful material handling of heavy panel stacks.
- Enables perfect solutions for charging and lifting table or storage systems. The dynamic and lift versions are ideally equipped for charging thanks to the storage system and lifting table.



Illustrations may contain optional features.



Brilliant simplicity –
simply brilliant.
Just three clicks and
my cutting begins.

Your cutting – perfect and efficient

Automatic cutting

- Improved and easier handling.
- A1 quality of cuts.
- Shorter machining times.

Energy management

- Low energy consumption through efficient use.
- Fewer emissions.
- Optimized extraction technology.
- Software-controlled efficiency checks.

Simple work preparation

- Optimization software.
- Production schedule planning.
- QuickWorks – the perfect optimization assistant.
- Pre- and post-calculation.
- Material management.

Complete solutions

- Optimally prepared for charging systems, lifting table solutions and storage systems.
- Perfect for machine networking.



The intelligent energy management system – standard on all HOLZ-HER panel cutting saws.

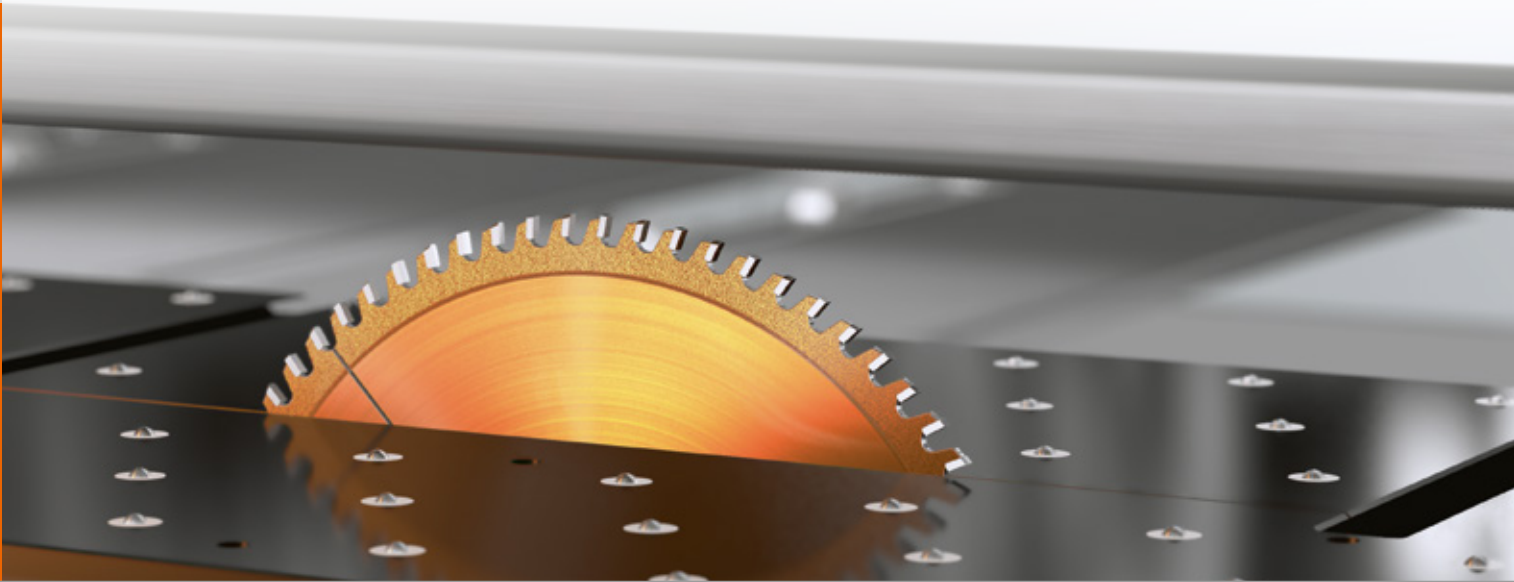

TECTRA: The right step for the perfect cut

Automation of the operating procedures

- Data transfer from third-party programs.
- Three clicks to cut.
- Rapid and simple creation of cutting plans.
- Higher performance in cutting.
- The path to correct work preparation.
- Pre- and post-calculation of the cutting jobs.
- Ready for connection to third-party software and storage systems.
- Simple operation – rotating and swiveling control panel at eye level.

Fast and reliable

- Most rapid programming of its type.
- Clear machine control.
- Simple and uncomplicated operation.
- Equipped for all your projects.
- Overview of order workload.
- Cost assessment.
- Proven safety for your employees.
- Harmonized workplace.
- Perfect ergonomics for your employees.
- Perfect, uniform cutting.

This is what your customers
can expect from TECTRA.



We show you the easy step-by-step
path to the perfect cut.

The software for any order

Perfect
work preparation

Unique
interface solution

SOFTWARE PACKAGE IN OFFICE



HOLZ-HER **Orbit**

Orbit gives you total control of the HOLZ-HER software modules. Switch easily between the various windows and maintain an overview of your production.

Pre- and post-calculation
at the touch of a button

Seamless connection
to your machine

Orbit

Equipped for all orders,
whether large or small



To the machine
with one click

Cutting optimization

Perfect utilization of material and high output thanks to intelligent software. Know your material and production costs now.

Production planning

Plan the production – monitor the manufacture. Also the perfect tool for post-calculation.

The HOLZ-HER software package –
the comprehensive solution for your cutting.

SOFTWARE PACKAGE ON THE MACHINE

Saw blade protrusion
up to 95 mm

Sawing unit
up to 15 kW



QuickWorks

Three clicks to the finished cutting plan:

- Import the order
- Optimize the order
- Cutting plan on the machine

The cutting can begin.

Direct cutting

Rapid implementation of
individual and serial cuts.

Simple operation and identification of all parts

Rapid cutting cycles

Unlimited number of orders

Manufacture that inspires



OptiCut

High-performance optimization solution with material management (option for classic).

EasyPlan

The quick and simple tool for optimization at the machine.

CutControl 2

A perfectly designed workplace forms the basis for efficient and effortless work. Using the 21.5" control terminal, HOLZ-HER panel cutting saws meet all of a machine operator's requirements. The ergonomically adjustable shelf gives you the means of positioning up to two printers, scanners or keyboards for user friendliness.

- The 21.5" graphic user interface guarantees the largest possible overview with 3D real-time graphics and complete graphical processing support.
- The optimized display of information impresses in terms of "overview" (keys and functions that are not required are faded out).
- The self-explanatory interface is an essential feature of this, so that your employees can work properly and rapidly with the machine without a significant training outlay.
- Operating statuses, service and maintenance intervals and separately programmed energy management are displayed in real time.



> Control from
experience –
for practice. <



- To be able to operate the CutControl even more easily and effectively, the TECTRA can be equipped with an optional touchscreen. The entire operation of the interface is adjusted for use by touch.
- All operating elements are laid out for ideal operability by mouse or by touch.
- Remote maintenance assistant, video monitoring, USB connection or use of many Windows support programs, as you would expect!

Perfect data flow in the HOLZ-HER programming network

- Programming
- Sawing
- Edgebanding
- CNC machining



DETAILS

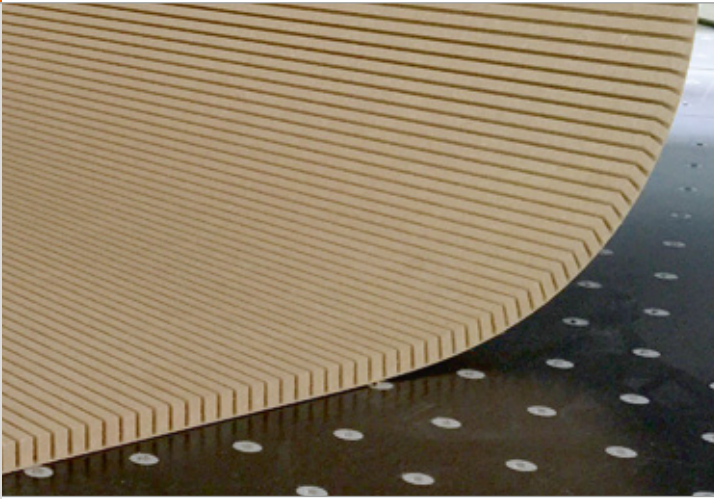

Bidirectional grooves

Using graphic groove and recess programming, you can create your desired components in the shortest possible time and see the programmed cutting result in real time. For you, this means a significant time gain, thanks to the bidirectional cutting sequence of your HOLZ-HER saw for grooves. Precise grooves are cut in the forward and reverse directions and valuable production time is saved.



Labeling system

The labeling module gives you the means of designing labels perfectly matched to your manufacture. Logo, bar code or data matrix code – create your individual label or use a predefined label.



Remnant management

From cutting to the printing of labels, the whole procedure is completed automatically, during which all remnants are checked in or out automatically. Even remnants that are added or removed manually can be managed seamlessly by the system.

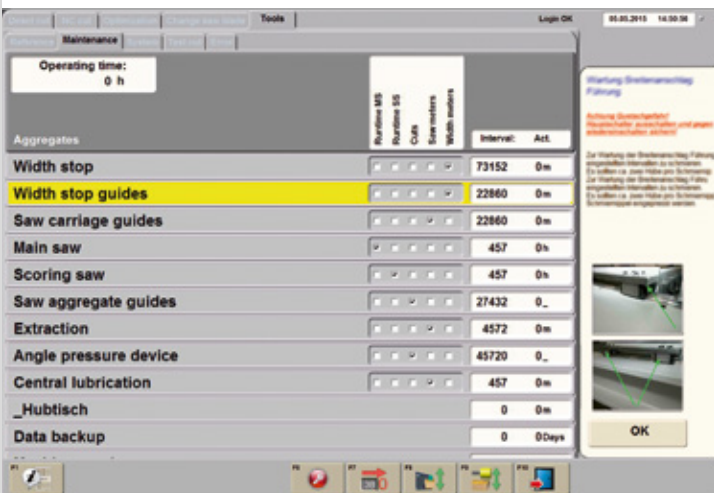

Maintenance and service wizards

Detailed and easy-to-understand service and maintenance wizards in clear text and as picture guidelines for simplest implementation of all maintenance intervals.



MULTISTORE

“MultiStore” storage management offers cost savings and efficiency

With the “MultiStore” storage software from HOLZ-HER, you have all panel formats and even remnants firmly under control. You save a significant amount of material and no longer need to carry out time-consuming searches for remnants. Using the mobile “MultiScan” hand-held scanner, simply scan the bar code of the panel and see immediately on the display whether this part is available or if it has already been reserved for another order.

■ Remnant management

Fully-automatic check-in and check-out during cutting. Manual check-in and check-out of parts that are required.

■ Compartment fill display

The warehouse manages filling of the remnants box independently. You therefore maintain an overview of your operations and save valuable panel material.

■ Label printing

Even the labels for remnants can be designed as you require and ensure clear identification of the leftover pieces.

■ Bluetooth and wireless communication

The hand-held scanner equips you for future generations; whether Bluetooth or Wifi, the hand-held scanner can handle both platforms.



TECTRA 6120 power and TECTRA 6120 classic

Reliable partner for optimum cutting

With the TECTRA 6120 power and TECTRA 6120 classic beam saws, HOLZ-HER has introduced a new era in equipment and precision for cutting for craftsmen and in shops with several individual and stack cuts.

■ Saw blade protrusion

The panel cutting saws of the TECTRA 6120 have a saw blade protrusion of 95 mm (82 mm for the classic) and are equipped as standard with a powerful 11 kW motor (7 kW for the classic). For greater performance, particularly for stack cutting, the TECTRA can be equipped with an optional powerful 15 kW drive (11 kW for classic) (Fig.1).

■ Intelligent workpiece clamps

The solid clamps are also available equipped with an optional intelligent control for the TECTRA 6120 power. For you, this means better cycle time and cutting quality (Fig. 6).

- Automatic, individual switch-on of the clamps by the cutting plan.
No damage to the outside panel edges as the size of the workpiece is checked in advance and only the necessary clamps are used for tension.
- Automatic, infinite pressure control using material parameters.
- Safety circuit in the front access area.
- Highest level of safety for you and your machine operators.

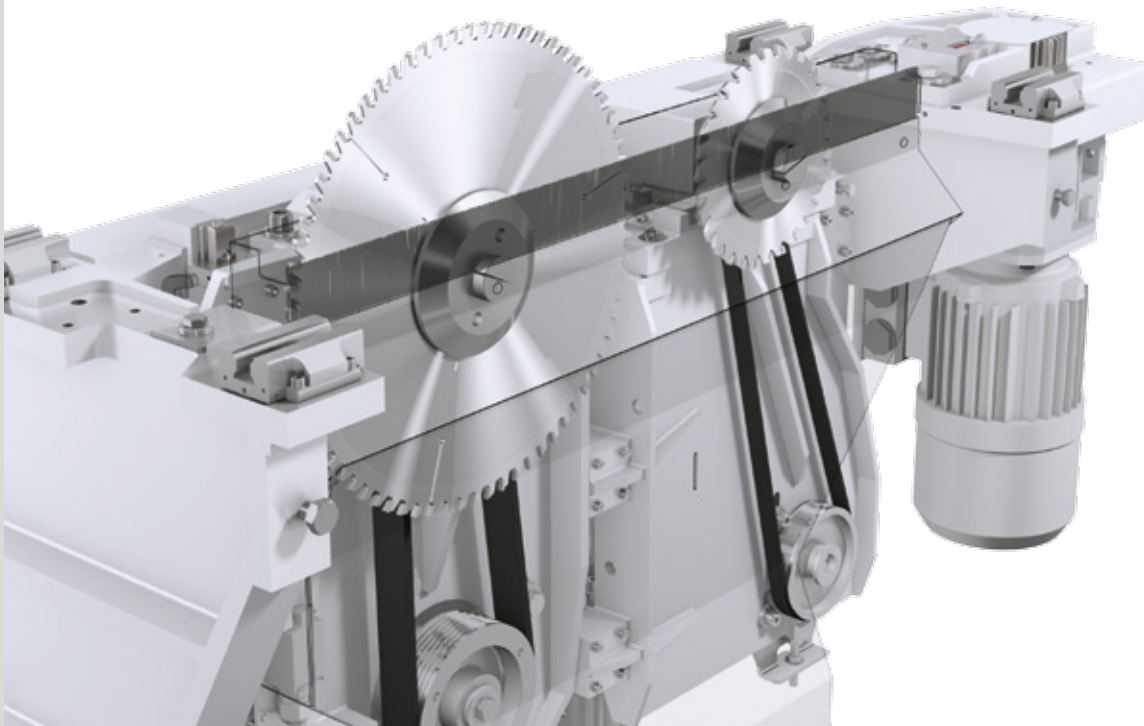

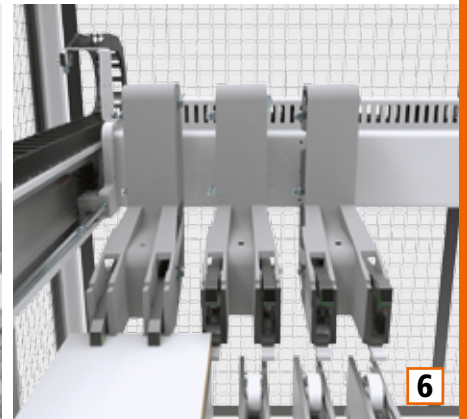
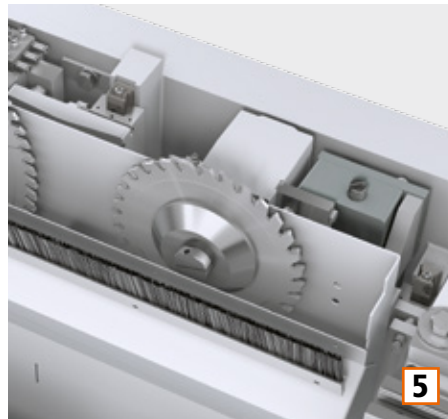
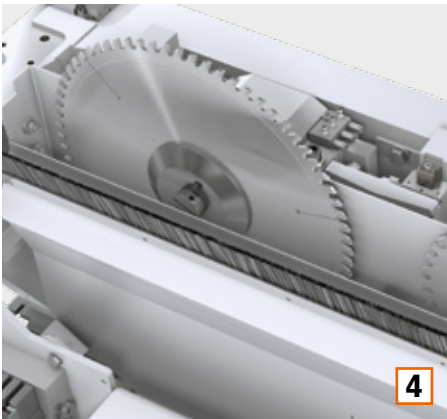
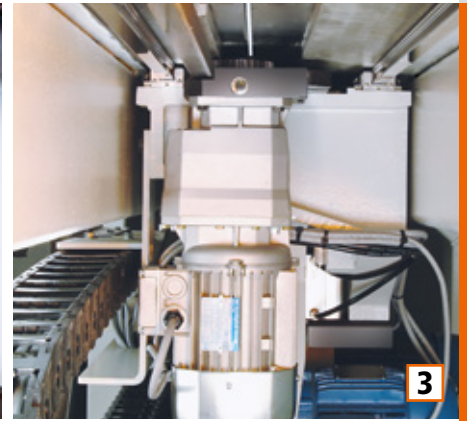
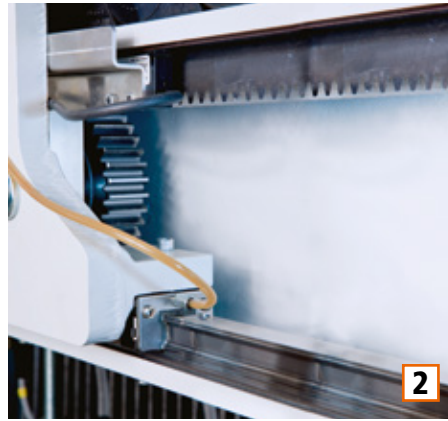

■ Electronically positionable scoring saw

The position of the scoring saw on the TECTRA 6120 can be adjusted precisely on the control panel using the two motor-driven positioning axes for height and lateral adjustment. Valuable changeover time is saved in this way and a perfectly cut product is guaranteed (Fig. 5).

■ Electronically positionable grooving unit

The bidirectional grooving unit provides infinite adjustment for groove depths as deep as 30 mm. This function contributes to a significant time saving when manufacturing wide grooves and flexible panels, due to grooving in forward and reverse directions (Fig. 4).

■ Feed speed

Infinitely adjustable feed rates of up to 130m/min at the saw carriage ensure short cycle times. The solid design of the machine stand, the optimized extraction duct and the precise direct drive ensure optimum, uniformly cut products (Fig. 3).

■ Linear guides

Even in the classic version, TECTRA 6120 provides precision technology with ground linear guides on the saw carriage, on the sawing units and on the rip fence. A direct rack-and-pinion drive and proximity-type sensor for absolute dimensions guarantee maximum positioning accuracy (Fig. 2).



Only with HOLZ-HER
10 year guarantee
on all linear guides.



TECTRA 6120 classic – perfect cutting for craftsmen

■ Workpiece clamps

The TECTRA 6120 classic has the first three workpiece clamps assembled closely, specifically for strip cutting. All clamps are mounted floating and can compensate for irregularities in panels/stacks by means of a linear guide (Fig.1).

■ Angle pressing device (pneumatic)

The pneumatically-controlled angle pressing device (up to a maximum of 1200 mm) holds the workpieces securely and carefully in position, guaranteeing an exact cut, even with long workpieces. Optional program-controlled and route-optimized devices are also available (infinitely up to 1200 mm). The time saving due to prepositioning is demonstrated in shorter cycle times and increased saw output (Fig. 2).

■ Stable support tables

For simple and careful handling of your panel material. When handling heavy panels or stacks of panels, the optional air cushion table is recommended (Fig. 3).

High operating convenience:

Optionally each TECTRA provides movable support tables which can be adjusted easily and precisely on linear guides.

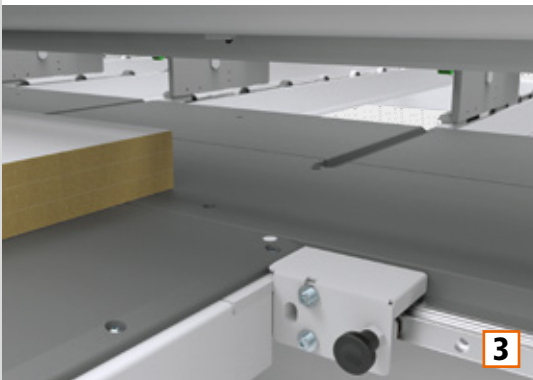
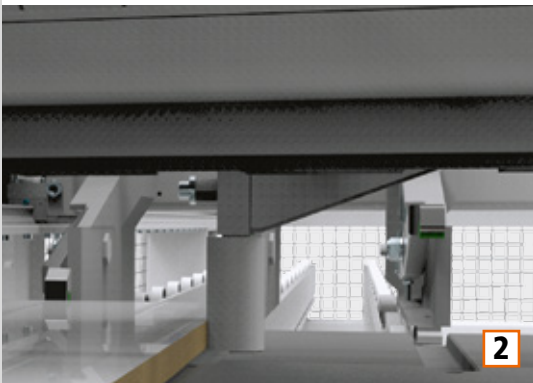
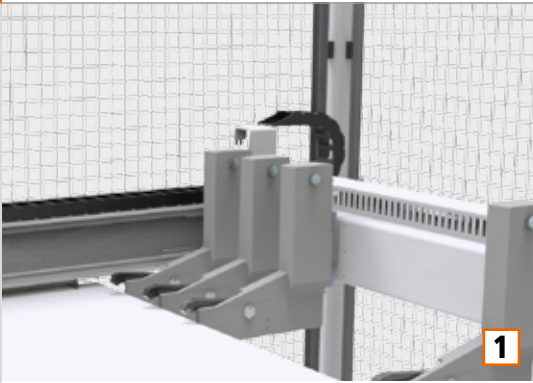



TECTRA 6120 power – the variable all-round solution for your operations

■ Double-finger workpiece clamps

Three double-finger workpiece clamps in the stop area of the TECTRA 6120 power allow narrow strips to be cut simultaneously with maximum stability. The floating type clamps compensate for tension in the panel stack using a linear guide (Fig. 4).

■ Angle pressing device (program-controlled)

The program-controlled angle pressure unit with rubberized, ball bearing pressure roller presses the material to be cut against the solid stop guide gently and precisely at right angles to the cutting line. For additional hold in the remnant cutting area, the TECTRA 6120 power can be equipped with the optional TwinPress system, with two rubberized pressure rollers (Fig. 5).

■ Solid air cushion table

The air cushioned machine tables ensure easy and gentle handling on the support tables with an air cushion before and after the cutting line. For more space when machining serial cuts, all support tables can be exchanged for the optional 2400mm version (Fig. 6).

■ Trimming stops

For precise cutting e. g. on unveneered workpieces, optional pneumatically-controlled trimming stops are available (Fig. 7).

Useful extra for the TECTRA 6120 dynamic:
Additional lateral alignment on roller table for angular layout of narrow and long parts on the extended stop fence behind the cutting line.

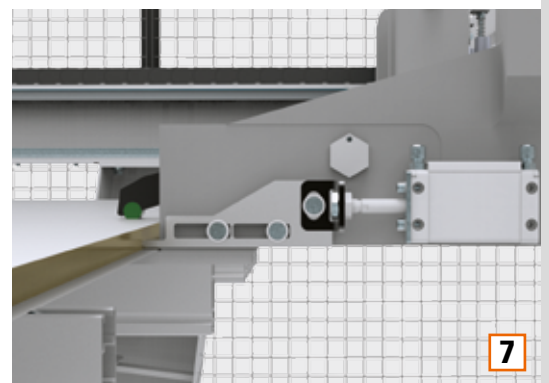
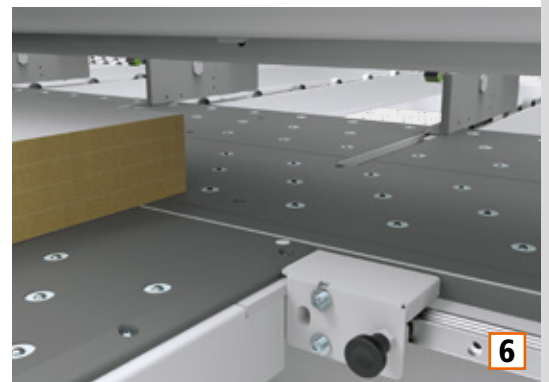
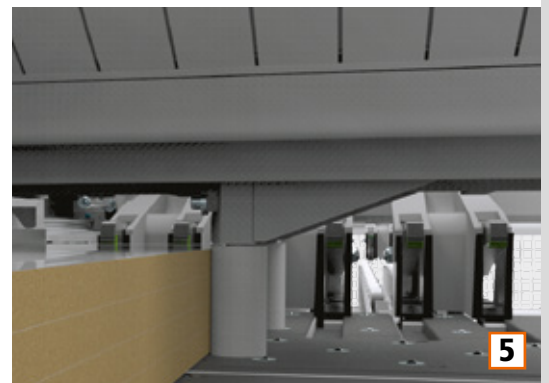

Charging and handling systems

For individual and efficient production

Customer requirements have been changing. Our modern society with its many cultural influences is reflected by highly divergent tastes. Custom solutions, taking the personal lifestyle of the customer into consideration, are the strength of small cabinet-making shops. However economical handling of small batches is also expected from industrial shops today. A variety of decors, veneers and new

types of panel materials poses the problem of storage and effective handling of such material for all shops. HOLZ-HER is your competent partner in this sector and a pioneer for innovative solutions in automation of panel and material handling with very high savings potential. Profit from our expertise and make your production more profitable.



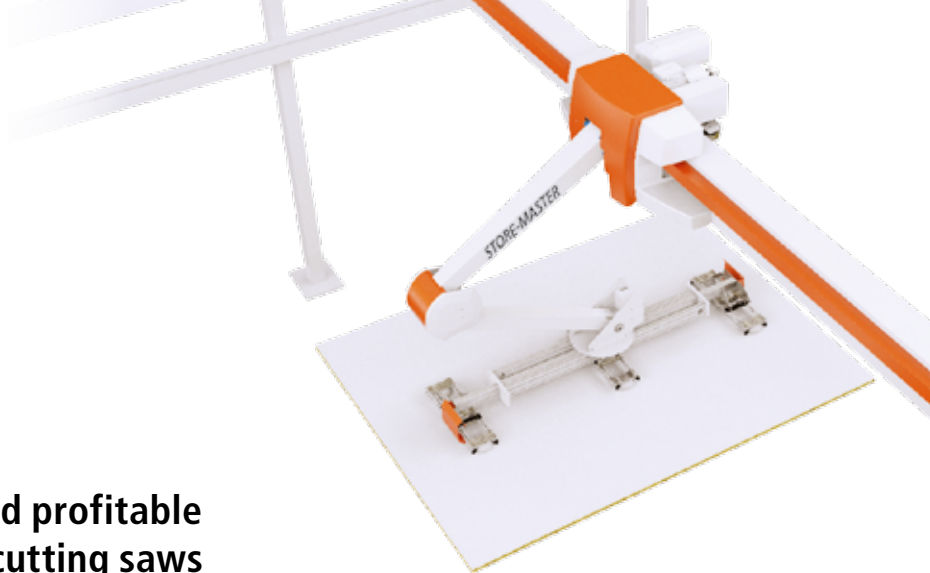

State-of-the-art and profitable charging of panel cutting saws

HOLZ-HER storage systems offer fully automated and intelligent processes as well as highly efficient use of available storage space. Mature, fully integrated software with chaotic storage management increases production capacity enormously.

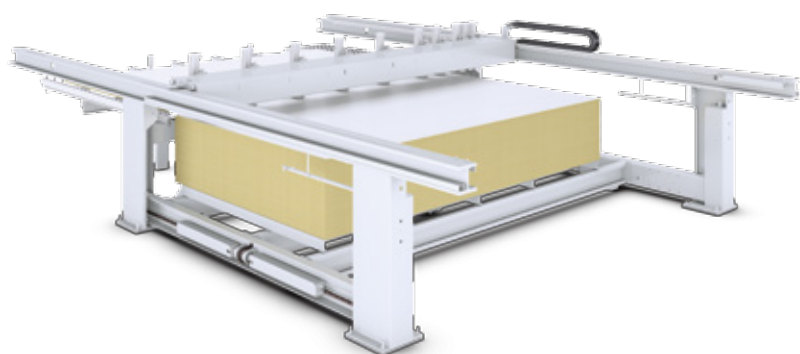
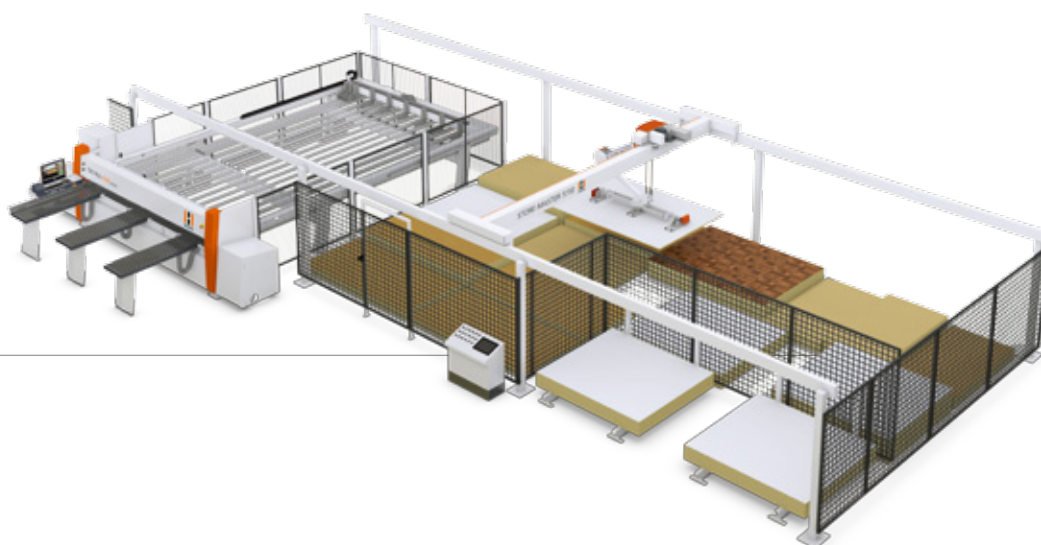

The lift solution for maximum material throughput

Solid precision lifting table for high-capacity mass production. The small space requirement and enormously high supporting capacity enable high-speed processing at high material throughput rates using package cuts. Select the appropriate version for optimal integration into your production process.

TECHNICAL DATA

TECTRA 6120	classic	power	dynamic	lift
Charging	x	Via vacuum storage system	Via vacuum storage system	x
	x	x	x	Via lifting table
	x	Stack aligner	Stack aligner	Stack aligner
Saw blade protrusion	82 mm	95 mm	95 mm	95 mm
Main sawing unit	7.5 kW	11 kW	11 kW	11 kW
	350 mm, Dia. saw blade	380 mm, Dia. saw blade	380 mm, Dia. saw blade	380 mm, Dia. saw blade
	11 kW	15 kW, Speed control	15 kW, Speed control	15 kW, Speed control
	Automatic cutting length	Automatic cutting length	Automatic cutting length	Automatic cutting length
Scoring unit	2.2 kW	2.2 kW	2.2 kW	2.2 kW
	180 mm, Dia. saw blade	180 mm, Dia. saw blade	180 mm, Dia. saw blade	180 mm, Dia. saw blade
	x	Speed control	Speed control	Speed control
	Electronic adjustment	Electronic adjustment	Electronic adjustment	Electronic adjustment
Post-forming	x	280 mm, Dia. saw blade	280 mm, Dia. saw blade	280 mm, Dia. saw blade
Groove cutting equipment	Electronic positioning	Electronic positioning	Electronic positioning	Electronic positioning
Saw carriage feed rate Forwards Backwards	1 – 100 m/min 100 m/min	1 – 100 m/min 130 m/min	1 – 100 m/min 130 m/min	1 – 100 m/min 130 m/min
Rip fence Positioner speed Return speed	25 m/min 100 m/min	25 m/min 100 m/min	25 m/min 100 m/min	25 m/min 100 m/min
Workpiece clamps	3 Strip clamps	3 Double-finger clamps	3 Double-finger clamps	3 Double-finger clamps
	2–6 Pieces	2–6 Pieces	2–6 Pieces	2–6 Pieces
	x	Intelligent workpiece clamps	Intelligent workpiece clamps	Intelligent workpiece clamps
	x	Angle cut clamps	Angle cut clamps	x
Angle presser	Pneumatic (1 roll)	Controlled (1 roll)	Controlled (1 roll)	Controlled (1 roll)
	Controlled (1 roll)	TwinPress, controlled (2 rolls)	TwinPress, controlled (2 rolls)	TwinPress, controlled (2 rolls)
	x	x	Lateral aligner in the roller table	x
Machine and support tables	Without air cushion	With air cushion	With air cushion	With air cushion
	With air cushion	x	x	x
	Additional support tables	Additional support tables	Additional support tables	Additional support tables
Trimming stops	Pneumatically-controlled	Pneumatically-controlled	Pneumatically-controlled	Pneumatically-controlled
Screen 16:9	21.5"	21.5"	21.5"	21.5"
	21.5" Touch	21.5" Touch	21.5" Touch	21.5" Touch
Control	CutControl	CutControl	CutControl	CutControl
Optimization	EasyPlan	EasyPlan	EasyPlan	EasyPlan
	Office package	Office package	Office package	Office package
	HOLZ-HER Orbit	HOLZ-HER Orbit	HOLZ-HER Orbit	HOLZ-HER Orbit
Label system	Printing software	Printing software	Printing software	Printing software
	Label printer	Label printer	Label printer	Label printer
	Bar code scanner	Bar code scanner	Bar code scanner	Bar code scanner

Standard

Optional

x

Not possible

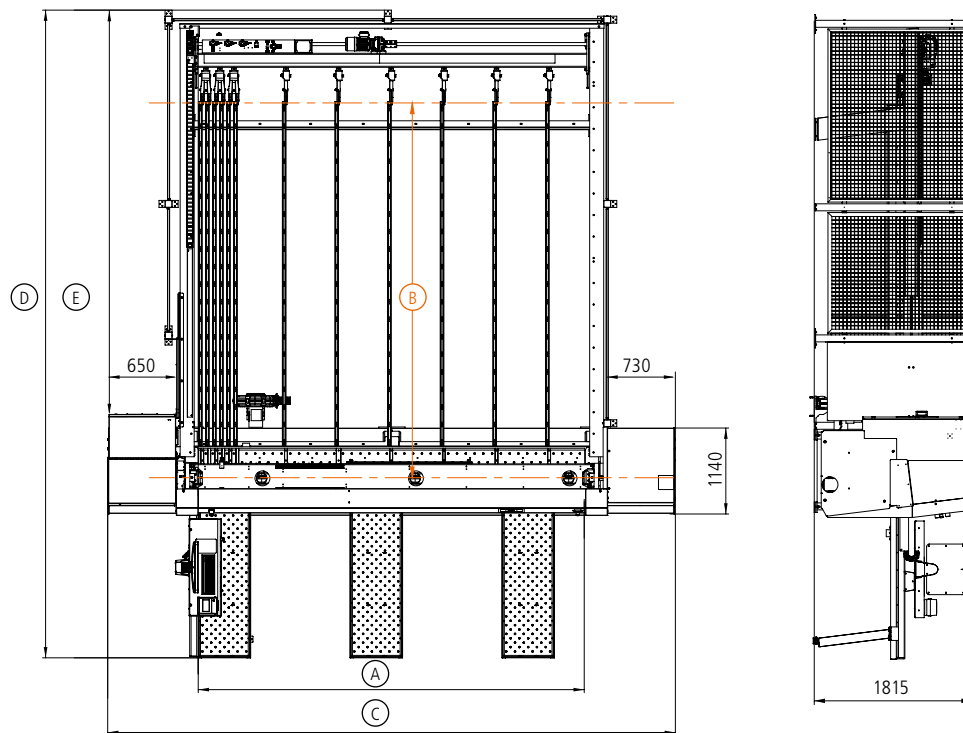

TECTRA 6120	A (Cutting length)	B (Cutting width)	C	D*	E	Weight
classic						
3100 x 3100	3100 mm	3100 mm	5170 mm	6215 mm	3440 mm	4100 kg
4400 x 3100	4400 mm	3100 mm	6470 mm	6215 mm	3440 mm	4700 kg
4400 x 4250	4400 mm	4250 mm	6470 mm	7315 mm	4540 mm	4900 kg
power						
3100 x 3100	3100 mm	3100 mm	5170 mm	6215 mm	3440 mm	4100 kg
3100 x 4250	3100 mm	4250 mm	5170 mm	7315 mm	4540 mm	4300 kg
4400 x 3100	4400 mm	3100 mm	6470 mm	6215 mm	3440 mm	4700 kg
4400 x 4250	4400 mm	4250 mm	6470 mm	7315 mm	4540 mm	4900 kg
dynamic						
4400 x 4250	4400 mm	4250 mm	6470 mm	10,565 mm**	7790 mm**	5000 kg
4400 x 6500	4400 mm	6500 mm	6470 mm	9815 mm	7040 mm	5500 kg
lift 2200						
4400 x 4200	4400 mm	4200 mm	6470 mm	9990 mm	7215 mm	6200 kg
lift 2500						
4400 x 4200	4400 mm	4200 mm	6470 mm	9990 mm	7215 mm	6300 kg

*with support table 1800 mm | **with free space for belt conveyors

Product brochures and many
videos are available at
www.holzher.com

The technical data specified is intended for reference only. HOLZ-HER woodworking machines are subject to constant development and are therefore subject to modification without prior notice. The illustrations are therefore not binding. Some of the machines shown also contain special equipment not included as a standard feature. For clarity, some of the machines are shown without protective hood.

Picture credits:

»Werbefotografie Weiss«;

»Deutschland, Bayern, München, Männer und Frauen diskutieren im Büro« © Westend61 – Fotolia.com;

»Geschäftsleute in Bürogemeinschaft« © Westend61 – Fotolia.com

UK – HOLZ-HER 3545 45 – Printed in Germany/Imprimé en Allemagne
Printed on: 10.05.2017 – First edition: 06.05.2015

Your authorized HOLZ-HER dealer

**HOLZ-HER GmbH**
Plochinger Straße 65
72622 Nürtingen
Germany
T +49 (0) 70 22 702-0
kontakt@holzher.com
www.holzher.com

HOLZHER

A member of the WEINIG Group