

Edition 2200 edge banding machines

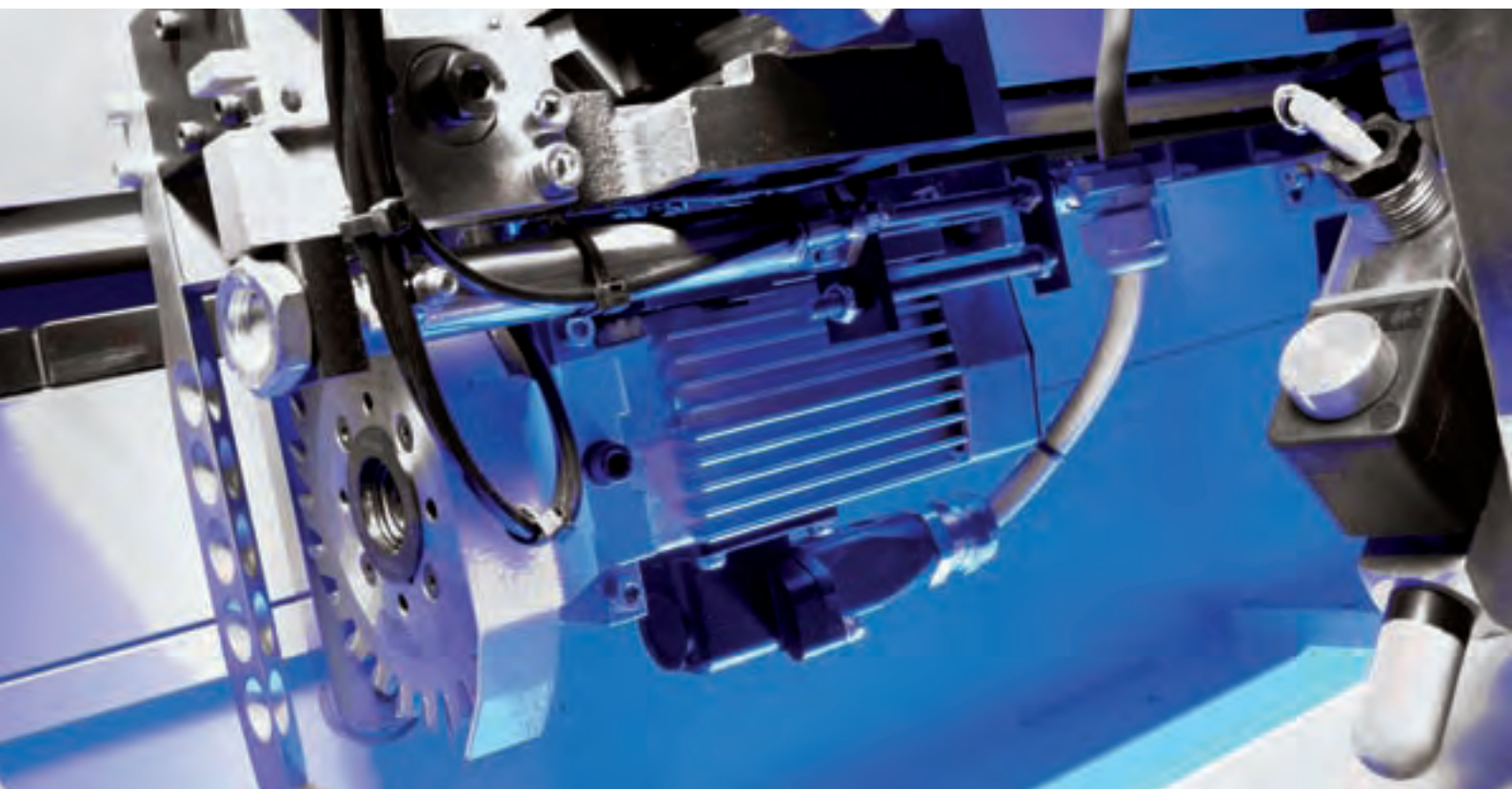

Economy for high aspirations

Perfect edges for discerning customers – manufactured using HOMAG machines

Individual customer needs and preferences, sophisticated products and a wide range of materials – all factors which play a major role in today's woodworking industry. Here, production flexibility and efficiency are key – particularly for woodworking shops and medium-sized enterprises. HOMAG offers unbeatable benefits and has a presence on the ground in over 80 countries around the world. This is the way forward to create a sharp competitive edge and security for your business in the long term.

For us, you and your products are the number one priority. A promise you can count on!





20 mm solid strips



0.6 mm veneer

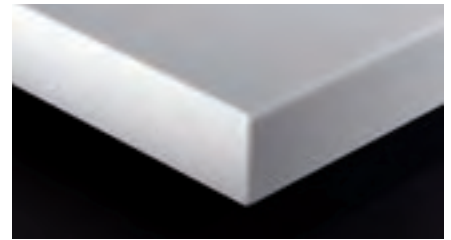

2 mm PVC

For more information, go to:

www.homag.com

www.youtube.com/homaggroup



Contents

- 02 Perfect edges for discerning customers – manufactured using HOMAG machines
- 04 Edition series – all inclusive as standard: The most important features
- 06 Our range of modular units – always up to date
- 07 Units – preparation for top-quality gluing
- 08 Gluing units – reliable hot melt glue application
- 09 **laserTec** – the quantum leap in furniture production
- 10 Snipping units – for perfect preparation
- 11 Four-motor profile trimming unit – takes anything easily in its stride
- 12 Profile trimming – for rounded edges
- 13 Finish – all’s well that ends well
- 14 Additional equipment
- 16 Automation packages
- 18 To ensure simple operation and control we have invested the time that you don’t have
- 20 You invest, we reduce: Life cycle cost management
- 22 Edition technical data

Edition series – all inclusive as standard: The most important features of the models

A uniform, practically oriented equipment standard has been created for the Edition series: Belt-type top pressure beam guide made of steel for precise workpiece guidance, all tools with I-system for optimum chip disposal and processing quality, variable feed rate of 18–25 m/min. for high productivity. Even in the basic version, the machines cover more than 90% of all applications. All the machines of the Edition series offer scope for automation, are energy-saving and environmentally friendly.

Edition 2270 edge banding machine

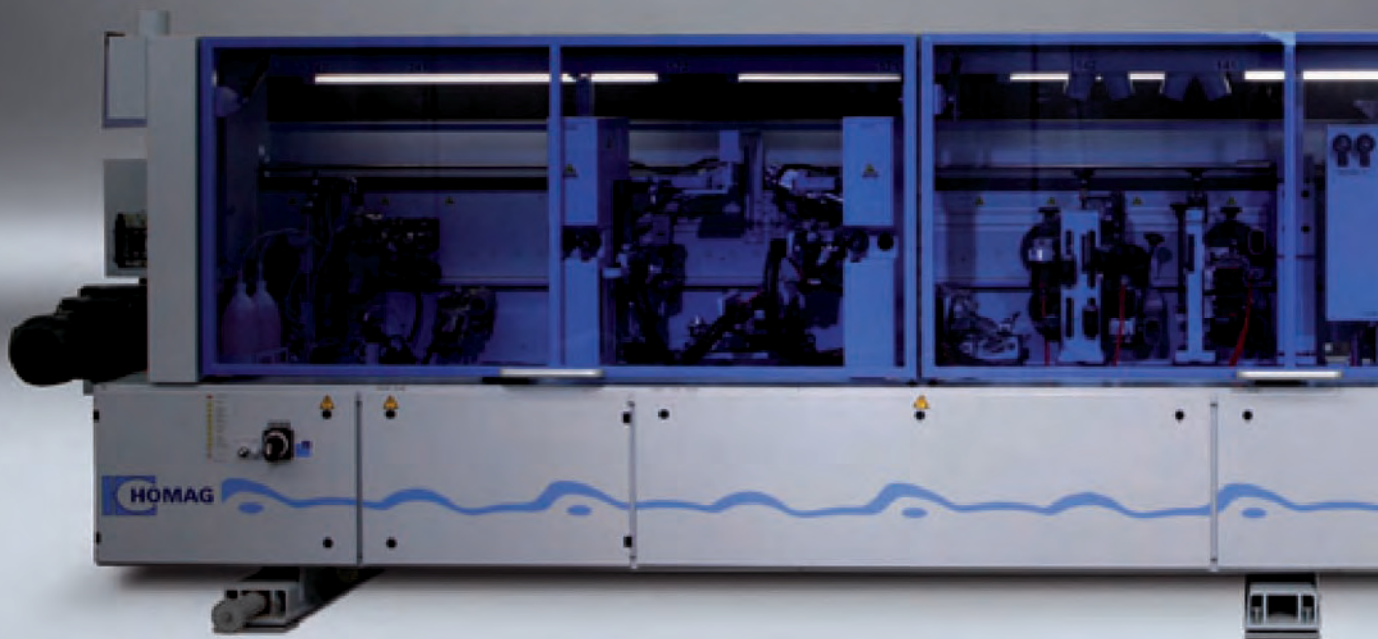

The Edition models

Edition 2262

With two-motor profile trimming:
Edge banding up to 0.4 mm,
strips up to 6 mm.

Edition 2264

Simple change of the hot-melt
gluing unit using quick-release
clamping system for fast colour
change.

Edition 2270

With four-motor profile trimming
for splinter-free trimming of
veneers.

Edition 2272

Profile trimming unit with
automatic 8-slot tool changer.

Edition 2274

With two-motor profile trimming
and free space for universal
trimming unit.

Your benefit

- Optimum edge quality
- Enormous flexibility through capacity to process all types of material
- High level of availability due to durable construction and easy-maintenance machine structure
- Ergonomically arranged control functions
- Low energy requirement
- Minimized extraction requirement
- Outstanding economy
- Optimum cost-to-performance ratio



Our range of modular units – always up to date

A versatile range of different units is necessary to cope with varied processing operations. By continuously extending the offered functions, we ensure that you have the right solution available to cope with changing trends.

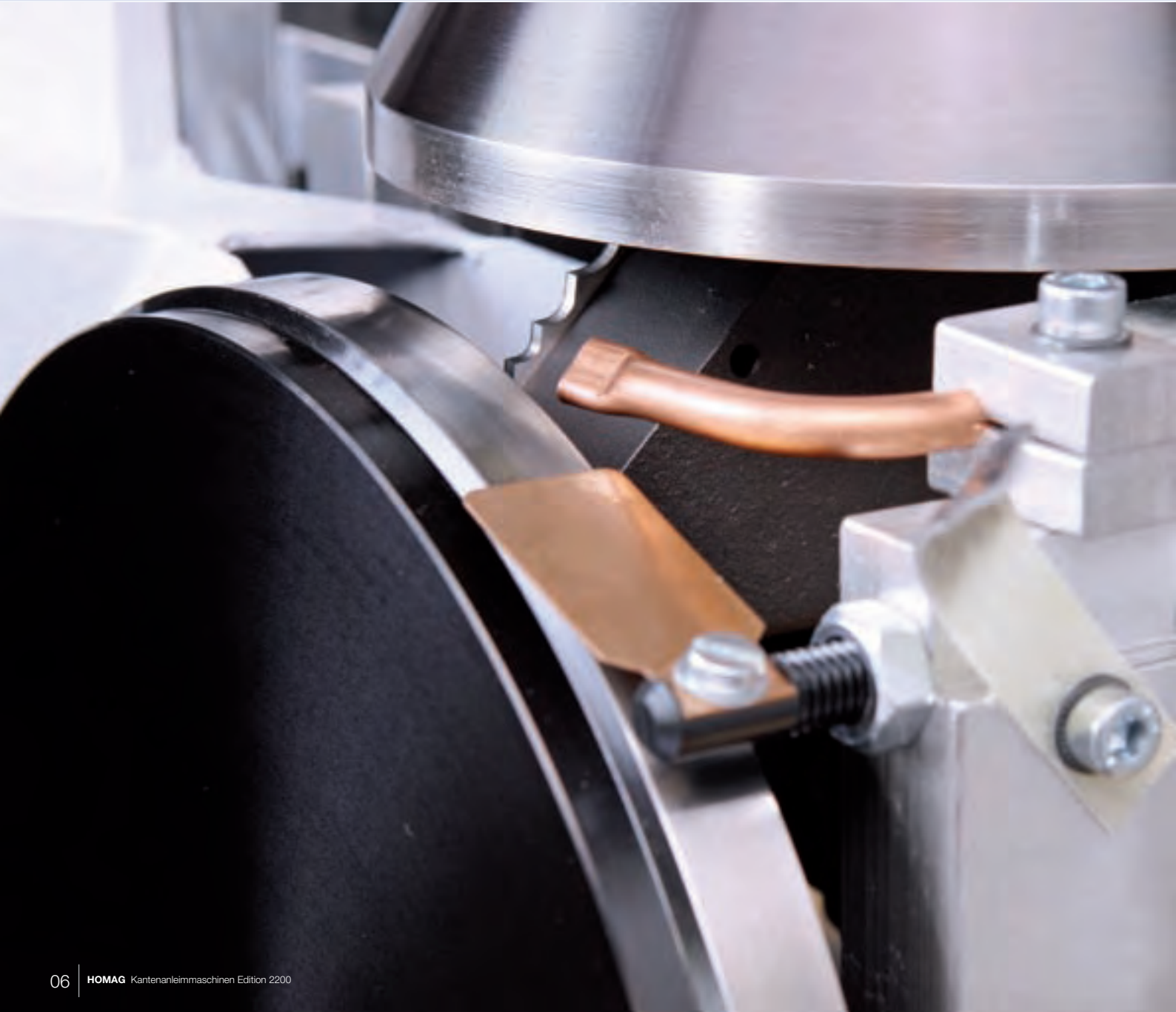

Units – preparation for top-quality gluing

The separating agent spraying unit and the jointing trimming unit ensure optimum preparation of your workpieces for gluing. The spray applied separating agent cuts out laborious finish processing of edges. The jointing trimming unit provides the perfect basis for a consistently high standard of product quality.

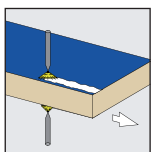
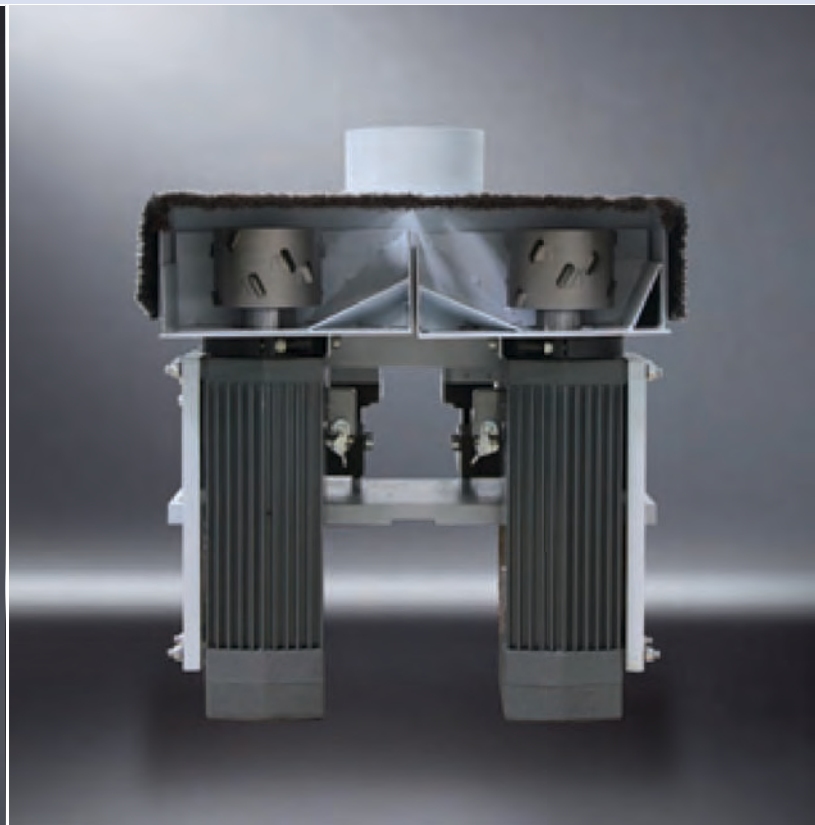

Separating agent spraying unit

Prevents the adhesion of hot melt glue residues on the top and bottom of workpieces, so creating optimum workpiece quality.

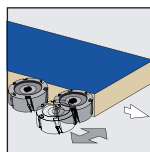

Jointing trimming

This unit permits a high level of processing precision, is extremely hardwearing and is also designed to ensure an above-average service life. The tool diameter is 100 mm.

Gluing units – reliable hot melt glue application

HOMAG gluing units are ideal for a fast, positive connection. The standard gluing unit uses the pre melt system. The heated glue roller ensures an optimum gluing temperature, while magazine height adjustment offers scope for processing wide-ranging different workpiece heights. A simple, toolless quick changeover of the application unit allows other hot melt glue colours to be deployed with a minimum delay.

Hot-melt gluing unit A6

For processing coil material from 0.3–3 mm and solid timber strips of up to 6 mm.

Hot-melt gluing unit A20

For processing coil material from 0.3–3 mm and solid timber strips of up to 20 mm.

Servo edge feed

Edge feed with a precision of +/- 2–3 mm at the leading and trailing edge.

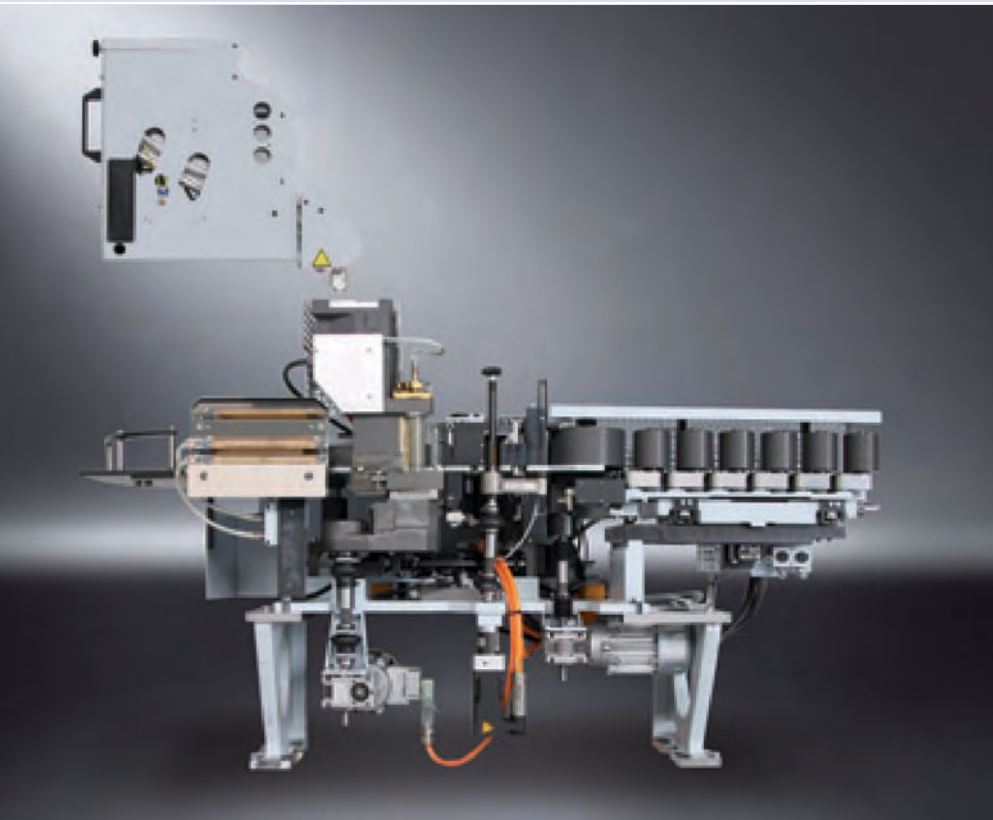

Previous gluing technique



Dimensions in mm

Optimized gluing technique with servo edge feed

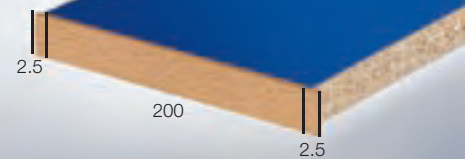

Dimensions in mm

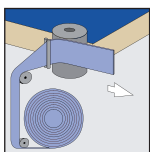

Quick-release clamping system for application unit (option)

For fast changeover of hot melt glue colours. This prevents mix-up of different hot melt glue colours.

laserTec – the quantum leap in furniture production

Edge banding to a previously unattainable standard of quality: HOMAG laserTec is the name of the new production method which has brought a radical transformation to the world of furniture production. It entails melting the surface to be glued using a laser beam and then pressing it directly onto the workpiece. The result: Edges complying to the highest conceivable standard of quality. laserTec can be retrofitted on Edition machines at any time.

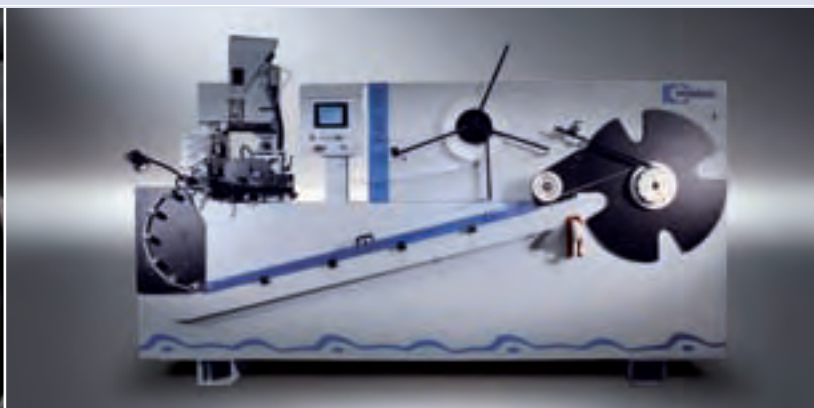
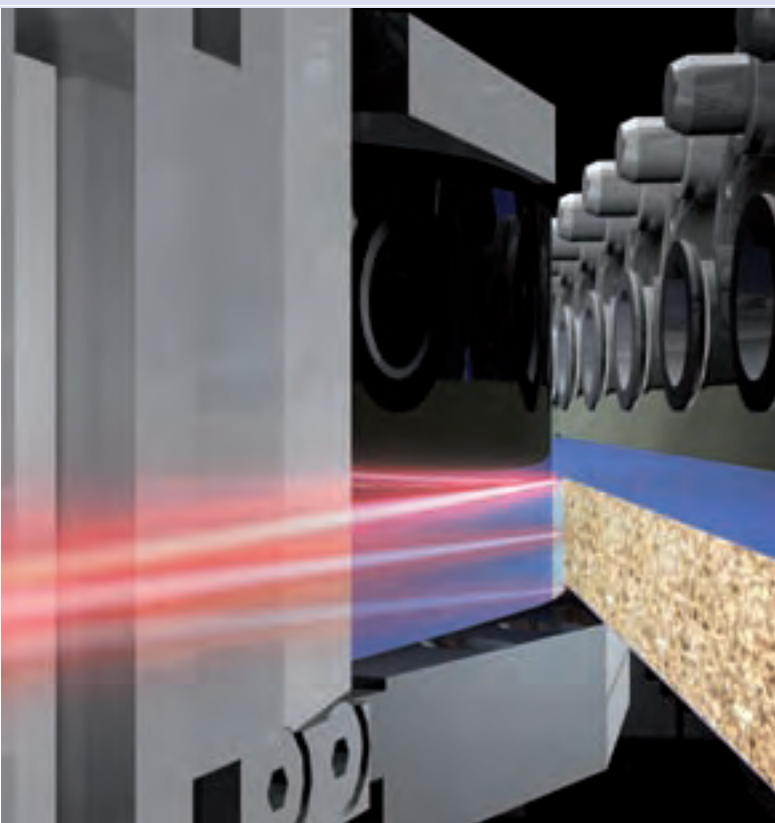

For the entire laser edge spectrum

HOMAG laserTec can be used to process all customary types of edging such as PVC, ABS, PP, PMMA, wood veneer or melamine. The laser-active layer is individually adjusted in line with product and customer requirements.

Optimum economy due to

- Reduced rejects quota
- Simple operating processes
- Low ancillary costs
- Maximum availability
- Reproducible production parameters
- Resource-saving production
- Extreme production reliability

Gain in flexibility

The KBE 100 edge precoating machine prepares conventional edge bands for processing with laserTec. For this, coils of the required edge decor are unwound in the KBE 100, coated with special adhesive, dried / cooled and rewound. This means that edge banding material in the required decor finish is available immediately for processing with the laserTec system. This helps furniture producers remain independent and flexible.

Snipping units – for perfect preparation

The snipping units prepare the workpieces perfectly for the subsequent trimming operation. The face side can be snipped either straight or with chamfer. If the profile trimming unit is used, then a piece of edging material is left in preparation for the optimum trimming result.

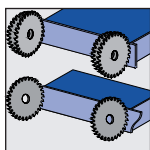

Snipping unit HL81

For a clean snipping cut of overhanging edges on leading and trailing workpiece edges using the drawing cut technique.

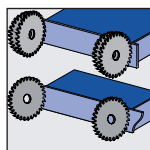

Snipping unit HL84

For snipping the edge overhang at the leading and trailing workpiece edge with stationary snipping stop to protect sensitive workpieces from damage. Drawing snipping cut for optimum snipping saw cutting quality. The minimum gap between workpieces is 400 mm.

Four-motor profile trimming unit – takes anything easily in its stride

The four-motor HOMAG profile trimming unit takes care of corner rounding also when processing veneers. Top and bottom edges can be profiled with copying at the leading trailing edge during transverse processing. The rough trimming unit forms the basis for an optimum processing result.

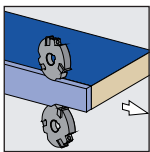
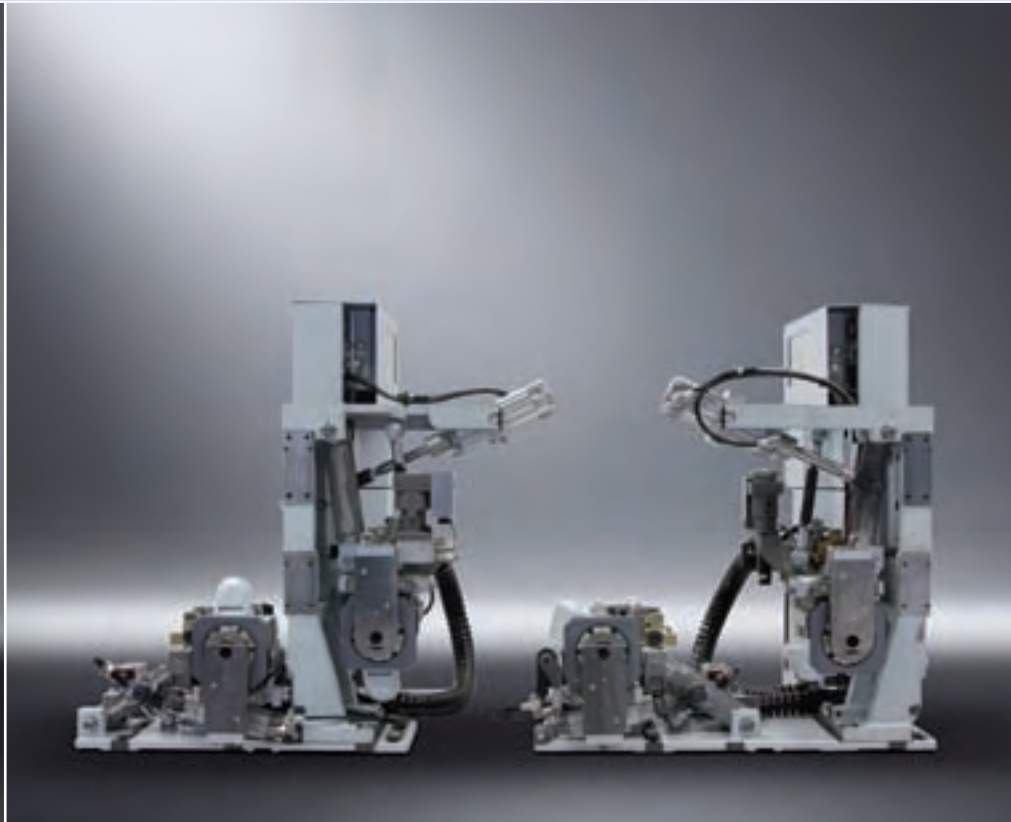
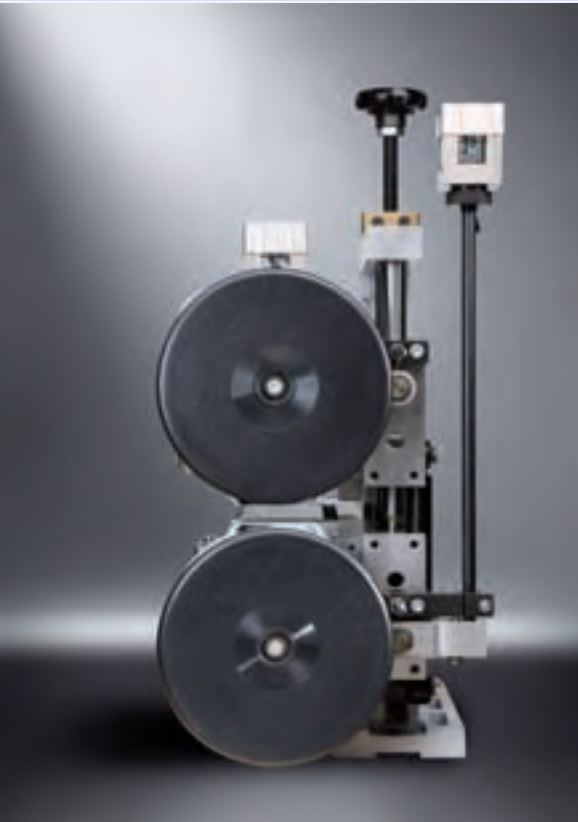

Rough trimming unit 0.55 or 1.5 kW

For rough trimming the upper and lower edge overhang. The unit is equipped exclusively with I tools. This and the HOMAG-patented HSK interface ensure a high standard of processing quality and a long tool life.

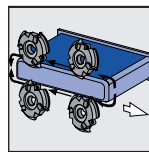

Profile trimming unit FF32

For rounding top and bottom edges on the leading and trailing workpiece edges. By dividing the cut over four motors, each corner can be processed in synchronous rotation, so reducing the risk of splintering even with veneer.

Automation to suit every need

Chamfer/radius adjustment for fast changeover from for instance 0.4 mm to 2 mm edges.

Profile trimming – for rounded edges

HOMAG profile trimming units are universal. As a user, your job is to program any profile that takes your fancy: Then stand back and watch the extreme speed and precision of the expert execution. The efficient mode of operation results in higher productivity. Our dual-motor profile trimming units permit both corner rounding and trimming of upper and lower overhanging edges.

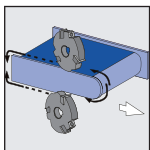
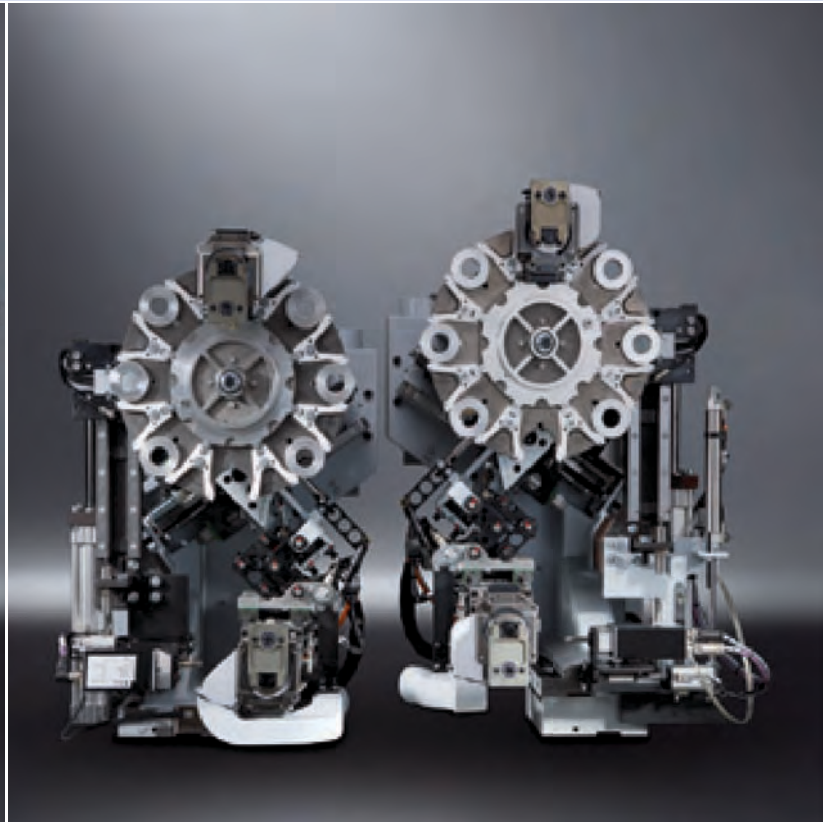

Profile trimming unit FK11

For processing overhanging edges and trimming around the leading and trailing edge.

Automation to suit every need

Chamfer/radius adjustment for fast changeover from for instance 0.4 mm to 2 mm edges.

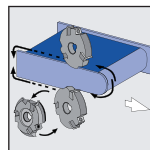

Profile trimming unit FK13

For processing overhanging edges and trimming around the leading and trailing edge. With 8-slot tool changer for automatic changeover to different profiles. The HSK interface ensures the best possible trimming quality.

Finish – all's well that ends well

The quality of your products is increased by the use of perfectly coordinated finishing units. The same principle applies to product as to running a marathon: Those who persevere to the very end will achieve their goal. For a perfect finish which has you running victoriously to the winner's podium instead of tripping over the finishing line, place your trust in HOMAG.

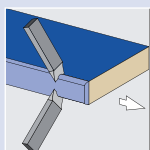

Profile scraper blade PN10

For smoothing trimmed edges to achieve an optimum appearance.

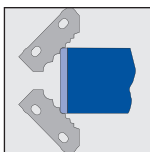
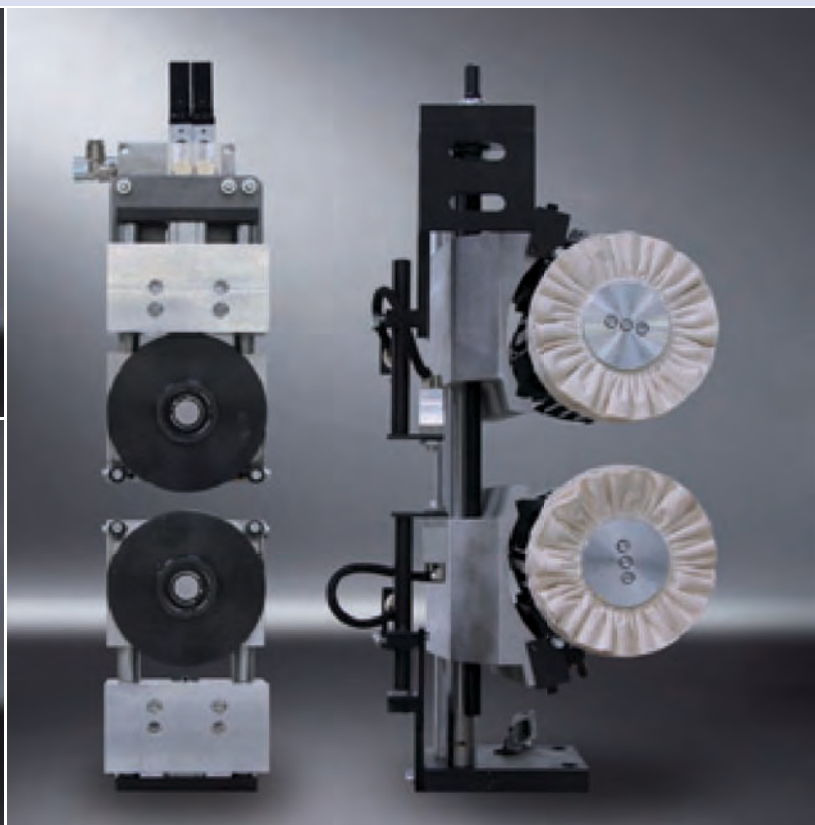
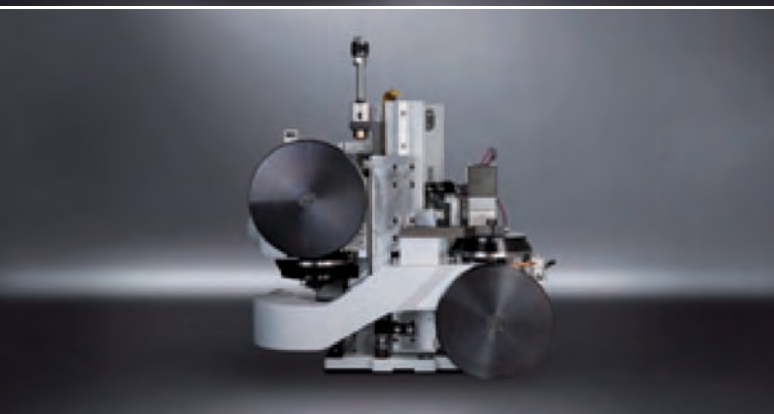

Finish scraping device MN21

For smoothing trimmed edges for an optimum appearance. Optimum resetting for different profiles, corrections to a pinpoint standard of accuracy. Reproducible quality to the highest standard – particularly in conjunction with **laserTec**.

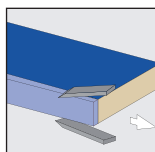

Finish processing

Comprising a glue joint scraper blade for disposal of glue residues at the top and bottom of PVC edges and a buffing unit.

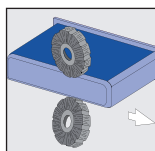

Additional equipment

For every Edition model, we offer ideal supplementary equipment options to upgrade the existing equipment outfit for your specific needs.

Increase of workpiece thickness to 60 mm

By raising the height of the units.
With jointing trimming: I-DIA jointing trimming unit 63 mm.

PU melting unit

For melting 2 kg drums of PU. Melting output 6 kg/h.
No nitrogen gassing required.

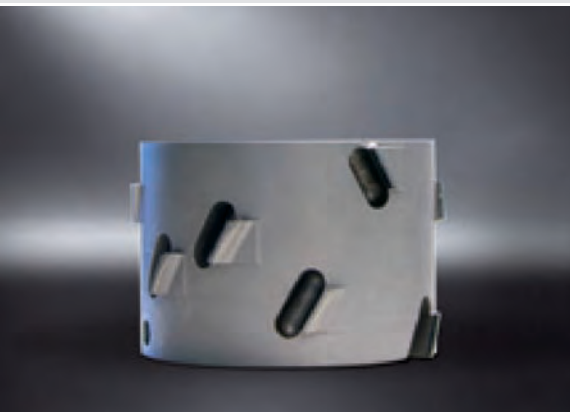
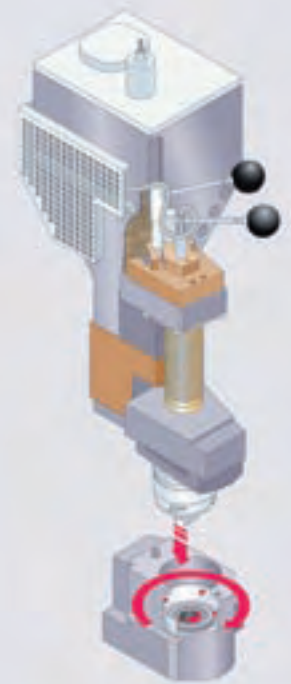
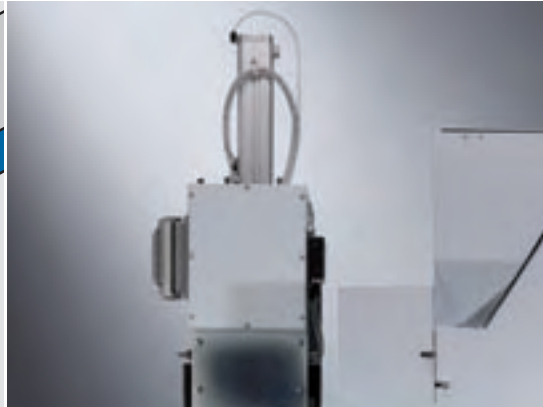
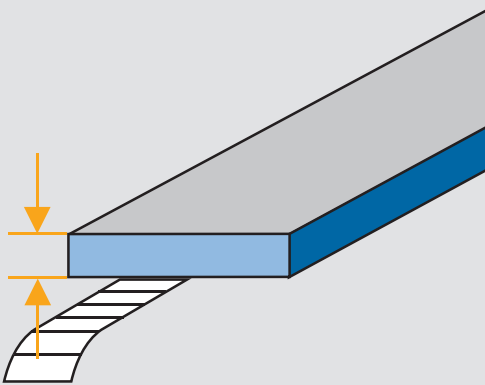

QA glue tank front section for exchanging

For fast exchange between different types of hot melt glue.

QA glue tank front section to be exchanged for PU application

Teflon coated

Quick-release clamping system

Fast toolless exchange of the application unit. Simple exchange, e. g. between different hot-melt glue colours. No separate exchange of tank and glue roller required.

Exchange head set for FK

Fast, precise changeover of the exchange head for FK. Different lateral tracing configurations: Non-adjustable, manually and automatically adjustable.

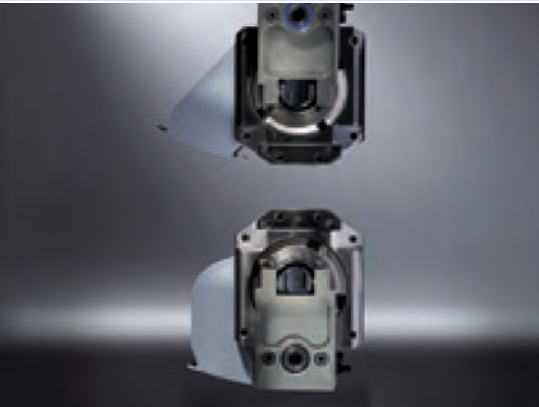

Exchange device FF32

For exchanging the complete assembly (tool with motor and motor retainer) instead of the tool. Configurations: Manually and automatically adjustable.



I-system DIA-radius / chamfer trimming unit

R = 1.5–3 mm, chamfer 15°.

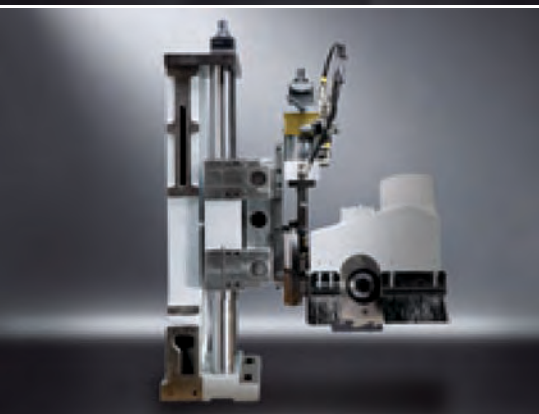

Universal trimming unit UF10

For grooving, rebate trimming and profiling.



Quick-change head set PN10

Fast profile change without adjustment work. Configurations:

- R = 1.5 mm
- R = 2 mm
- R = 2.5 mm
- R = 3 mm



Cleaning agent application

Spray unit for application of cleaning agent to the workpiece above and below. Mounting upstream from the buffing unit.

Automation packages

The Edition 2200 automation packages will help you achieve higher productivity due to substantially faster resetting. All axis adjustment processes are performed by means of servo axes. Adjustment is program controlled for optimum precision and repeat accuracy.

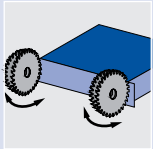

Programmable adjustment of the chamfer/straight snipping motor.

For fast changeover between straight snipping and snipping with chamfer.

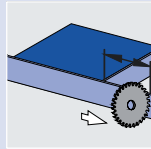

Programmable adjustment of the flush/overhang snipping motor

For fast changeover between flush snipping (e. g. of solid strips or inlay shelves) and snipping with overhang (e. g. for finish trimming with profile trimming unit).

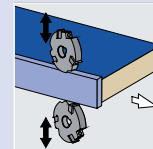

Automatic adjustment of the flush/overhang rough trimming unit

For automatic changeover from flush trimming to trimming with edge overhang.

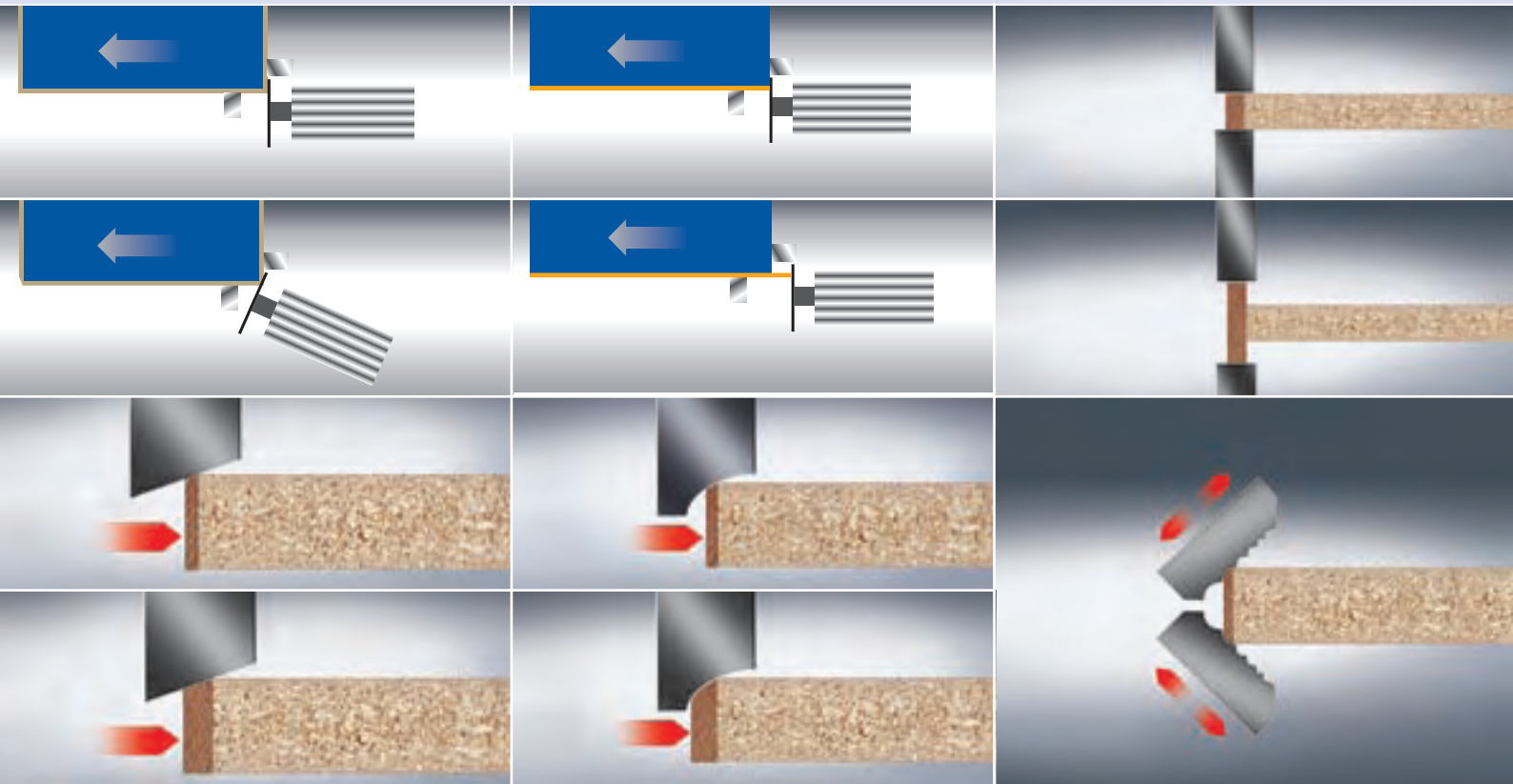

Automatic adjustment to different chamfer thicknesses

- Profile trimming FF32, FK11 and FK13

Automatic adjustment of chamfer and radius

- Profile trimming FF32, FK11 and FK13

Multi scraping blade MN21

Changeover between different profiles, e. g. chamfer 20°, R2 and R3.

- Servo axes for programmed horizontal and vertical adjustment
- Workpiece scanning from above or the side for precise edge profiling

Automatic adjustment of the infeed fence and pressure zone

Program controlled adjustment of servo axes for optimum precision and repeat accuracy.

Remote control

This allows the feed system to be started while the operator is standing by the unit during setting work.

Electronic height adjustment

Programmed automatic height adjustment of the top pressure beam on a change of workpiece thickness.

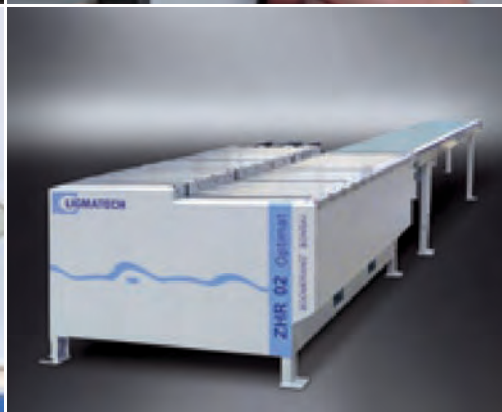
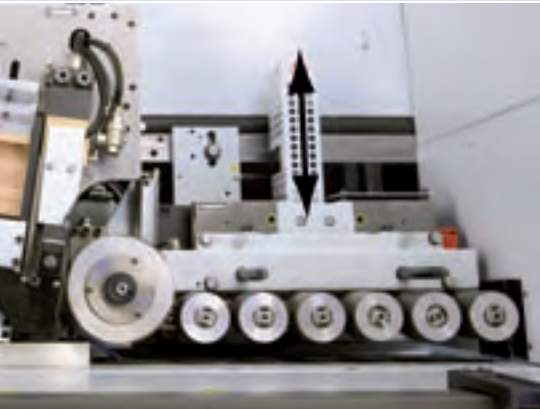

Pneumatic adjustment for PN10/finish processing unit

Automatic cut-in and cut-out from the work area.

Pre-installation of the LIGMATECH return conveyor

Boomerang return conveyor for the models: ZHR 01, ZHR 02, ZHR 05.

Increased cooling output > 40° C

To protect the electronic system at ambient temperatures of over 40° C. Ensures reliable, trouble-free production even in extreme climate conditions.

To ensure simple operation and control, we have invested the time that you don't have

You cannot afford to spend weeks trawling through the operating instructions to ensure optimum machine utilization. This is why we design HOMAG machines to make simple operation and reliable control a matter of course. In the HOMAG Edition series, for instance, manual intervention in the machine's control system has been reduced to a minimum.

For more information, go to:

www.homag.com/software

Standard



Everything in hand with powerControl PC22

This modern, highly flexible control system offers a range of additional functions for the simple, reliable operation of your machine:

- User-friendly menu prompting using the Windows-XP standard
- Large 17" display affords a clear overview of all machine functions
- Easily understandable plain text messages in the local language

These benefits combine to ensure a production-ready machine as and when you need it.

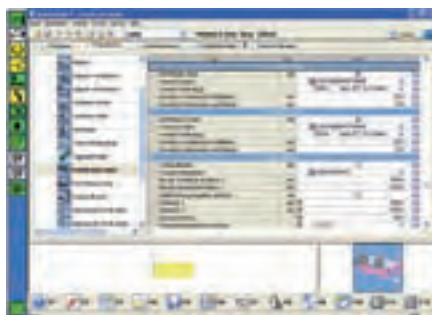

Programming with woodCommander

The programming system for all HOMAG throughfeed machines. Extreme user convenience due to input screens with graphic support – for simple navigation and menu prompting. Keeping your machine up and running and ready for production.

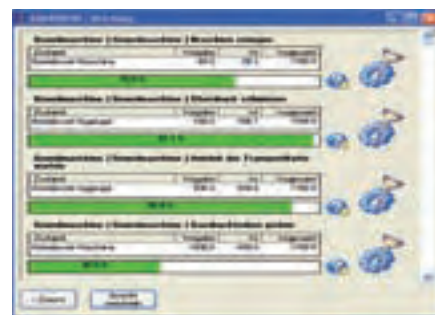

Evaluation with Schuler MDA Basic

The acquisition of piece numbers and actual operational times at the machine provides meaningful information about your machine's productivity. Integrated prompting ensures timely execution of necessary maintenance work in keeping with the maintenance schedule.



Simple, intuitive operation by means of touch screen

Touching the display allows the operator to select all the important functions for fast, reliable production. Program selection, selection of edges and changing the workpiece height are just some of the possibilities afforded by this innovative operating concept.



Standard



USB port

Data input and data safety using external USB storage facilities ensure simple data handling and provide the assurance of a production-ready machine.

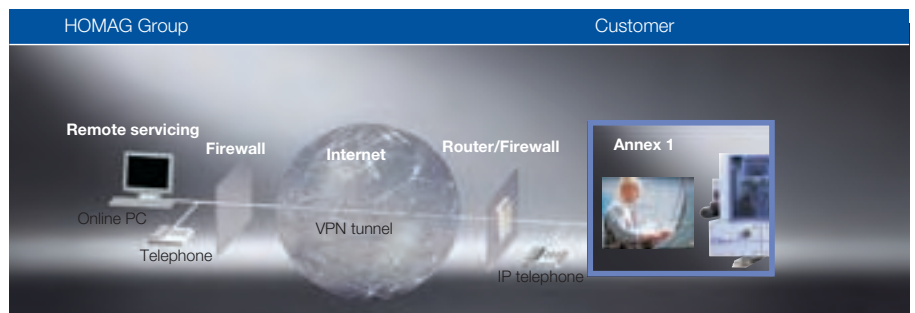

TeleServiceNet

Selective fault analysis and diagnostics using Internet technology offer scope for rapid service and assistance. With a single connection, any machine can be accessed – right down to the last link in the control chain.

Option



Diagnostic system woodScout

High-performance diagnostic system which as well as providing plain text messages also offers an indication of the fault location at the machine. The facility for saving remedial actions in the woodScout memory permits you to continuously extend the expert knowledge supplied with the diagnostic system.

You invest, we reduce: Life cycle cost management

It is not the investment costs which decide the economic success of your production, but the capacity utilization and unit costs. This is why our primary objective is to combine top class production with higher productivity and consequently lower unit costs. With the new ecoPlus technology package from the HOMAG Group, you will also be helping to conserve precious energy, time, material and personnel resources.

For more information, go to:

www.homag.com/services



Unit cost reduction through

Optimum financing

- HOMAG Finance offers optimized financing concepts based on individual business administration requirements
- The outstanding value stability of HOMAG machines offers benefits in terms of leasing and subsequent replacement investment

High level of processing quality “without” finish processing

- Perfectly coordinated machine configuration

Practically oriented training

- Selective and targeted training will help you quickly achieve full productivity
- Your employees will be prepared for safe, efficient HOMAG machine operation

Reduced unit labour costs

- Fast, simple operating capability of machines
- Simple resetting processes

High degree of machine availability

- Worldwide servicing minimizes downtime
- TeleServiceNet – our “eye” into the machine avoids costly on-side services
- woodScout diagnostic software – intelligent self-help for all machine operators

Fast achievement of productivity

- To get you quickly up to your targeted high shift output, our employees will visit your company to ease you into the start of production. This will take you faster to your targeted production output

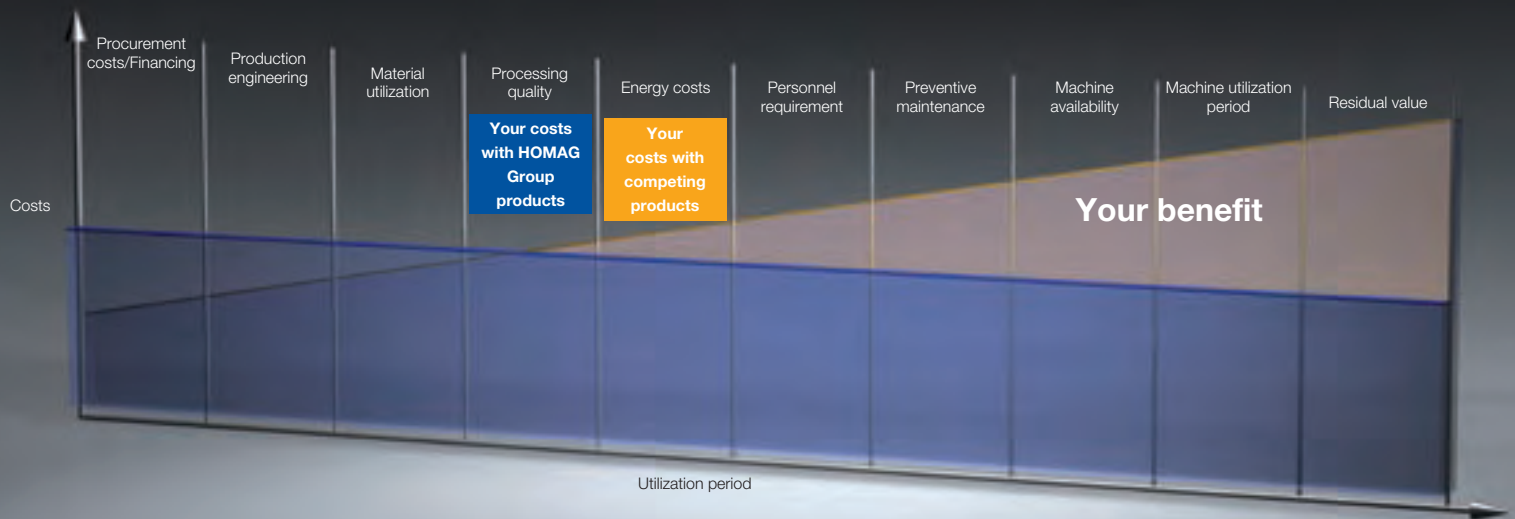

Preventive maintenance

- MDA software provides the machine operator with an indication of required maintenance
- Regular inspections and preventive maintenance help avoid faults and prolong the service life
- The worldwide HOMAG servicing network with over 500 technicians provides support when you need it

Machine utilization period

- Continuous expansion of functionality ensures compliance of the machines with the requirements of tomorrow
- The HOMAG conversion department offers solutions to address major conversion requirements, ensuring a high degree of investment security over years

Minimal energy costs with ecoPlus*

- Intelligent stand-by operation reduces energy costs during break periods by up to 90 %.
- A valve control system switches the extraction on only for units which are actually operational. This reduces extraction costs by up to 20 %
- I-tools reduce the extraction speed. Current consumption per machine is reduced in this way by around 1 250 kWh. This does not take into account savings due to room air which requires no extraction (heating / air conditioning)
- The PC22 control switch cabinet is cooled using cool plate technology. This passive cooling system requires no energy. No filters require changing and maintenance costs are saved. The system also remains closed. No dust is able to penetrate
- All drive systems comply with energy efficiency category IE2
- Optional measurement and visualization of current consumption data from compressed air extraction and flow to optimization of overall energy consumption

Material savings with ecoPlus

Servo edge feed systems cut material consumption by reducing the edging used per workpiece.



For more information, please request our **ecoPlus** brochure.

* Depending on equipment configuration, service period and workpiece spectrum.

Edition technical data

Edition 2262

	Solid strips (mm)	Coils (mm)	Strips (mm)
a	with b = 22: min. 60 with b = 40: min. 105		
b	12 (opt. 8) / 40 (opt. 60)		
c	0.6-6	0.3-3.0	0.3-3.0
d	45 (optionally 65)		

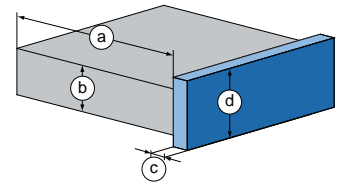
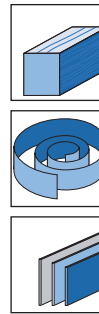

Edition 2264

	Solid strips (mm)	Coils (mm)	Strips (mm)
a	with b = 22: min. 60 with b = 40: min. 105		
b	12 (opt. 8) / 40 (opt. 60)		
c	0.6-20	0.3-3.0	0.3-3.0
d	45 (optionally 65)		

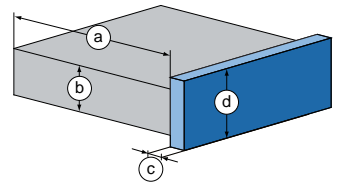
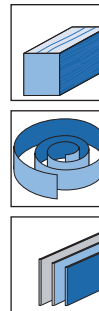

Edition 2270

	Solid strips (mm)	Coils (mm)	Strips (mm)
a	with b = 22: min. 60 with b = 40: min. 105		
b	12 (opt. 8) / 40 (opt. 60)		
c	0.6-20	0.3-3.0	0.3-3.0
d	45 (optionally 65)		
e	max. 25		

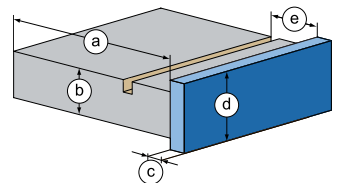
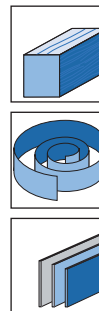

Edition 2272

	Solid strips (mm)	Coils (mm)	Strips (mm)
a	with b = 22: min. 60 with b = 40: min. 105		
b	12 (opt. 8) / 40 (opt. 60)		
c	0.6-20	0.3-3.0	0.3-3.0
d	45 (optionally 65)		

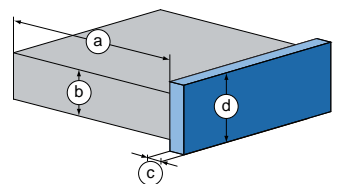
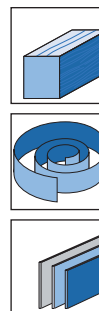

Edition 2274

	Solid strips (mm)	Coils (mm)	Strips (mm)
a	with b = 22: min. 60 with b = 40: min. 105		
b	12 (opt. 8) / 40 (opt. 60)		
c	0.6-20	0.3-3.0	0.3-3.0
d	45 (optionally 65)		
e	max. 25		

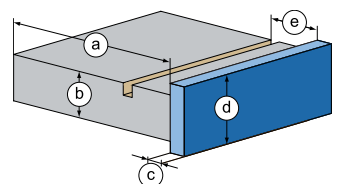
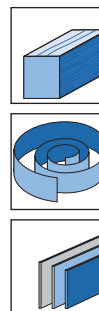

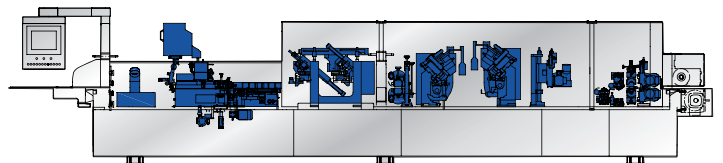
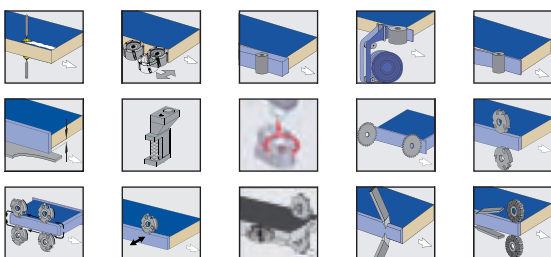
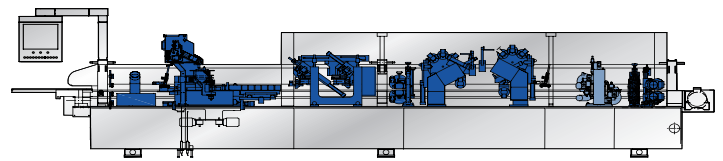
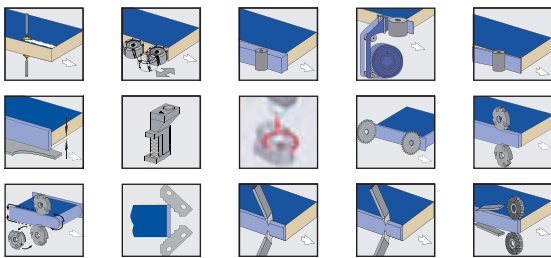
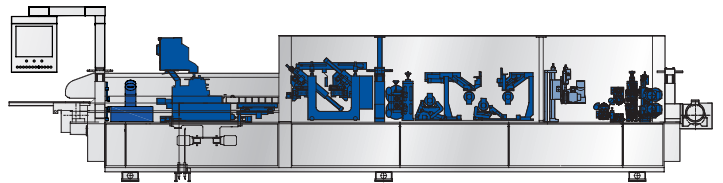
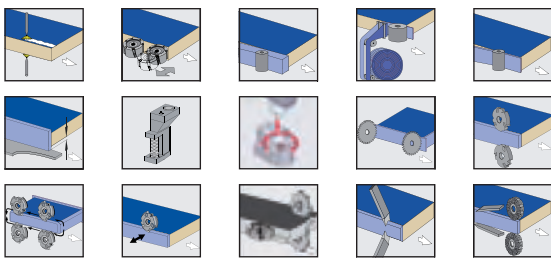
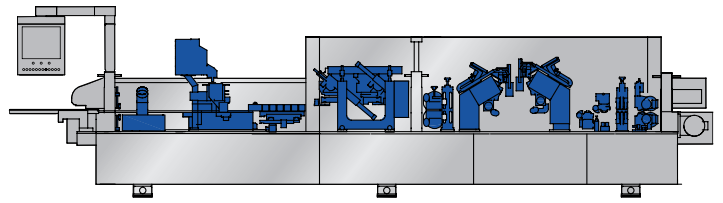
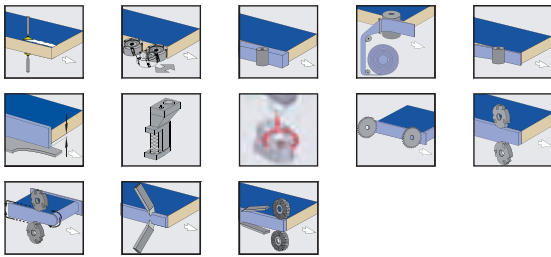
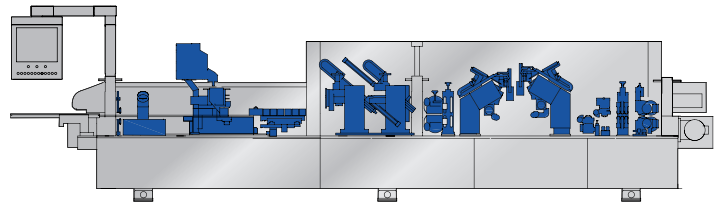
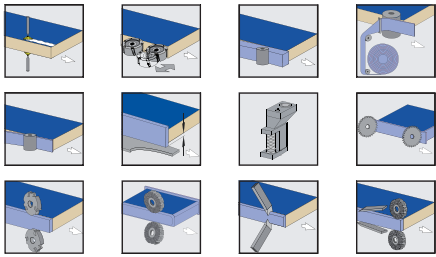

	Edition 2262	Edition 2264	Edition 2270	Edition 2272	Edition 2274
	Machine dimensions				
Overall length [mm]	7 755	7 755	8 545	8 545	8 635
Overall width closed/open [mm]	910/1 540				
Overall height closed/open [mm]	1 820/2 250				
Working height [mm]	950				
	Working dimensions				
Workpiece width [mm] with workpiece thickness 12–22 mm	min. 60 Dependent on workpiece length				
Workpiece width [mm] with workpiece thickness 23–40 mm	min. 105 Dependent on workpiece length				
Workpiece thickness [mm]	min. 12–40 (opt. 8–60)				
Edge thickness, coils [mm]	0.3–3				
Edge thickness, strips [mm]	0.4–6	0.4–20			
Workpiece overhang fixed [mm]	30				
Edge cross-section [mm]	max. 3.0 x 45/1.0 x 65				
	Miscellaneous				
Adjustable feed - m/min.	18–25				
Connected load kW	28	28	33	30	33
Extraction connection dia. [mm]	80/100/120				
Total suction output appr. m³/h	5 250	5 250	7 040	4 310	4 860
Total suction output appr. m³/h without uni-trimming			6 250		4 070
Pressure loss appr. Pa	2 500				
Compressed air consumption appr. NI/min.	930	930	825	855	870
Electrics	400 V - 3 Ph - 50 Hz				
Pneumatic system bar	7				

Content, technical data and photos are not binding in every detail.
We reserve the right to make changes.

The economical way to produce perfect edges

The Edition models are preconfigured with different units for economical, optimum quality production. The performance and functional scope of this machine series have been tailored to the needs of woodworking shops and medium-sized producers. The basic version of the machines covers a wide range of different applications. As well as offering scope for automation, they are trimmed for environmentally friendly operation with ecoPlus.

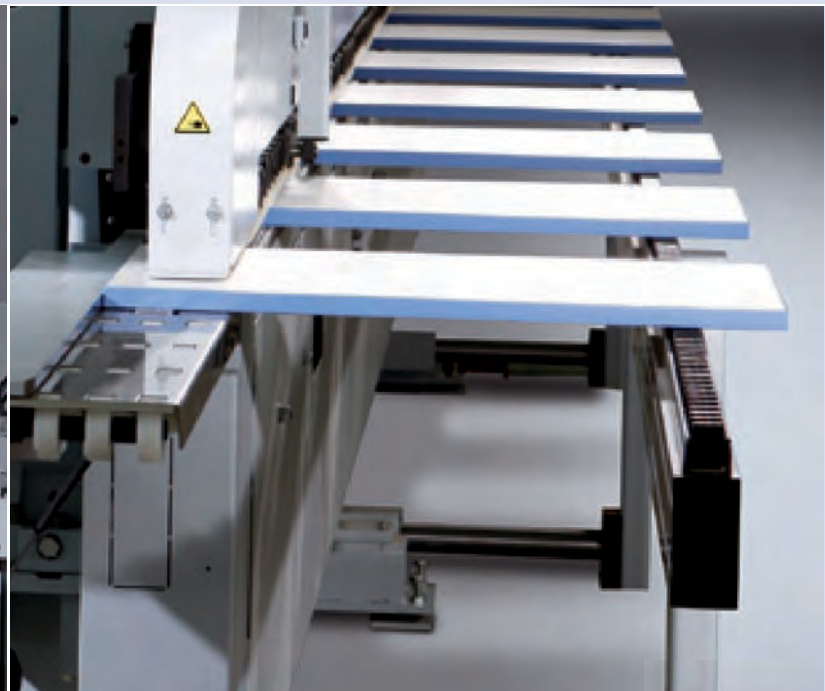



Choose the Original Choose Success!

For the Success of Original Technology
A VDMA campaign



HOMAG Holzbearbeitungssysteme GmbH

Homagstraße 3-5
72296 SCHOPFLOCH
GERMANY

Tel. +49 7443 13-0
Fax +49 7443 13-2300
info@homag.de
www.homag.com