

K 600 Edge Banding Machines



Pure precision

So you think there is room for even more improvement? Welcome to HOMAG!

In today's world, good is simply no longer good enough. Only by delivering absolute premium quality can you be sure of staying out in front of your competitors. A furniture panel tells its own story about how and on which machine it was produced. The edge progression and joint quality must be just right every time - and by investing in plants and machines from HOMAG means you know they will be. High-performance machines from HOMAG guarantee optimum efficiency. Exceptional availability and a consistently high standard of quality mean superb products for the ultimate in customer satisfaction.



The HOMAG Group success through partnership!

“As our customer, you and your products are our number one priority”. HOMAG Group customers have been able to rely on this pledge for over 50 years the world over. We are present in over 80 countries with a close-meshed network of sales companies and partners.

Let the comprehensive expertise of this high-powered group of companies work to secure your business success:

- 50 years of mechanical engineering experience
- Driving force for innovation
- Production “Made-in-Germany”
- Highly qualified workforce
- Excellent cost-to-performance ratio
- We supply machines and plants to address your specific needs. Robust, innovative engineering based on perfectly coordinated components. Units can be retrofitted in free spaces at any time. Control systems used in storage and handling systems are also compatible.

Place your trust in the experience of the market leader

Several thousand successfully installed machines and plants have placed HOMAG in a class of its own as the undisputed market leader. HOMAG technology makes for lower unit costs, ensuring a rapid return on investment.

“Your requirement - our experience - a joint solution”



K 600 – a machine to place you firmly in the Champions League

The machine equipment, the processing unit configuration - every aspect of the K 600 offers the ultimate in terms of freedom, performance and flexibility. After all, it was designed with the highest production category in mind.

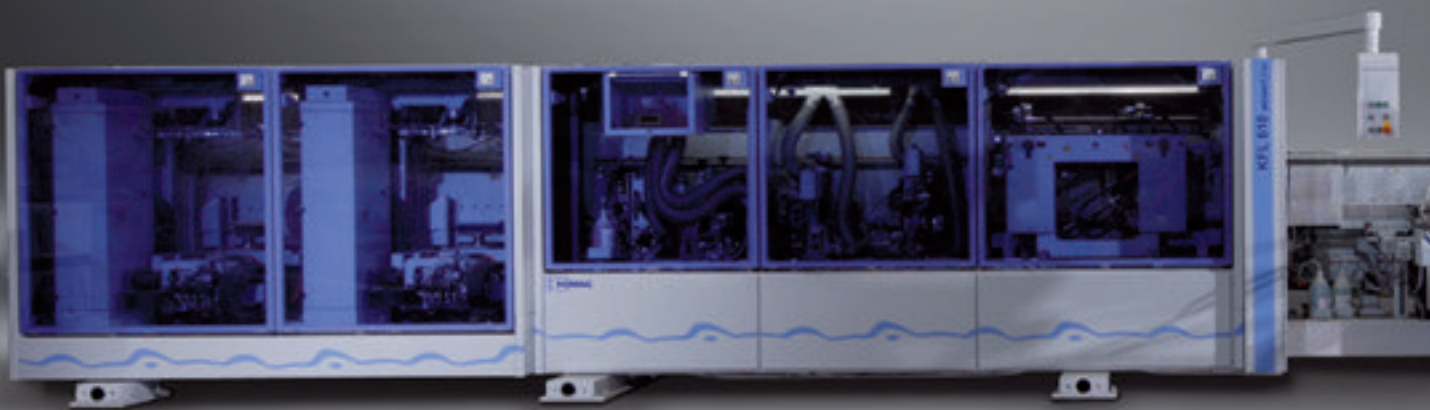



U line featuring K 610 and K 624



The secret behind precision edges: Team work

HOMAG Series K 600 edge banding machines offer flexibility, durability and excellent availability. They can be used for instance to profile, rebate or groove panel-shaped workpieces such as chipboard, MDF, coreboard, solid wood and plastics. And it goes without saying that workpieces can be edged using hot-melt, PU adhesive or laserTec with any kind of popular edging material: natural or plastic, coils or fixed length material. Choose between a KAL 600, which processes pre-sized workpieces in unfinished fixed dimensions or the KFL 600, which is capable of component sizing, edging and finish processing.

Scope of application for the K 600

	610	614	620	624
Single-sided	X	X		X
Double-sided			X	
Small batch sizes	X	X		X
Large batch sizes			X	
Carcase		X	X	X
Fronts	X		X	X

Single-sided machines type 610: Width-independent and flexible

The gold standard for just-in-time production. An edge is banded onto the relevant workpiece side with each machine pass. Because these machines work independently of width, they offer extreme flexibility of application. Using workpiece infeed systems, they are capable of achieving high capacity levels both with pre-sized and unsized workpieces.

Double-sided machines type 620: Series furniture production

The classical application for double-sided machines and machine lines: Large-scale series production. These machines are distinguished by extreme high output where minimal resetting processes are involved. At the same time, they offer almost unlimited scope for equipment.



Batch size 1 with model 614/624: Flexibility plus performance

Ideal for just-in-time production with maximum output. Workpiece guidance along the cam ledges ensures a high standard of precision even with extreme part dimensions. This allows the 614/624 machines to combine flexibility and performance with high-quality angular precision.

Workpieces and edges: Versatility is the key

HOMAG machines do it all: They are capable of sizing, profiling, edging, processing, rebating and grooving a wide range of different workpieces. These include chipboard, MDF, coreboard panels, solid wood, plastics and many more. Just as flexible: Edge banding. Using hot-melt, PU adhesive or laserTec, solid wood, melamine, PVC, ABS or veneer edges can be applied in coil or fixed length material form.

Machines from HOMAG: Innovative technology, intuitive operation

- PC control from HOMAG
- Maintenance-free flat guides on the machine base
- Fast width adjustment due to linear guidance and recirculating ball screw technology
- Reliable program-controlled automatic height adjustment of the top pressure beam
- High degree of dimensional and repeat accuracy due to precision drive systems
- Optimized chip and waste piece disposal



20 mm solid moulding



Veneer

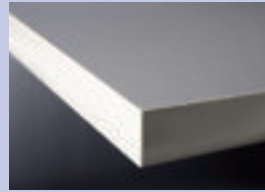

0.4 mm melamine



2 mm PVC

The production of premium quality furniture demands premium-quality machines.
Machines of the calibre made by HOMAG.



The HOMAG K 600 series – as variable as your production needs

When it comes to processing your workpieces, flexibility is what counts. Which is why the machines of the HOMAG K 600 series are adjusted precisely to the varying widths of your workpieces. Chose from a wide selection of working widths from 1,000 to 3,500 mm in steps of 500 mm, with facility for reducing the minimum working width to 210 mm. If you are processing wide workpieces, we recommend using an additional central support.

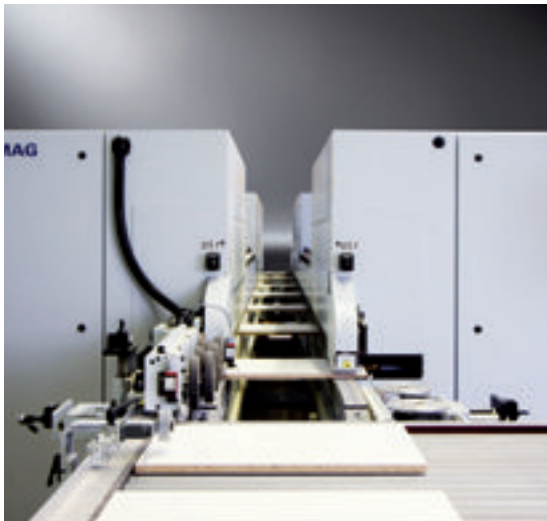

Longitudinal processing with the KFL 620

Safe stop: The workpieces are guided into the machine along the infeed fence, after which they can be cut precisely to size.



Transverse processing with the KFL 620

The steplessly adjustable cams of the transport chain form the workpiece stop. This allows even softforming parts or profiled components to be reliably transported through the machine without damage.

Flexible longitudinal and transverse processing with workpiece infeed systems

This concept of multi-sided processing in consecutive passes permits the achievement of high capacity levels even for just-in-time production with continuously changing dimensions.

High-speed unit resetting within a minimal gap between two workpieces is the state of the art.

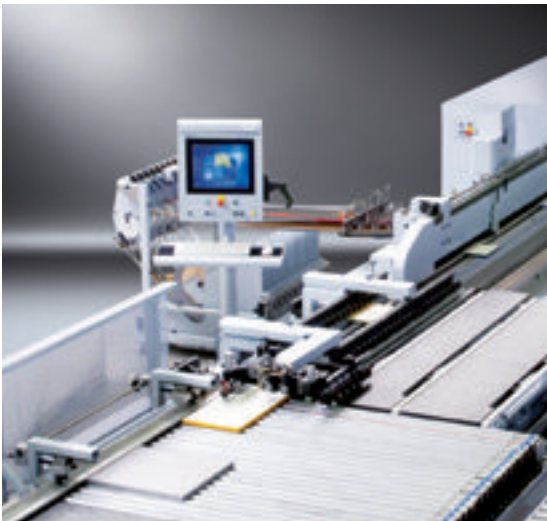

The solution for precisely angular workpieces: Workpiece infeed WZ10

For workpieces which have already been cut to a high level of angular and parallel accuracy with their unfinished fixed measurement, we recommend using workpiece infeed WZ10. This is configured specifically for transporting pre-sized workpieces for flexible production.



Workpiece infeed system WZ14

A parallel precisely angled cut is not necessary with this workpiece infeed system. The workpieces are fed at a precise angle in the longitudinal and transverse direction. The machine's sizing units then cut the workpiece precisely to size. Cyclical outputs of up to 12 workpieces/min. are possible.



Capable of processing anything: Workpiece infeed system S114

A parallel precisely angled cut is not necessary with this workpiece infeed system. The workpieces are fed at a precise angle in the longitudinal and transverse direction. The machine's sizing units then cut the workpiece precisely to size. Cyclical outputs of up to 30 workpieces/min. are possible.

Efficiency through series production

Production of today's panel furniture is inconceivable without the high-performance K 600 demonstrating the highest process reliability. The K 600 addresses your precise operating requirements reliably every time.

Have your HOMAG K 600 tailored to fit you – the same way you would a suit

At HOMAG, production lines are specifically designed, installed and commissioned for you by your own personal team.

This allows us to guarantee a top class solution to your specific production assignment. Because networking individual processing machines and material flow systems is a complex task – one we tackle by putting together a specially configured HOMAG project team: your HOMAG team.

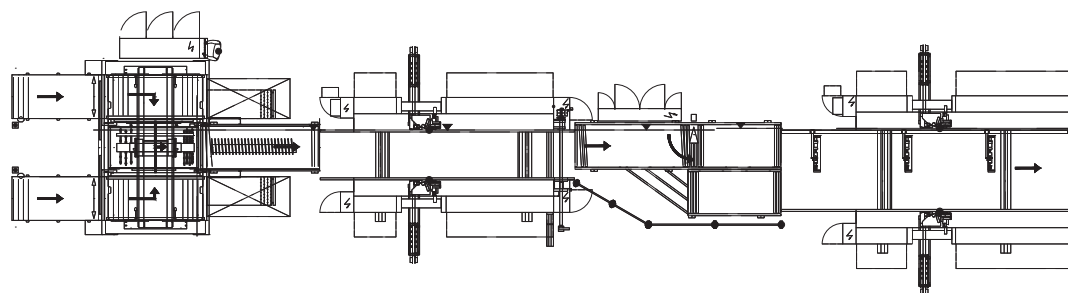
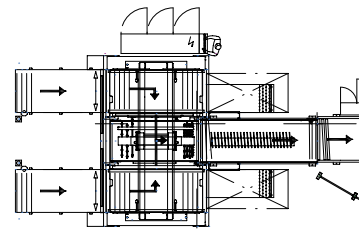

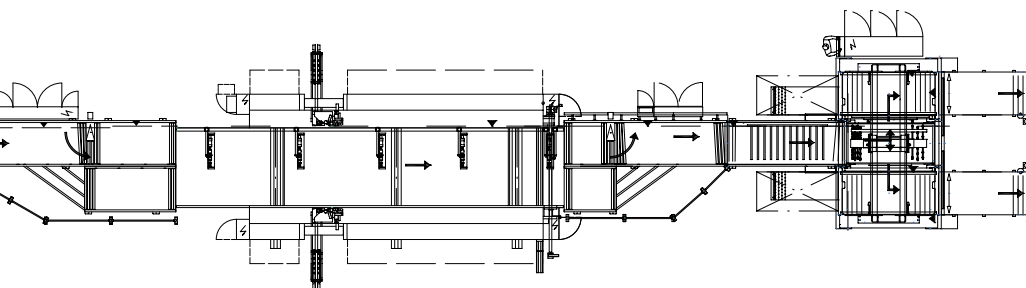
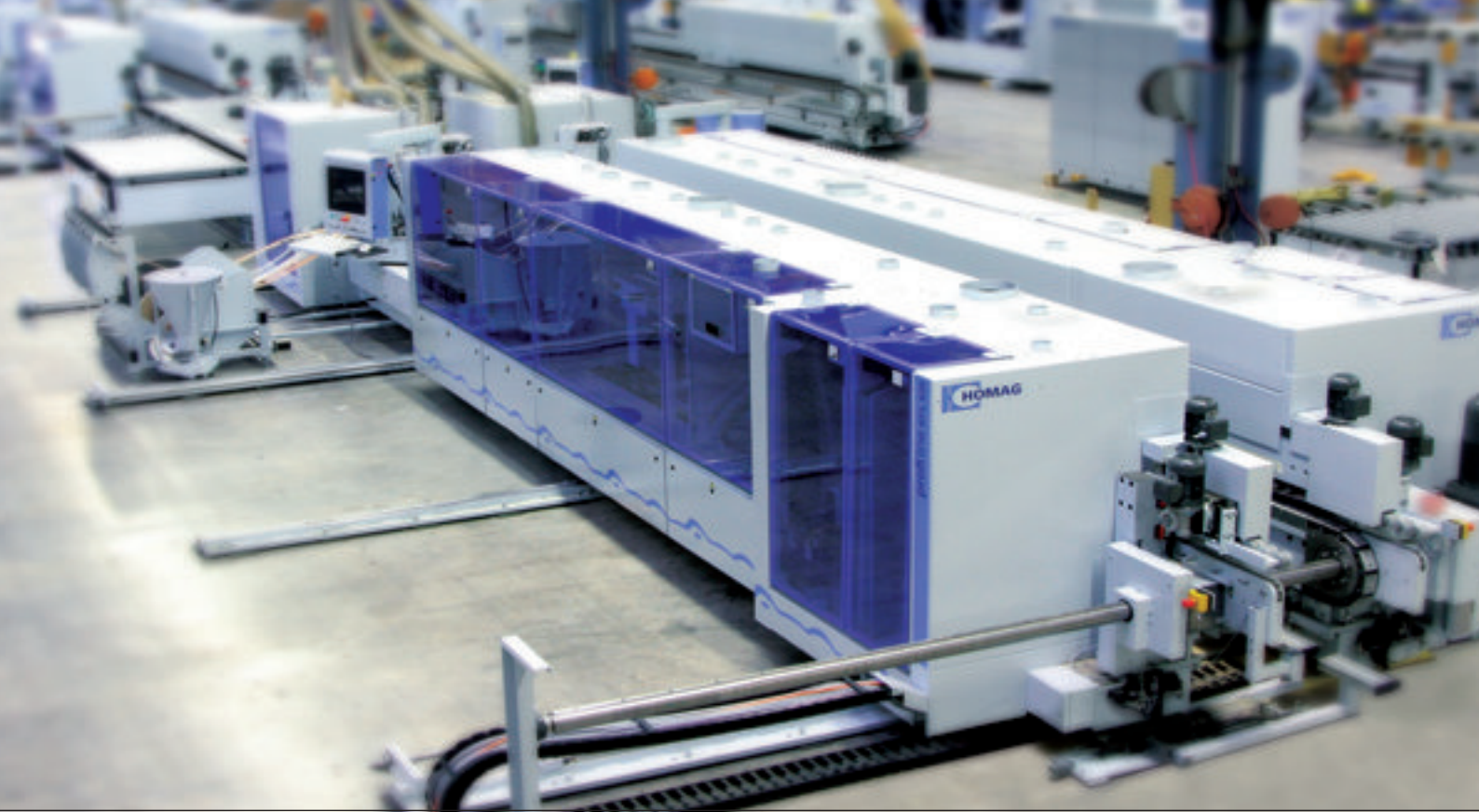

1) Short machine line - one example of many

For medium capacity requirements. The workpieces are processed longitudinally and transversely in two work steps. This entails the return transport of stacks. Feeding and stacking systems as well as rotary stations from longitudinal to transverse format and from transverse to longitudinal format permit an automatic production flow.

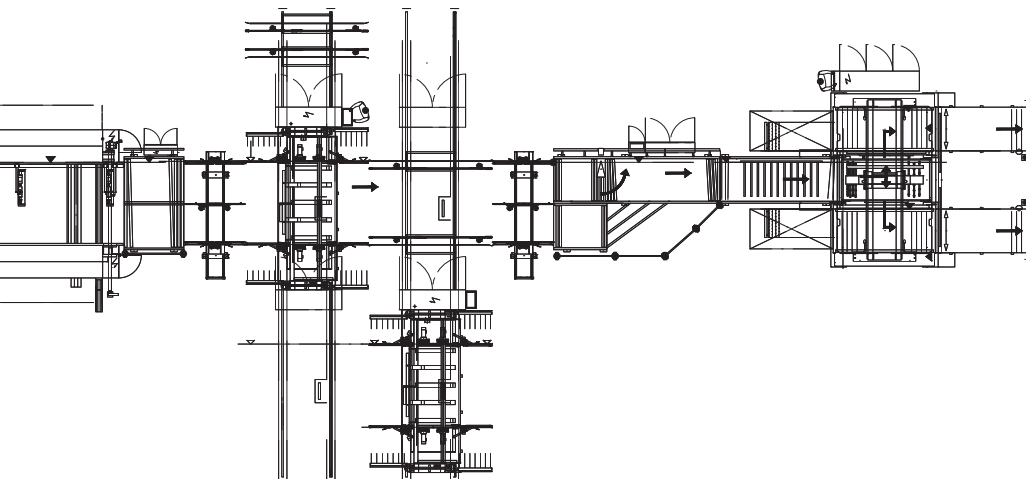

2) Production line - how your plant could look tomorrow

For the longitudinal and transverse processing of workpieces in a single pass for medium to large-scale series. Including feeding and stacking systems and automatic throughfeed drilling machines.

Flexible production down to batch size 1

Consumers are increasingly demanding bespoke personal furnishing solutions. In Europe particularly, the trend is now moving increasingly towards batch size one production. The K 600 always provides the right technical solution without compromising flexibility and output.

HOMAG Engineering: Concentrated competence and expertise

Project engineering by a HOMAG team has a range of decisive benefits to offer. The close links between the HOMAG Group members guarantee direct access to their specific fields of expertise. This substantially enhances the effectiveness of the project team and ensures that individual components (also from external manufacturers) can be networked and integrated into higher-level systems without problems. Countless successfully installed production lines for automatic complete processing testify to the outstanding competence of the HOMAG project team.

A single partner for all your processing needs

- To specify and formulate terms of reference
- To elaborate concepts and draw up a product brief
- To regulate commercial, legal and technical formalities
- To install and commission your finished plant

You purchase a complete system backed by the concentrated expertise of all the involved group companies.

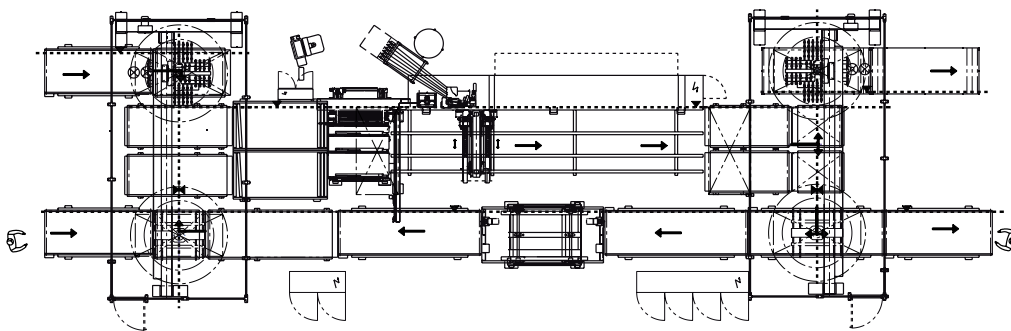

3) Batch size 1 - always effective

Production plant for longitudinal and transverse processing of minimal batch sizes down to batch size 1.

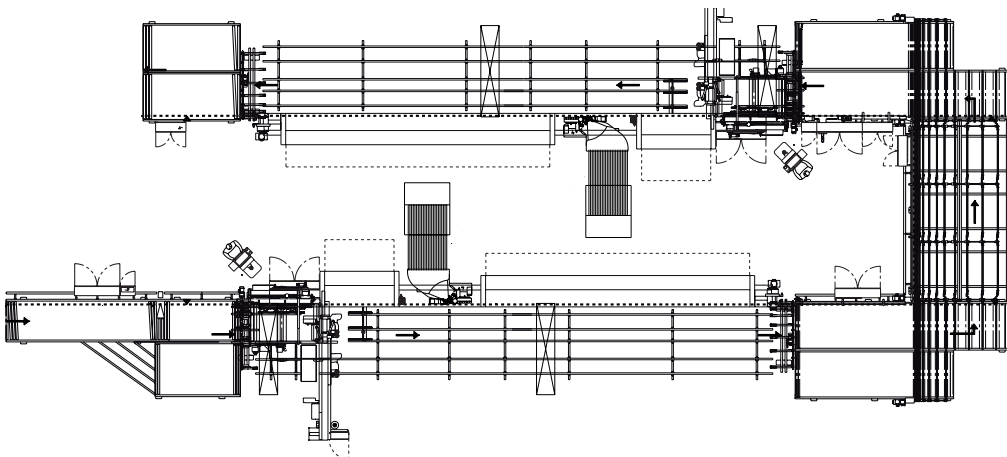

4) U line - innovation coupled with efficiency

For the flexible production of minimal series sizes. Workpieces are sized on two sides. Edge and finish processing take place independently of width on single-sided machines.

Greater economy due to a long service life and optimum availability

With their sturdy design and with optimum care and maintenance, K 600 machines will go on working for generations. We can show you a predecessor model which has been successfully producing for 40 years.

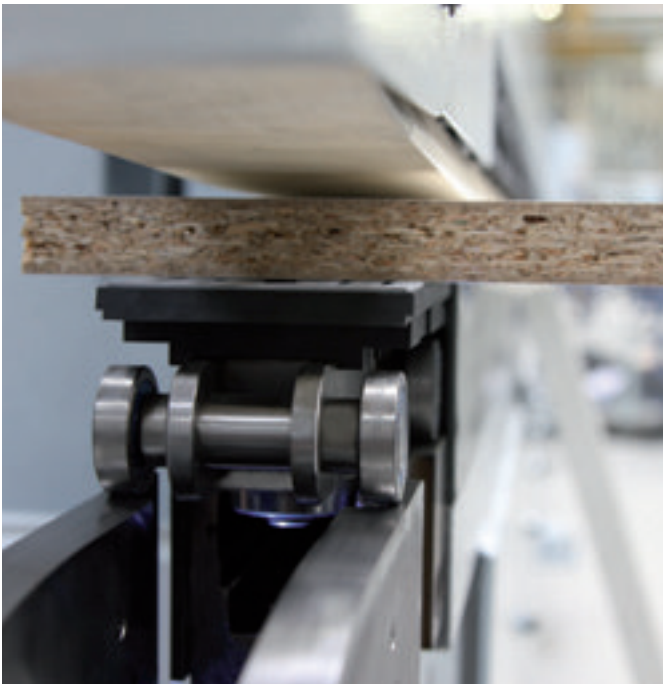

Superlative engineering

All machines of the K 600 series are equipped with roller block link chain. This progressive technology ensures that all workpieces are transported with pin-point precision and processed with extreme dimensional and repeat accuracy. The optimized chip and waste piece disposal enhances machine availability and service life. Experience has proven that the HOMAG block link chain is far less susceptible to wear than block link chain types with semi-circular rods. The proof: Outstanding performance over a feed distance of more than 200 metres even in dust-laden environments.



Robust and variable

The torsionally rigid dual frame construction of the machine base forms the foundation for the extreme processing precision of all offered units.

The variable frame design permits the entire HOMAG range of modular units to be accommodated on the K 600. Simply tell us what it is you require.

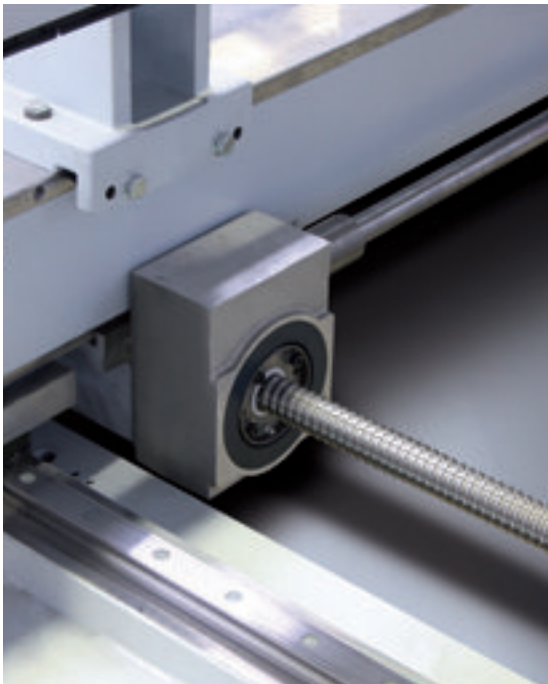

Width adjustment with the utmost precision

A drive system with ball spindle and linear guide as well as wear-free flat guides are used for reliable width adjustment.



Even better with double-sided processing

In double-sided machines, we use two drive systems linked by an “electronic shaft”. This means that the two sides of the machine have their own drive systems which work interactively. Long machines are fitted with two additional drive systems at the infeed to stabilize the transport chain. This ensures permanent angular precision during production.

Our range of modular units – always up to date

A wide range of different units is necessary to cope with varied processing operations.

We are continuously expanding our offered range of modular units. Ask us about flexTrim, flexBlade or the soon to be launched profile trimming unit FK31.



Jointing and alternating trimming – here every step is ideally intercoordinated

Top quality results can only be achieved by the smart coordination of every production step to achieve enhanced efficiency. This is precisely what HOMAG does: The units used for workpiece preparation provide the basis for perfect glue joints.

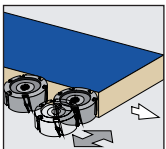
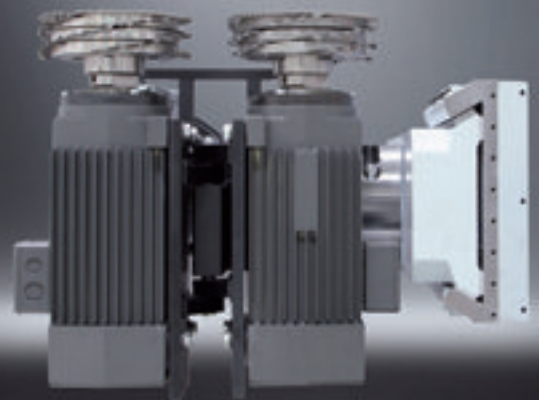
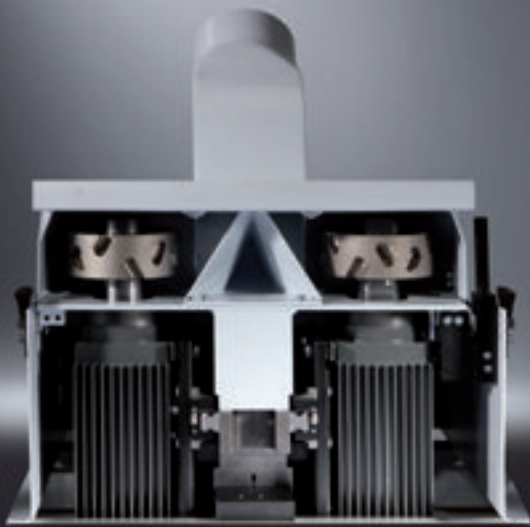

Jointing trimming

This unit permits a high level of processing precision, is extremely hardwearing and is also designed to ensure an above-average service life. The tool diameter is 125 mm.

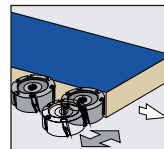

Compact alternating trimming unit KW12

If larger tool diameters than 125 mm or higher motor outputs are required for jointing trimming, the compact alternating trimming unit KW12 offers the perfect solution.

Sizing units – your assignment, our solution

HOMAG hogging units are true professionals when it comes to workpiece sizing.

Whether coreboard panels, surface layer overhang or transverse veneer – HOMAG plants are happy to cope with whatever you throw at them.

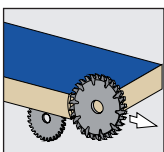

Scoring / hogging

Perfect sizing without splintering – even with coated or veneered panels. Pre-scoring unit optionally with lift-off fixture. Hogging unit with cross support and dust hoods.

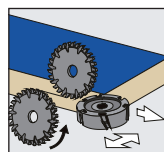

Compact double hogger KD11

With outputs of between 6.6 and 11 kW, even large processing allowances can be reliably hogged with a tidy, splinter-free cut.

For hogging workpiece sizing in longitudinal and transverse operation with three high-performance motors. Two hogging units with a diameter of up to 250 mm can be mounted.

- Automation to suit every need
- Automatic height adjustment
- Program controlled automatic overhang adjustment

Sizing and trimming – a neat performance

The output speaks for itself: HOMAG standard trimming units allow you to rebate, groove and profile – optionally also with tracing.

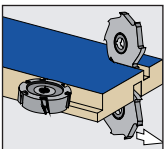
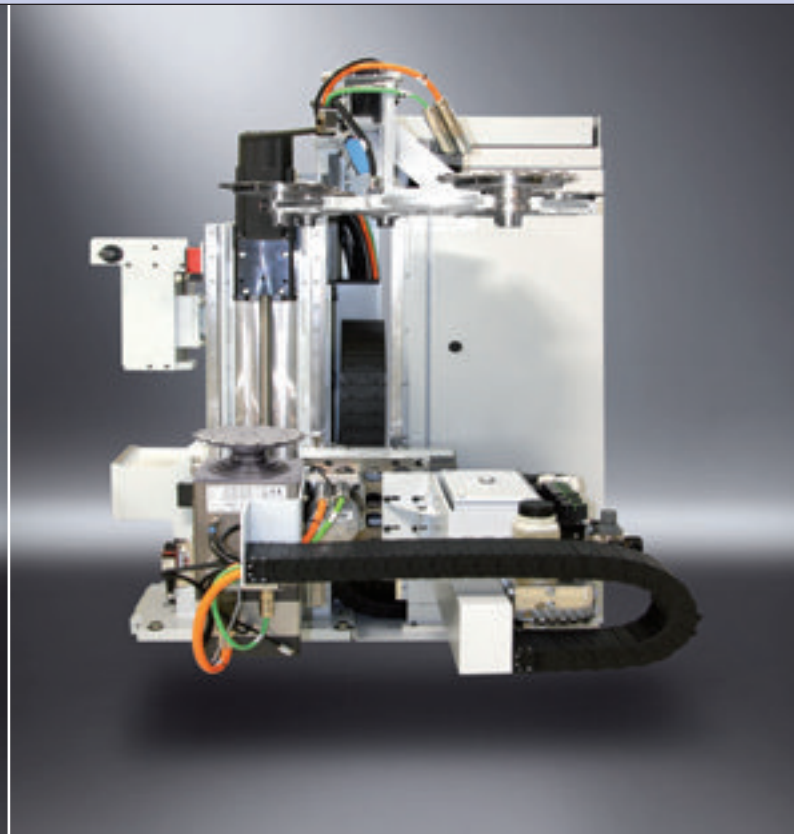
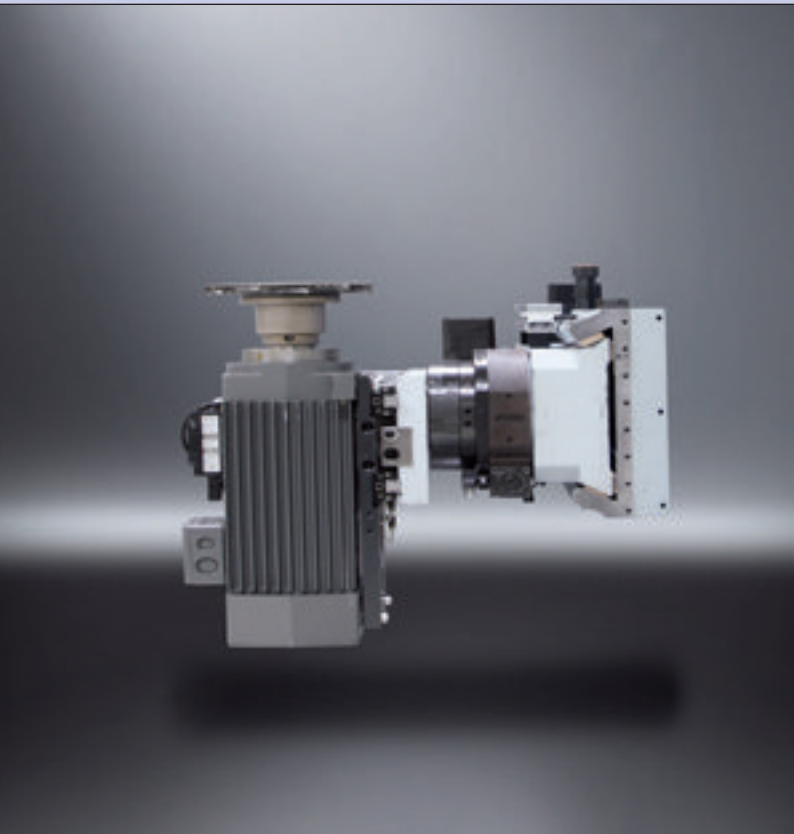

Standard trimming horizontal / vertical

Using the standard trimming unit, grooves and rebates can be trimmed precisely inside the machine without the need for an additional processing operation. Optionally also possible:

- Intermittent control with servo drive for optimum precision
- HSK pushbutton for fast tool change with high repeat accuracy

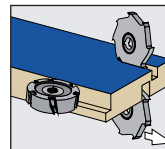

Trimming unit SF62

High-variance grooving, rebating and profiling. The HSK toolholder and 8-slot plate changer permit outstanding processing versatility. The servo axis affords optimum adjustment accuracy.

Gluing units – sticking with the best

HOMAG gluing units are ideal for a fast, positive connection. The standard gluing unit uses the pre-melt system. The heated glue roller ensures an optimum gluing temperature, while magazine height adjustment offers scope for processing wide-ranging different workpiece heights. A simple, toolless quick changeover of the application unit allows other glue colours to be deployed with a minimum delay.

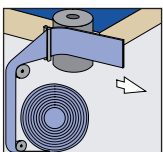
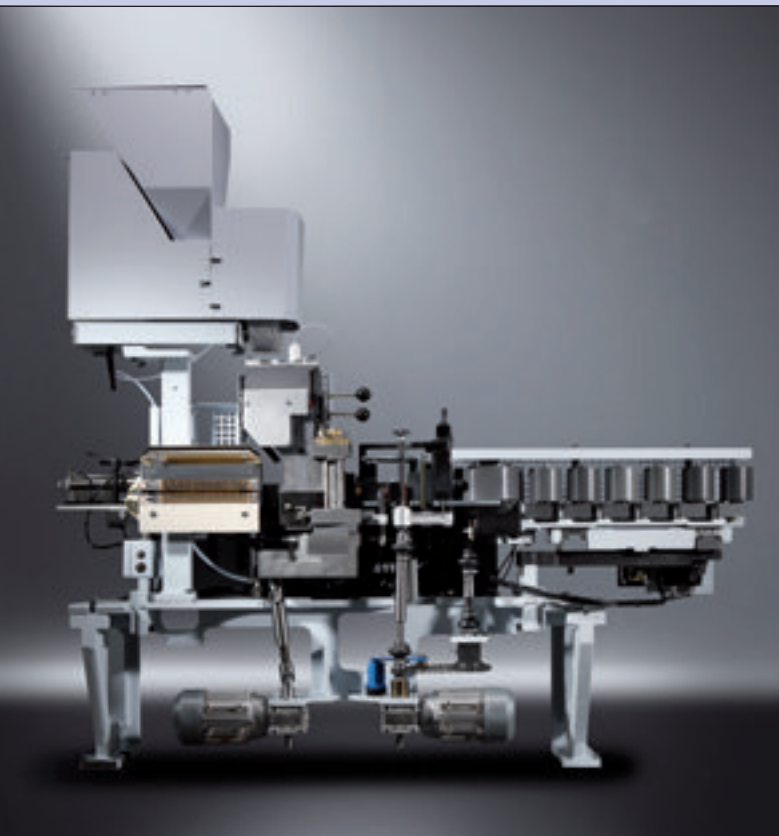

Hot-melt gluing unit

For optimum glue application on the narrow surface. Changes to workpiece thicknesses do not necessitate resetting of the glue application roller



Quick-release clamping system for application unit

A quick-clamping system is available for the application unit which permits fast hot-melt glue colour changeover. This allows hot-melt glue changeover without mixing the different glue colours.



Melting unit with granulate tank

With a melting rate of 18–35 kg/h, there is always plenty of hot-melt glue available. Even quantities of up to 45 kg/h pose no problem.

PU melting unit

A range of possibilities are available for melting PU. Ask us.

laserTec – the quantum leap in furniture production

Edge banding to a previously unattainable standard of quality: HOMAG laserTec is the name of a new production method which is set to revolutionize furniture manufacture. It entails melting the surface to be glued using a laser beam and then pressing it directly onto the workpiece. The result: Edges complying to the highest conceivable standard of quality.

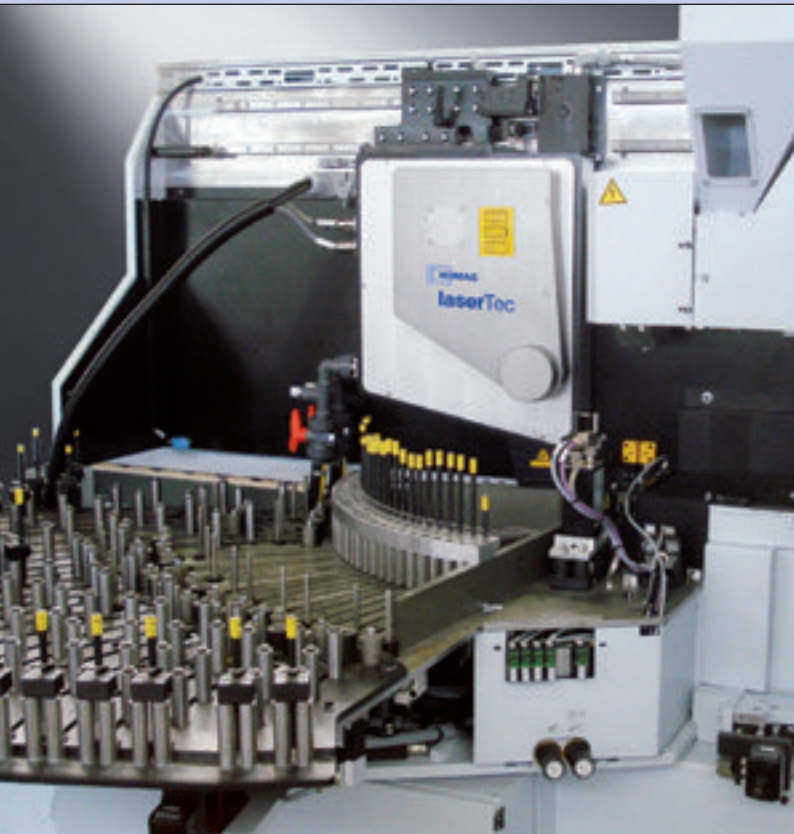

For the entire laser edge spectrum

HOMAG laserTec can be used to process all customary types of edging such as PVC, ABS, PP, PMMA, wood veneer or melamine. The laser-active layer can be individually adjusted in line with product and customer requirements.

HOMAG laserTec achieves extreme production economy:

- Reduced rejects quota
- Simple operating processes
- Low ancillary costs
- Maximum availability
- Reproducible production parameters
- Resource-saving production
- Extreme production reliability

Edge feed: Versatile and precise

Servo edge feed does more than just sound impressively high tech – it actually cuts out edging waste and so tangibly reduces unit costs. We have actually patented this precisely dimensioned edge feed system with its minimal workpiece corner overhang – after all, it was invented by HOMAG. HOMAG offers you a wide edge feed spectrum, from single and dual magazines right through to a changer with 48 or even more slots.

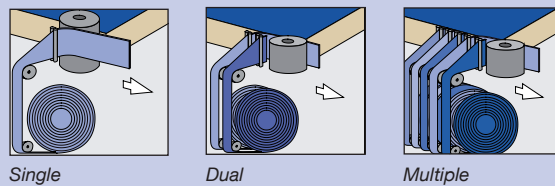

Previous gluing technique

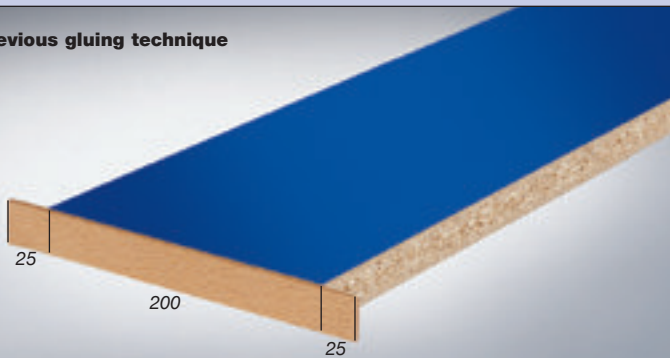

Dimensions in mm

Optimized gluing technique with servo edge feed

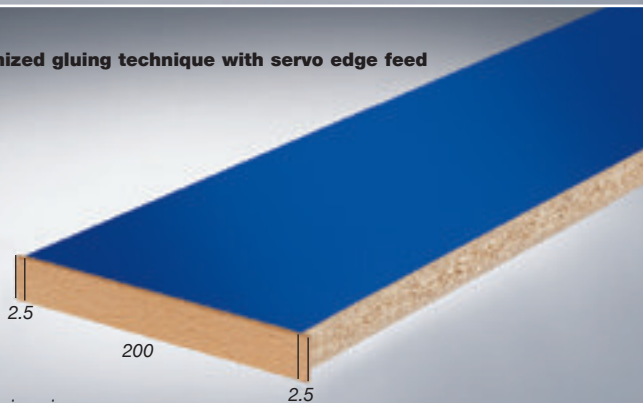

Dimensions in mm

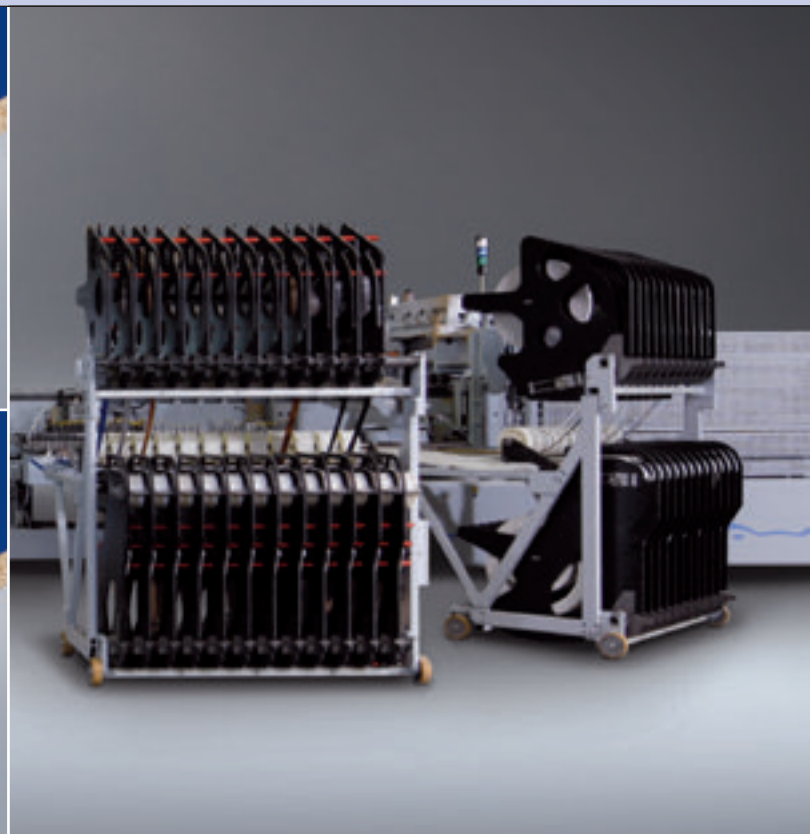

Lower waste, fewer costs

The servo edge feed system feeds the edging material precisely dimensioned to the workpiece corner with only the barest minimum overhang. It permits leading and trailing edge precision of $\pm 2-3$ mm.

Multiple edging magazine

Given today's enormous production diversity, a multiple edging machine is an almost indispensable aid in the modern furniture factory. The spectrum ranges from single and dual magazines right through to changers with 48 slots or even more, allowing edges ranging from 0.3 to 3 mm to be processed with ease.

Softforming – raising the profile of your edges

HOMAG edge banding machines are the creative stars of the furniture production world:

Thanks to softforming technology, the profile shapes available to edge designers range from roof and drum profiles through to S-shapes or inlay profiles.

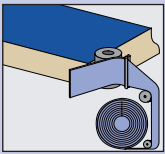

Softforming unit with pressure zones for different profiles

With a melting unit capable of processing 18–35 kg/h, there is always plenty of hot-melt glue available. If required, the melting output can be increased to as much as 45 kg/h using elements from the tried and tested range of HOMAG modular units.

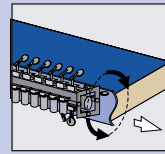

Four-fold multiple pressure zone G

With a set of pressure rollers for straight edges. This comes with an additional three free spaces. Simply turning the pressure zone changes the profile. The pre-set profile rollers of the roller set can be quickly and easily exchanged. Optional: Profile pressure pad sets

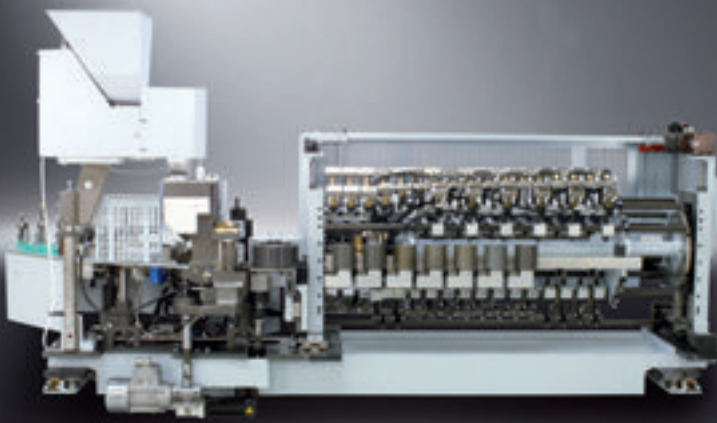

Softforming profiles



Roof profile



Drum profile



U-shaped inlay profile



S-shaped profile



L-shaped inlay profile

A design element with scope for added interest

HOMAG machines offer interesting scope for creative edge design with the aid of softforming technology. The profile shapes range from roof and drum profiles to S and inlay profiles.

Snipping units – for perfect preparation

Presenting a range of true team players. Snipping units never aspire to steal the limelight, but play an essential supporting role: That of preparing workpieces for subsequent trimming. The face side can be snipped either straight or with chamfer.

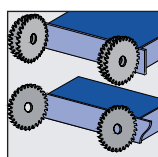
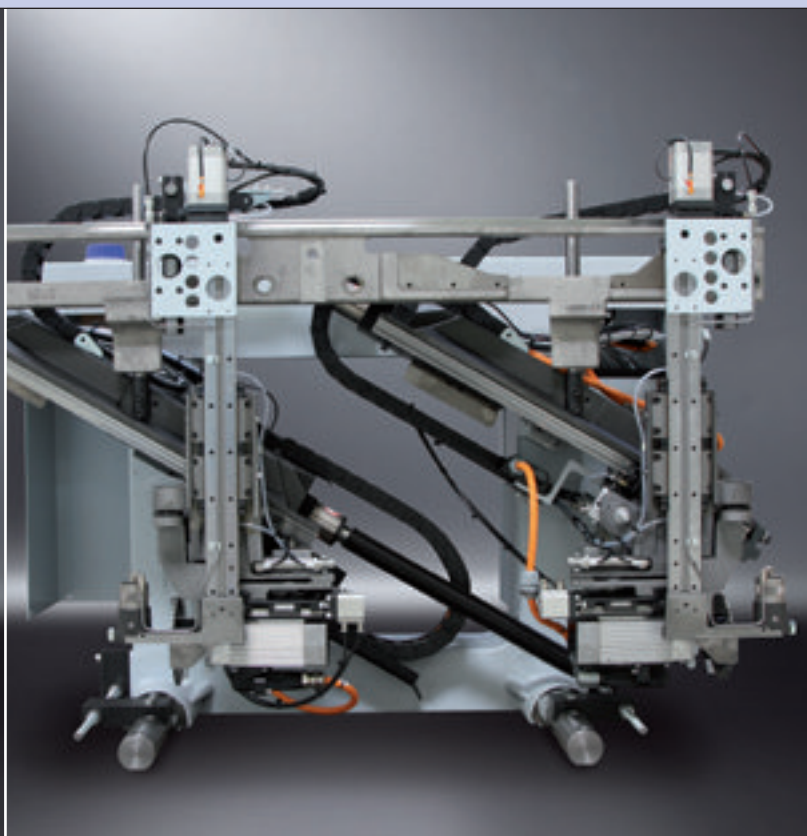

Snipping unit HL84

For snipping the edge overhang at the leading and trailing workpiece edge with stationary snipping stop to protect sensitive workpieces from damage. Drawing snipping cut for optimum snipping saw cutting quality.

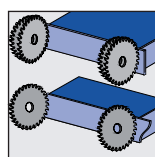

Snipping unit HL86

For snipping the edge overhang at the leading and trailing workpiece edge with stationary snipping stop to protect sensitive workpieces from damage. Drawing snipping cut for optimum snipping saw cutting quality. Linear motor for feed rates of up to 35 m/min. and a high standard of processing quality.

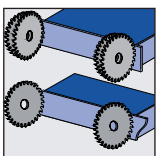

Snipping unit WK13

For snipping the edge overhang at the leading and trailing workpiece edge with stationary snipping stop to protect sensitive workpieces from damage. Optimum cutting quality of the snipping saw at feed rates of up to 35 m/min. Workpiece thicknesses of up to 100 mm are processed with ease.

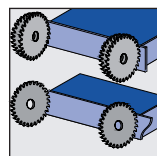

Snipping unit HK13

For high-performance snipping of the leading and trailing workpiece edge overhang. Naturally with stationary snipping stop to protect sensitive workpieces from damage. Optimum snipping saw cutting quality. Servo drive for feed rates of up to 60 m/min. and a high standard of processing quality.

Flush trimming – the solid basis for edge processing

HOMAG trimming units give the workpiece edge its required shape. Even using our basic units, practically-oriented solutions are guaranteed.

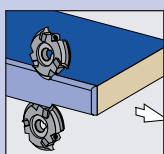

Rough trimming unit BF20

For rough trimming the upper and lower edge overhang.

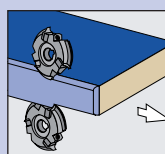

Trimming unit PF20

For trimming edge chamfers or radii. Options: Stepless or pneumatic adjusting devices for the trimming motor. Trimming motor exchange using exchange units.

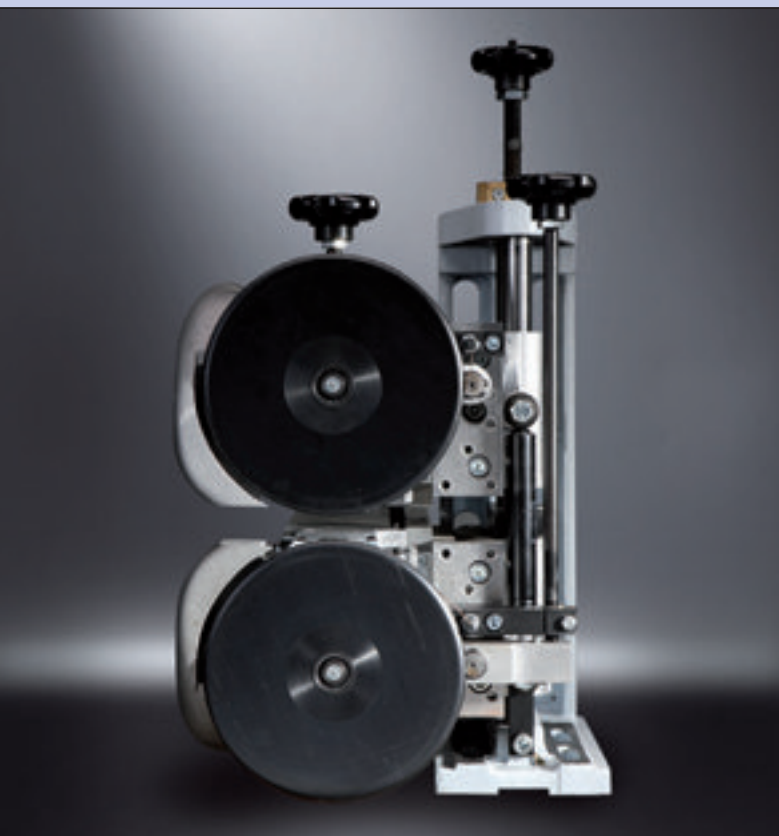

Automation to suit every need

Rough trimming unit

For automatic changeover from flush trimming to trimming with edge overhang.

Solid mouldings



PVC



Multi-trimming unit MF21

For automatic changeover between different profiles, e.g. chamfer 20°, R2 and R3.



Profile trimming – for advanced trimming proficiency

HOMAG profile trimming units are true professionals when it comes to trimming. As a user, your job is to program any profile that takes your fancy: Then stand back and watch the extreme speed and precision of the expert execution. The efficient mode of operation results in higher productivity. Our dual-motor profile trimming units permit both corner rounding and trimming of upper and lower overhanging edges.

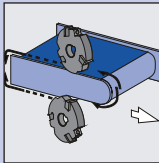

Profile trimming unit FK11

For processing overhanging edges. Also for trimming around the leading and trailing edge.

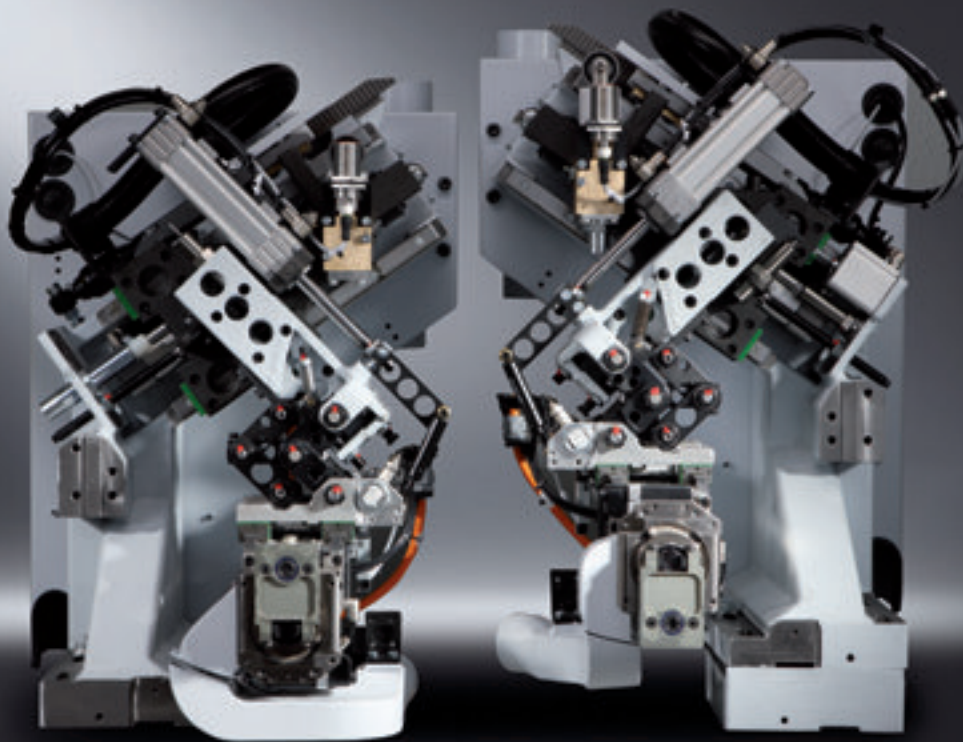

Automation to suit every need

Chamfer/radius adjustment for fast changeover from for instance 0.4 mm to 2 mm edges.

Profile trimming unit FK13

For processing overhanging edges and trimming around the leading and trailing edge. With 8-slot tool changer.

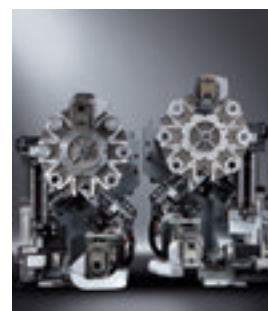
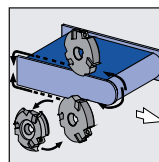

Servo profile trimming – making you even more mobile

If your expectations are high and you expect more output, greater contour versatility and even higher quality, then we recommend our servo profile trimming units. Here too, greater productivity means reduced unit costs.



Profile trimming unit FK31

The FK31 is available for quality and performance using the very latest technology. You cannot help but be impressed.

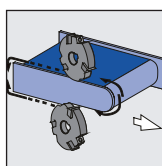
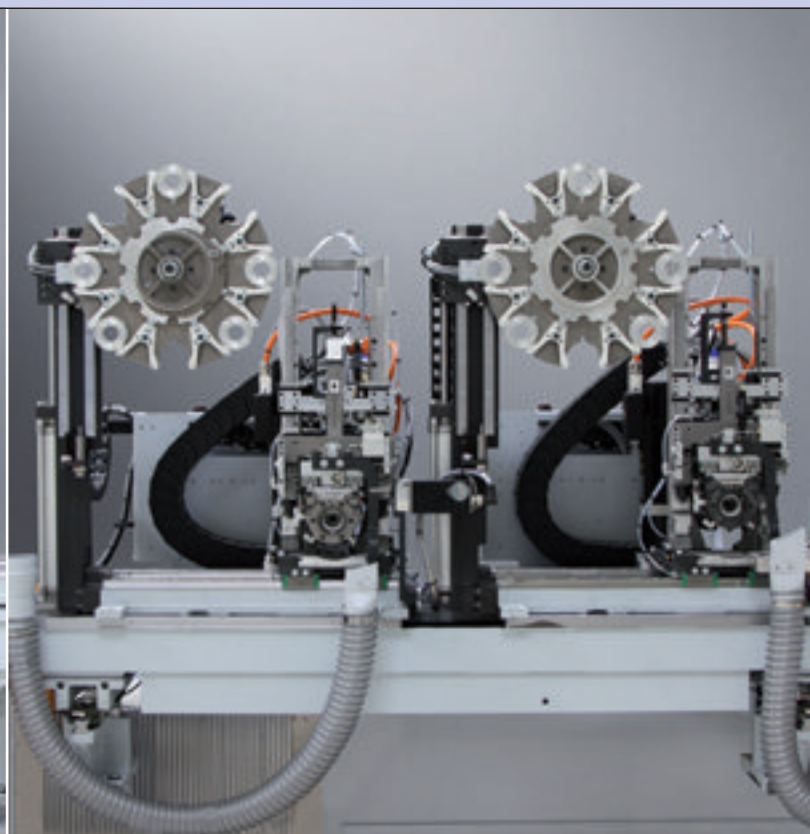
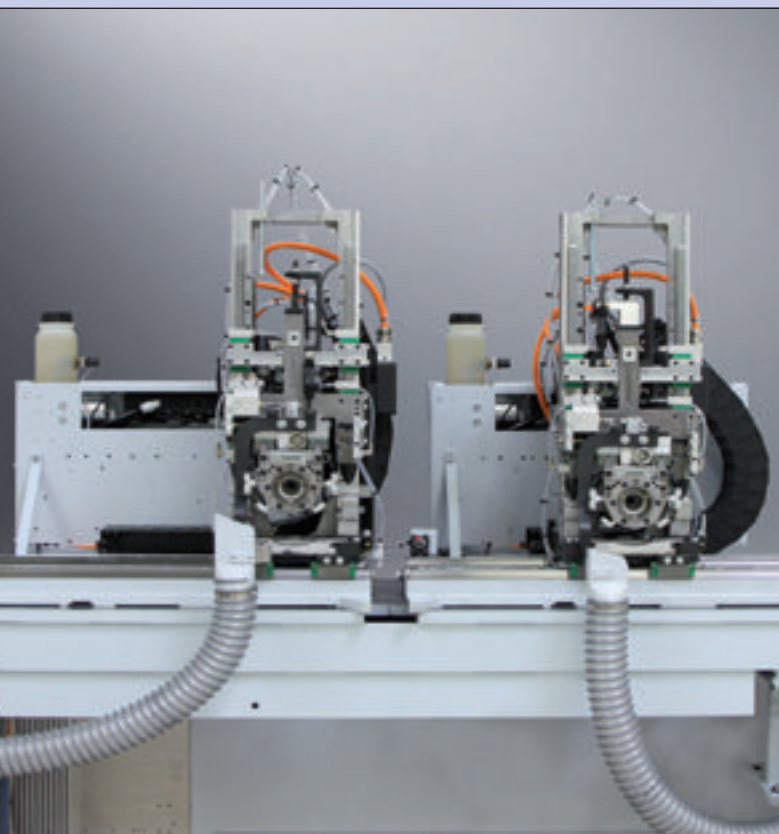

Profile trimming unit FK21 Servo

For processing overhanging edges. Also for trimming around the leading and trailing edge. Servo drive for high dynamics and optimum processing quality from 20 to 35 parts/min.

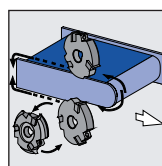

Profile trimming unit FK23 Servo

For processing overhanging edges and trimming around the leading and trailing edge. With 8-slot tool changer. Opens up free scope for profile and material versatility. Servo drive for high dynamics and optimum processing quality from 20 to 35 parts/min.

Automation to suit every need

Chamfer/radius adjustment for fast changeover from for instance 0.4 mm to 2 mm edges.

Four-motor profile trimming units – take anything easily in their stride

The four-motor HOMAG profile trimming units ensure reliable corner rounding even when processing veneer. If you are looking for a unit for the efficient flush trimming of the top and bottom workpiece surface – look no further.

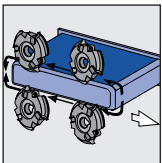
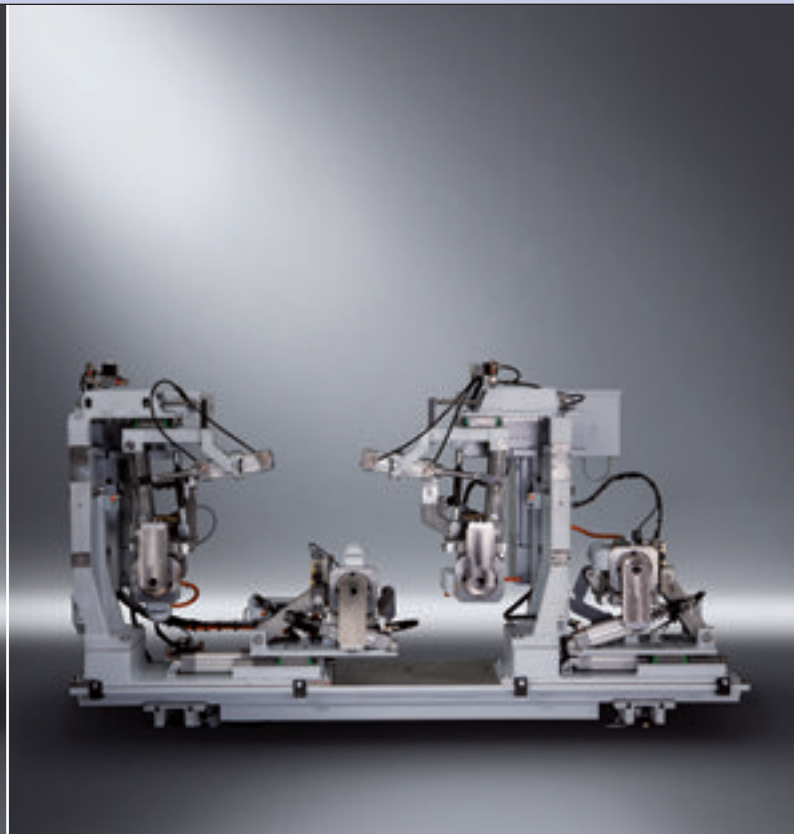

Profile trimming unit FF32

For rounding top and bottom edges on the leading and trailing workpiece edges. By dividing the cut over four motors, each corner can be processed in synchronous rotation, so reducing the risk of splintering even with veneer.

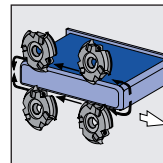

Pneumatic profile trimming unit FF22

For four-motor profile trimming at 35 m/min., optionally with servo drive 45 m/min.



Finish – all's well that ends well

The same principle applies to product as to running a marathon: Those who persevere to the very end will achieve their goal. For a perfect finish which has you running victoriously to the winner's podium instead of tripping over the finishing line, place your trust in HOMAG.

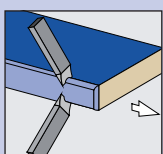

Finish profile scraping unit PN20

For smoothing trimmed edges to achieve an optimum appearance.

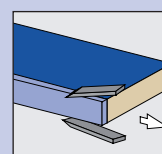
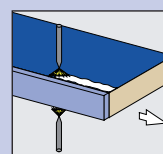
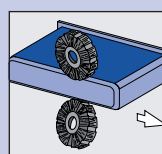

Multi scraping blade MN21

For automatic changeover between a maximum of five different profiles.

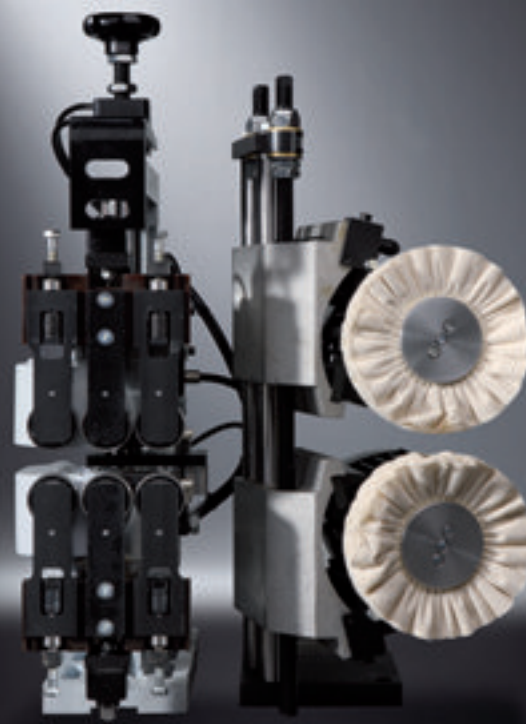
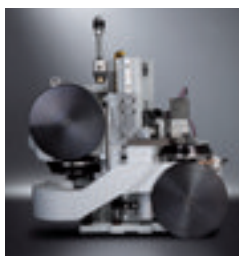

Finish processing unit FA11

Comprising a glue joint scraping unit, cleaning agent application and buffing for disposal of glue residues on PVC edges.

Profile buffing unit FS24

The servo profile buffing unit takes care of an all-round perfect finish.

Finish belt sanding - always on top form

Whether straight veneer or solid edges, chamfers or radii: Our HOMAG belt sanding units will take them all easily in their stride

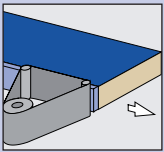

Belt sanding unit KS10

For sanding straight veneered and solid edges including oscillation as a standard feature.

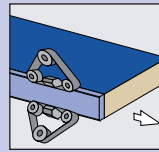

Chamfer/radius sanding unit PS41/PS42

For sanding chamfers and radii at the top and bottom of veneered and solid wood edges.

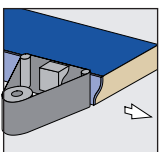
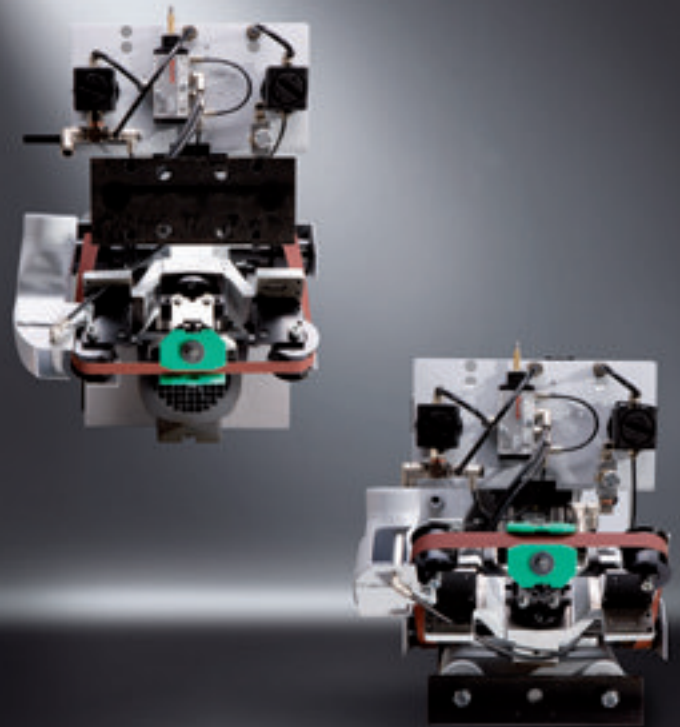
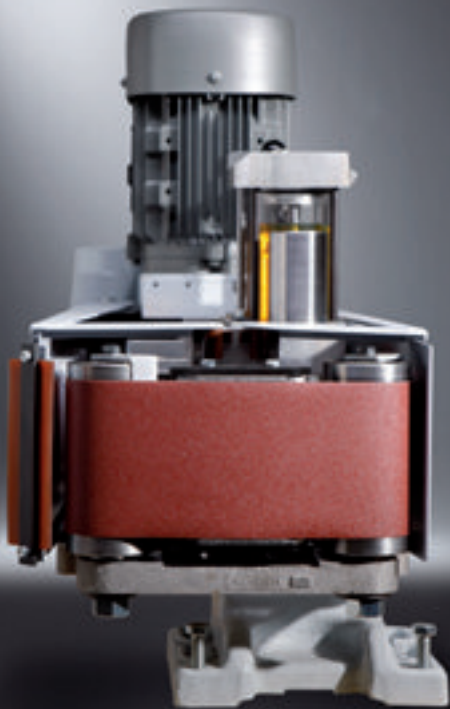

PS10

For profile sanding.

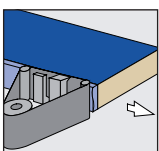

PS20

For profile sanding using dual pad technology with two separately adjustable sanding pads.

Automation to suit every need

- For traversing out of the work area
- For stepless adjustment to different edge thicknesses

To ensure simple operation and control, we have invested the time that you don't have

You cannot afford to spend weeks trawling through the operating instructions to ensure optimum machine utilization. This is why we design HOMAG plants to make simple operation and reliable control a matter of course. In the HOMAG K 600 series, for instance, manual intervention in the machine's control system has been reduced to a minimum. Even in the basic standard model, a wide range of functions are available to allow future upgrading of the functional scope and to enhance operating convenience and productivity. Our specialists are ready and waiting "on standby" to address any customer-specific requirements.

Standard



powerControl PC22

This modern, highly flexible control system offers a range of additional functions for the simple, reliable operation of your machine:

- User-friendly menu prompting using the Windows-XP standard
- Large 17" display affords a clear overview of all machine functions
- Easily understandable plain text messages in the local language

These benefits combine to ensure a production-ready machine as and when you need it.

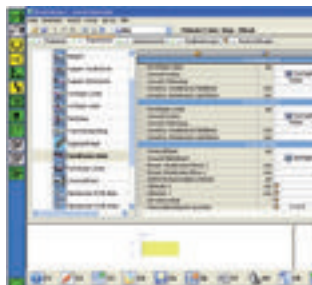

Programming with woodCommander

The programming system for all HOMAG throughfeed machines. Extreme user convenience due to graphically supported input masks for simple navigation and menu prompting.



USB port

Data input and data safety using external USB storage facilities ensure simple data handling and provide the assurance of a production-ready machine.



Evaluation with Schuler MDA basic

The acquisition of piece numbers and actual operational times at the machine provides meaningful information about your machine's productivity. Integrated prompting ensures timely execution of necessary maintenance work in keeping with the maintenance schedule.



Options

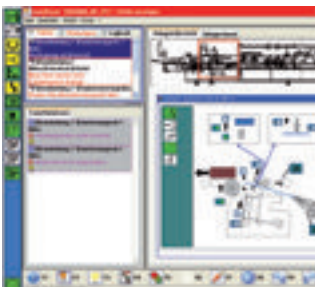

Diagnostic system woodScout

High-performance diagnostic system which as well as providing plain text messages also offers a graphic indication of the fault location at the machine.

The facility for saving remedial actions in the woodScout memory permits the expert knowledge supplied with the diagnostic system to be continuously extended by the customer.



Schuler MDA professional

By upgrading from Schuler MDA basic, users can obtain a detailed breakdown of actual operational times into production time, set-up time, down time due to faults and down time due to interruptions. The integrated shift management and logging system allows production data to be acquired and evaluated on a user-dependent basis.

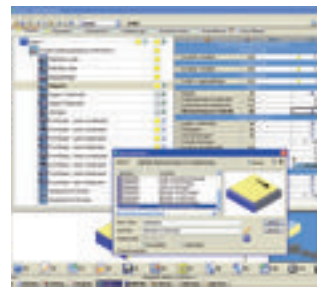

Macro programming

Macro programming is all about one thing: Simplification. The overall machine program has been broken down into subroutines known as macros. The machine control system manages each individual macro. These can be combined at will as required. Using this method, the functional parameters are retained separately without direct assignment.

In this way, new component variants can be described simply by combining already existing macros without the need for new programming.

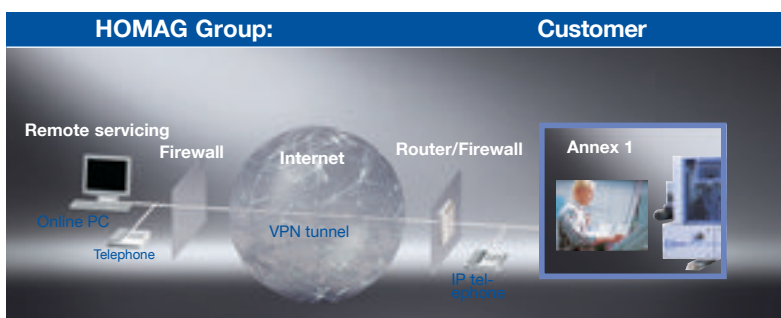

TeleServiceNet

Selective fault analysis and diagnostics using Internet technology offer scope for rapid service and assistance. With a single connection, all the machines of a production line can be accessed right down to the last link in the control chain.

Productivity – only as good as the control system

To increase the productivity of machine lines and production cells, HOMAG relies upon the PC52 control system. This allows more workpieces to be processed per shift, and offers scope for economical and varied production. This not only cuts out operating errors but also allows a reduced staffing requirement. You may safely place your trust in our many years of experience with over 500 successfully installed systems the world over.

Functional characteristics for improved performance*

- Central production cell operation and monitoring
- Automatic data distribution in the production cell by part tracking and machine networking
- Production sequence control using list management
- Improved performance due to automatic cyclical output and calculation of the gap between workpieces
- Edge preview to reduce standstill times due to missing edging material

Functional characteristics for data organization*

- Central generation and management of component information in an MS-SQL database
- Component identification through automatic and manual bar code reading systems
- Component identification using labelling and ink jet solutions
- Stack management with integrated print-out of stack accompanying documents

Functional characteristics to enhance availability*

- woodScout diagnostic system for central display of all line error messages at the cell master computer
- Fast, reliable troubleshooting and remedy using the worldwide teleservice

Factory control

Cell control system

Machine control

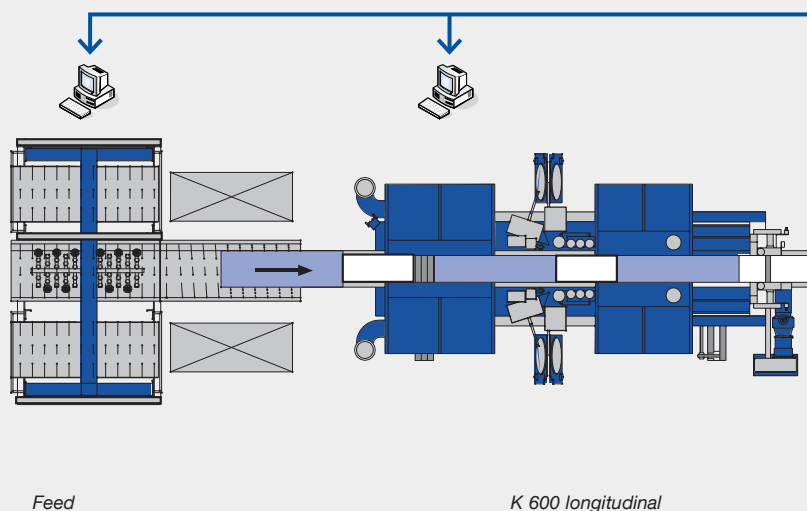

* some functional characteristics and interfaces are optional



Connection to

- PPS (production planning and control)
- FLS (manufacturing execution system)
- ERP
- Trade-specific software

PC52

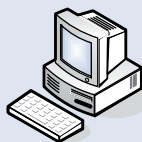

Interfaces for

- Edge information
- Component description
- Stack information
- Production statistics (completion notices)
- Teleservice
- Monitoring & reporting

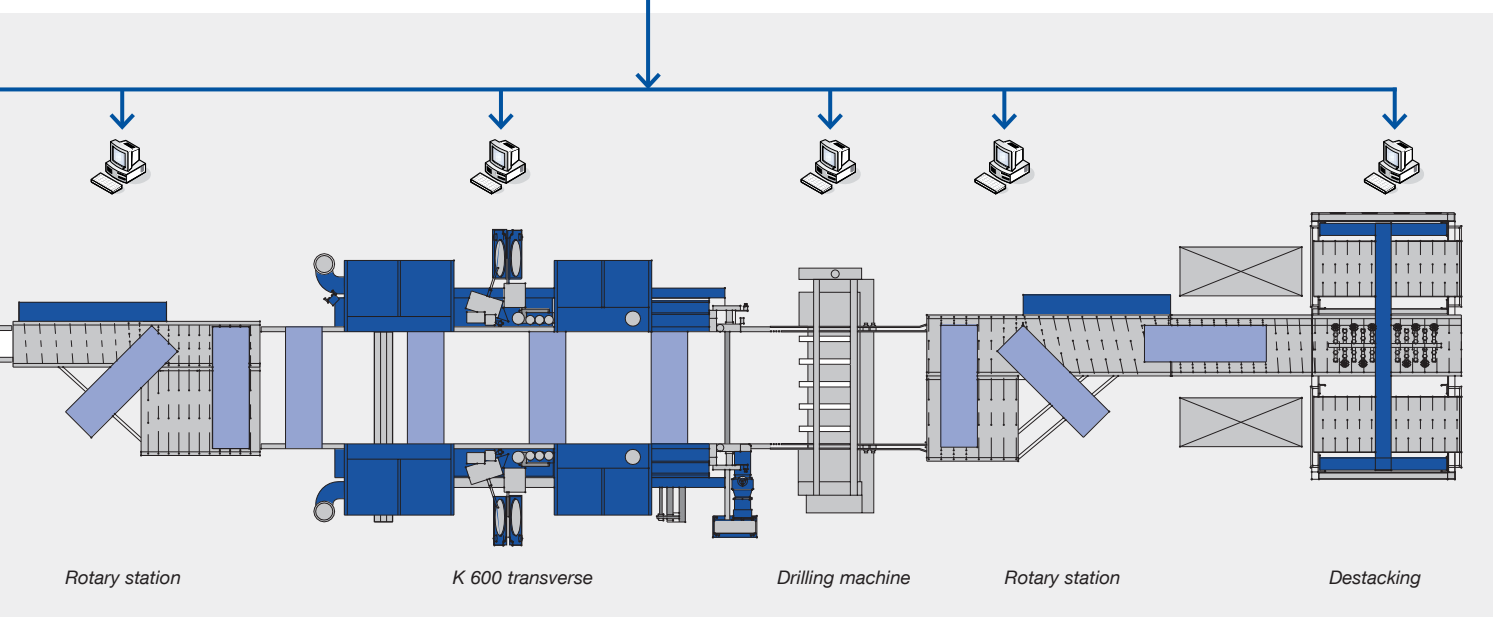

Rotary station

K 600 transverse

Drilling machine

Rotary station

Destacking

You invest, we reduce: Life cycle cost management

It is not the investment costs which decide the economic success of your production, but the capacity utilization and unit costs. This is why our primary objective is to combine top class production with higher productivity and consequently lower unit costs.

Unit cost reduction through:



Optimum financing

- HOMAG Finance offers optimized financing concepts based on individual business administration requirements. The outstanding value stability of HOMAG machines offers benefits in terms of leasing and subsequent replacement investment

High level of processing quality “without” finish processing

- Perfectly coordinated machine configuration

Practically oriented training

- Targeted training, cutting time to full productivity
- Employees are prepared for safe, efficient machine operation

Reduced unit labour costs

- Fast, simple operating capability of machines
- Simple resetting processes

High degree of machine availability

- World-wide service reduces machine downtimes
- TeleServiceNet – our “eye” into the machine eliminates the need for costly service callouts
- woodScout diagnostic software – intelligent self-help for all machine operators

Fast achievement of productivity

To get you quickly up to your targeted high shift output, our employees will visit your company to ease you into the start of production. This will take you faster to your targeted production output.

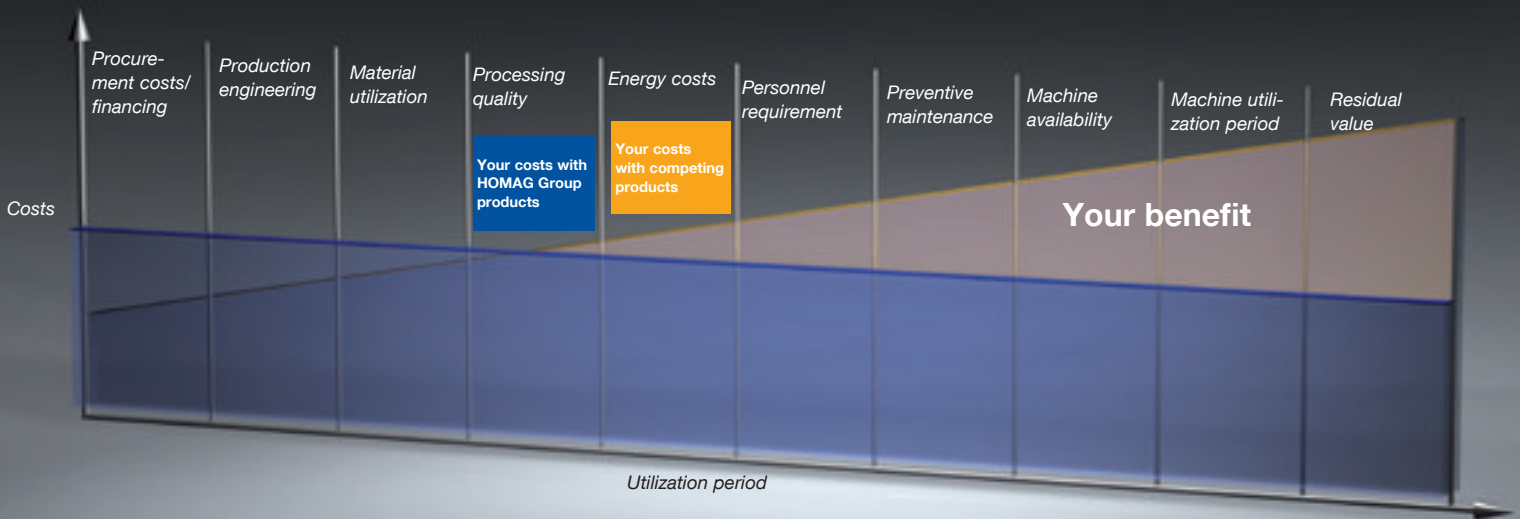

Low energy costs*

- Intelligent stand-by operation reduces energy costs during break periods by up to 90 %
- A valve control system switches the extraction on only for units which are actually operational. This reduces extraction costs by up to 20 %
- I-tools reduce the necessary extraction speed per individual I-tool. Current consumption per machine is reduced in this way by around 1,250 kWh. This does not take into account savings due to room air which requires no extraction (heating / air conditioning)
- With the PC22 control system, the switch cabinet is cooled by means of cooling plates / fins at the rear without using a powered fan. This passive cooling system requires no energy. No filters need to be exchanged. Maintenance costs are saved. The system also remains closed. No dust is able to penetrate

Machine utilization period

- Capability for continuous expansion of functionality ensures compliance with the requirements of tomorrow
- The HOMAG conversion department offers solutions to address major conversion requirements, ensuring a high degree of investment security over years

Preventive maintenance

- Regular inspections and preventive maintenance help avoid machine faults and extend service life
- MDA software informs the machine operator about scheduled maintenance requirements and provides cost transparency for calculation



* depending on equipment configuration, service period and workpiece spectrum.

Technical data K 600

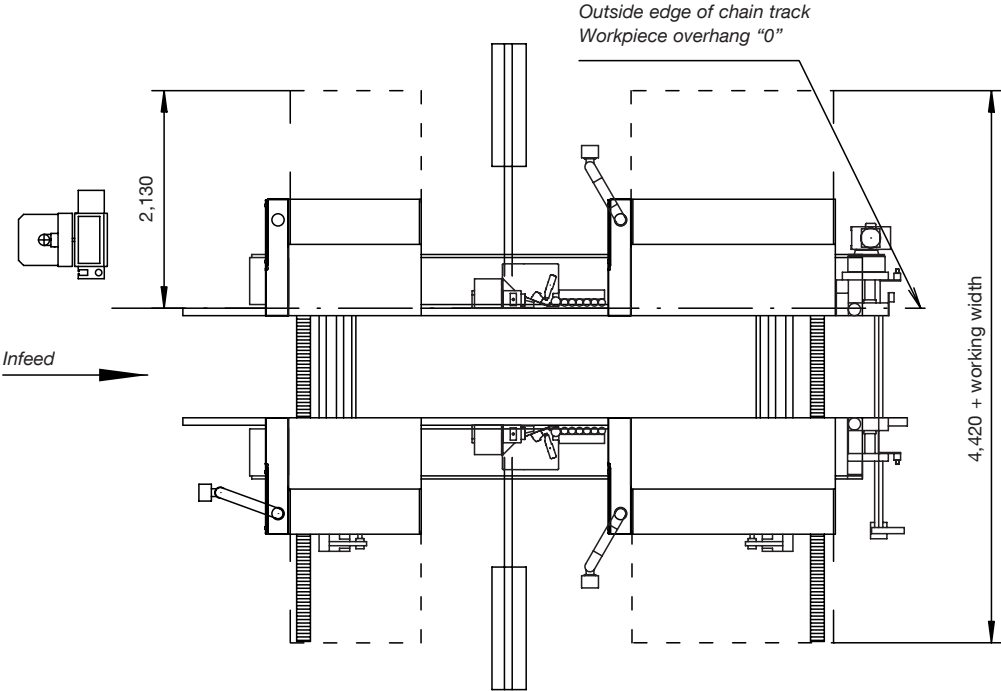
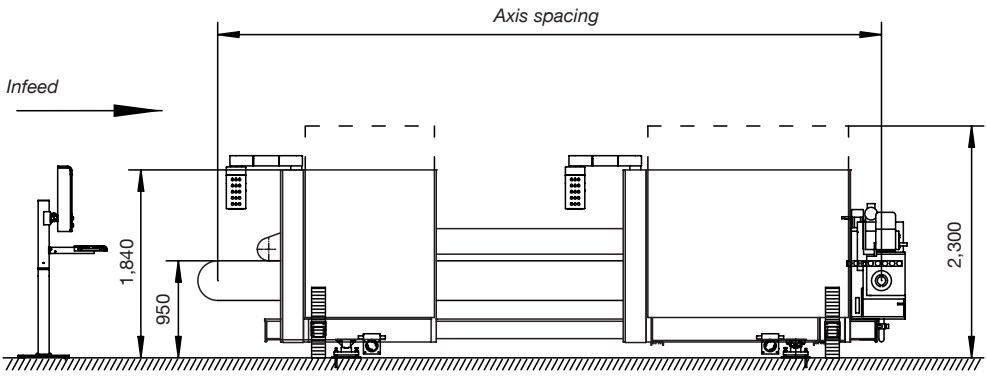

Dimensions in mm

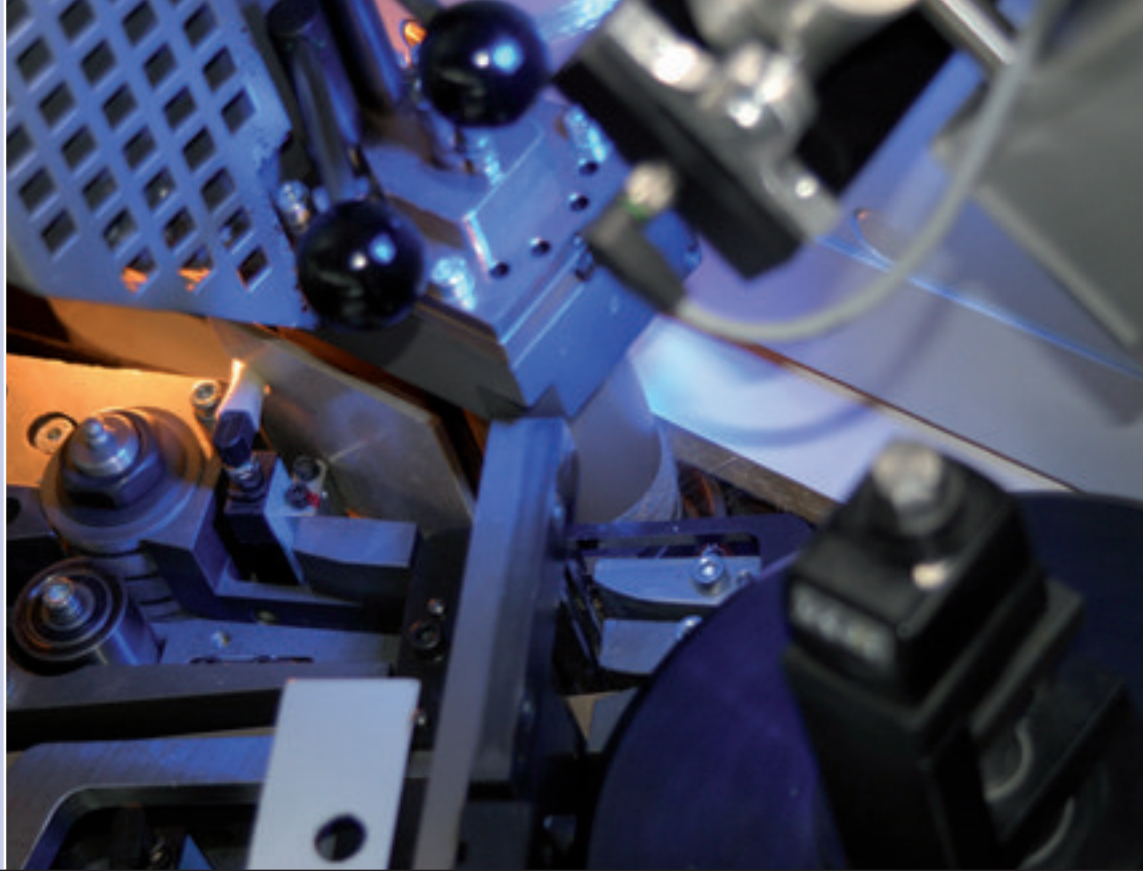

Machine dimensions

Overall length [mm]	According to machine type
Working height [mm]	950
Noise protection covers	
Overall width closed / opened [mm] plus relevant working width	2,300 / 3,830
Overall height closed/open [mm]	1,840 / 2,500

Connection values

Operating voltage	400 V / 50 Hz
Control voltage	220 V or 24 V
Total electrical connected load [kW]	depending on equipment
Overall suction output [m ³ /h]	depending on equipment
Chip conveyor belt	Optional
Air speed (extraction) [m/sec]	28
Pressure loss [mm/wg]	250
Suction nozzle	depending on equipment
Compressed air connection [bar]	6–8
Compressed air consumption [nl/min.]	depending on equipment

Working dimensions

Workpiece width	
min. double sided [mm]	240
max. double sided [mm] (graduation) [mm]	1,000–4,000 500
Workpiece thickness [mm]	12–60 (optionally 8–100)
Workpiece overhang	
Fixed [mm]	40
Optionally adjustable [mm]	30–110

Miscellaneous

Feed steplessly adjustable [m/min.]	10–40 (optionally 80)
Width adjustment speed	
Standard [m/min.]	2.6
Machines with servo axis [m/min.]	20
Dog spacing / standard [mm]	1,000
Dog height / standard [mm]	11
Optional stepless dog height [mm]	up to 25

Content, technical data and photos are not binding in every detail. We reserve the right to make changes.



A member of the HOMAG Group



HOMAG Holzbearbeitungssysteme GmbH

Homagstraße 3-5
72296 SCHOPFLOCH
GERMANY

Tel. +49 7443 13-0
Fax +49 7443 13-2300
info@homag.de
www.homag.com

www.hoechsmann.com