



The cutting center controlled in 3 or 5 axes determined for the production of models, patterns, trimming of the plastic pressings from the vacuum presses or laminates, etc. The work material can be the alloys of aluminum and non-ferrous metals, timber, plywood, fiberboards, plastic materials, epoxy and polyurethane resins, laminates, etc.

The machine is in a 3-axis type fitted with precision hand-adjustable tilting head (3 NC axes X, Y, Z + 2 manual axis A, C). This allows for smooth tilting spindles in two angular axes. This can be achieved by tilting the spindle into any vector. For ease of setting up the angle is the head equipped with a scale (vernier). Lock of set angle is then carried out mechanical reinforcements. This solution ensures high rigidity of the entire system. High-efficiency electro-spindle with water cooling and pneumatic-release tool is fitted with ceramic bearings. Spindle can be equipped with a position sensor for automatic threading.

<b>Head with manual titling in 2 axis</b> (3 NC axis X, Y, Z + 2 manual axis A, C), electro-spindle ES789		
Working range in axis A	°	0 - 100
Working range in axis C	°	±400
Clamping cone		HSK F 63
revolutions per minute	rpm	0 - 18000
Output of spindle S6 (S1)	kW	18 (15)
Torque S6 (S1)	Nm	19,1 (15,9)
Cone	HSK	F63

# 5 axis machine



The machine is in 5-axis design fitted with a precise automatic tilting head HS 653 (5 NC axes X, Y, Z, A, C). This allows fast and precise tilting spindle of indexed machining 3-axis or continuous 5 axis machining. For apart heavy machining is the head of HS 653 equipped with a hydraulic hardening. The head can be ordered in implementing STANDARD (machining aluminum alloys, production of models and molds) or in execution QUICK (offsets plastics, composites, serial production of furniture parts, etc.) High-efficiency electro-spindle with water cooling and pneumatic-release tool is fitted with ceramic bearings. Spindle can be equipped with a position sensor for automatic threading.

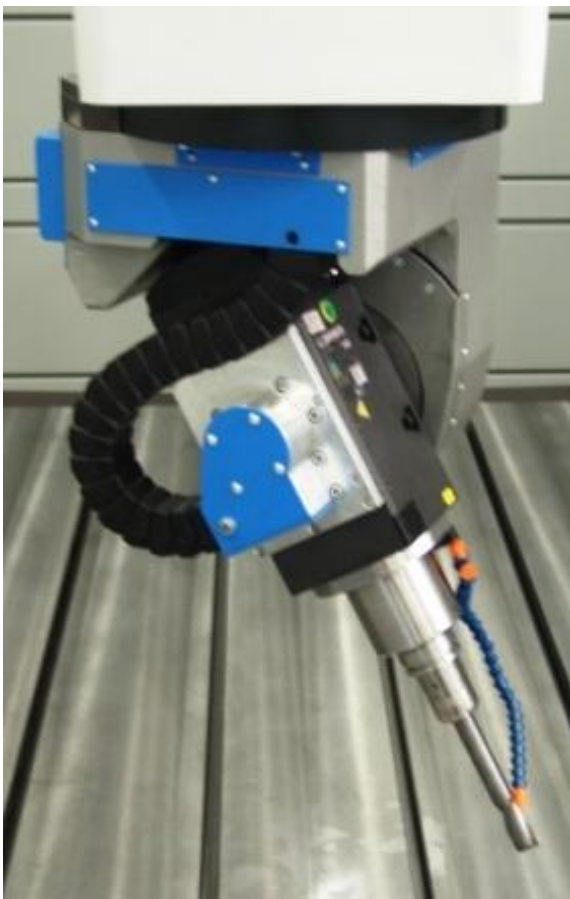

Rotational and titling head HS653 with spindle ES 789			
		STANDARD	QUICK
Working range in axis A	°	-10 - +125	-10 - +125
Working range in axis C	°	±400	±400
Max. movement in axis A/C	°/min	2500/3000	5000/6000
Servomotor axis A/C	Nm	1,5/5,2	1,5/5,2
revolutions per minute	rpm	0 - 18000	0 - 18000
Output of spindle S6 (S1)	kW	18 (15)	18 (15)
Torque S6 (S1)	Nm	19,1 (15,9)	19,1 (15,9)
Cone	HSK	F63	F63

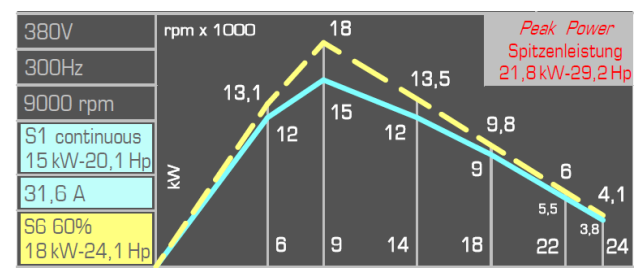

CNC TECHNOLOGY

The machine is supplied with the working desk toughened KARTIT. On special request we can supply cast iron working desk with T grooves or Al alloy working desk. Working desk from toughened KARTIT can be used for woodworking and plastic milling without cooling. In the case of the requirement for cooling is necessary to use working desk type: cast iron or aluminum alloy.

Technical parameters of working desks	
	Type of clamping
KARTIT working desk	Threads M10 in net 100 x 100 mm
CAST IRON working desk with T grooves	T grooves 22H8, pitch 250 mm
Al alloy working desk	Threads M10 in net 100 x 100 mm

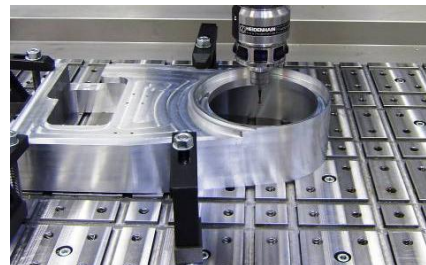
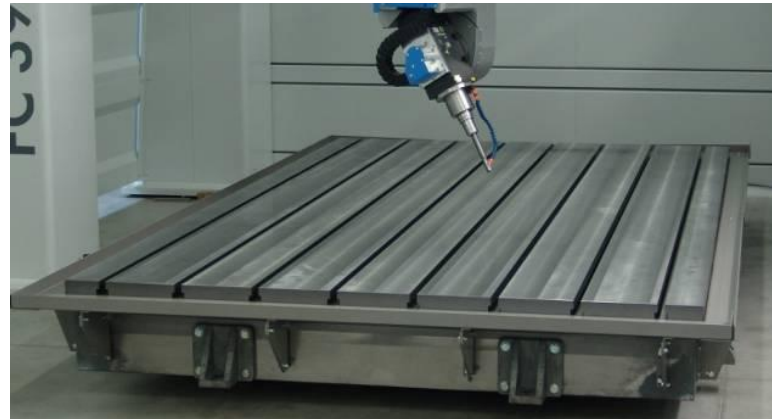
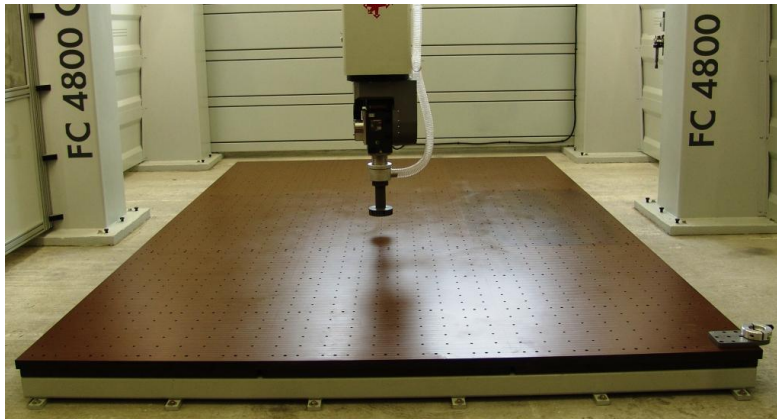



Exchange of tools can be realized in two ways. Hand tool exchange is suitable for production, where the instruments vary only at longer intervals (machining of wooden models and polystyrene). Automatic exchange is appropriate in all other cases. Part of the tool changer is software options for TOOL MANAGER by type of control system and its possibilities.

Technical parameters		AVN 12	AVN 44
Type of automatic tool changer		Rotary revolver	Chain with helping hand
Number of position		12	44
Max. diameter of tool	mm	190	200
Max. weight of tool	kg	5	5
Max. weight of all tools	kg	30	130
Time exchange	s	10	7
Time exchange (method chips-chips)	s	18	14

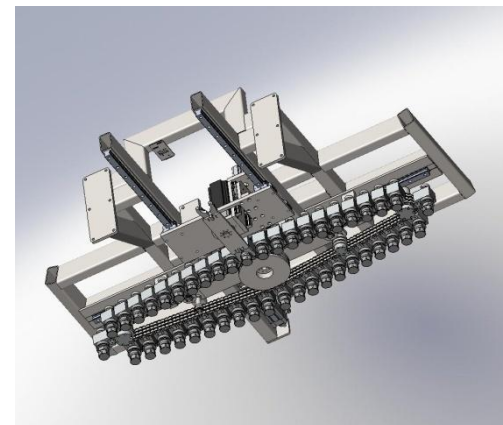
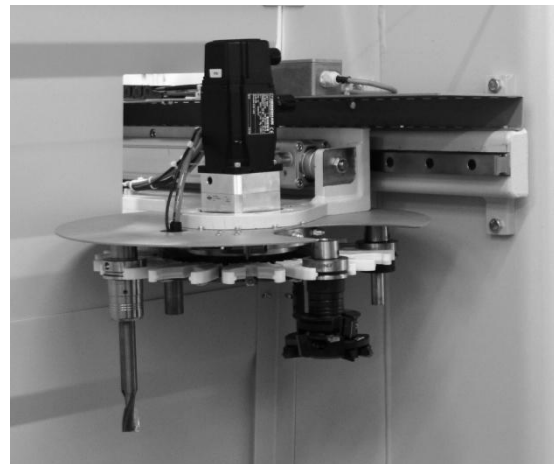



The machine is standard installed with control system HEIDENHAIN iTNC530. The special order can be supplied with the machine control system SIEMENS SINUMERIK 840D SL or FIDIA NC15. The choice of system depends on the particular qualifications of service and its practices.

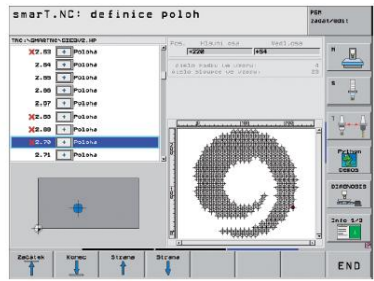
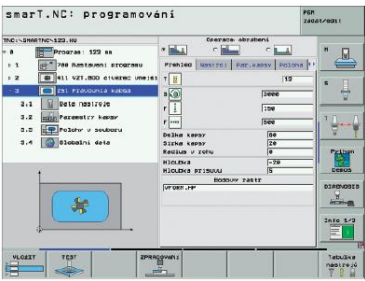

## Alternative controls system

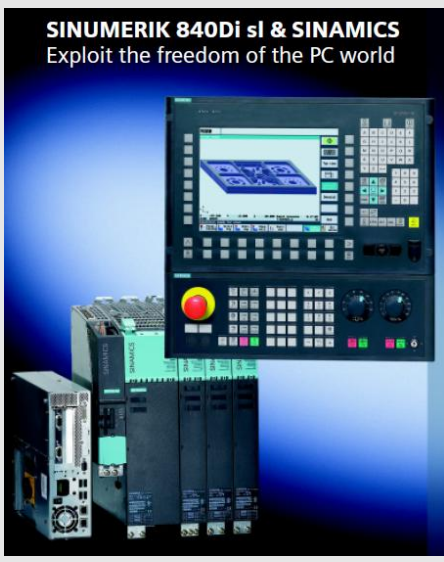

CNC TECHNOLOGY

In the following table lists is the basic dimensions of the machine and other parameters. Working stroke can be made arbitrarily within the limits listed in the technical parameters.

name	unit	FC.....CNC
Working stroke in axis X	mm	2000 - 50000
Working stroke in axis Y	mm	2000 - 6000
Working stroke in axis Z	mm	1000 - 3000
Max. movement in axis X/Y/Z	m/min	40 / 20 / 20
Servomotor axis X/Y/Z	Nm	13,5
Total lenght of machine in X	mm	2100 + stroke X
Total lenght of machine in Y	mm	2560 + stroke Y
Weight of machine	kg	by design
Total height of machine	mm	1730 + (2 x stroke Z) + w.table
Max. electrical power	kW	35
Voltage	V	400
Connection wire gauge	mm <sup>2</sup>	10
Frequency	Hz	50 / 60
Connection of compressed air	MPa	0,6 - 1,0

The machine can be manufactured in a version with a linear measuring system (precision production of machining aluminum alloys, production of patterns and molds) or a version without linear measuring system (cutting off plastics, composites, serial production of furniture parts, etc.). Choice depends on the precision requirements for production.

Accuracy of machine		Indirect measurement	Direct measurement
Repeatability movement on position X/Y/Z (one way)	mm	±0,03	±0,01
Repeatability movement on position X/Y/Z (two way)	mm	±0,06	±0,015
Repeatability movement on position A/C (one way)	"	30	---
Repeatability movement on position A/C (two way)	"	50	---
Distance traveled X/Y/Z (deviation from 1000 mm)	mm	±0,15	±0,02
Distance traveled A/C (deviation from 90°)	"	25	---
Acceleration X/Y/Z	m/s <sup>2</sup>	3	3
Acceleration A/C	°/s <sup>2</sup>	300	300

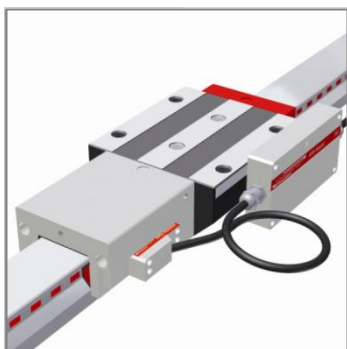

Direct measurement of the company SCHNEEBERGER is integrated directly in the rail system. By Laser "burned" marks along the rail line read when moving scanning head, which is an integral part of the wagons. Special electronics then process the signal and transmit control system.



## Minimizing time for production

The machine can be supplied with the tool (measuring tool length, diameter, radius) and the alignment probe (measurement and the establishment of the workpiece). Measurement functions are dependent on the type of control system. Support users and help to reduce idle times. The probes has many pre-standard cycles for automatic adjustment of the clamping of the workpiece, set the referencing point of machining, zero point, measuring instruments and the final measure machined parts.

**Compensating workpiece misalignment** by the rotating the coordinate system or turning the table

**Workpiece presetting.** You can use a reference point to assign a defined value to any workpiece position, for example on the corner of workpiece, in the middle of circle or arch and so on.

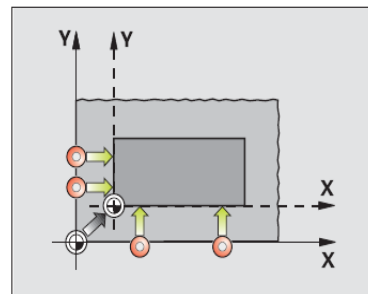
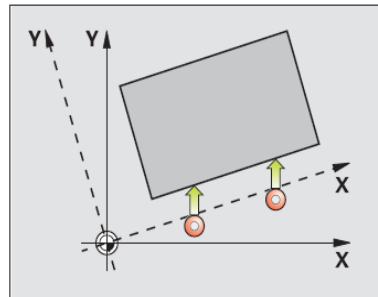

**The TT 140** tool touch probe captures the tool length directly in the machine's workspace. The tool touch probes are inserted directly into the machine tool spindle, simple by using the screw M8. We can do the tool measurement conduct by the rotating or standing tools, for example cutting edge measurement.

# Polystyrene machining



Productive machining of polystyrene with a special adapter for clamping tools with integrated suction.

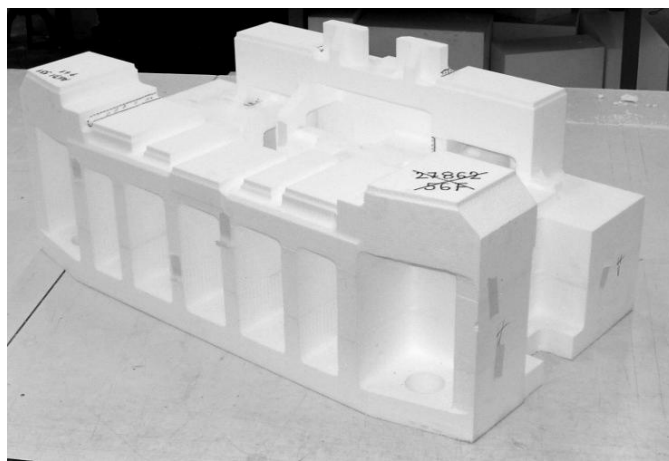
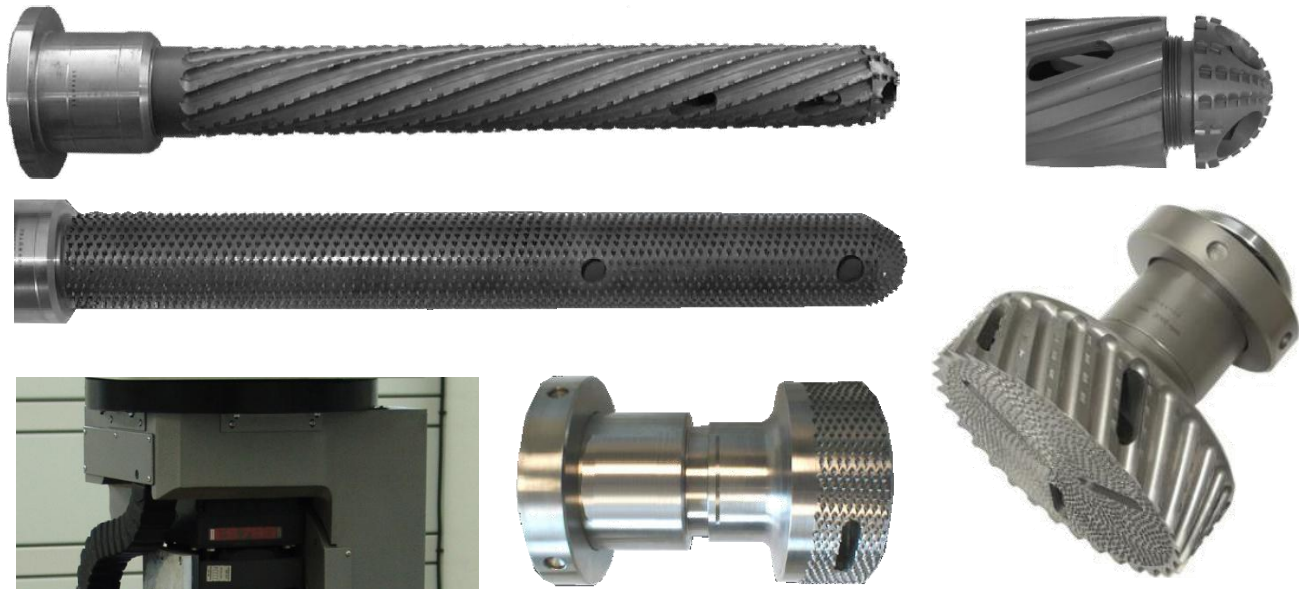

CNC TECHNOLOGY

For productive machining of aluminum alloys and some type of plastics, it is necessary to cool and grease the tool during machining. This requirement is realized an aggregate of oil aerosol (fog) or the traditional way i.e.. bring oil emulsion to the tool by the help of pump.



Tool cooling by oil fog is a modern method especially suitable for machining aluminum alloys. As the refrigerant is used rape-seed oil. Lubricating unit is spraying coolant using compressed air into a very fine oil fog. Fog is feed through nozzles directly to the cut. Despite a very small coolant use this method is very effective. Refrigerant consumption is about 4 liters per year at 8-hour work shift. Unit is located directly on the machine spindle.



Classic way to cool

The emulsion flows from the working table in a restraining tank with filtration pump where it is transported back to the instrument.





# Foundry pattern



CNC TECHNOLOGY



# Foundry pattern



CNC TECHNOLOGY

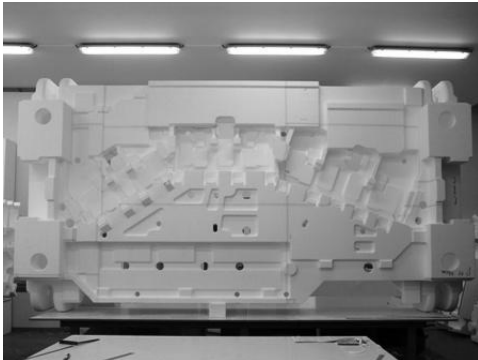

CNC TECHNOLOGY



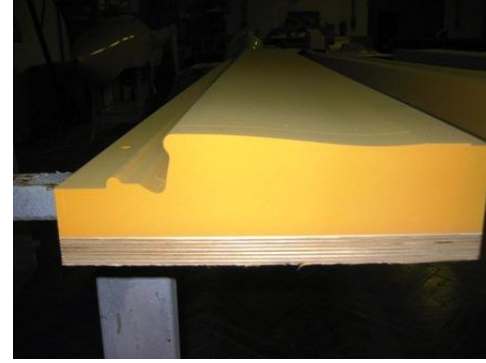

# Machining of plastic - composite

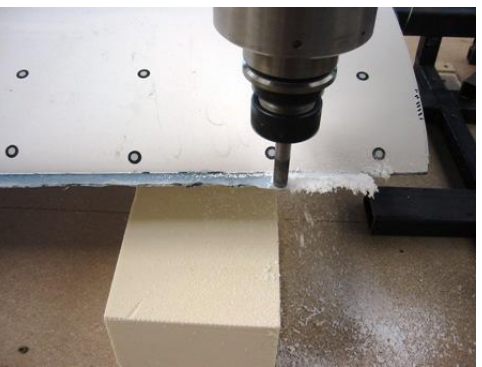
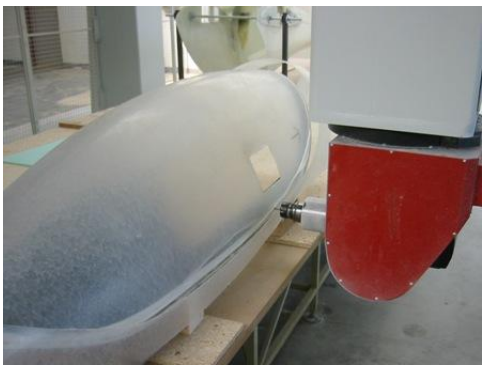

CNC TECHNOLOGY



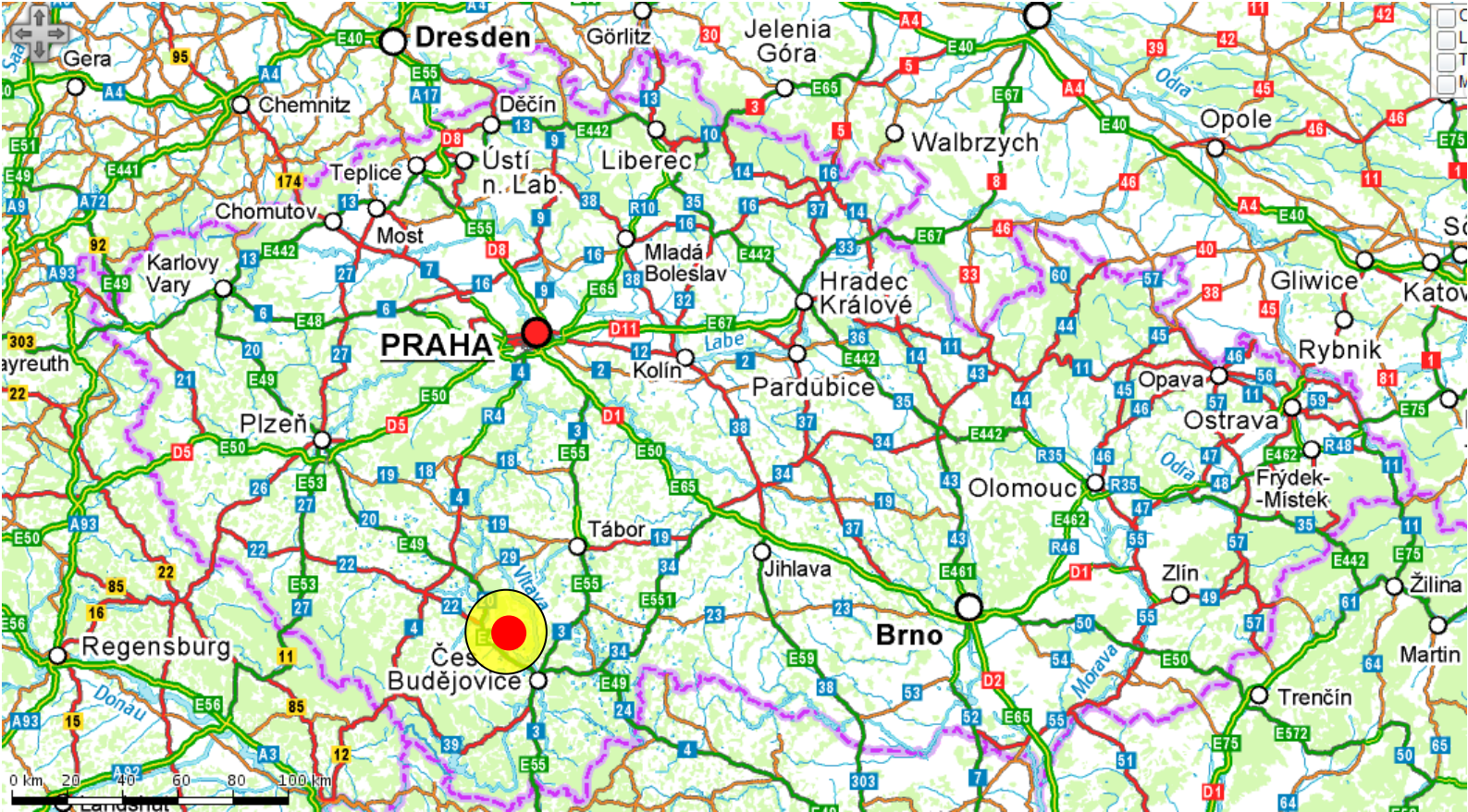

**SAHOS s.r.o.**  
Pištín 134  
37341 Hluboká nad Vltavou  
Czech Republic

phone/fax: +420 387 203 126  
e-mail: [sahos@sahos.cz](mailto:sahos@sahos.cz)  
URL: [www.sahos.cz](http://www.sahos.cz)

CNC TECHNOLOGY