



sandya

automatic wide belt sanders



scmsandya

A comprehensive answer to any working requirement

sandya 900

sandya 900

- 2 or 3 operating groups
- working width: 1350 mm

sandya 600

sandya 600

- 2 or 3 operating groups
- working width: 1100 and 1350 mm

sandya 300

sandya 300

- 1 or 2 operating groups
- working width: 950 and 1100 mm



SANDYA 900
page 04



sandya

The Sandya wide belt sander range consists of models 300, 600 and 900 and is able to **satisfy any calibrating and sanding requirement** due to the wide availability of technological solutions allowing the creation of very customised machine configurations.



SANDYA 600
page 10

SANDYA 300
page 14

SANDYA 95 EVO

SANDYA 15



sandya

sandya 900

the best performance for a higher level of competitiveness



AVAILABLE VERSIONS

It is available with nine versions, and with two or three main operating groups, in which it is possible to accommodate a planer unit in the 1st position, substitute the pad unit with a **superfinishing unit**, and add a complete range of devices for the work table and the presser units

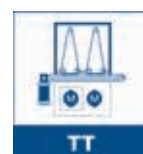

The Sandya 900 is the correct choice for medium to high level industrial companies that require **diversified machining** with a **high level of finishing quality** and it satisfies all calibrating and sanding requirements, by offering a wide range of technological solutions allowing the possibility of **customising the machines compositions**.



SANDYA 900		I35
Working width	mm	1350
Min/max thickness to be machined (with mobile table)	mm	4 / 170
Min/max thickness to be machined (with fixed table)	mm	4 / 200
Sanding belts width/length (with fixed table)	mm	1370 / 2620
Standard main motor power (2 groups version)	kW (hp)	11 (15)
Standard motor power - 1st group (3 groups version)	kW (hp)	11 (15)
Standard motor power – 2nd group (3 groups version)	kW (hp)	11 (15)
Feed belt speed	m/min	4,5 / 9

sandya 900

versatility, high rate of production and a quality finish



RCS VERSION

It provides, with a reduced investment, the best performance of a high level machine and the versatility of a multifunctional configuration.

The characteristics of this version allows **different operations on solid wood calibrating and sanding veneered, lacquer and painted panels** with a high degree of finishing and optimum production levels.

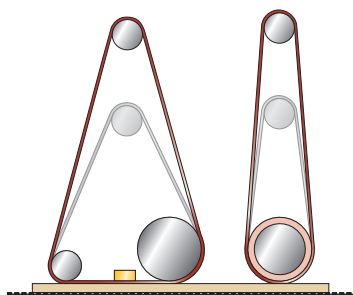

LONG BELTS: 2.620 MM LENGTH FOR GREATER FINISHING AND PRODUCTIVITY

Better cooling of the abrasive grit due to the greater development of the belts that reduces the adherence of processed dust. An extended belt length lasts longer, requires fewer replacements and consequently less downtime.

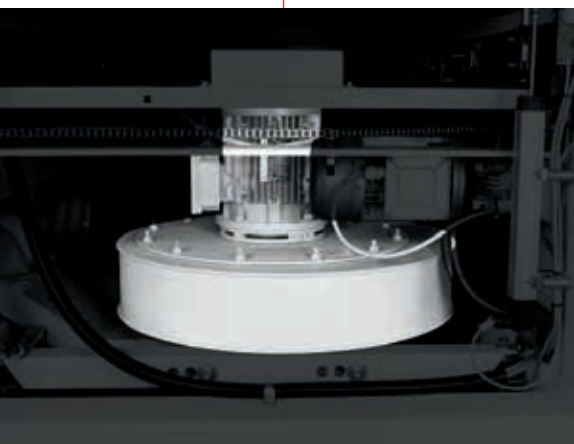

toptech

INTEGRATED ELECTRO-FAN: GIVING EXTREME COMPACTNESS

Reduced overall dimensions and noise emissions with the fan positioned under the work table.

sandya 900

versatility, high rate of production and a quality finish

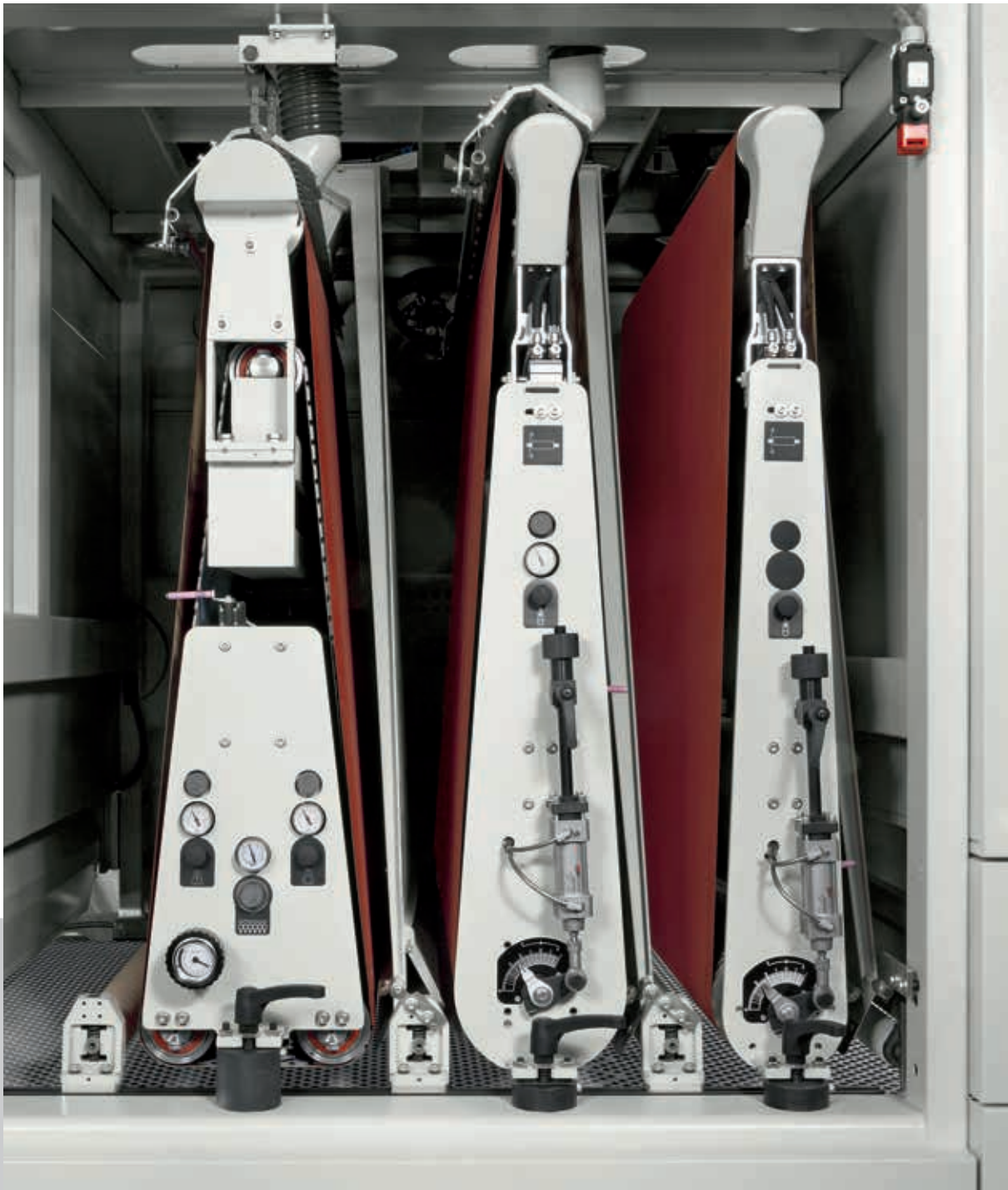

RRT VERSION

This configuration with a calibrating roller, large diameter sanding roller and a superfinishing pad provides perfect satisfaction for any **production and finishing requirement on rough and lacquered panels** of an industrial company and particularly demanding for those who want to combine **productivity and quality**.



toptech

**SUPERFINISHING UNIT:
FOR SANDING AT THE HIGHEST LEVEL**

Uniform finish with the chevron belt which improves the cooling of the abrasive action on the work piece, the wide contact surface and the copying capacity of the “MESAR” electronic pad.

The unit is particularly suitable for the superfinishing of solid wood components, MDF panels that have been laminated, veneered or painted (opaque and polished).

It is the ideal choice for all companies who require the highest finishing level on “hi-gloss” panels.

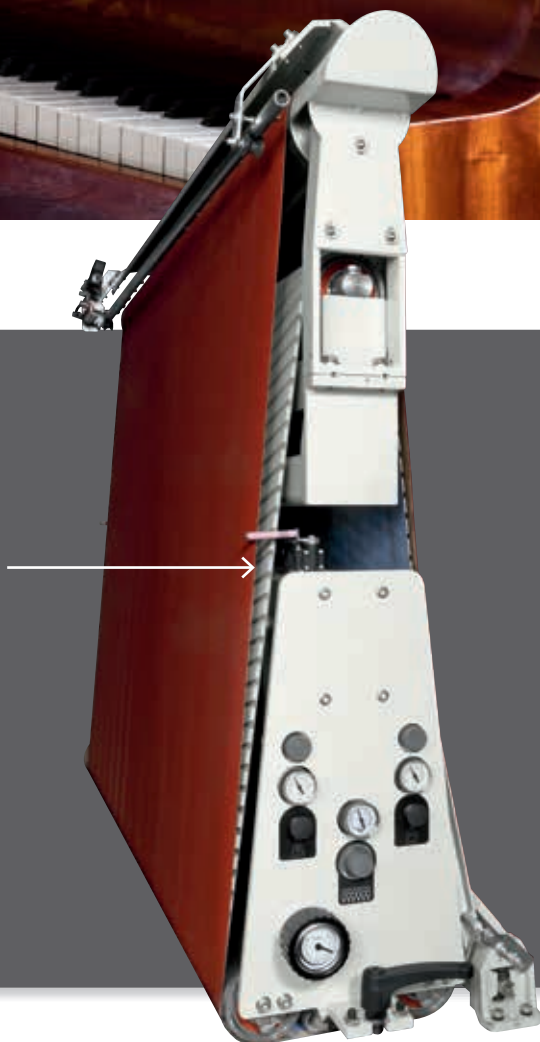

sandya 600

accuracy and performance that lasts forever



AVAILABLE VERSIONS





The sandya 600 is now more robust with an ergonomically designed base, **increased motor capacities, calibrating/sanding rollers among the largest available within its category**, and very precise sanding pads, so it is now able to satisfy all requirements of companies that would like to grow in a more and more competitive market place.



SANDYA 600		110	135
Working width	mm	1100	1350
Min./max. working thickness	mm	4 / 170	4 / 170
Sanding belts width/length	mm	1115 / 2150	1370 / 2150
Standard main motor power (2 groups version)	kW (hp)	11 (15)	11 (15)
Standard motor power – 1st group (3 groups version)	kW (hp)	11 (15)	11 (15)
Standard motor power – 2nd group (3 groups version)	kW (hp)	11 (15)	11 (15)
Feed belt speed	m/min	4,5 / 9	4,5 / 9

sandya 600

sturdiness and high performance for many and diversified production requirements



RR VERSION

This version is perfect for operations where **heavy stock removal rates** are required or where users have to machine **narrow work pieces or any type of frame**. The large dimensioned sanding roller guarantees the very **best finishing** even on **veneered and painted surfaces**.



RRCS VERSION

The availability of 3 sanding groups ensures high flexibility and time saving and ensures this version is perfect for both calibrating and sanding operations of large dimensioned panels. In the furniture sector (with veneered, lacquered and painted panels) it excels in the provision of an **optimum level of finishing** due to the “Mesar” electronic sectional pad.

sandya 300

designed for advanced woodworking companies and veneer sanding operators



AVAILABLE VERSIONS

It is available with 950 and 1100 working widths and can accommodate 1 or 2 operating groups in order to ensure a high degree of flexibility.



Compact machine with superior technical features, Sandya 300 is the perfect solution for small woodworking companies who would like to satisfy all **solid wood calibrating, sanding and the sanding of veneered panels.**



SANDYA 300		95	110
Working width	mm	950	1100
Min./max. working thickness	mm	4 / 170	4 / 170
Sanding belts width/length	mm	970 / 1900	1115 / 1900
Standard main motor power	kW (hp)	11 (15)	11 (15)
Feed belt speed	m/min	4,5 / 9	4,5 / 9

sandya 300

superior technical features

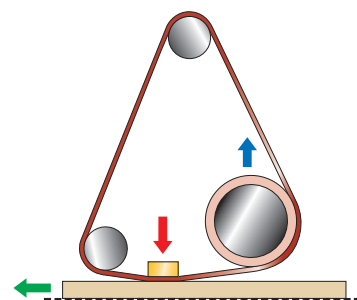

Sanding with pad

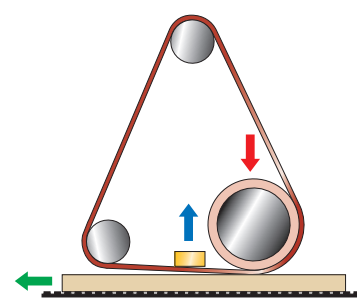

Calibrating / sanding with roller

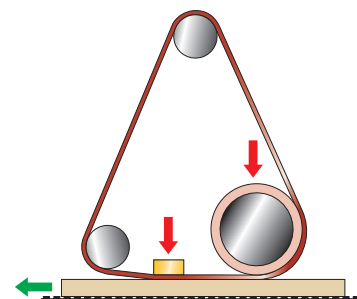

Calibrating / sanding with roller
and sanding with pad

CS VERSION

The CS combined group is the secret of the Sandya 300's flexibility. The possibility to use the roller and the pad either simultaneously or independently of one another provides **high quality results**.



RCS VERSION

Higher flexibility and productivity for a **top quality finishing in a single passage.**

Ideal for all "typical" requirements of woodworking and veneering companies: solid wood calibrating/sanding and sanding veneered panels (internal doors, windows and customised furniture). The combination of using only the roller groups gives optimum results when sanding against the grain. The models with 1.100 mm working width, with the availability of the electronic sectional pad also provide the machining and sanding of honey-comb veneered panels.

sandya

calibrating sanding group

The calibrating and sanding roller is available with roller diameters of 160, 200, 250 and 320 mm with grooved steel or a rubber coating option.

Rubber -coated roller

The wide range of hardness (from 85 to 20 sh) enables the roller to obtain excellent results from the most aggressive sanding to the most delicate operations on veneered and painted panels.



Grooved steel roller

It provides the maximum precision on heavy calibrating operations, even on wood with a differentiated grain and knotted solid wood.



Diameter (mm)	SANDYA 300	SANDYA 600	SANDYA 900
120	•		
140		•	
160		•	
175		•	•
220			•
250		•	•
320			•

sandya

pad units



toptech

“MESAR” ELECTRONIC SECTIONAL PAD: THE BEST FINISH WITH ANY MATERIAL

Higher quality results due to the special shape of the sectors that allows the operator to intervene “softly” but also in an “aggressive” way, simply by varying the working pressure. The setting of the pad position and the possibility of using foils of different thicknesses increases its versatility.

A line of sensors detecting the work piece profile, automatically controls the electronic pad intervention thus avoiding any possible damage when machining.

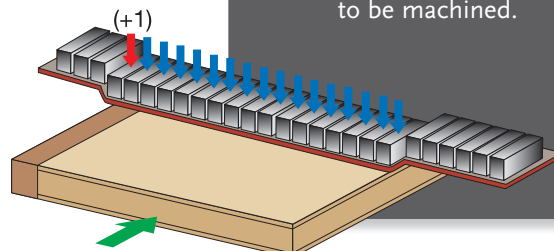
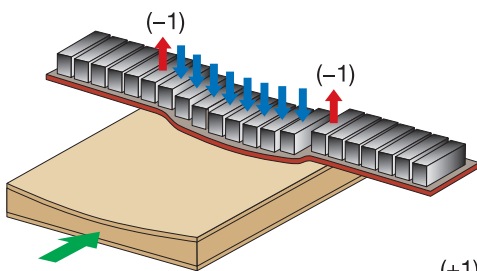
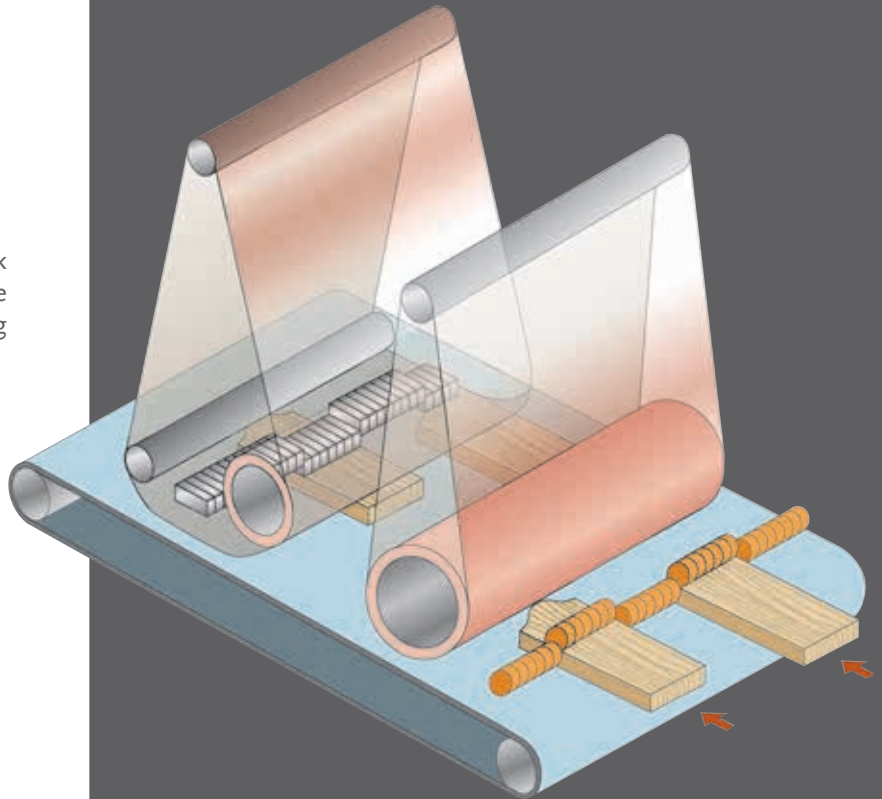

To sand convex, concave and/or solid wood panels, it is possible to add or remove, directly from the control panel, one or more sectors along the side edges of the work piece to be machined.



ELASTIC SECTIONAL PAD

Thanks to its capacity of adapting the irregular surfaces, the TES can be used for veneered panels sanding, even when they are not perfectly flat.

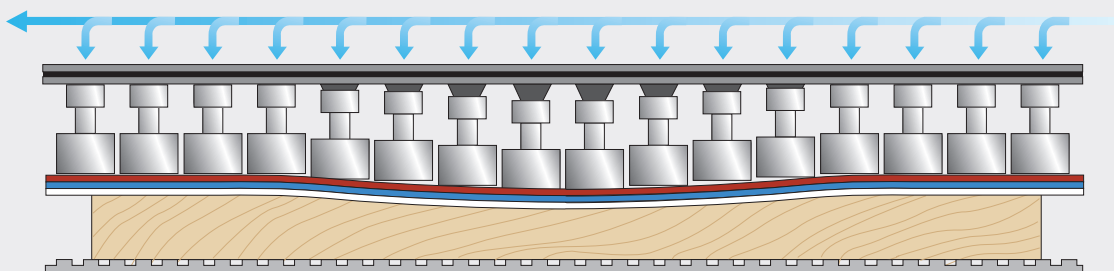

EXTRACTABLE STIFF PAD

Excellent solid wood finishing with the extractable stiff pad.

Possibility to add the semi-stiff pad when sanding veneered panels (option). The rapid extraction system allows easy interchangeability of the inserts for a rapid changeover.

sandya

planer group



toptech

“HPL” PLANER GROUP: MAXIMUM REMOVAL COUPLED WITH MAXIMUM SAVINGS.

One single pass to perform heavy material removal with the absorption of low power; a degree of finish comparable to 4 abrasive belts due to the helicoidal positioning of the knives mounted on the group.



The easy access allowed by the exclusion of the infeed rollers simplifies maintenance operations. (option).

The anti-kickback fingers, the heavy sectional bar and the micro switch for too thick components set on the pressure roller, makes it absolutely safe when employing the HPL planer group, even for an unskilled operator.

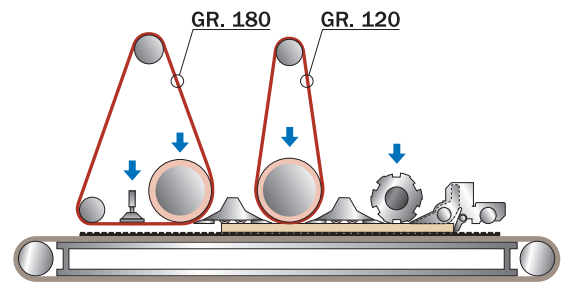
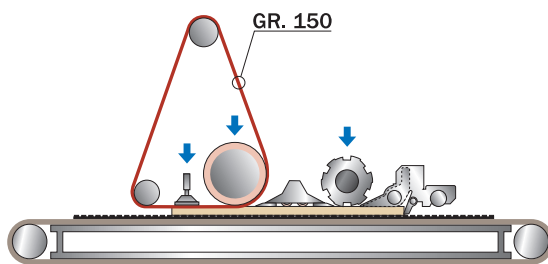

After planing, the surface of the panel needs only a slight degree of finishing. This can be done with a 150 grit sanding belt using a single operating unit or a 180 grit sanding belt using two operating units.

finishing groups

**Buffing unit**

It provides a perfect finish and a smooth panel surface before final painting.

**Structuring unit**

It gives the panel a rustic or weathered look, particularly recommended for period furniture.

sandya

other devices

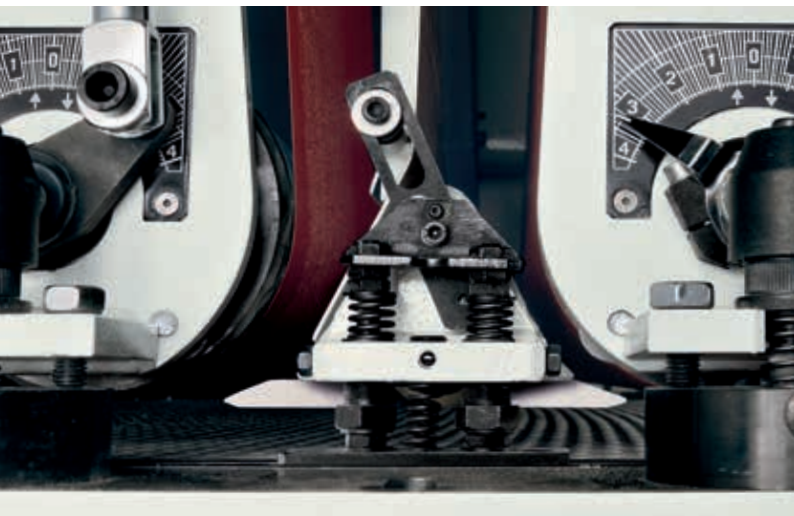

Floating pressure shoes: the best finishing of solid wood

The particular design of the pressure shoes greatly reduces the centre-to-centre distance during sanding. This feature guarantees a higher but more uniformly distributed hold-down pressure when calibrating solid wood with high stock removal and the sanding of short, narrow and uneven components.

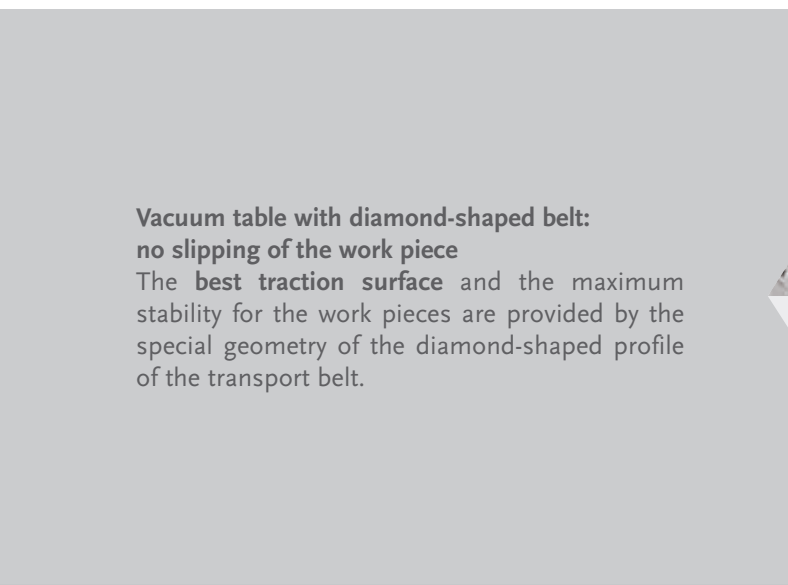

Vacuum table with diamond-shaped belt: no slipping of the work piece

The **best traction surface** and the maximum stability for the work pieces are provided by the special geometry of the diamond-shaped profile of the transport belt.

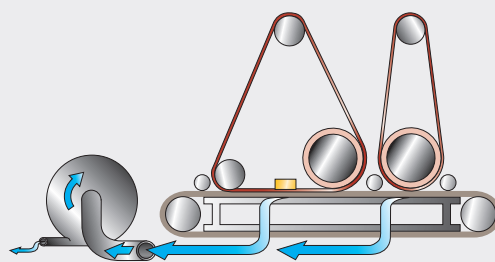

Rotating blowers

The **rotating blowers** gently removes dust from sanded components. To reduce the consumption of compressed air to a minimum, the unit operation is timed and the blowers only operate when a component is present in the machine.





Timed oscillating belt cleaning blower

Electronically controlled timing and only when a component is present in the machine guarantees **reliability** over time and **reduces compressed air consumption to a minimum**. Particularly advisable when machining painted work pieces.

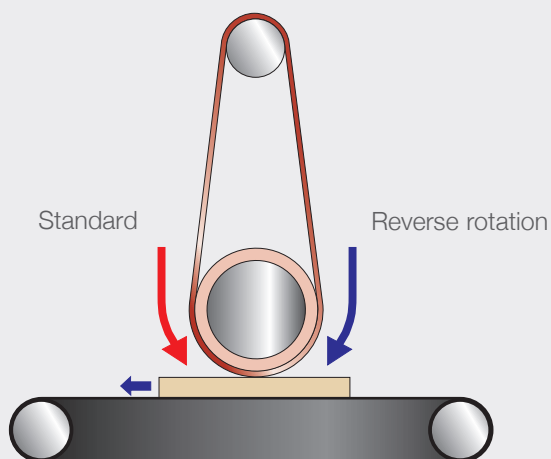

Reverse rotation of the sanding belt: ideal for water-based paints

With dedicated exhaust hoods this is the perfect solution for solid wood pre-sanding (removes any fibres that remain following calibration) and very delicate sanding operations.

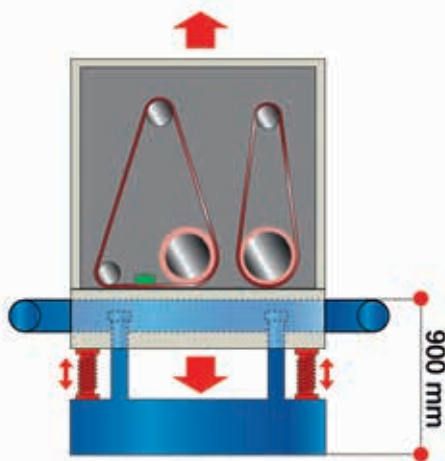

Worktable at fixed height: ease of use

The version with 900 mm fixed height worktable allows the roller conveyors or belt transfer units to be positioned at the machine infeed and/or outfeed, to facilitate the machining of long and heavy work pieces.

sandya

other devices

Automatic table positioning: practicality and precision together

The automatic detection of the work piece thickness allows precise machining at all times and without the risk of operator error. The decimal setting of this system also allows setting the work depth independently of the material.



Belt oscillation controlled by an electronic photocell

This precision control system ensures the maximum uniformity in belt oscillation: this reduces the risk of belt breakage and improves finishing quality.



Automatic feed belt tensioning and centring: for an easy operation

An electro-pneumatic system keeps the feed belt on track, perfectly centred and tensioned at all times. The system is automatic and no operator intervention is required.



Led indicator for panel introduction

Simple and intuitive, communicating to the operator where and when the panel has to be introduced into the machine and optimising the standard wear of the sanding belt; this ensures a **better quality finish and reduced machine costs**.



sandya

electronic controls



LOGIC TS" ELECTRONIC PROGRAMMER: TECHNOLOGY TO YOUR SERVICE

Powerful and reliable, it is fitted with a touch-screen making all machine functions quick and easy to operate.

- LCD colour display, size 5,7 or 10,4 inches
- 120 working programs



toptech

"LOGIC SC" ELECTRONIC PROGRAMMER: EASILY AVOIDING MISTAKES

Simple and intuitive, allowing the operator to set all processing parameters in sequence and then launch them with the touch of a button. The possibility to store various work programs to retrieve the machine settings most commonly used makes it ideal even for unskilled operators.



"LOGIC 50" ELECTRONIC PROGRAMMER: EASY-TO-USE

It controls an electronic sectional pad in addition to pads and rollers, for machines with variable feed speed.

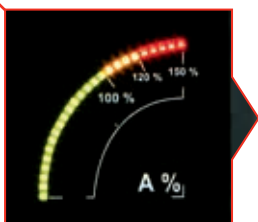

DIGITAL AMMETER

It allows an easy and immediate visualization of the main motors power absorption.

A VERSION

For rapid work changeover

Ideal for generic solid wood applications

- ▶ On-off pneumatic selector for rollers
- ▶ On-off pneumatic selector for pad
- ▶ Electronic positioning for working table

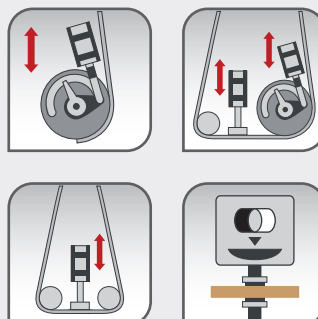

B VERSION

For perfect finishing

Solid wood/veneered applications

- ▶ On-off pneumatic selector for rollers
- ▶ On-off pneumatic selector for pad
- ▶ Electronic positioning for working table
- ▶ Elastic sectional pad
- ▶ Logic 50 K electronic programmer

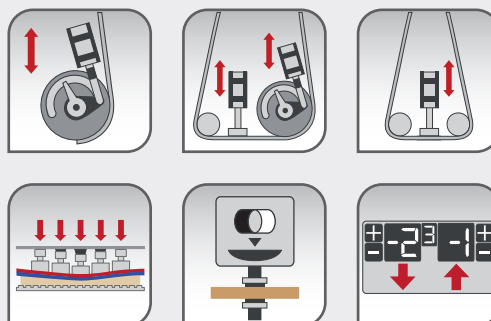

C / C-PLUS VERSION

Full range of options for all sanding operations

Solid wood/veneered applications and also on honeycomb panels with irregular shapes

- ▶ On-off pneumatic selector for rollers
- ▶ On-off pneumatic selector for pad
- ▶ Electronic positioning for working table
- ▶ Elastic sectional pad
- ▶ Logic 50 K electronic programmer

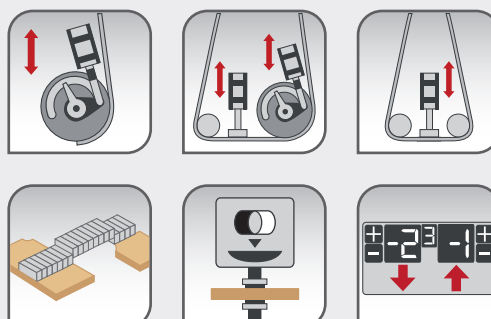

sandya

overall dimensions

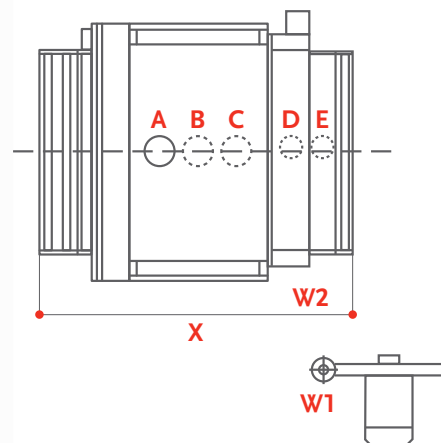

MACHINE DIMENSIONS (mm)

	sandya 300		sandya 600		sandya 900	
	95	110	110	135	135	Working width
X	1820	1820	1920	1920	2190	version with 1 or 2 groups
X	-	-	2190	2190	2580	version with 3 groups
Y	1500	1650	1650	1900	1900	
Z	1960	1960	2030	2030	2390	machine with mobile table
Z	-	-	-	-	2390/2590	machine with fixed table (min./max.)

HOODS DIAMETER (mm)

	sandya 300		sandya 600		sandya 900	
	95	110	110	135	135	Working width
A	140	140	160	195	195	first group
B	140	140	160	195	195	second group
C	-	-	160	195	195	third group
D	-	-	160	160	160	brushing group – rotating blower
E	-	-	160	160	160	rotating blower
w1	-	-	66	66	-	internal vacuum
w2	-	-	-	-	150	external vacuum

Noise levels according to the reference standard EN 1218-4:2004* A2:2009

scm
 minimax
 scm tecmatic

scm
 routech
 celaschi
 dmc
 superfici
 sergiani
 gabbiani
 morbidelli
 mahros
 stefani
 cpc
 sag
 scmgroup
 delmac
 scmfonderie
 steelmec
 hiteco
 es
 csr

CMS Cms
 wood technology

CMS Cms
 advanced materials technology

CMS Brembana
 stone technology

CMS Brembana
 glass technology

CMS CmsPlast
 plastic technology

CMS Tecnocut
 waterjet technology

CMS Balestrini

1 large integrated group
 18 production sites
 29 specialist brands
 19 foreign branches
 more than 50 years in business
 80% exports
 350 agents and distributors
 390 registered patents
 500 engineers
 3.000 square metres of showroom
 10.000 classical and professional
 machines manufactured per year
 240.000 square metres of
 production space

scm group
 passion technology performance



www.scmgroup.com/qrcode/v1



www.scmgroup.com/it/mission_scm



The technical data can vary according to the requested machine composition. In this catalogue, machines are shown with options. The company reserves the right to modify technical specifications without prior notice; the modifications do not influence the safety foreseen by the CE Norms.



SCM GROUP SPA SCM

sales offices: via Casale, 450 - 47826 Villa Verucchio, Rimini - Italy

tel. +39 0541 674111 - fax +39 0541 674274 - scm@scmgroup.com - www.scmgroup.com



00L0220698G