





Mikra 2400





Mikra 2400

 Encoladora de cantos para melamina, chapa, PVC, fórmica y PVC-ABS. Espesores cantos desde 0,3 hasta 3 mm.

 Edge Bander fot melamine, tole, PVC, formica and PVC ABS. Thickness of banding material from 0,3 to 3 mm.

 Plaqueuses de chantos pour mélamine, tôle, PVAc ABS. Epaisseur du chant de 0,3 jusqu'a 3 mm.

 Kantenanleimmachinen für melamin, folienholz, PVC, formica und PVC/ABS. Anleimerdicke 0,3-3 mm.

 Bordatrici per melaminico, impiallaccatura. PVC, Formica, PVC/ABS rigido. Spessore del bordo 0,3-3 mm.

 適用於黏貼密紋飾膠片, PVC片, 福米卡(商標, 原文FORMICA) 耐熱強膠片及PVC-ABS之木料邊角上膠機。邊角厚度可為0.3至3mm。

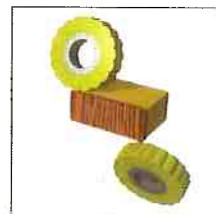
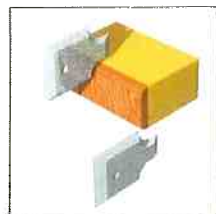
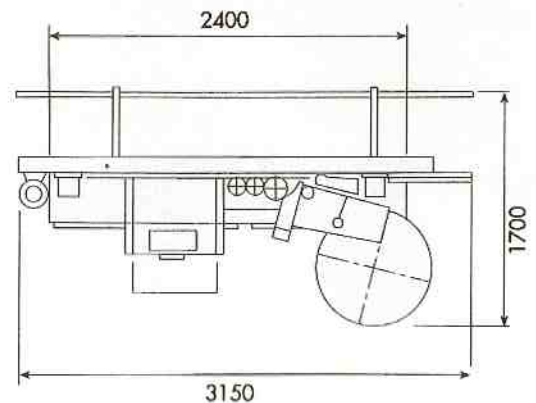





Mikra 2700





Mikra 2700

 Encoladoras de Cantos para melamina, chapa, PVC, fórmica, PVC/ABS y listones de madera hasta 10 mm.

 EDGE BANDER for melamine, veneer panel, PVC, formica, PVC ABS and wood strip 10 mm.

 PLAQUEUSES de chants pour mélamine, tôle, PVaC, formica, PVaC/ABS et alèses à bois 10 mm.

 Kantenanleimmaschinen für melamin, folienholz, PVC, formica, PVC/ABS und massivholz bis 10 mm.

 Bordatrici per melaminico, impiallacciatura, PVC, formica, PVC/ABS rigido e masello fino a 10 mm.

 適用於黏貼蜜梨型膠片, PVC片, 福米卡耐熱塑膠片, PVC/ABS及厚度可達10mm的木條之木料邊角上膠機。

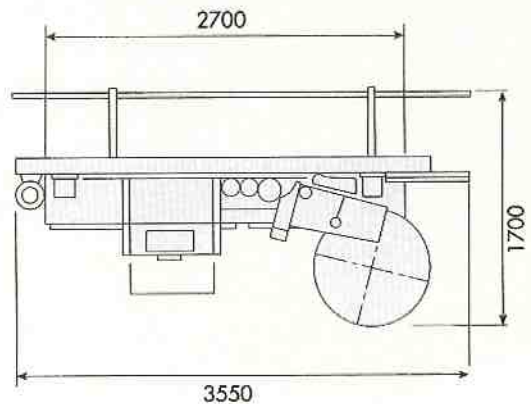









Mikra 3100



Mikra 3100

-  Encoladora de cantos para melamina, chapa, PVC, fórmica y PVC-ABS. Espesores cantos desde 0,3 hasta 3 mm.
-  Kantenleimmachinen für melamin, folienholz, PVC, formica und PVC/ABS. Anleimerdicke 0,3-3 mm.
-  Edge Bander fot melamine, tole, PVC, formica and PVC ABS. Thickness of banding material from 0,3 to 3 mm.
-  Bordatrici per melaminico, impiallacciatura. PVC, Formica, PVC/ABS rigido. Spesore del bordo 0,3-3 mm.
-  Plaqueuses de chants pour mélamine, tôle, PVAc ABS. Epaisseur du chant de 0,3 jusqu'a 3 mm.
-  適用於黏貼蜜紋塑膠片, PVC片, 福米卡(商標, 原文FORMICA) 耐熱塑膠片及PVC-ABS之木料邊角上膠機. 邊角厚度可為0.3至3mm.

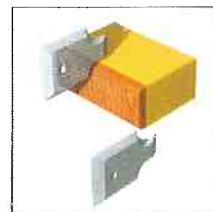
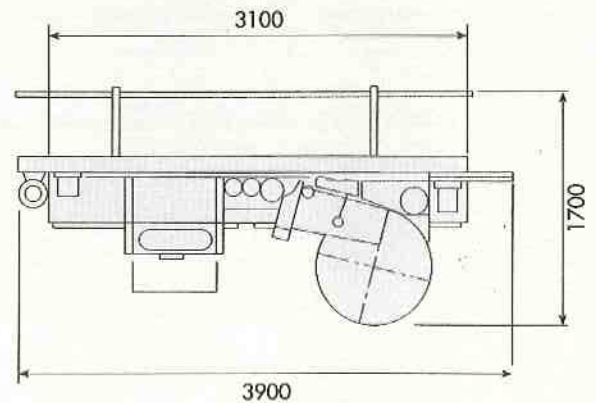



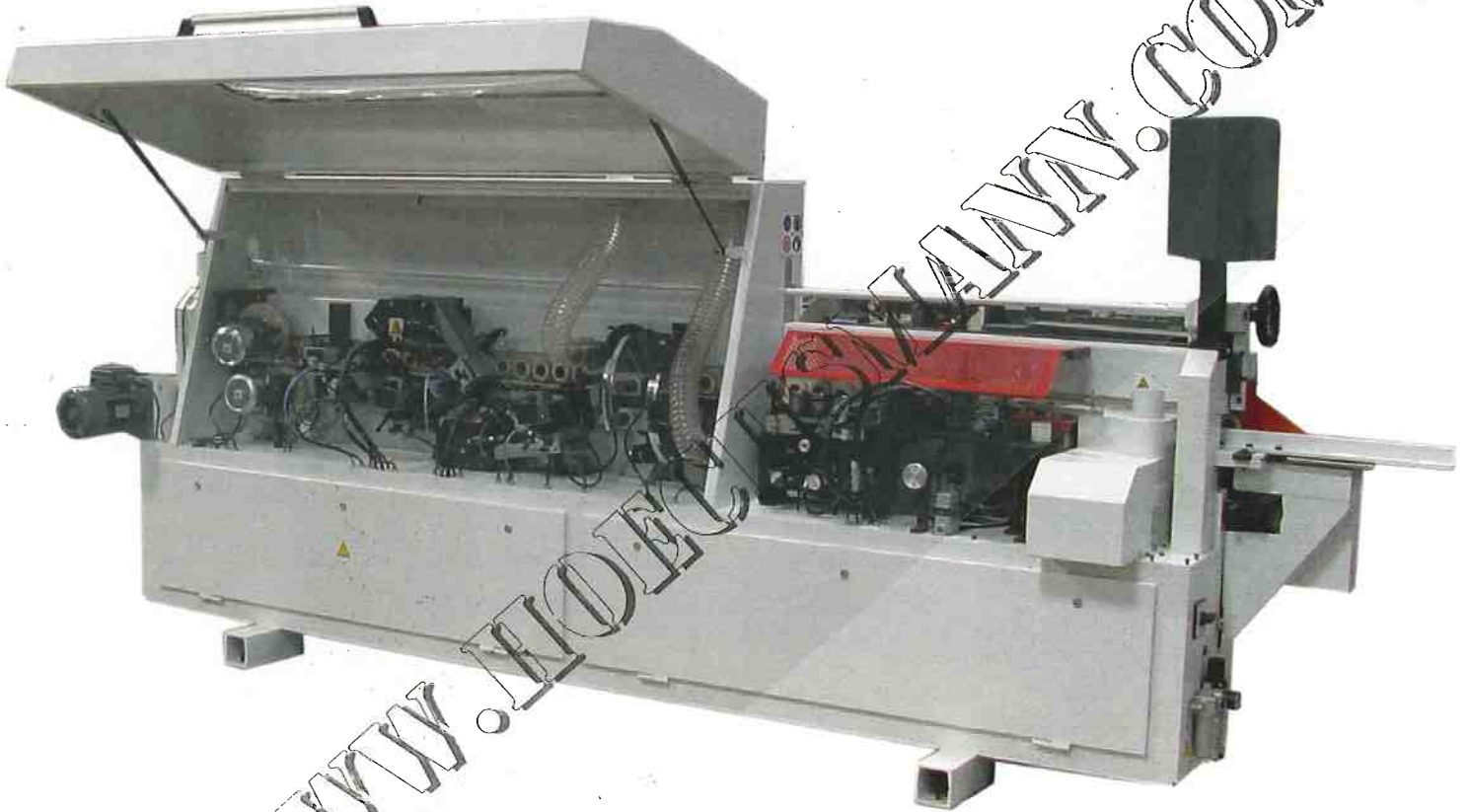

Mikra 3500





Mikra 3500

 Encoladora de cantos para melamina, chapa, PVC, fórmica y PVC-ABS. Espesores cantos desde 0,3 hasta 3 mm.

 Edge Bander for melamine, tole, PVC, formica and PVC ABS. Thickness of banding material from 0,3 to 3 mm.

 Plaqueuses de chants pour mélamine, tôle, PVAc ABS. Epaisseur du chant de 0,3 jusqu'a 3 mm.

 Kantenanleimmachinen für melamin, follenholz, PVC, formica und PVC/ABS. Anleimerdicke 0,3-3 mm.

 Bordatrici per melaminico, impiallacciatura. PVC, Formica, PVC/ABS rigido. Spessore del bordo 0,3-3 mm.

 適用於黏貼密紋膠片, PVC片, 福米卡(商標, 原文FORNICA) 耐熱塑膠片及PVC-ABS之木料邊角上膠機. 邊角厚度可為0.3至3mm.

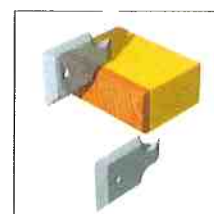
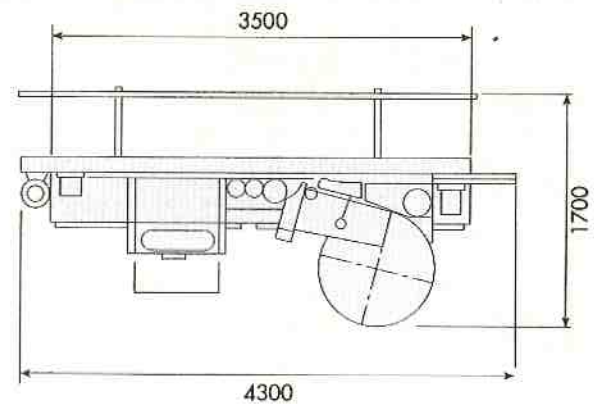



Mikra 4500



Mikra 4500

Encoladora de cantos para melamina, chapa, PVC, fórmica y PVC-ABS. Espesores cantos desde 0,3 hasta 3 mm.

Kantenanleimmachinen für melamin, folienholz, PVC, formica und PVC/ABS. Anleimerdicke 0,3-3 mm.

Edge Bander fot melamine, tole, PVC, formica and PVC ABS. Thickness of banding material from 0,3 to 3 mm.

Bordatrici per melaminico, impiallacciatura. PVC, Formica, PVC/ABS rigido. Spessore del bordo 0,3-3 mm.

Plaqueuses de chants pour mélamine, tôle, PVAc ABS. Epaisseur du chant de 0,3 jusqu'a 3 mm.

適用於粘貼蜜胺膠片, PVC片, 福米卡(商標, 原義FORMICA) 耐熱膠片及PVC-ABS之木料邊角上膠機. 邊角厚度可為0.3至3mm.

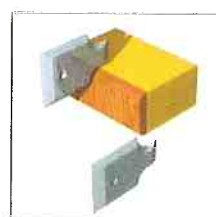
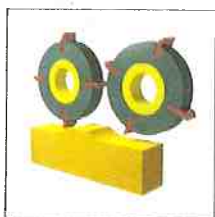
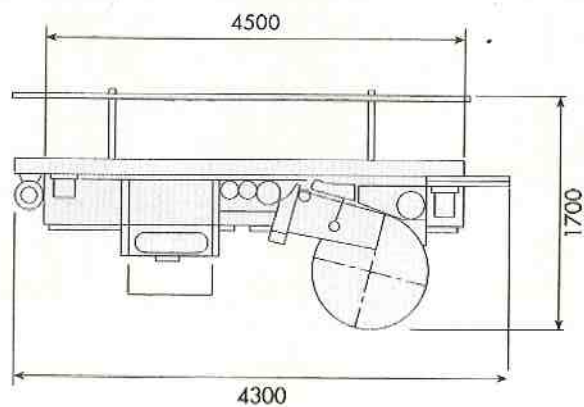

RETORNO



RETORNO

 RETORNO automático de piezas para encoladoras de cantos.

 AUTOMATIC BOOMERANG for edge bander.

 RETOUR AUTOMATIQUE pour plaqueuses de chants.

 AUTOMATISCHE "BOOMERANG" für kantenleimmaschinen.

 RITORNO AUTOMATICO per Bordatrici.

 木料邊角上膠機用部件自動回程車



**MODEL
OLIMPIC**

CARACTERÍSTICAS TÉCNICAS	TECHNICAL SPECIFICATIONS	CARACTERISTIQUES TECHNIQUES	TECHNISCHE DATEN	CARATTERISTICHE TECNICHE	
Altura de trabajo	Glueing heigt	Hauteur d'encollage	Anlemer höhe	Altezza lavoro	
- Mínimo	- Minimum	- Minimum	- Minimum	- Minima	10 mm
- Máximo	- Maximum	- Maximum	- Maximum	- Massima	45 mm
- Opcional	- Options	- Options	- Option	- Opzione	55 mm
Espesor Canto	Thickness of banding material	Epaisseur du chant	Anleimerdicke	Spessore del bordo	
- Mínimo	- Minimum	- Minimum	- Minimum	- Minimo	0,4 mm
- Máximo	- Maximum	- Maximum	- Maximum	- Massimo	3 mm
- Opcional	- Options	- Options	- Option	- Opzione	10 mm
Ancho mínimo de trabajo	Working width minimum	Largeur minimum de travail	Anleimerbreite minimum	Larghezza minima di lavoro	80 mm
Largo mínimo de trabajo	Panel minimum length	Longueur minimum de travail	Anleimerlänge minimum	Lunghezza minima di lavoro	120 mm
Velocidad moto-reductor	Feed speed	Vitesse d'avancement	Vorschubgeschwindigkeit	Motoriduttore	6-12 mts x min
Moto variador regulable opcional	Adjustable feed speed option	Vitesse d'avancement variable. Option	Regelbare Option Vorschubgeschwindigkeit	Motovariatore regolabile in opzione	6-18 mts x min.
Convertidor alta frecuencia	High frequency converter	Convertisseur haute fréquence	Frequenzumformer	Convertitore alta frequenza	200 Hz
Aire comprimido	Compressed air	Air comprimé	Druckluftanschluss	Aria compressa	6/7 ATM
Largo total máquina según modelo	Total machine length	Longueur totale de la machine	Maschinenlänge je nach Modell	Lunghezza totale della macchina	M2400 3150 mm M2700 3550 mm M2800 3550 mm M3100 3900 mm M3500 4300 mm
Ancho total de la máquina	Total machine width	Largeur totale de la machine	Maschinen breite gesamt	Larghezza totale della macchina	800 mm
Altura total de la máquina	Total machine height	Hauteur totale de la machine	Maschinen höhe gesamt	Altezza totale della macchina	1500 mm
Altura total con cabinas abiertas	Machine height with protection cabin opened	Hauteur totale avec cabinas ouvertes	Maschinen höhe gesamt bei geöffneten Kabinen	Altezza totale con cabina aperte	2000 mm
Tensión normal de conexión	Operating standard voltage	Alimentation électrique	Regelrichtspannung	Voltaggio	380V. 50 Hz
Diámetro bocas aspiración	Outlets for connection extraction	Buses de raccordement à l'installation d'aspiration	Anschlussutzen	Diámetro bocche di aspirazione	80-95 mm
Peso aproximado de la máquina	Weight	Poids de la machine	Maschinen gewith	Peso approssimativo della macchina	M2400 1.100 Kgs M2700 1.150 Kgs M2800 1.150 Kgs M3100 1.200 Kgs M3500 1.300 Kgs.

Las medidas, peso y datos técnicos de los manufacturados deben ser considerados -indicativos y no son vinculantes. La empresa se reserva el derecho de efectuar modificaciones sin aviso alguno sin que ello afecte a la calidad de la máquina.

Measures, weights and technical datas of the products must be considered approximate and not binding. We reserve the right to make modifications without prior notice provided the overall capacity and value of the equipment remain unchanged.

Mesures, poids et données techniques des produits se doivent considerer indicatifs. Notre société se réserve le droit d'apporter toutes modifications qu'elle jugerait nécessaires sans aucun préavis, sans autant diminuer la valeur de la fourniture.

Bitte betrachten Sie Masse, Gewichte und Daten der Erzeugnisse als ungefährt. Unsere Gesellschaft behält sich vor, Etwaige Abänderungen vorzunehmen, D.H. wenn diese Abänderungen nicht Beeinträchtigen.

Misure, pesi e dati tecnici dei prodotti sono indicativi. La ditta ha il diritto di fare modifiche senza avviso e senza che ciò diminuisca la qualità della macchina.

有關機器尺寸、重量及技術指標的數據均為指導性而非限定性的。公司專權在不影響機器質量的前提下不經過通知即進行改動。



Prolongació carrer Girona s/n
17455 Caldes de Malavella
Tel. 972 47 13 16 • Fax 972 47 13 75