

# P 111

PLS | P 111 | P 111 IL

## Presse per pannelli listellari

Presses for blockboard panels

Presses pour panneaux lattes

Prensas para paneles alistonados



## PLS - P 111

### Presse semiautomatiche per pannelli listellari

Semi-automatic presses for laminated boards

Presses semi-automatiques pour panneaux lattés

Prensas semi-automáticas para paneles alistonados



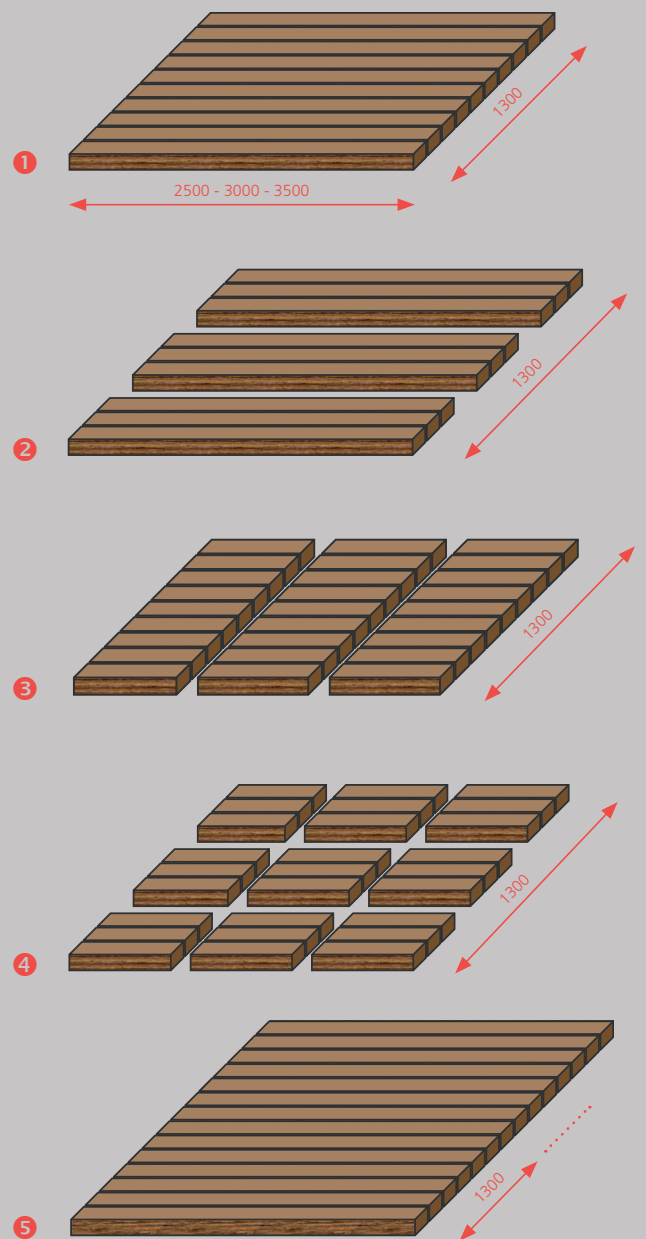

Pannello continuo oltre la larghezza del piano (P 111)  
 Continuous panel exceeding platen width (P 111)  
 Panneau continu dépassant la largeur de la table (P 111)  
 Panel continuo superior a la anchura del Plato (P 111)



P 111 con incollatrice a rullo verticale  
 P 111 with glueing-machine with vertical spreading roller  
 P 111 avec encolleuse à rouleau vertical  
 P 111 mit Anleimmaschine mit senkrechter Walze  
 P 111 con encoladora de rodillo vertical



P 111 con incollatrice a rulli orizzontali, con alimentatore a tramoggia e via a dischi immersi

P 111 with glueing machine with horizontal spreading rollers, hopper feeder and immersed-disk conveyor

P 111 avec encolleuse à rouleaux horizontaux, alimentateur à trémie et convoyeur à disques plongés

P 111 con encoladora de rodillos horizontales, tolva de alimentacion y transfer de discos inmersos

## P 111 | P 111 IL

### Ciclo di lavoro

Working cycle

Cycle de travail

Ciclo de trabajo

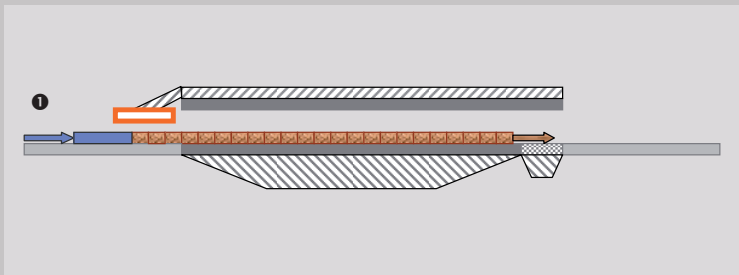

Lo spintore elettrico ① introduce il listelli in pressa

The electrical pusher ① introduces the strip set into the press

Le pousseur électrique ① introduit les listaux dans la presse

El empujador electrico ① introduce los listones en la prensa

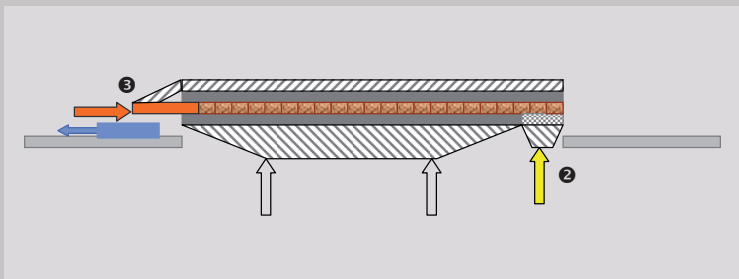

A piani chiusi senza pressione, la pinza di contrasto ② blocca i listelli ed intervengono i pressori orizzontali ③.

After platens closing without pressure, the counter-clamp ② locks the strips and the horizontal pressure ③ is given.

À tables fermées sans pression, la pince bloque ② les listaux et la pression horizontale ③ est donnée.

A platos cerrados sin presión, la pinza bloquea ② los listones y se pone la presión horizontal ③

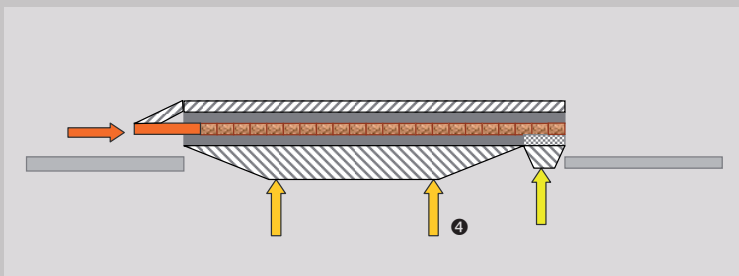

I cilindri verticali ④ danno pressione ai piani caldi della pressa, e la mantengono per il tempo necessario per la presa della colla.

The vertical cylinders ④ give pressure to the hot platens and keep it as long as necessary for the glue sticking.

Les vérins verticaux ④ donnent pressions sur les tables chauffantes et la maintiennent jusqu'à la prise de la colle.

Los cilindros verticales ④ dan presión a los platos calientes y siguen mantenerla hasta el fraguado de la cola

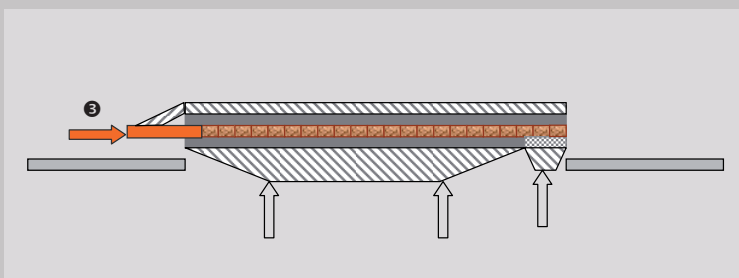

Eliminata la pressione verticale, un impulso dei cilindri orizzontali ⑤ distacca il pannello se eventualmente ha aderito ai piani.

Without vertical pressure, a pulse of the horizontal cylinders ⑤ detaches the panel from the platens in case of adherence.

Sans la pression verticale, une impulsion des vérins horizontaux ⑤ détache le panneau des platines en cas d'adhérence

Sin la presión vertical, un impulso de los cilindros horizontales ⑤ separa el panel de los platos en caso de adherencia

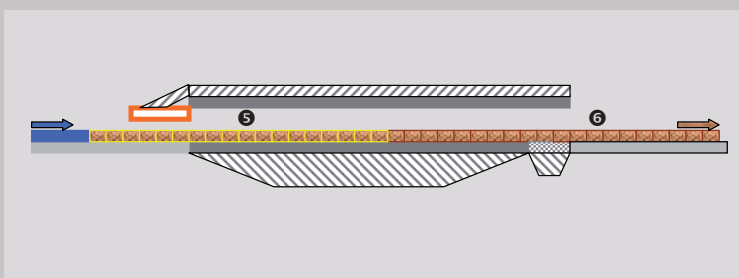

A piani aperti, il nuovo pannello ⑤ in arrivo espelle il pannello già pressato ⑥ ed inizia un nuovo ciclo di pressatura.

At platens opened, the new coming board ⑤ expels the panel already pressed ⑥ and a new pressing cycle begins.

À tables ouvertes, le nouveau panneau ⑤ qui arrive expulse le panneau déjà pressé ⑥ et un nouveau cycle commence

A platos abiertos, el nuevo panel ⑤ que llega expulsa el panel ya presado ⑥ y un nuevo ciclo de prensado comienza

## **P 111 IL**

### **Presse automatiche per pannelli listellari, con incollatrice in linea**

Automatic presses for laminated boards, with on-line glue spreader

Presses automatiques pour panneaux lattés, avec encolleuse en ligne

Prensas automaticas para paneles alistonados con encoladora en línea



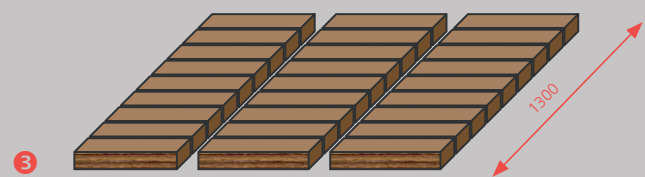
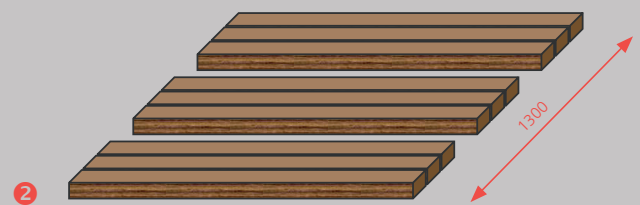
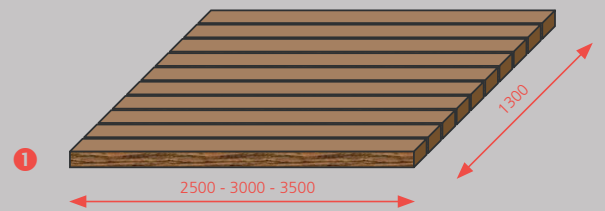
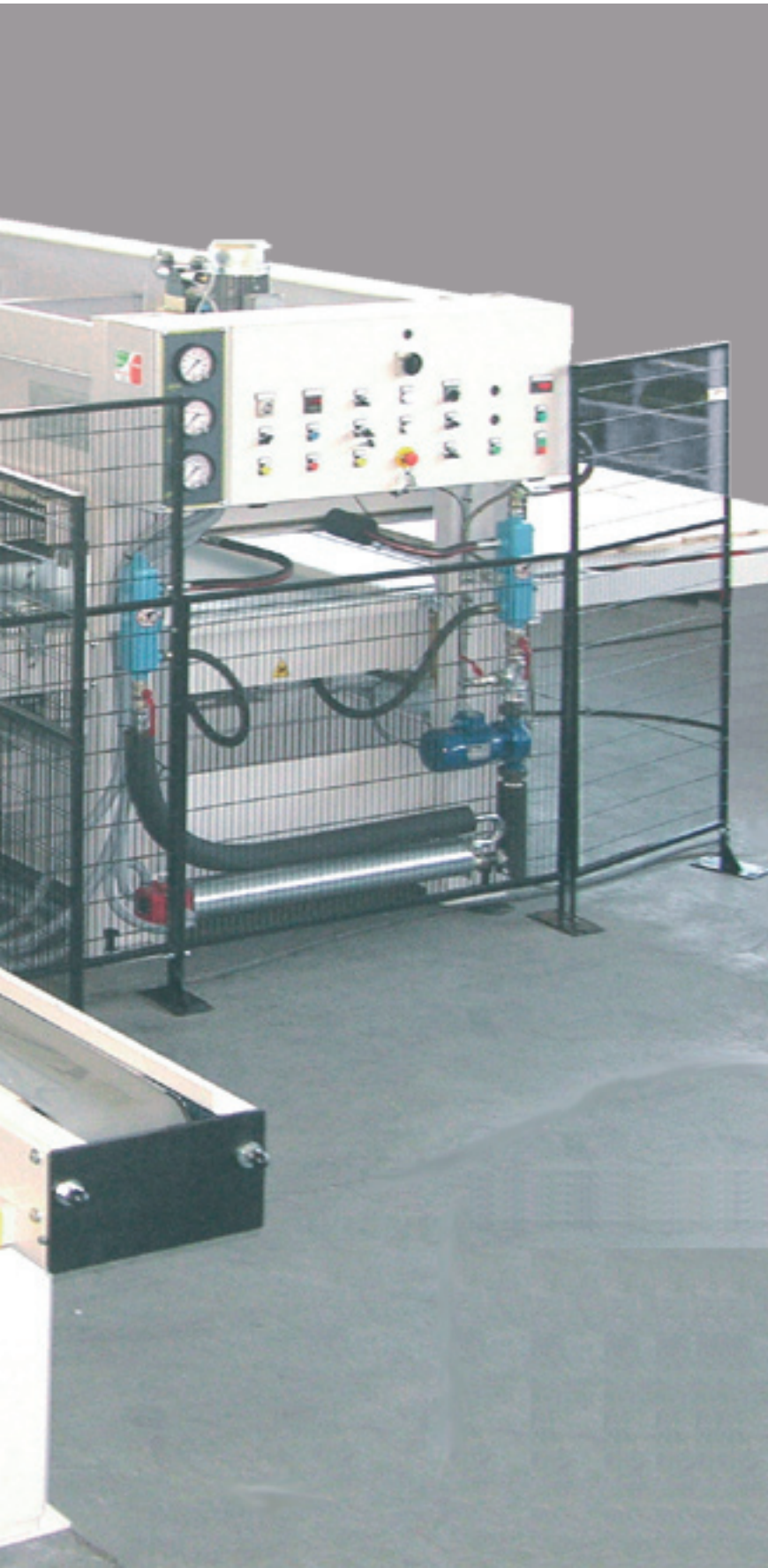

Con battute automatiche opzionali  
With optional automatic reference stops  
Avec butées automatiques en option  
Con topes automaticos opcionales

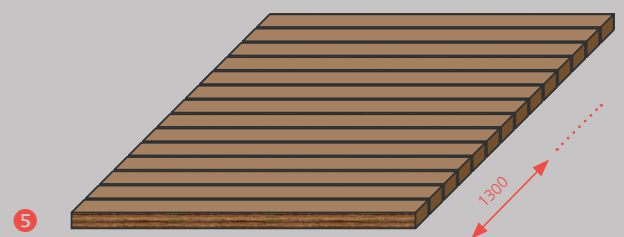
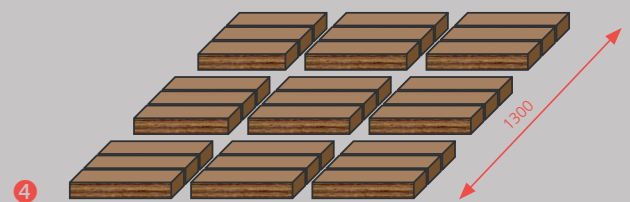

Pannello continuo oltre la larghezza del piano  
Continuous panel exceeding platen width  
Panneau continu dépassant la largeur de la table  
Panel continuo superior a la anchura del Plato

## P 111 IL

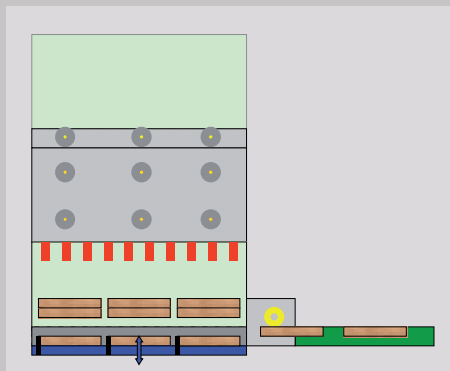

- 1 Alimentazione, incollatura e composizione 1° pannello  
Feeding, glueing, composition of the 1st panel  
Alimentation, enduisage et composition du 1er panneau  
Alimentacion, encolado y composicion del 1° panel

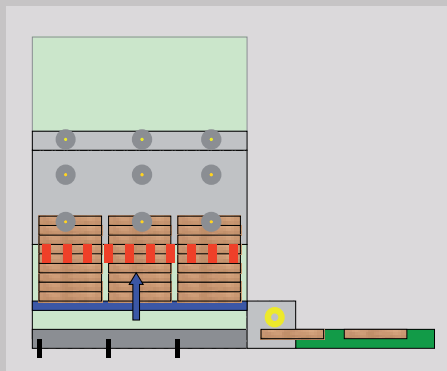

- 2 Introduzione 1° pannello in pressa  
Introduction of the 1st panel into the press  
Introduction du 1er panneau dans la presse  
Introduccion del 1° panel en la prensa

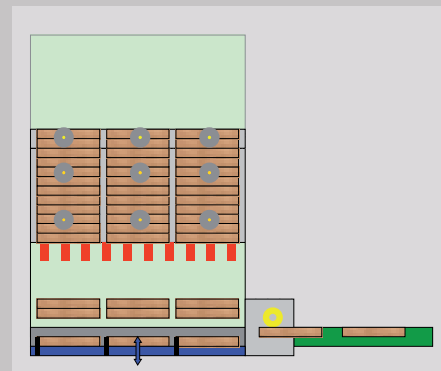

- 3 Pressatura del pannello e composizione contemporanea di quello successivo  
Pressing of the panel and simultaneous composition of the next one  
Pressage du panneau et composition en même temps du panneau suivant  
Prensado del panel y composicion en mismo tiempo del siguiente

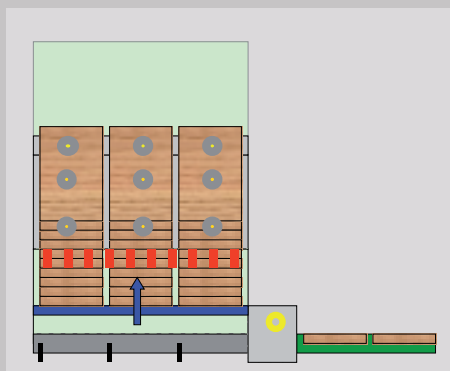

- 4 Espulsione del 1° pannello con l'introduzione del 2°  
Expulsion of the 1st panel with the introduction of the 2nd one  
Expulsion du 1er panneau avec introduction du 2ème  
Expulsion del 1 panel e introduccion del 2°

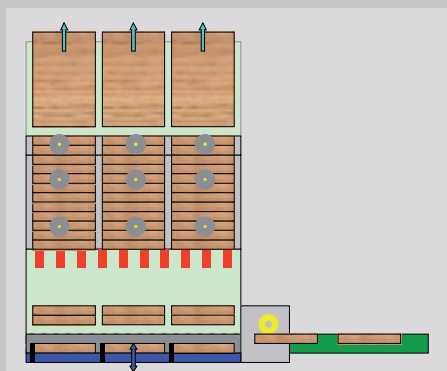

- 5 Pressatura 2° pannello, scarico del 1° e composizione di quello successivo  
Pressing the 2nd panel, unloading of the 1st and composition of the next one  
Pressage du 2ème panneau, déchargement du 1er et composition du suivant  
Prensado del 2° panel, descarga del 1° y composicion del siguiente



- 6 Produzione di pannelli continui  
Production of continuous panels  
Production de panneaux continus  
Produccion de paneles continuos



## Presse per pannelli listellari

Presses for laminated panels

Presses pour panneaux lattés

Prensas para paneles alistonados



PLS, P 111, P 111 IL

Piastre e cilindri di pressione orizzontale  
Plates and cylinders for horizontal pressure  
Plaques et vérins de pression horizontale  
Placas y cilindros de presión horizontal



P 111 IL

Versioni CE con recinzione metallica  
CE versions with metal safety fencing  
Versions CE avec enceinte métallique  
Versiones CE con recinto metalico



P 111 IL

Particolari del tappeto di carico, dell'incollatrice a rullo verticale, delle battute di posizionamento automatiche (opzionali) e dello spintore.

Details on the feeding belt, the glue spreader with vertical roller, the automatic positioning stops and the pusher.

Détails du tapis de chargement, de l'encolleuse à rouleau vertical, des butées automatiques de positionnement (en option) et du pousseur

Detalles del tapete de carga, de la encoladora de rodillo vertical, de los topes automaticos de posicionamiento (opcionales) y del empujador



P 111, P 111 IL

Lato di uscita e pinza di contrasto con cilindri indipendenti

Unloading side and counter-clamp with independent cylinders

Côté de sortie et pince de contre-butée avec vérins Indépendants

Lado de salida y pinza de contra-tope con cilindros independientes



• **CARATTERISTICHE TECNICHE • TECHNICAL DATA**  
 • **DONNEES TECHNIQUES • DATOS TECNICOS**

	U.M	PLS	P 111 P 111 IL
• Lunghezze utili • Working lengths • Longueur utile • Largo util	mm	a: 2500 b: 3000 c: 3500	a: 2500 b: 3000 c: 3500
• Larghezza utile • Working width • Largeur utile • Ancho util	mm	1300	1300
• Apertura • Daylight • Ouverture • Apertura	mm	150	150
• Spinta orizzontale • Horizontal thrust • Pression horizontale • Presion horizontal	kg	a:12.500 b: 15.000 c: 17.500	a:12.500 b: 15.000 c: 17.500
• Pressione specifica orizzontale (su pannelli di spessore 40 mm) • Horizontal specific pressure (on 40 mm thick panels) • Pression spécifique horizontale (sur panneaux épaisseur 40 mm) • Presion especifica horizontal (sobre paneles espesor 40mm)	kg/cm2	12,5	12,5
• Cilindri orizzontali • Horizontal cylinders • Cylindres horizontaux • Cilindros horizontales • Numero • Number • Nombre • Numero • Diametro • Diameter • Diamètre • Durchmesser • Diametro • Corsa • Stroke • Course • Lauf • Recorrido	N. mm mm	a: 5 b: 6 c: 7 Ø 50 150	a: 5 b: 6 c: 7 Ø 50 150
• Spinta verticale • Vertical thrust • Pression verticale • Presion vertical	kg	a: b: c:	
• Cilindri verticali • Vertical cylinders • Cylindres verticaux • Cilindros verticales • Numero • Number • Nombre • Numero • Diametro • Diameter • Diamètre • Durchmesser • Diametro • Corsa • Stroke • Course • Lauf • Recorrido	N. mm mm	a: 4 b: 6 c: 6 a: Ø 70 b: Ø 70 c: Ø 70 200	a: 4 b: 6 c: 6 a: Ø 70 b: Ø 70 c: Ø 70 200
• Cilindri pinza • Clamp cylinders • Cylindres du presseur • Cilindros del prensor • Numero • Number • Nombre • Numero • Diametro • Diameter • Diamètre • Durchmesser • Diametro	N. mm	3 a: Ø 70 b: Ø 70 c: Ø 70	3 a: Ø 70 b: Ø 70 c: Ø 70
• Centralina pressione verticale • Vertical pressure pump • Pompe de pression verticale • Pompe de pression verticale	kW	2,2	2,2
• Centralina pressione orizzontale • Horizontal pressure pump • Pompe de pression verticale • Bomba de presion horizontal	kW	1,5	1,5
• Centralina pinza • Clamp pump • Pompe du presseur • Bomba del prensor	kW	-	1,5
• Boiler elettrico • Electric boiler • Chaudière électrique • Caldera electrica	kW	18	18
• Peso • Weight • Poids • Gewicht • Peso (a-b-c)	kg x 100	-	48-58-68

L= 2500 mm, 3000 mm, 3500 mm

mm	PLS	P111	P111 IL
A	L +1500	L +1500	L +3250
B	4925	4925	4925

(Ingombri al netto della recinzione CE  
 Overall sizes without CE safety fencing  
 Encombremens sans enceinte CE  
 Medidas sin recinto metalico CE)

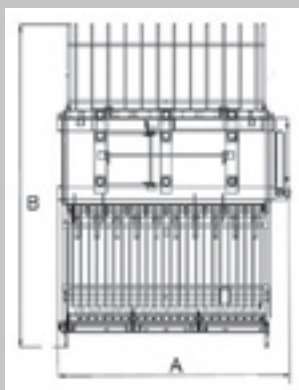

PLS - P111

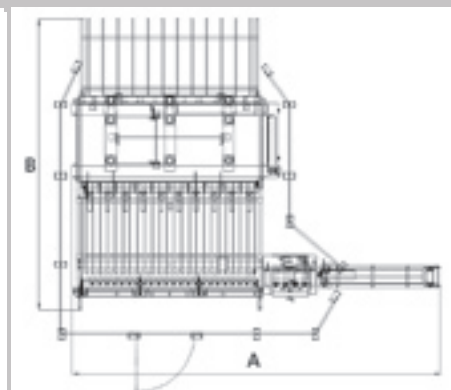

P111 IL

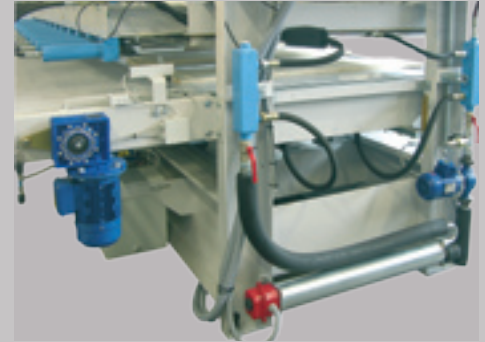
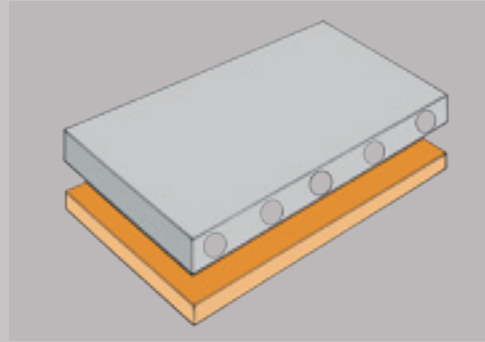
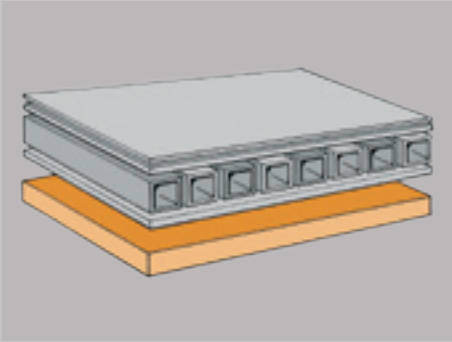

Piani standard a serpentine  
(copertura inox opzionale)  
Standard tables with square pipes  
(optional: stainless steel cover)  
Tables standard à serpentins  
(revêtement inox en option)  
Platos standard con serpentinos  
(revestimiento inox en opcion)

**Optional**

Piani massicci forati per alte pressioni  
Drilled massive tables for high pressures  
Tables perforées en acier massif  
pour hautes pressions  
Platos macizos agujerados para  
presiones elevadas  
Copertura in Mylar a richiesta - covered with  
Mylar on request - revêtement Mylar sur demande  
Cobertura en Mylar bajo pedido

Riscaldamento ad olio diatermico  
con boiler elettrico (standard)  
Oil heating with electric boiler (standard)  
Chauffage par huile thermique  
avec chaudière électrique (standard)  
Calentamiento por aceite termico  
con caldera electrica (standard)



I tempi di ciclo, essendo le linee di colla verticali, dipendono sostanzialmente dallo spessore dei listelli. Il sistema riscaldamento con generatore ad alta frequenza (opzionale), riduce drasticamente i tempi di presa della colla ed è quindi indicato per incrementare la produzione, particolarmente nel caso di spessori consistenti.

The cycle times, since the lines of glue are vertical, depend on the strip thickness. The heating system by high-frequency generator (optional) reduces very much the glue sticking times, so it is advised to increase the production, specially in case of relevant thicknesses.

Les temps du cycle, étant les lignes de colle verticales, dépendent substantiellement de l'épaisseur des listaux. Le système de chauffage avec générateur de haute fréquence (en option) réduit drastiquement les temps de prise de la colle et donc est indiqué pour augmenter la production, surtout en cas d'épaisseurs élevés.

Los tiempos del ciclo, siendo las líneas de cola en vertical, dependen substancialmente del espesor de los listones. El sistema de calentamiento con generador de alta frecuencia (opcional) reduce mucho los tiempos de fraguado de la cola y por lo tanto es indicado para aumentar la producción, especialmente en caso de espesores elevados

**Optional:** Pressori orizzontali supplementari; pressori orizzontali sul lato da 1300 mm; regolazione manuale in altezza dei cilindri orizzontali; battute pneumatiche per il sistema di carico (P 111 IL)

Additional horizontal cylinders; horizontal cylinders on the 1300 mm side; manual adjustment of the height of the horizontal cylinders; pneumatic positioning stops for the loading system (P 111 IL)

Presseurs horizontaux supplémentaires, presseurs horizontaux sur le côté 1300mm, réglage manuel en hauteur des vérins horizontaux, butées pneumatiques pour le système de chargement (P 111 IL)

Prensos horizontales suplementarios, prensos horizontales en el lado 1300mm, reglado manual en altura de los cilindros horizontales, topes neumaticos para el sistema de carga (P 111 IL)



**STETON s.p.a.**

S.S. Romana Nord, 41/a

41012 Carpi (MO) ITALY

Tel. +39 059 686771

Fax +39 059 681774

steton@steton.it

www.steton.it



**Oltre alla serie PLS – P 111 – P 111 IL ,**

è disponibile anche la serie P 110, con prestazioni ancor più elevate. Per la produzione di pannelli listellari, la Steton fornisce anche linee complete, dalla produzione dei listelli alla sezionatura e calibratura-levigatura dei pannelli.

**Besides the PLS – P 111 – P 111 IL ,**

the even more performing series P 110 is also available. For the production of laminated boards, Steton supplies complete lines too, from the production of the strips up to the cutting to size and the final finishing of the panels.

**Outre à la série PLS – P 111 – P 111 IL,**

est aussi disponible la série P 110, avec prestations plus élevées. Pour la production de panneaux lattés, la Steton offre aussi lignes complètes, de la production des listaux au sciage et calibrage-ponçage des panneaux.

**Además de la serie PLS - P 111 – P 111 IL,**

también está disponible la serie P 110 con rendimiento mas elevado. Para la produccion de paneles alistonados, la Steton ofrece tambien lineas completas, desde la produccion de listones al seccionado, calibrado y lijado de los paneles