

4D - high-end  
sawing centre

CONTROL

EVOLUTION

STANDARD

COMPACT

STRIEBIG

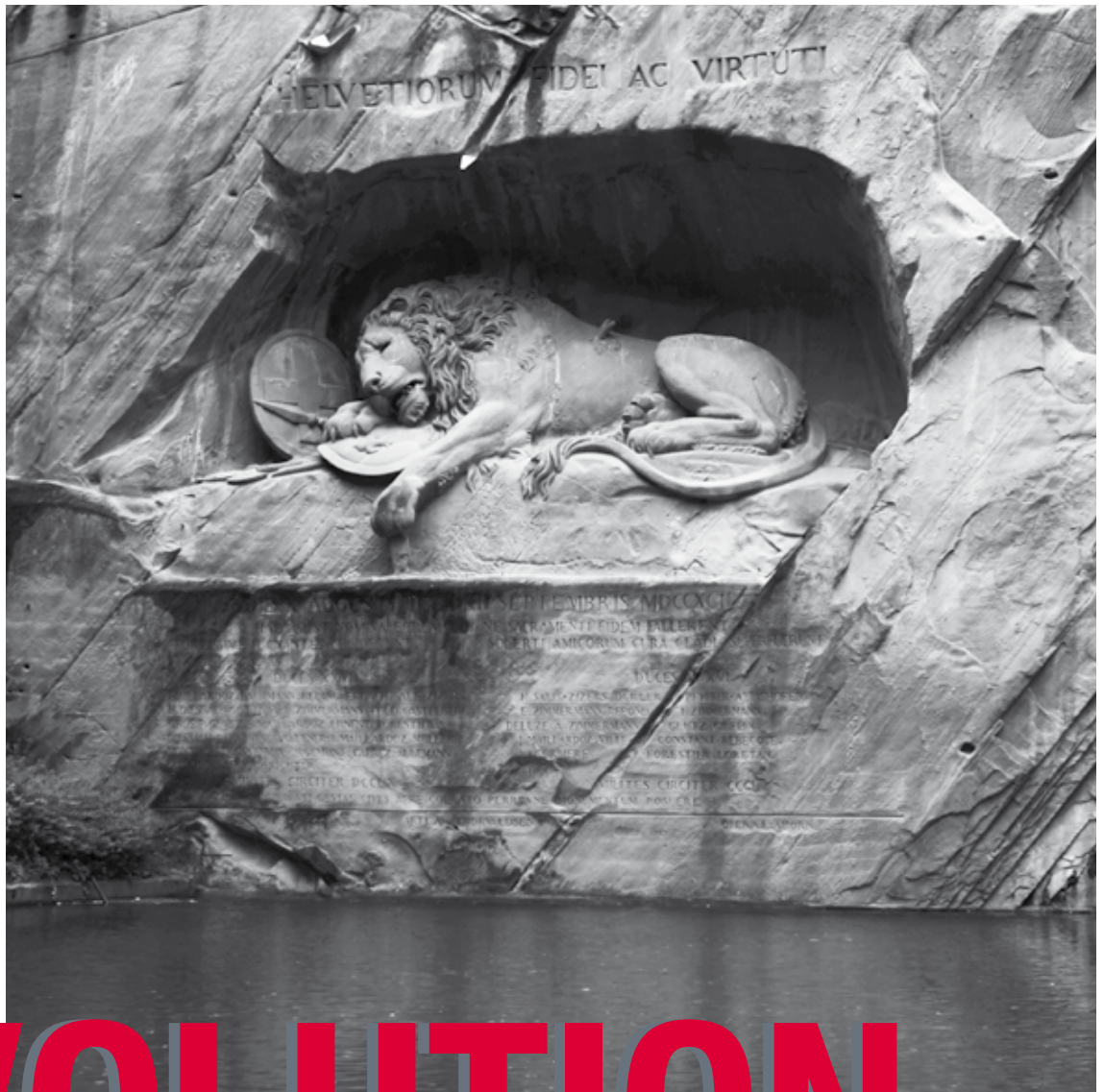

# EVOLUTION

Superior class  
in vertical sawing technology

incl.  
tool database

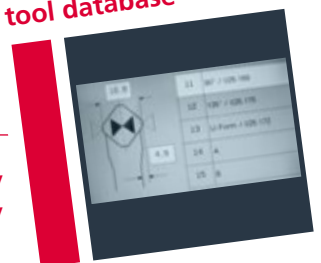

**Standard:** high degree of flexibility  
and excellent repeat accuracy

# Experience and innovation

## ■ The name for vertical cutting technology

For us, vertical sawing technology is both a passion and a mission. As the only manufacturer of vertical panel saws in the world we exclusively specialise in this individual product category: vertical panel saws. We create sustainable values - with all our experience, with a high degree of compassion in our development team and extensive knowledge of the your daily requirements: STRIEBIG, the synonym for vertical panel saws.

Our leading market position for decades is owed to your trust, consists "Swiss Made" with high product quality and the reliability of our tried-and-tested specialist trading partners.



Built corporate identity: the facade of the corporate headquarters in Littau near Lucerne features vertical aluminium pilaster strips that form an excellent point of reference with our products and market partners.

## ■ Standard: high degree of flexibility and excellent repeat accuracy

Your data for sawing, profile cutter and grooving tools can be stored in the integrated tool database.

An invaluable benefit where tools are frequently changed.

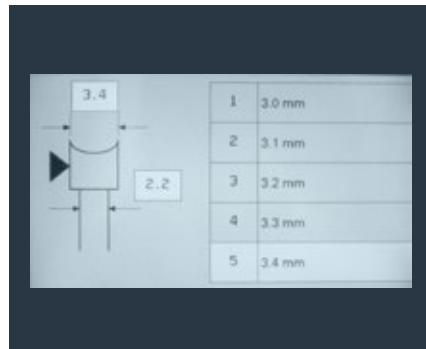

## ■ The saw frame - always solid and precise

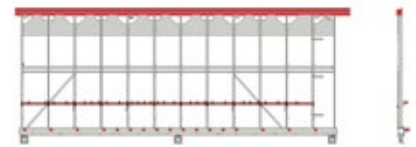

- Precision machine parts manufactured to an accuracy of 1/100 mm
- Massive, self-supporting, firmly welded, twist-free saw frame
- Full-surface support wall of birch plywood with integral small workpiece support
- Auxiliary stop profile with measuring tape and 3 auxiliary stops for repeat cuts
- Automatic section of the central support
- Automatic roller locking during the saw cuts

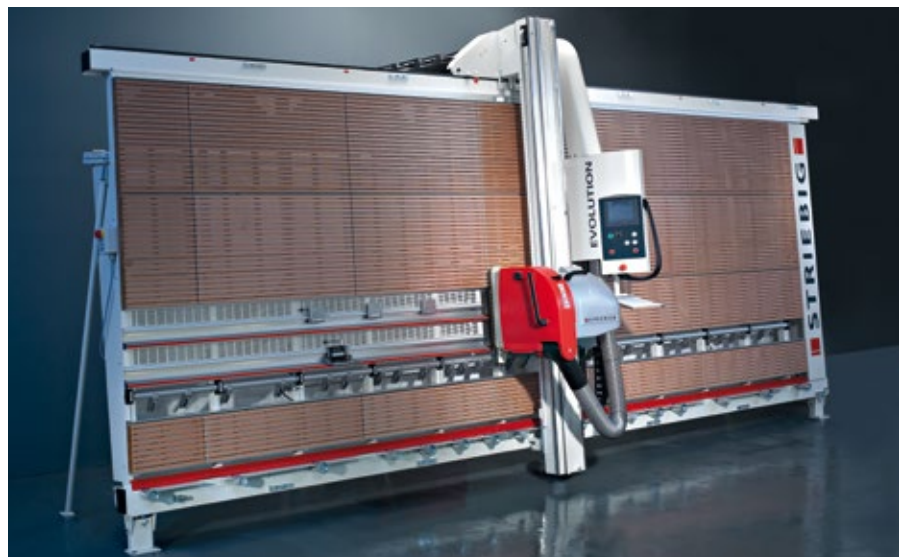

Striebig EVOLUTION 6224 (fig. includes optional features)

"HELVETIORUM FIDEI AC VIRTUTI" – To the Loyalty and Bravery of the Swiss – is the beginning of the inscription of the Lion Monument in Lucerne. The monument was designed by the Danish sculptor Bertel Thorvaldsen, and in 1821 it was carved out of the wall of a former sandstone quarry. With the allegory of the dying lion, the monument commemorates the Swiss Guards who were massacred during the attack on the Tuileries Palace in 1792. The American writer Mark Twain praised the Lion of Lucerne as "the most mournful and moving piece of stone in the world."



EVOLUTION

■ **Touch and work**

"Touch & saw" – this revolutionary concept permits safe and trouble-free saw operation. A finger tip suffices to operate the EVOLUTION. The touchscreen's 7,5" colour display visualises all functions.



The user interface and error recognition are multilingual. Self-explanatory symbols lead the user through the menu. Only the functions that the saw is capable of are ever displayed. This largely rules out incorrect operation. The operating time counter integrated as standard captures the time at the saw.

Externally created cutting lists can be imported simply and easily via a USB port.

■ **TRK dust extraction system – clean air at all times**

Take a deep breath. Thanks to the integral TRK dust extraction system we achieve dust limit values considerably below 1mg/m<sup>3</sup>. We are therefore more than 50 % below the applicable recommended values.

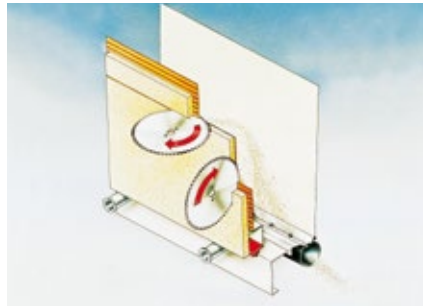

■ **Saw beam & saw unit – always the correct cut**



Automatic motor swivelling is only one of the countless functions of the EVOLUTION in support of manual sawing.

■ **Saw beam & saw unit**

- Stable, durable saw beam design
- Smooth-running guides free of play
- Automated operation for enhanced user-friendliness
- Robust bearing of the motor carriage ensures high cutting precision
- Cutting depth 80 mm (Option: 100 mm)
- Powerful, high-torque 5.5 kW motor (7.5 hp)
- Electromagnetic motor brake



Laser-assisted indication of the horizontal cut (standard)

■ **DMS – always the right dimension**



Digital measuring system DMS on both axes (standard). Freely selectable display accuracy from 1.0/0.5 to 0.1 mm.

# Precision, ergonomics and functionality in perfect harmony

## ■ EVOLUTION – superior class over again

The EVOLUTION has gained a leading position in the hand-guided vertical panel saw sector for almost a decade. Numerous automatic functions facilitate daily work. A touchscreen control panel with an innovative PLC control safely guides you through the diversity of functions.

## ■ EVOLUTION – always fully equipped from the start

See for yourself – the EVOLUTION is supplied with a range of equipment rarely encountered on any other vertical saw.

- Digital measuring system DMS (both axes)
- Automatic saw beam locking with cutting point recognition
- Laser-assisted indication of the horizontal cut
- Automatic locking and swivelling of the saw unit
- Automatic plunge and withdrawal movement of the saw unit
- Automatic fine calibration of the sawmotor
- Operating time counter
- Tool database
- Exceptionally efficient integral TRK dust extraction system. Dust limit value well below  $1\text{mg}/\text{m}^3$ .
- Aluminium central support over the entire length of the machine
- Super silent sound insulation

## ■ EVOLUTION – Always the perfect choice

Due to its appearance, the EVOLUTION represents high perceived value. The award-winning product design (e.g. design preis schweiz, among others), sets itself apart from the usual monotony of woodworking machines. Its ergonomics are tailored to function and operator.

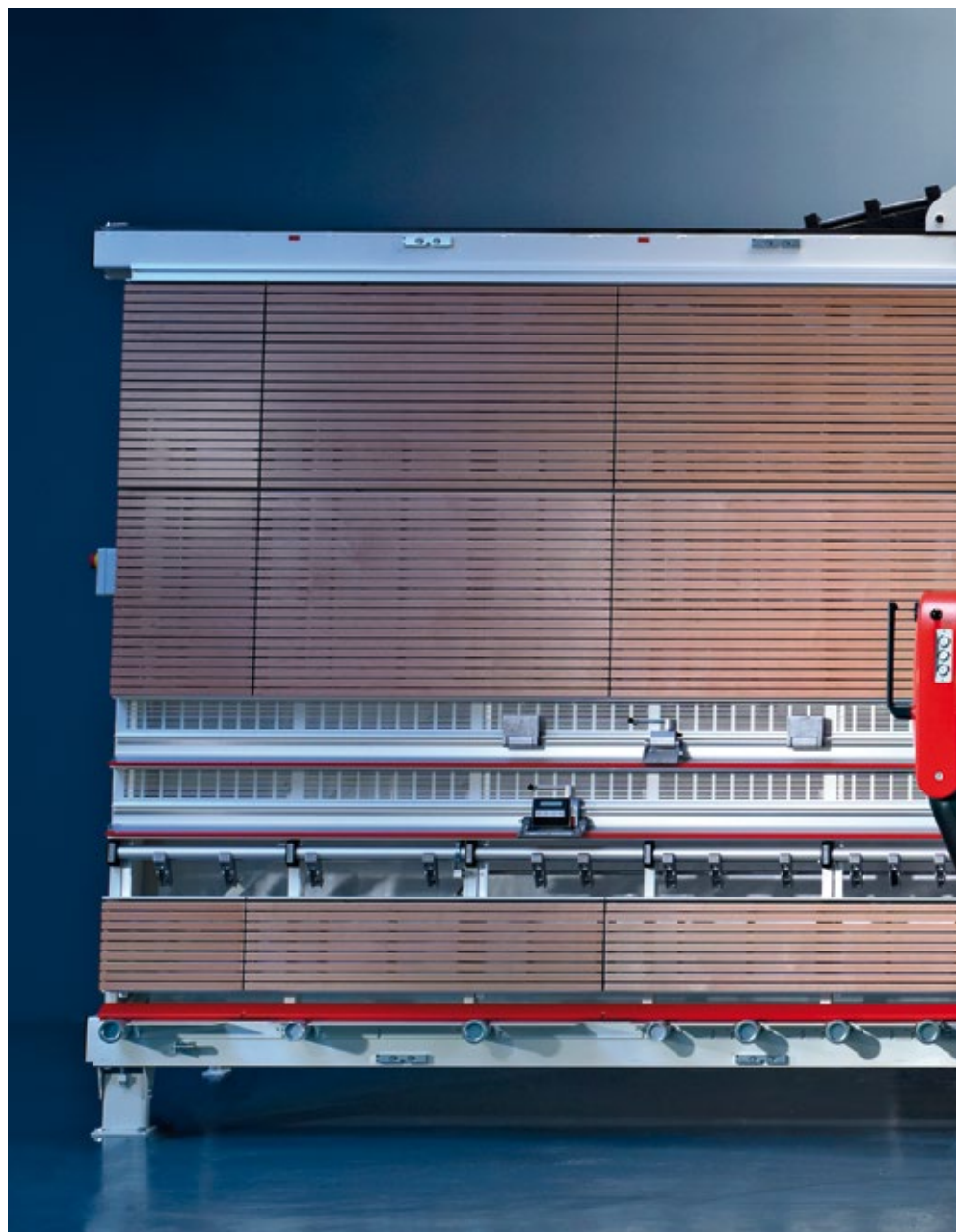

Striebig EVOLUTION 6224 (fig. includes optional features)



**EVOLUTION**

EVOLUTION – Superior class vertical panel cutting technology. See for yourself in this video.



# Added value - Accessories for your EVOLUTION, quite individual

Every EVOLUTION comes comprehensively equipped ex works. Thanks to the wide range of accessories available, the machine is fully adjustable to meet your individual needs. Upon request special dimensions can be accommodated. Contact us to discuss your requirements.

## ■ The range of EVOLUTION accessories

- 4SB – Automatic bottom trimming
- EPS.x – Electronic positioning system for the x-axis
- VSA – Scoring saw unit
- WSG – Angle cutting unit
- NVV – Grooving accessory for composite panels and adjustable grooving tool
- "High-end" central support
- Paper holder
- Cutting depth 100 mm
- Saw motor with 2 speeds
- Special voltage
- Tropical insulation

## ■ 4SB – the lower trimming cut becomes child's play



The 4SB option, an accessory for the lower trimming cut, makes work considerably easier. Panels are securely held by vacuum cups, relieving the operator of any physically exhausting work. The lower edges of panels up to 5300 mm long and up to 2185 mm tall are automatically trimmed.

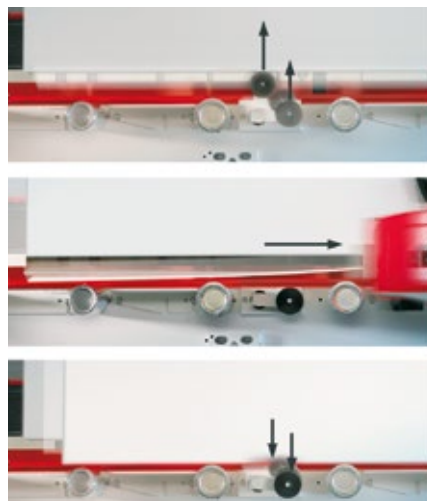

## ■ VSA – even greater cutting quality for coated panels



Time-, cost- and tool-saving – these are the benefits offered by a scoring saw unit VSA. If larger panel quantities or panels of possibly lower quality are to be processed, the use of a VSA is a "must". Because it extends the service life of a main saw blade 7–8 fold. A scoring saw blade lasts at least as long as 3 main saw blades.

## ■ EPS.x – enter and done



Enter the dimensions – that's it. The electronic positioning system EPS is fully integrated into the touchscreen panel. It allows the simple positioning of the horizontal x-axis with 1/10 mm precision.

■ Grooving and routing – expand your range of services



Many jobs require grooving or routing work. The EVOLUTION can perform such tasks without any problems. You can route or groove timber products and composite panels.

With regard to adjustable grooving tools and composite panel cutters, the EVOLUTION only requires one depth stop. Any risk of confusion is thus eliminated.

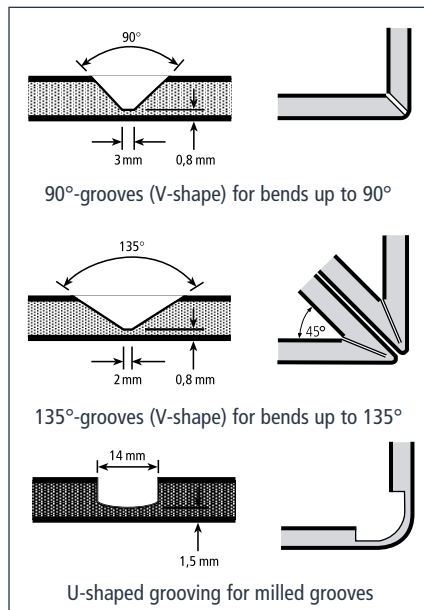

■ WSG – cutting mitres with precision



The angle cutting unit WSG can be applied to the left and right of each vertical cutting point. It is quick and easy to fit. Range of application: panels with thicknesses of up to 42 mm, precise angles and mitres from 0° to 46°.

■ Central support made from fibre-reinforced plastics



“High-end” frames made from fibre-reinforced plastics provide special protection for particularly sensitive edge materials and postforming edges.

■ SSD – saw motor

Particularly recommended if different materials are frequently processed: SSD – the saw motor with infinitely variable speed.

■ Paper holder – documents are always at hand



Securely held – the paper holder keeps documents at hand, next to the touchscreen panel.



The depth stop is infinitely adjustable using a scalable handwheel (up to 25 mm).



STRIEBIG 4D



CONTROL



EVOLUTION



STANDARD



COMPACT

# Impressive: EVOLUTION data and dimensions

It occupies a market-leading position in the hand-guided vertical panel saw sector: the EVOLUTION – our superior class in vertical sawing technology. The EVOLUTION combines innovative „touch & saw“ control with ease of operation, precision to 1/10 mm and a comprehensive range of accessories.

EVOLUTION							
Type	Dimensions in mm				Cutting range in mm		
	L	H	D1*	D2*	L	Hvert	Hhor
6224	7,161	3,018	1,741	1,361	5,300	2,240	2,100
6216	7,161	2,934	1,700	1,354	5,300	2,160	2,016
6168	7,161	2,460	1,500	1,312	5,300	1,680	1,540
5224	6,161	3,018	1,741	1,361	4,300	2,240	2,100
5216	6,161	2,934	1,700	1,354	4,300	2,160	2,016
5168	6,161	2,460	1,500	1,312	4,300	1,680	1,540
4224	5,161	3,018	1,741	1,361	3,300	2,240	2,100
4216	5,161	2,934	1,700	1,354	3,300	2,160	2,016
4168	5,161	2,460	1,500	1,312	3,300	1,680	1,540
EVOLUTION							
Weight of the saw	approx. 1,200 kg		Saw blade speed		4,800 rpm		
Cutting depth	80 mm*2		1 extraction connector		Ø 140 mm		
Saw motor rating	5.5 kW		Compressed air connection		6-10 bar		
Saw blade diameter	300 mm		Wattage		7.5 kW		
Saw blade bore	30 mm*1		Mains connection		3 x 400 V / 50 Hz		
Emission sound pressure level at the workplace L <sub>pA</sub>			83 dB*3				
Special voltages and special frequencies on request							

D1\* for free-standing installation · D2\* for wall-mounted assembly · \*1 with 2 side holes Ø 9 mm, radius 30 mm  
\*2 option: 100 mm · \*3 Measurement standards and emission values in accordance with EN 1870-14, measurement uncertainty allowance K = 4 dB(A)  
(All details refer to the EVOLUTION type 6224)

Consultation · Sales · Service



The SWISS LABEL emphasises the origin and quality awareness of goods and services of Swiss origin. STRIEBIG AG is entitled to the use of this trademark.

Please refer to our website for the most current technical specifications of the EVOLUTION. Scan the QR code. Done!



EVOLUTION – superior class vertical sawing technology

Exceptionally efficient integral TRK dust extraction system\*\*. Dust limit value well below 1 mg/m<sup>3</sup>.

\*\*TRK is the abbreviation for „Technische Richt-Konzentration“ (technical target concentration). These values have been applicable since July 1988 and specify the maximum permissible wood dust concentration at the workplace. The TRK value is 2 mg/m<sup>3</sup> total dust based on a working average (shift) of 8 hours. Connection to an external dust extraction system is required. The system used must have an extraction performance of 20 m<sup>3</sup>/sec. (vacuum approx. 1,400 Pa.) at the connector in order to meet the TRK specifications.

**Striebig AG**  
Grossmatte 26  
CH-6014 Luzern  
Tel. 0041(0)41 259 53 53  
Fax 0041(0)41 259 53 50  
www.striebig.com  
info@striebig.ch

