

# Wadkin

## 7" FB 180

British Standard Classification 12.34

### PLANER AND MOULDER

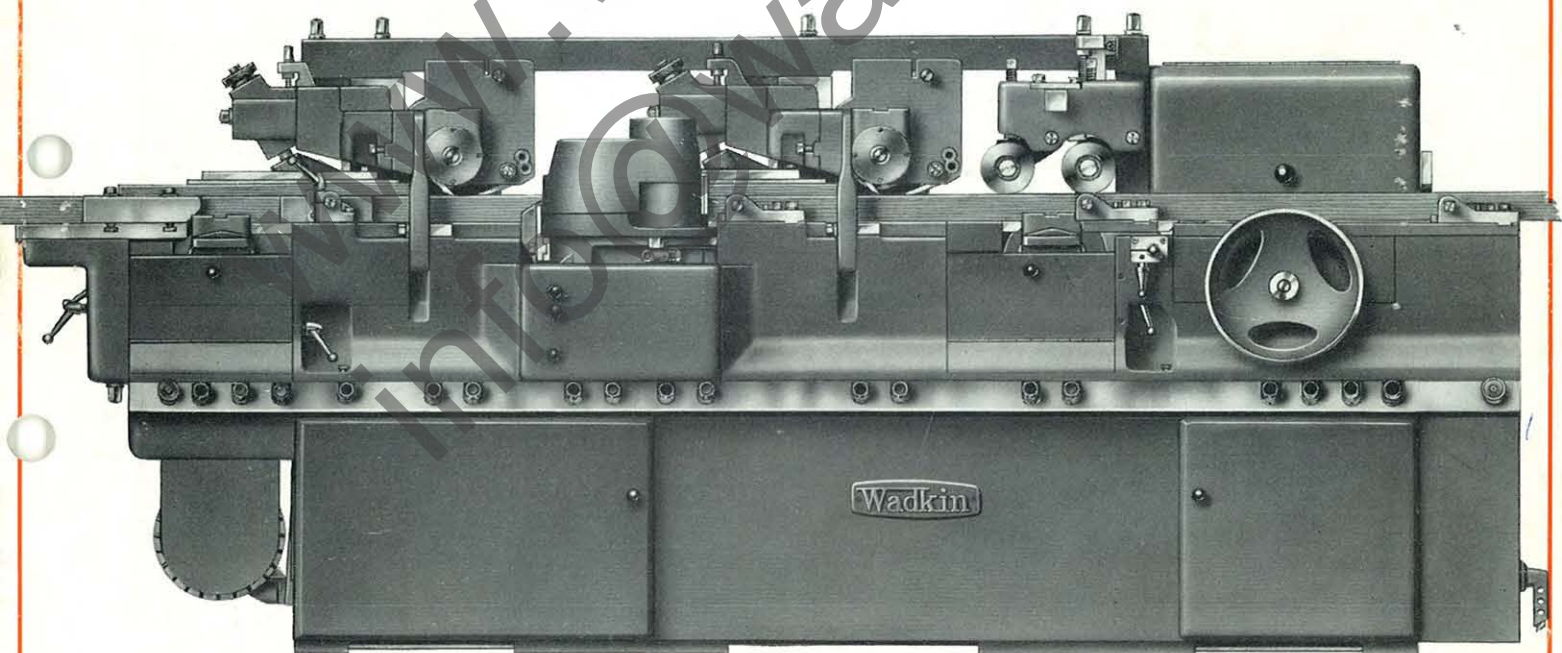

An entirely new design of compact, medium-duty moulder for work up to 7" x 4" capacity. The notably clean and modern appearance is matched by a simplicity of controls and adjustments, making the machine very suitable for quick setting-up of detailed mouldings which, together with its economical price, will bring four-side machining within the scope of the smaller user, and supplement larger installations for shorter run work. The machine is also ideally suited to technical establishments as all syllabus requirements can be taught and demonstrated. All cutterblocks are readily removable cone mounted. The spindles run at 6,000 r.p.m. and are driven by vee belts. A quick belt change arrangement on cone pulleys gives a lower speed of 4,200 r.p.m., carefully selected for ideal jointing performance. This and the provision of outboard bearings enables jointing work to be undertaken for long runs at 100 ft/min (120 ft/min to order).

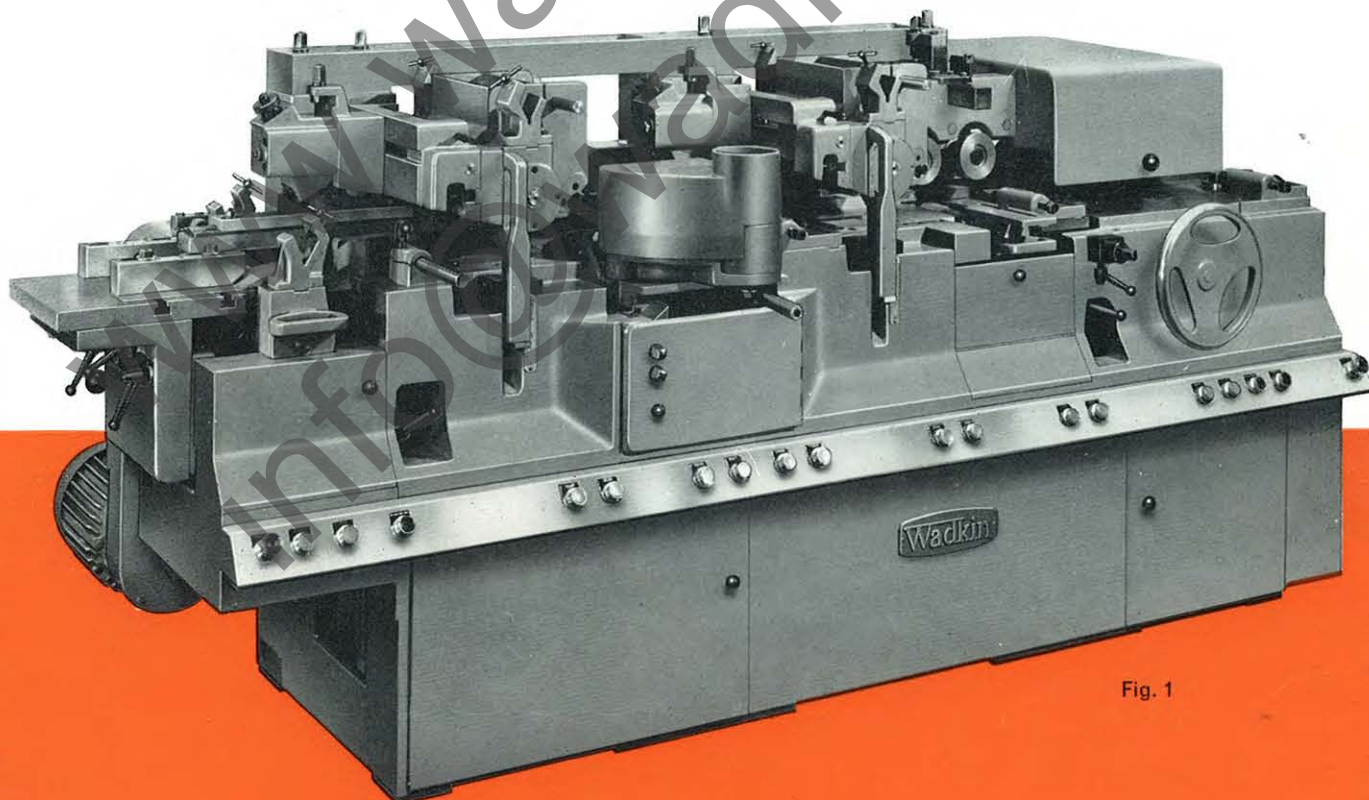
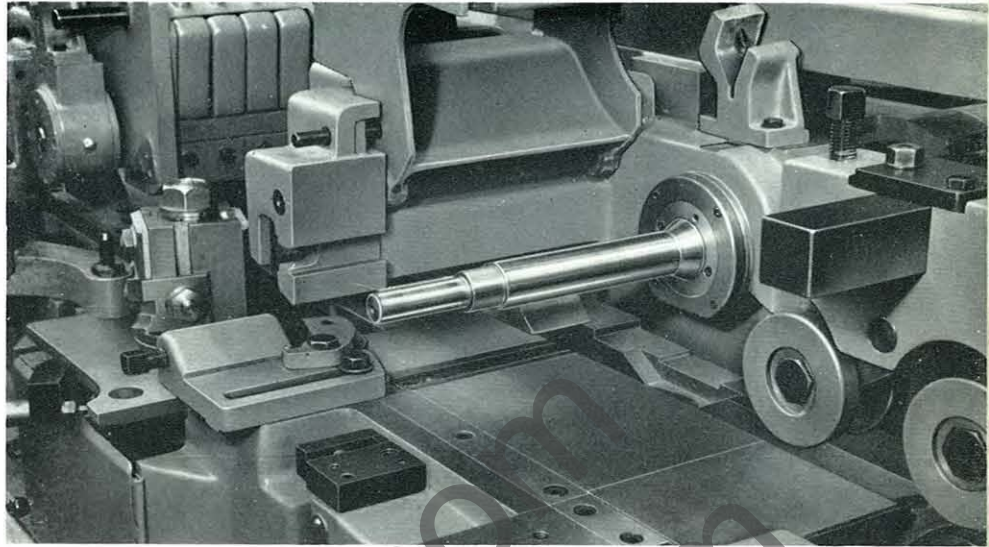

Fig. 1

# Wadkin

All spindles are readily accessible. Outboard bearings fitted to horizontal spindles are readily removable.

Fig. 4



It is the work of a few moments only to remove the outboard bearing, slide off the cone-mounted, self-centring block and replace with another previously set up and balanced.

Fig. 5

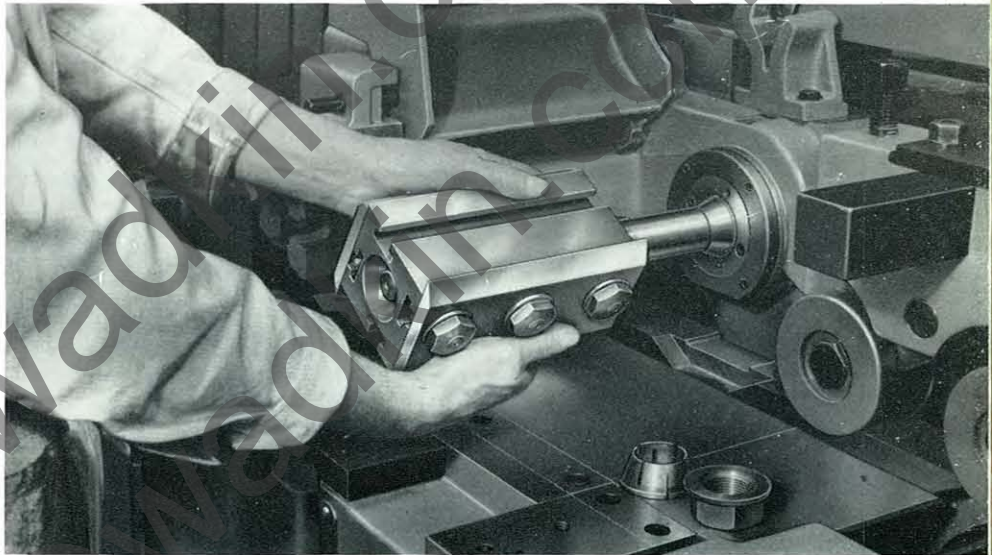

Using pre-set blocks ensures the maximum running time from the machine and makes short runs of varied work more economical and profitable.

Fig. 6

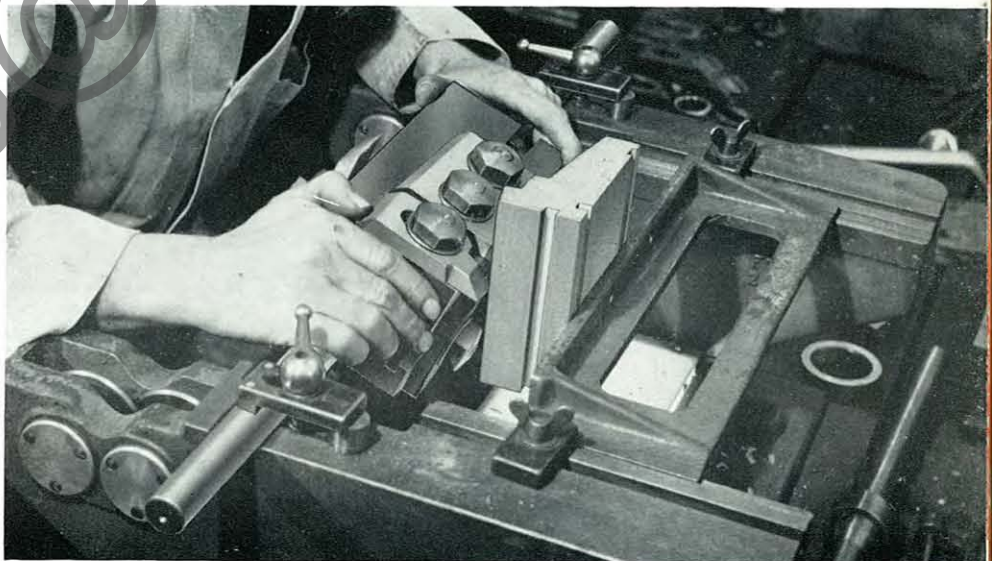

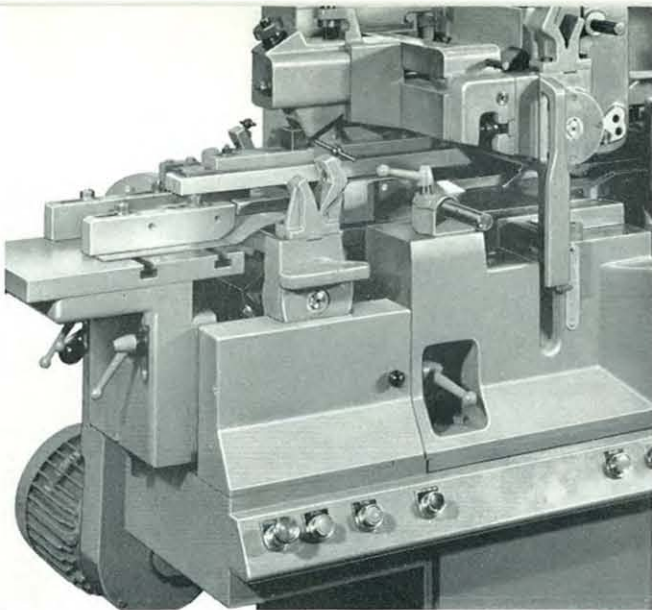

Fig. 7

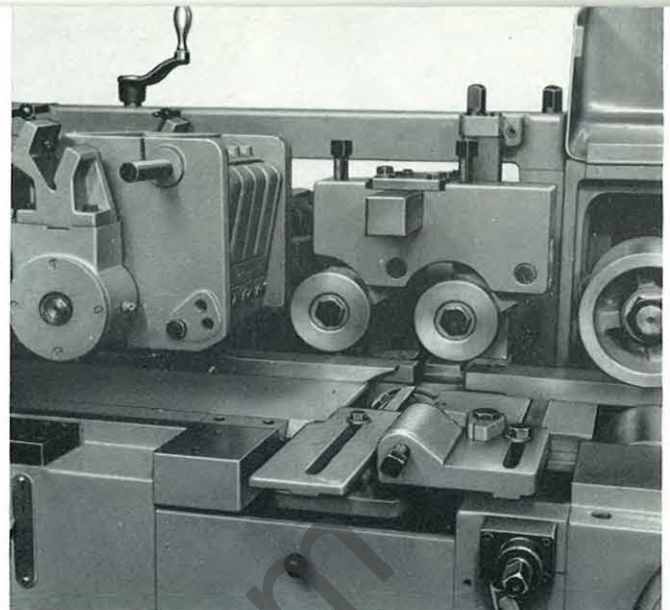

Fig. 10

**Second top and second bottom heads (Fig. 7)**

The table after the second bottom head withdraws to accommodate varying cutting circles and give access to the block. Table under the second top head has "Permalin" or compressed wood insert to allow cutters to project through the job when split.

Master stop button is provided at this end of the machine to stop all motors throughout the machine, in addition to buttons controlling the adjacent heads.

**Side heads (Fig. 8)**

The fence side head cuts slightly in advance of the near side. Both heads have vertical and horizontal adjustment. Near side chipbreaker is radial and spring loaded and incorporates adjustments for moulding iron projection and variations in cutting circles. It has quick release feature enabling it to be swung clear of the block for setting up or jointing. Both chipbreaker and hood have been carefully developed to ensure maximum efficiency in chip collection.

**First bottom and first top heads (Fig. 10)**

All spindles have vertical and horizontal adjustment, all of which are easily accessible and can be made whilst the heads are running. Spring loaded adjustable roller pressures are mounted over bottom block, chipbreakers for top heads are radial weight loaded and integral with dust hoods. Feed pressures following top block (Fig. 8) adjust with the head and have fine adjustment in a vertical movement by screw.

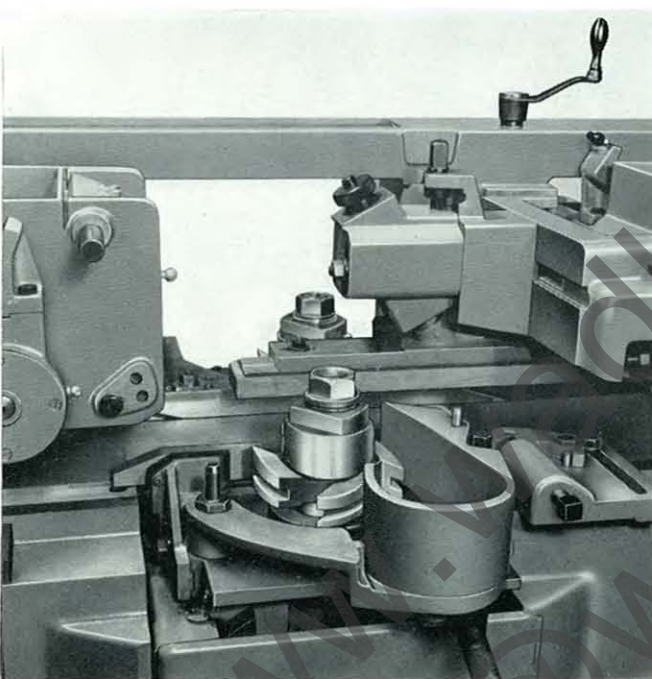
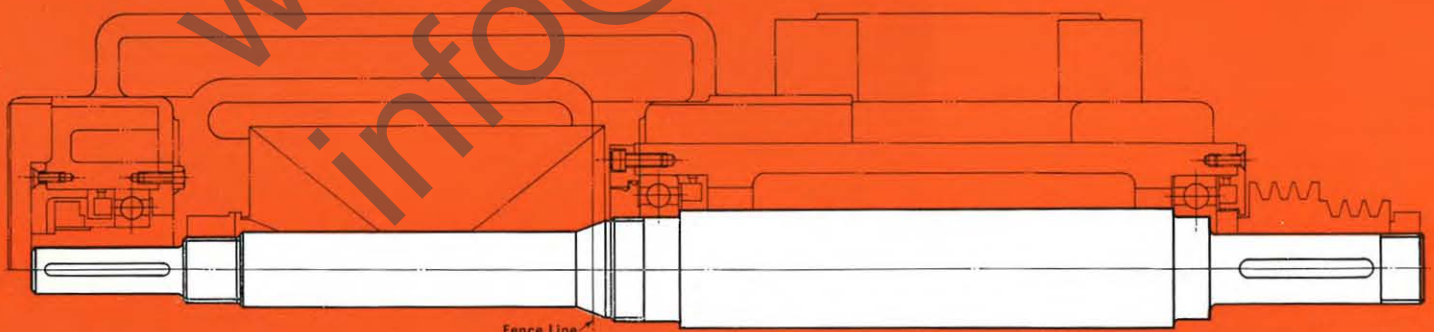

Fig. 8



**Cross section of spindle with 40 mm. spindle end**

Fig. 9 All spindles and housings are of robust design to ensure vibrationless running. Spindle is mounted in deep groove ball bearings. Horizontal spindles have outboard bearings. Bearings are spring loaded to prevent lateral movement of the spindle and ensure accurate jointing. Spindles are lubricated by a patented spray system for long life. Cutterblocks are cone mounted.

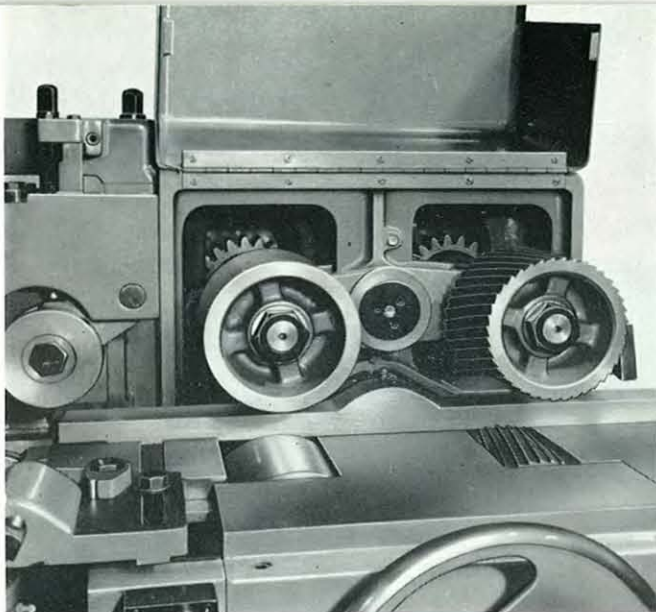
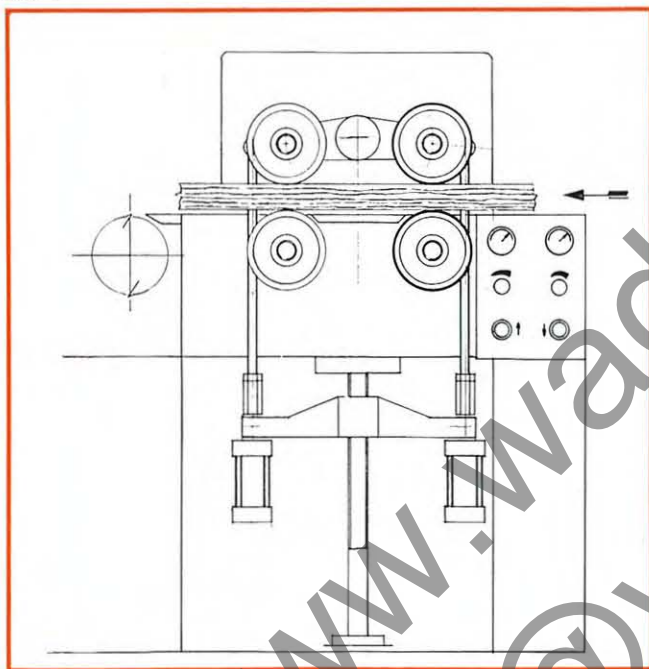

Fig. 11

**Feed (Fig. 11)**

Two top and two bottom rolls feed the timber through the machine. All rollers are readily removable. Both top and bottom rolls swing around a centre pivot and are spring loaded. Vertical rise and fall is by large hand wheel. Bottom roll adjustment is by an eccentric shaft through the end of the machine.

Feed rolls are driven by two-speed motor and three-speed gear box as illustrated overleaf.



**Pneumatic feed (Fig. 11a)**

A pneumatically-controlled feed works arrangement (Patent No. 986651) can be offered.

This arrangement provides pneumatic pressure to the top feed rolls and a control valve and pressure gauge is provided to each top roll to enable instantaneous pressure adjustment to be made. A built-in relief valve ensures constant pressure on the feed rolls regardless of timber thickness variation. Instantaneous loss of traction is achieved by pneumatic lift of the top feed rolls, and a suitable button for this feature is positioned at the infeed end of the machine.

In addition pneumatic lift of feed rolls can be initiated automatically in the event of board overriding or when one or more cutterhead motors are overloaded.

Fig. 11a

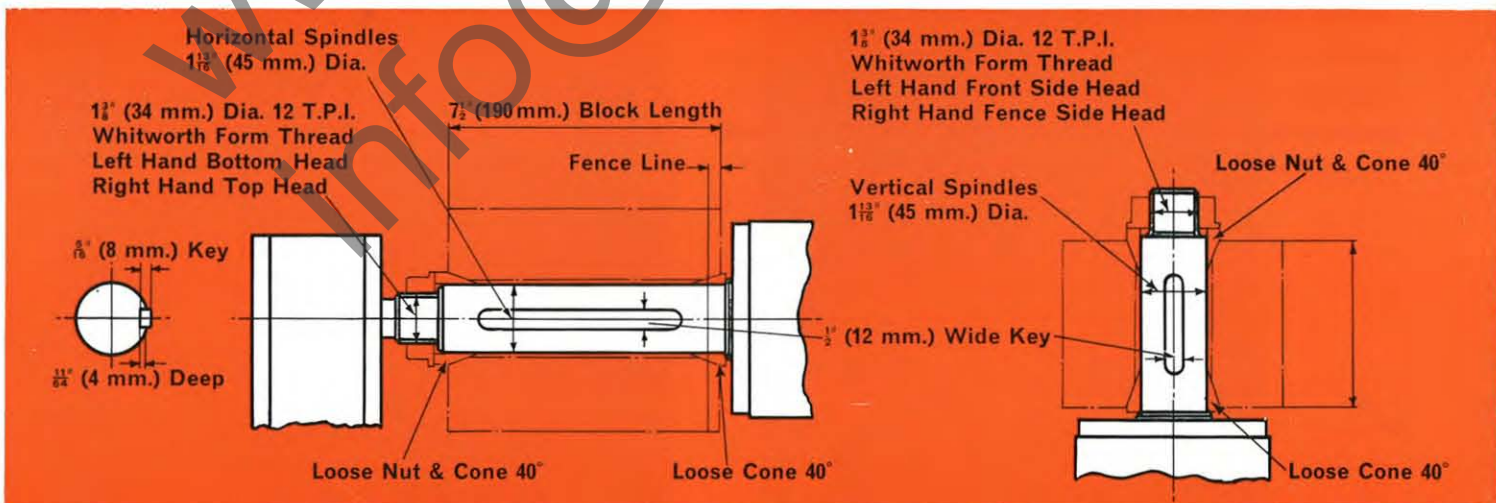

Fig. 12

Alternative spindle ends  $1\frac{1}{8}$ " diameter with loose cones and keyways

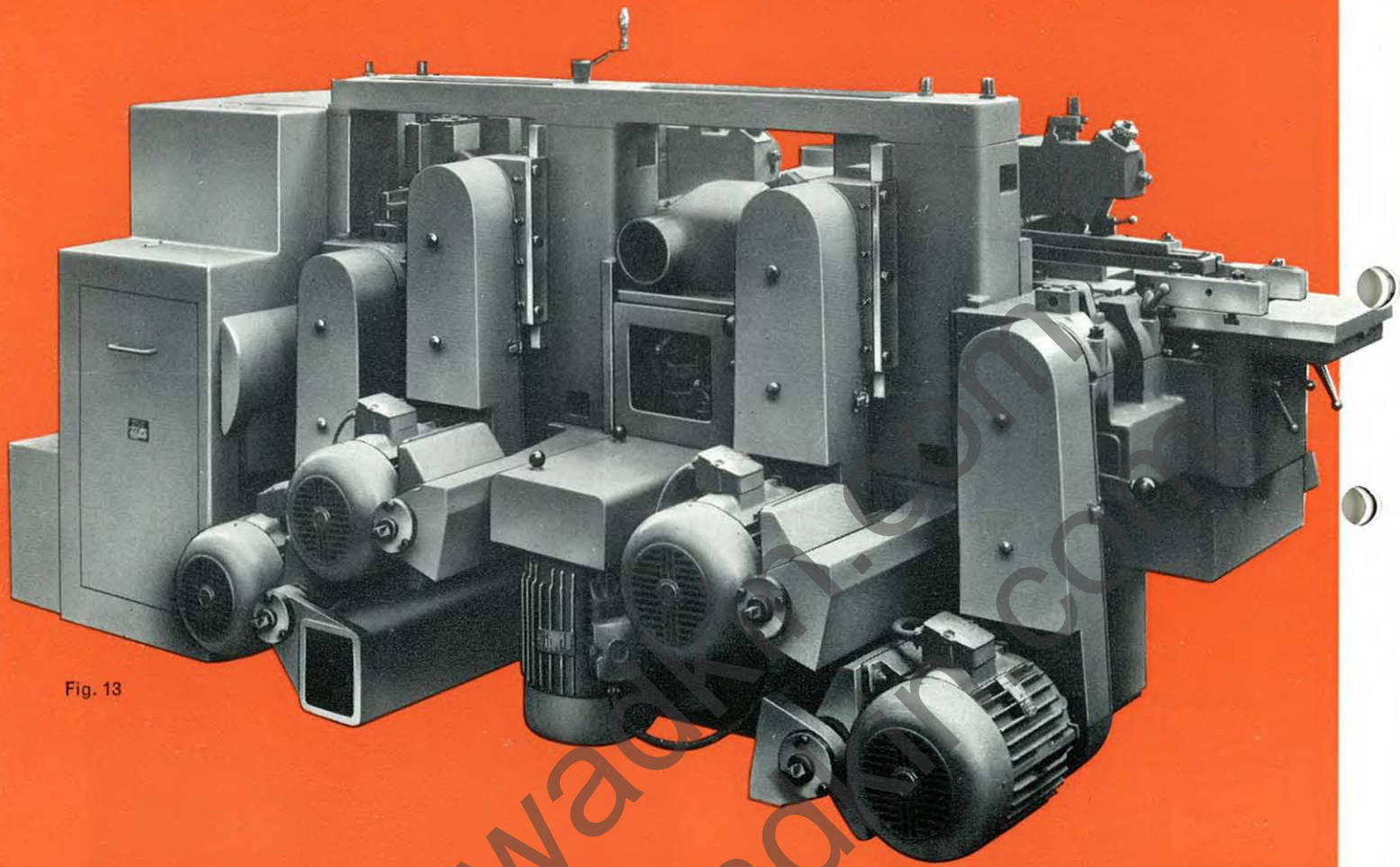

Fig. 13

## The feed drive

The feed rolls are driven by two-speed motor and three-speed oil bath gear box giving six speeds from 20 to 100 f.p.m. All shafts in the gear box and feed works are on ball or roller bearings. Speeds are changed by lever movement in conjunction with the two-speed motor switch. Control of the feed includes jogging and reversing facilities.

**Wadkin**

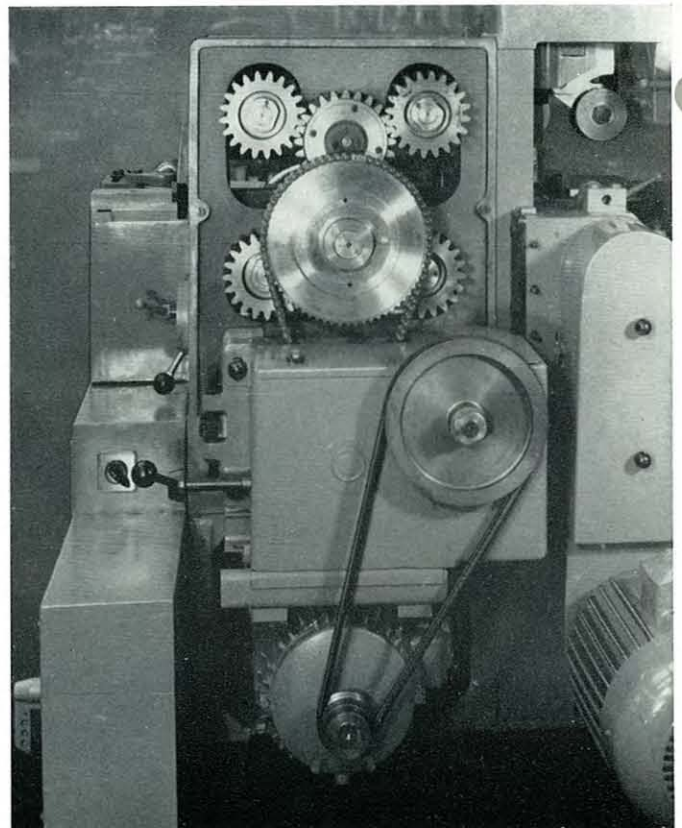

Fig. 14

## The spindle drive

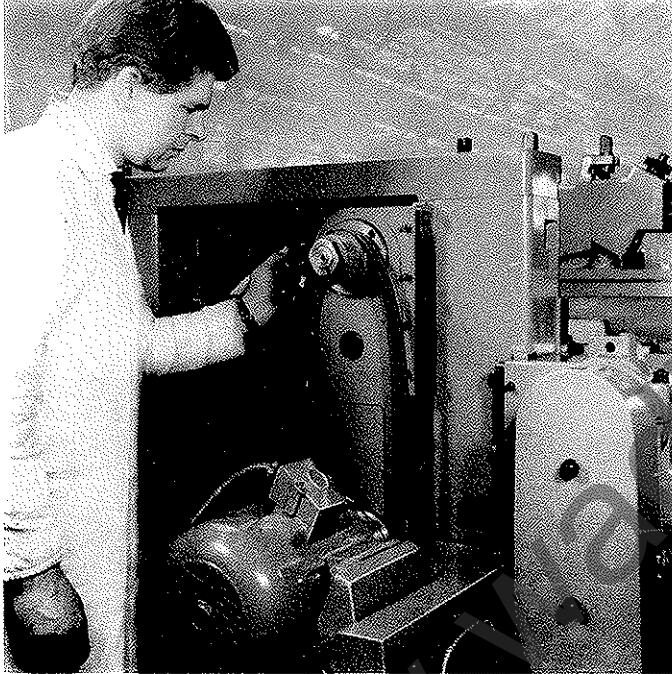

Fig. 16

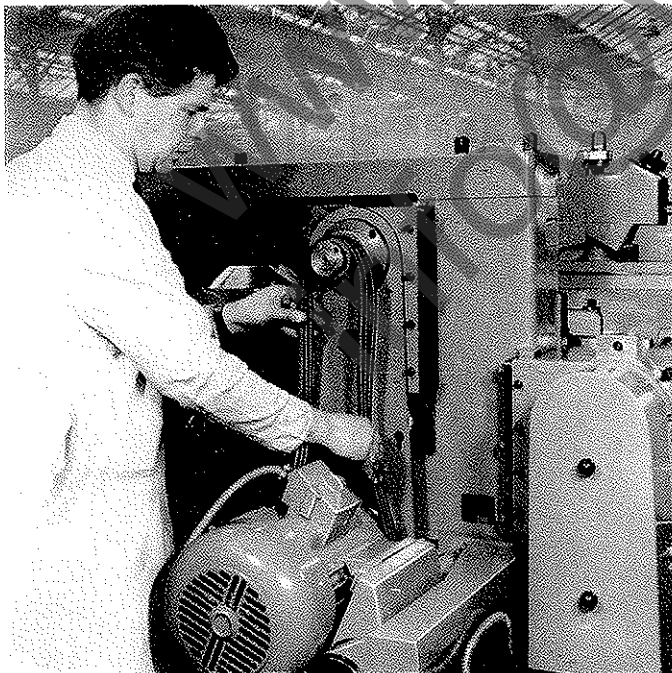

Fig. 17

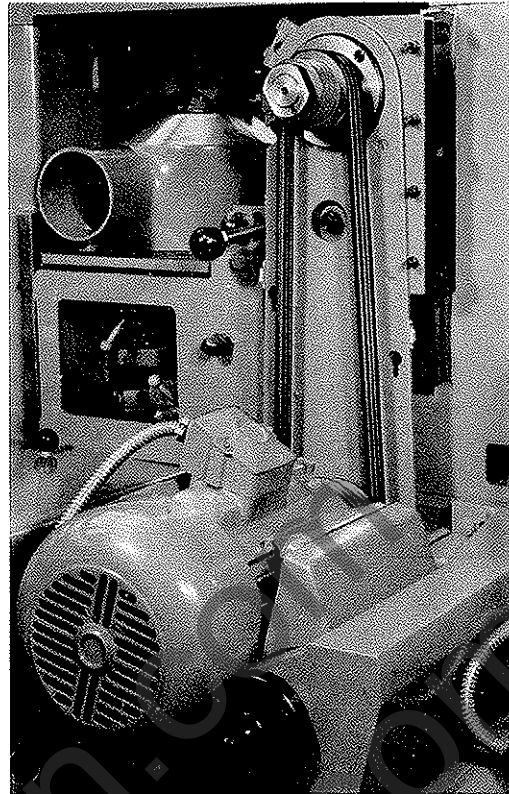

Fig. 15

All cutter spindles are driven through two-step pulleys and vee belts giving speeds of 4,200 and 6,000 r.p.m. Belt changing for speed selection is both quick and easy. Each guard simply lifts off, belts are instantly slackened off by lever, moved to the appropriate pulleys, and the guard replaced in a matter of seconds.

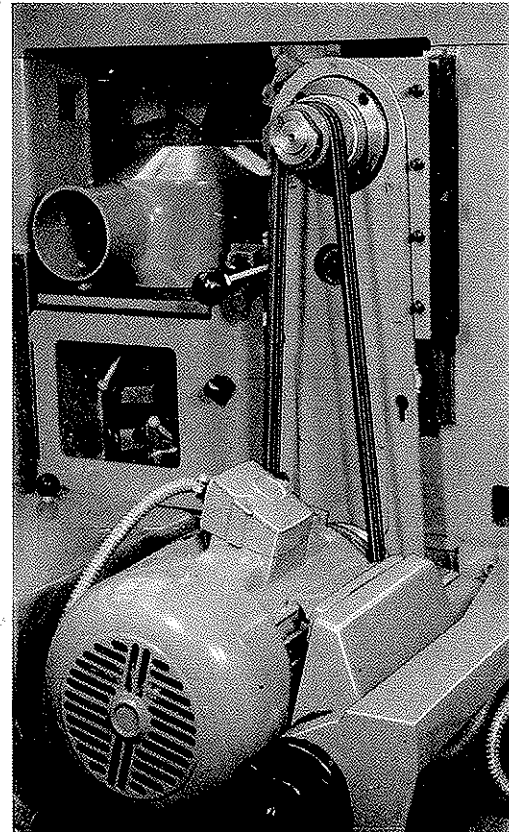

Fig. 18



The aim of jointing is to bring all knives in the block to a precise cutting circle so that under actual cutting conditions all the knives cut equally and leave an equal mark. This ensures either a higher standard of finish at a given speed than is possible from an unjointed block, or the same standard of finish as from an unjointed block at an appreciably higher feed speed. Satisfactory jointing can only be done where the design of the spindle unit, i.e. rigidity of spindle and quality of bearings and mountings, ensures that inherent vibration and movement is reduced to the absolute minimum.

The Wadkin F.B. spindle unit with its deep groove spring loaded bearings and rigid spindle mounting has been specially developed to enable 2-knife jointing to be done with a spindle speed of 4,200 r.p.m., and feed speeds up to 100ft/min (120ft/min to order). 4,200 r.p.m. represents the practical limit for successful high quality jointing on any moulder. Normally several jointing operations can be done before the maximum possible heel is obtained on the knives and the block removed for regrinding.

## The machine is specially

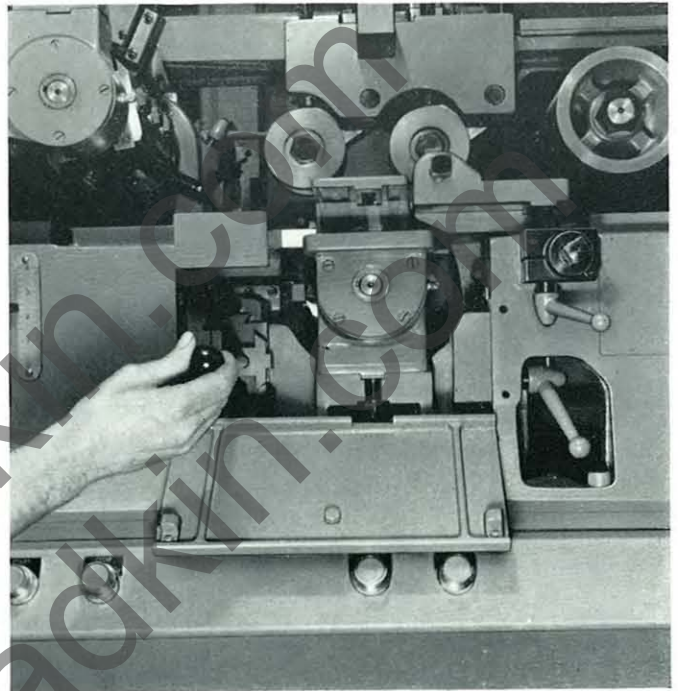

Fig. 19



Fig. 20



Fig. 21



## designed for jointing

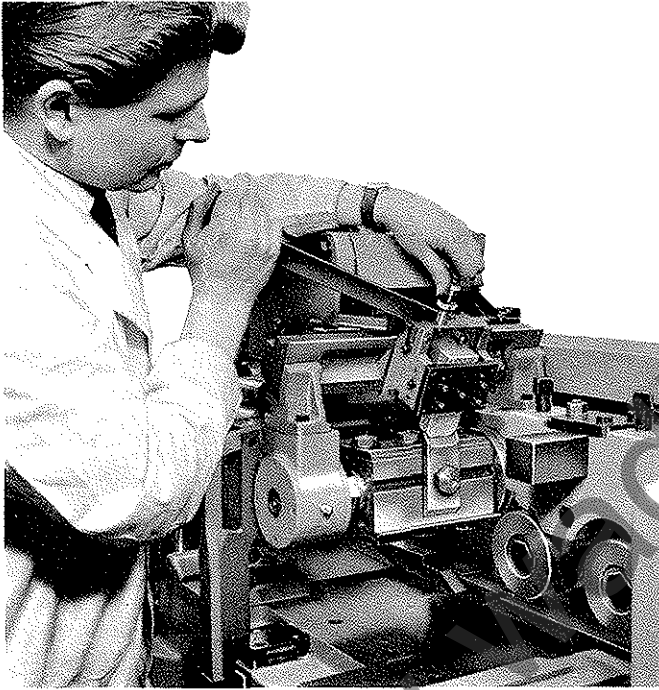

Fig. 22

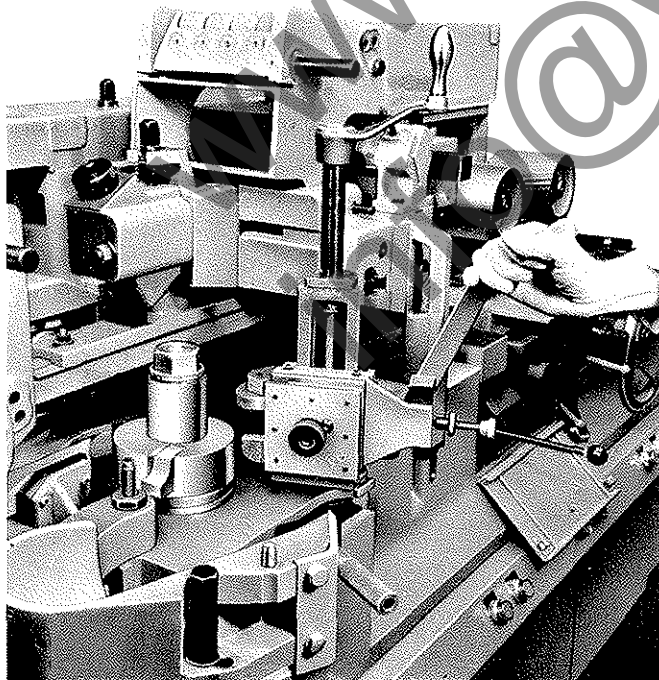

Fig. 23

**Fig. 19. Built-in jointer for first bottom head.**

A jointer for the first bottom head can be built in. The stone is carried in an adjustable slide which is passed across the block by a push-pull action. When not in use the jointer is locked out of position.

**Fig. 20. Straight jointer for the horizontal heads.**

This unit is attached to all horizontal heads as required. The stone is mounted in a holder and fed into the block by screw motion. Holder is on a vee slide and is passed across the block by push and pull action.

**Fig. 21. Straight jointer for side heads.**

The stone holder is mounted on a slide and wound up and down the block by means of a screw and handle.

**Fig. 22. Profile jointer for horizontal heads.**

When jointing profiled cutters, the appropriately shaped stone is fitted into the holder which is adjusted by screw motion to enable the stone to be aligned with the profile of the irons. The stone is brought into contact with the irons by plunger lever, the movement being limited by an adjustable depth stop, a method of operation which completely eliminates snatching as the stone makes contact with the irons.

**Fig. 23. Profile jointer for side heads.**

This unit is quickly bolted to the bed adjacent to the side heads and the operation is similar to that used for the horizontal profile jointer:

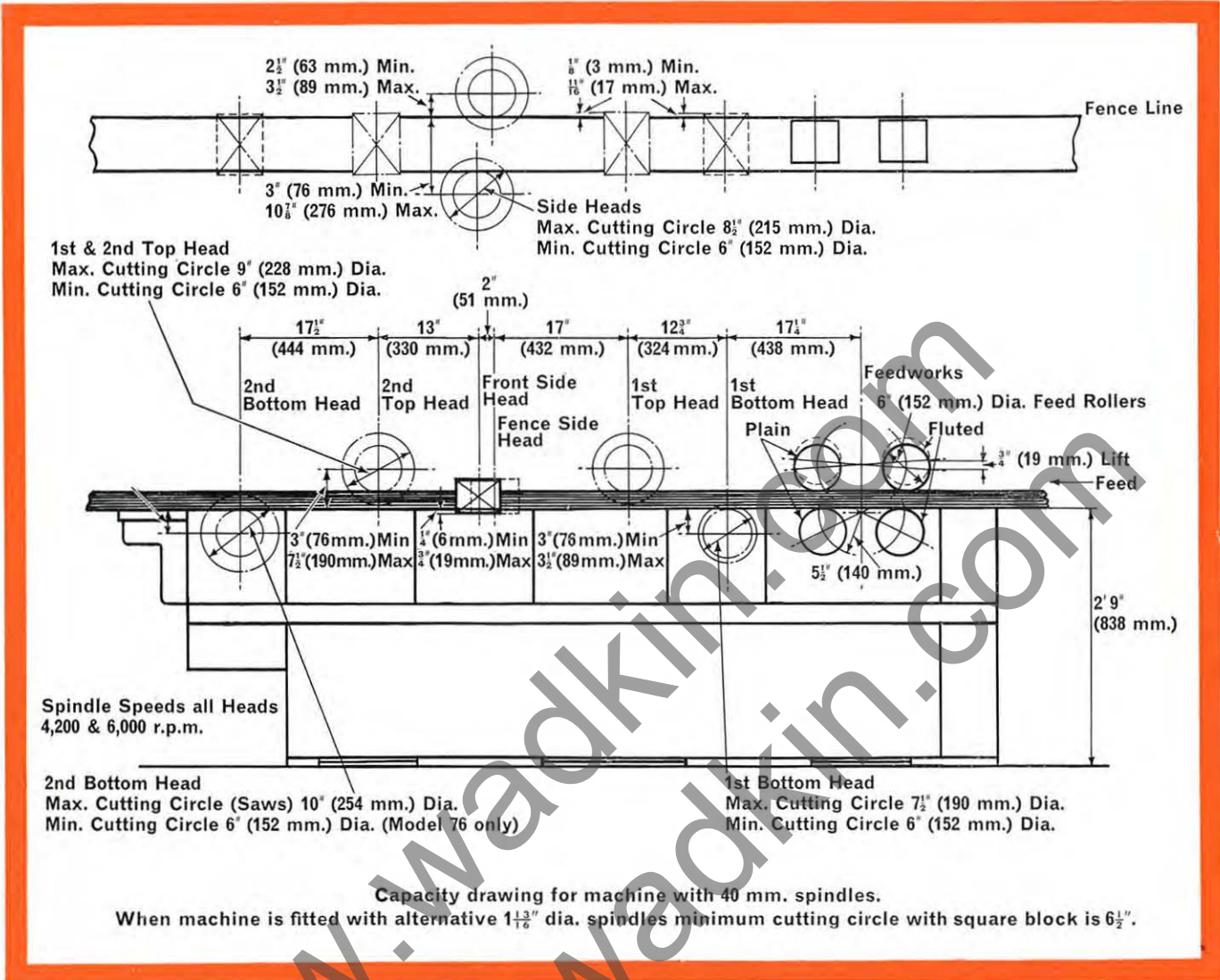

Fig. 27

**DIMENSIONS AND CAPACITIES**

Maximum size of finished work .. .. .	7" x 4"	180 x 100 mm.
Maximum size of rough stock .. .. .	7 1/2" x 4 1/2"	190 x 115 mm.
Feed speeds .. .. .	20, 35, 40, 50, 72, 100 ft/min	6, 10, 12, 15, 21, 30 m/min
Alternative feed speeds (to order) .. .. .	25, 40, 50, 60, 85, 120 ft/min	7, 12, 15, 18, 26 30m/min
H.P. of feed motor .. .. .	6 1/2/3 1/4	
Speed of feed motor .. .. .	1,500/3,000 r.p.m. on 50 cycles	1,800/3,600 r.p.m. on 60 cycles
Speed of all cutter spindles .. .. .	4,200/6,000 r.p.m.	
H.P. of cutter spindle motors: 1st bottom .. .. .	7 1/2 (10 to special order)	
1st top .. .. .	7 1/2 (10 to special order)	
Fence side .. .. .	7 1/2 (10 to special order)	
Near side .. .. .		
2nd top .. .. .	7 1/2 (10 to special order)	
2nd bottom .. .. .	7 1/2 (15 to special order)	
Minimum cutting circle: All heads .. .. .	6"	150 mm.
Maximum cutting circle: 1st bottom .. .. .	7 1/2"	190 mm.
1st top .. .. .	9"	230 mm.
side heads .. .. .	8 1/2"	215 mm.
2nd top .. .. .	9"	230 mm.
2nd bottom .. .. .	10"	250 mm.
<b>Note:</b> Standard square and 4-knife circular blocks have a common cutting circle diameter of .. .. .	6"	150 mm.
Spindle diameter .. .. .	40 mm.	
Spindle cone angle .. .. .	40° included	
Alternative spindle diameter .. .. .	1 1/8"	—
Diameter of feed rolls .. .. .	6"	150 mm.
Yield of feed rollers .. .. .	3/4"	19 mm.
Maximum height .. .. .	49"	1245 mm.
Bed height .. .. .	33"	840 mm.
Floor space .. .. . Model 76	4' 5" x 9' 4 1/2"	1350 x 2850 mm.
Approximate net weight .. .. . Model 76	6,720 lb.	3050 kg.
Gross weight .. .. .	8,960 lb.	4060 kg.
Shipping dimensions .. .. .	255 cu. ft.	7.2 m. <sup>3</sup>