

***The Wadkin K23:  
increased moulder  
efficiency from an  
all-new design***

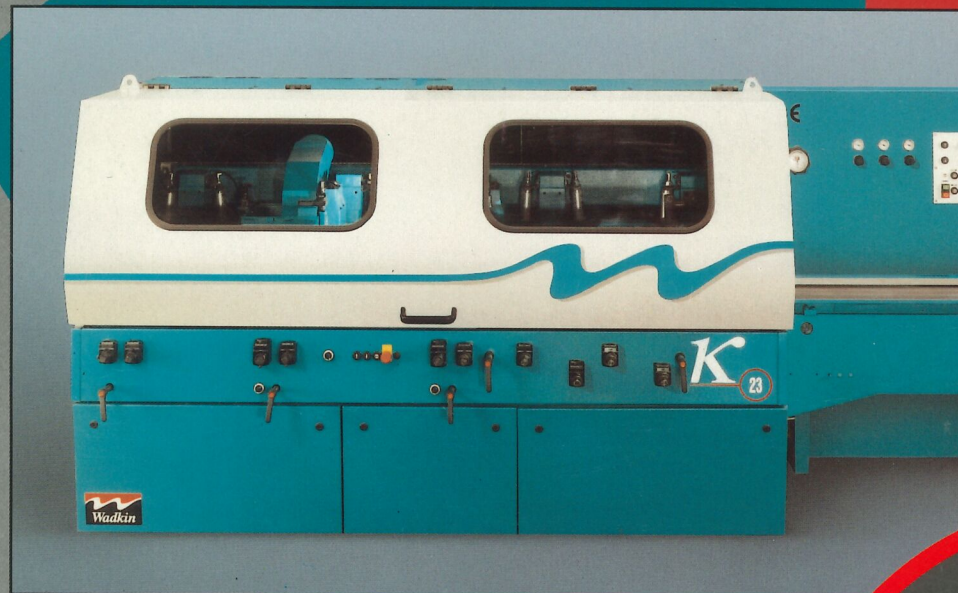

23



Digital read-outs fitted to the top head chipbreaker and pad pressure

# A higher specification comes as standard

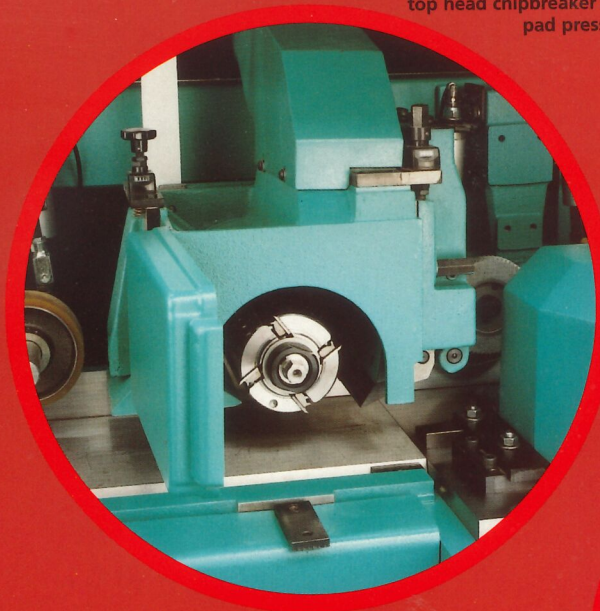

## Faster set-up time: greater output

- Mechanical digital read-outs for quick set-up of the chipbreaker and of pad pressure positions.

With the safety cover closed -

- simultaneous locking and unlocking of all spindle axial movements
- adjustment of all profiling spindles horizontally and vertically
- two speed motorized positioning of the beam and top heads allowing rapid traverse and then fine positioning to an accuracy of  $\pm 0.05\text{mm}$
- 60mm adjustment to the vertical spindles enabling more than one profiling tool to be stacked.
- Radius off-set counters to nearside and top heads

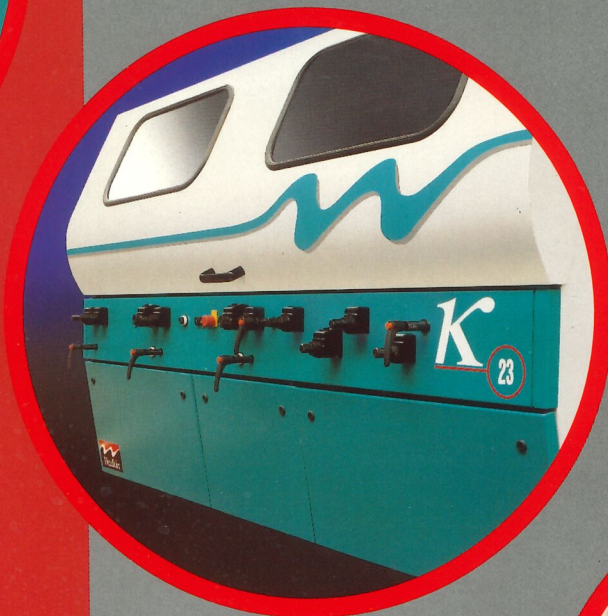

Safe and convenient in-line control locations

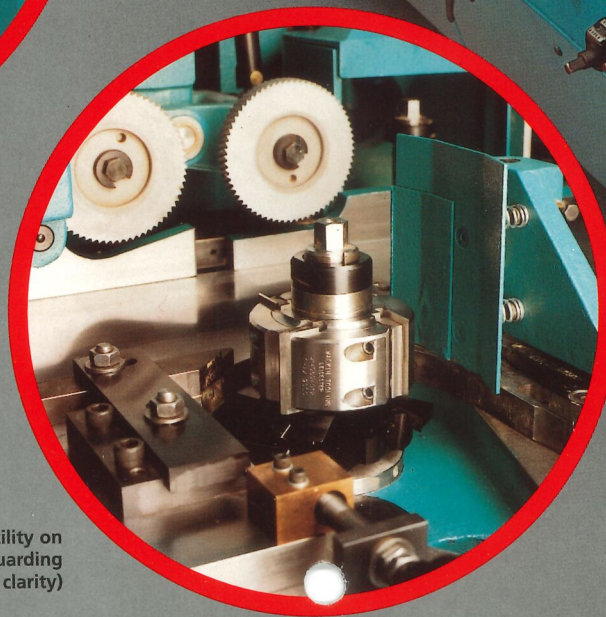

Stacked tooling facility on the side heads (guarding removed for clarity)

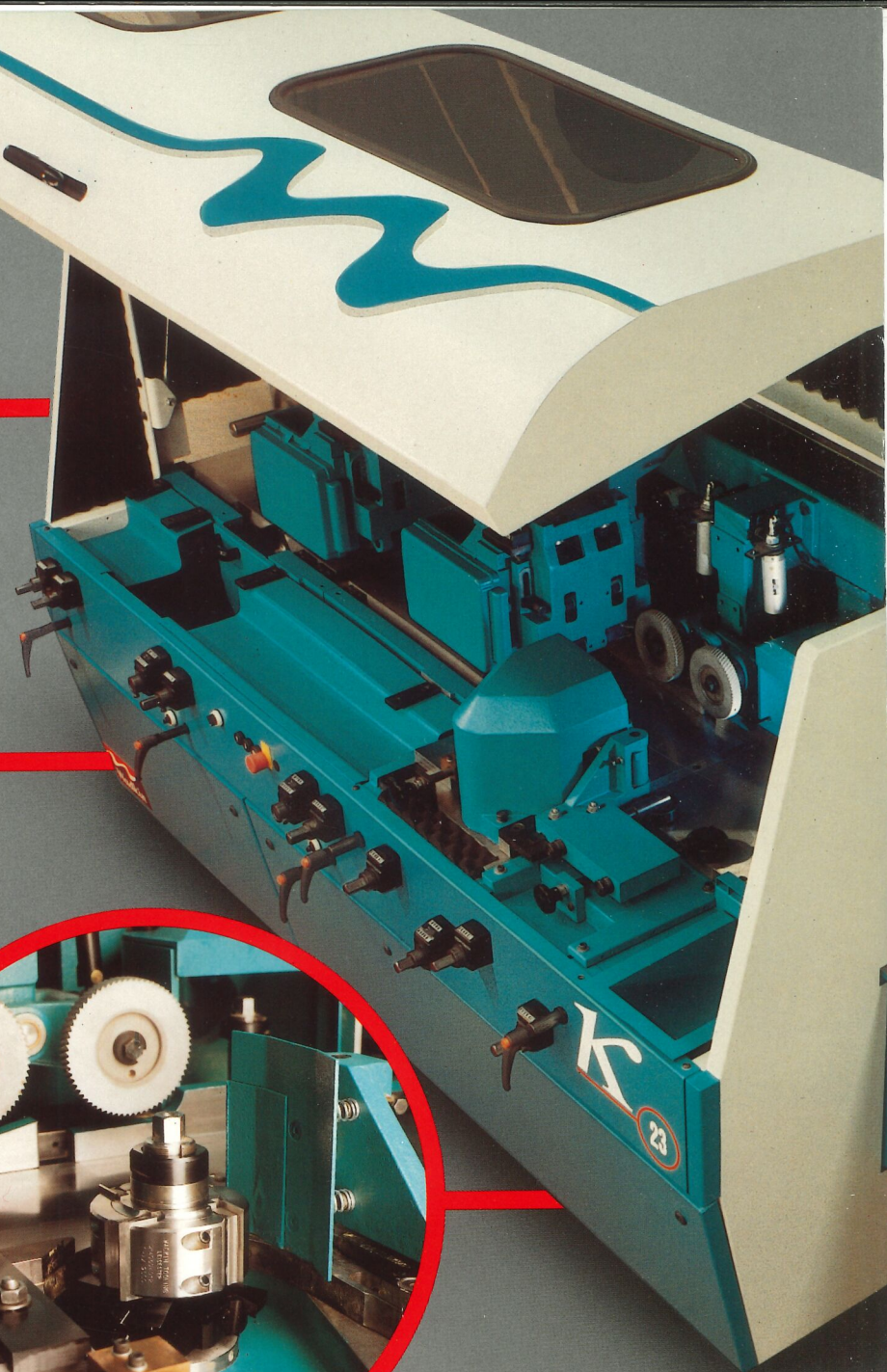

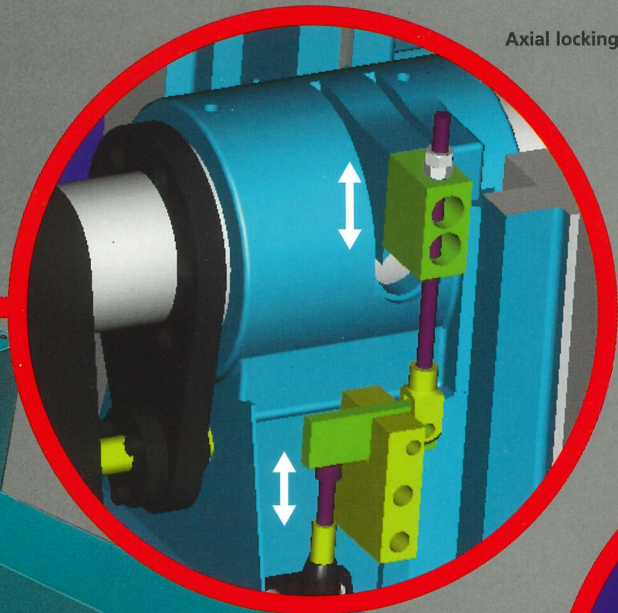
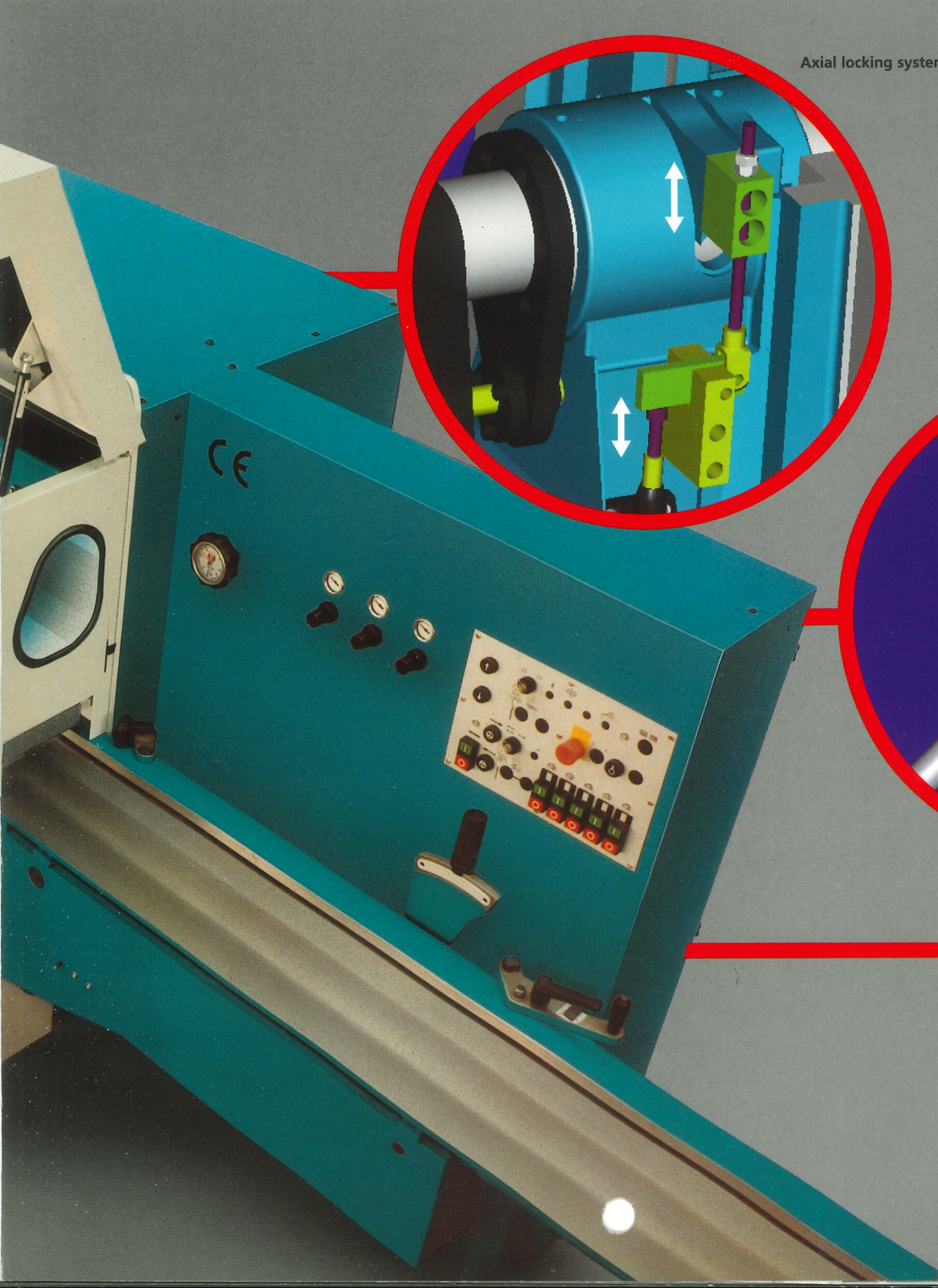

Axial locking system

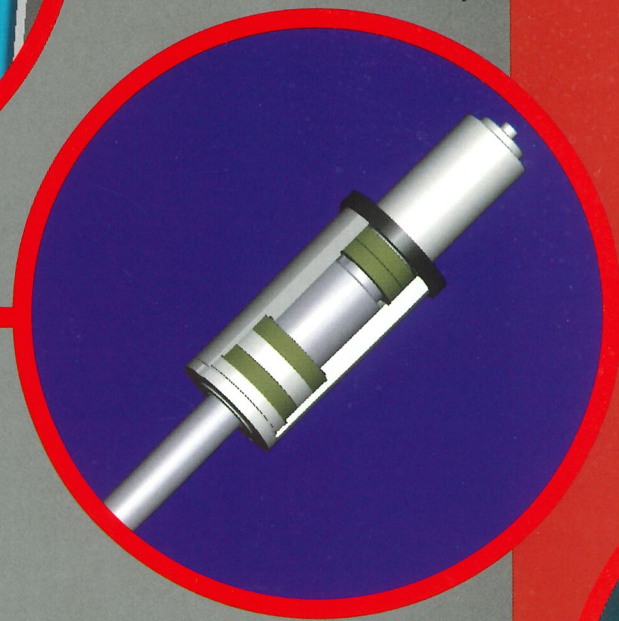

High precision spindle assembly

**Quality and reliability built in**

- Heavy duty precision spindle assemblies
- Through-hardened steel bedplates
- Shaft and gear drive to all spindle movements
- Centralised lubrication



Synchronised operation of top head clutches and beam rise and fall

# T E C H N I C A L I N F O R M A T I O N

## K23

Maximum finished size with 125mm diameter tools		230 x 120mm
Minimum finished size		15 x 6mm
Feed speed		6-22 M/min
Feed Motor Power		3 kW (4 HP)
Spindle Diameters	Standard	40mm
	Optional	1 <sup>3</sup> / <sub>16</sub> "
Spindle speed		6000 r.p.m.
Maximum cutting circles	First bottom head	125mm
	Fence side head	200mm
	Near side head	200mm
	First top head	210mm
	Second top head	210mm
	Second bottom head	200mm
Minimum cutting circles	First bottom head	125mm
	Other heads	120mm
Vertical adjustment	Side heads	60mm
Horizontal adjustment (except first bottom head)		40mm
Motor powers		
Horizontal heads	Standard	5.5 kW (7.5 HP)
	Optional	up to 15 kW (20 HP)
Vertical heads (shared motor)	Standard	11 kW (15 HP)
	Optional	up to 15 kW (20 HP)



As our policy is constantly to improve design, the details given in this leaflet are not to be regarded as binding.

