

Machines as Unique as Your Furniture.

HE HOMAG

Edge banding machines

EDGETEQ S-380 profilLine

EDGETEQ S-500 profilLine

YOUR SOLUTION





Photo: Kettner GmbH & Co. KG / Tom Ziara



Performance and equipment features to suit you

HOMAG is setting standards with this series: Thanks to innovative engineering and durable quality, new landmark achievements are now possible in the field of edge banding in terms of both economy and performance – no matter what the material. Just as impressive: The cost-to-performance ratio and multiple award-winning industrial design which ideally combines ergonomic styling with functionality.

YOUR SOLUTION

MORE: [HOMAG.COM](https://www.homag.com)



Content

- 04 Presentation of the profilLine series
- 08 Modular range of units
- 32 powerTouch Control
- 34 Workpiece infeed systems and return conveyors
- 36 Life Cycle Services
- 38 Technical data

Optimum results and reduced piece costs – no matter what the edging material

The development of the HOMAG profiLine series has provided an innovative answer to growing competitive pressure in the furniture marketplace. Producers in this field are confronted in this day and age with growing material diversity. So any edge banding machine must be both

efficient and capable of material-independent application. The modular profiLine series delivers a shining performance no matter what the discipline – technology, quality, output, function and design – ensuring a fast payback of your investment in practical application.





EDGETEQ S-500 profiLine





The key features of our models

The HOMAG profiLine series is universally suited for any application, with feed rates of 20, 25 and 30 m/min. Select the right units for you from our extensive modular range. Workpiece infeed systems enable efficient, precise infeed of

your workpieces. LOOPTEQ return conveyors provide the ideal complement to the machines.

Optimum edge quality

Edge banding takes place with a wafer-thin glue joint, eliminating the need for finish processing. The quick melt system makes for energy-saving machine operation with minimum heating-up time and a friction-locked connection. The PUR glue system can optionally be used for high-resistance, waterproof and heatproof gluing results on a polyurethane basis.

Modern design and future-oriented technology

Machine operations are both energy saving and environmentally friendly. The machines are equipped with a PC control system without limit switches. The drive system benefits from low-noise, maintenance-free frequency converter technology. The motors are braked by an automatic safety system if required.

Environmentally friendly technology no matter what the material

The EDGETEQ S-500 profilLine is capable of processing any kind of edging material customarily used by the processing industry today. These include for instance solid wood, coil and strip material, melamine, PVC, ABS, aluminium, acrylic and veneer edges. Banding is performed primarily using hot-melt glue, or for special requirements also water-resistant PUR adhesive.



Controlled chip capture

The chips are extracted already in the interior and selectively directed to the dust hood. Greater economy and a longer service life due to reduced wear and lower service costs. Reduced extraction speed drives down energy consumption and costs.

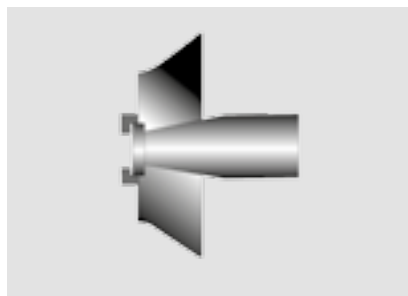

HSK interface – a favored option

The hollow shaft taper (HSK) tool interface ensures a positive locking connection between the tool and motor shaft. Zero tolerances between the motor shaft and tool. This generates optimum trimming quality due to vibration-free tool concentricity.

YOUR BENEFITS AT A GLANCE

- Durable design
- Processing of all kinds of edge materials
- Optimum edge quality
- Enhanced availability through maintenance-friendly machine structure
- Greater economy due to minimized extraction output
- Low energy requirement
- Ergonomically arranged control functions
- Optimum cost-to-performance ratio
- High degree of flexibility in the choice of equipment outfit

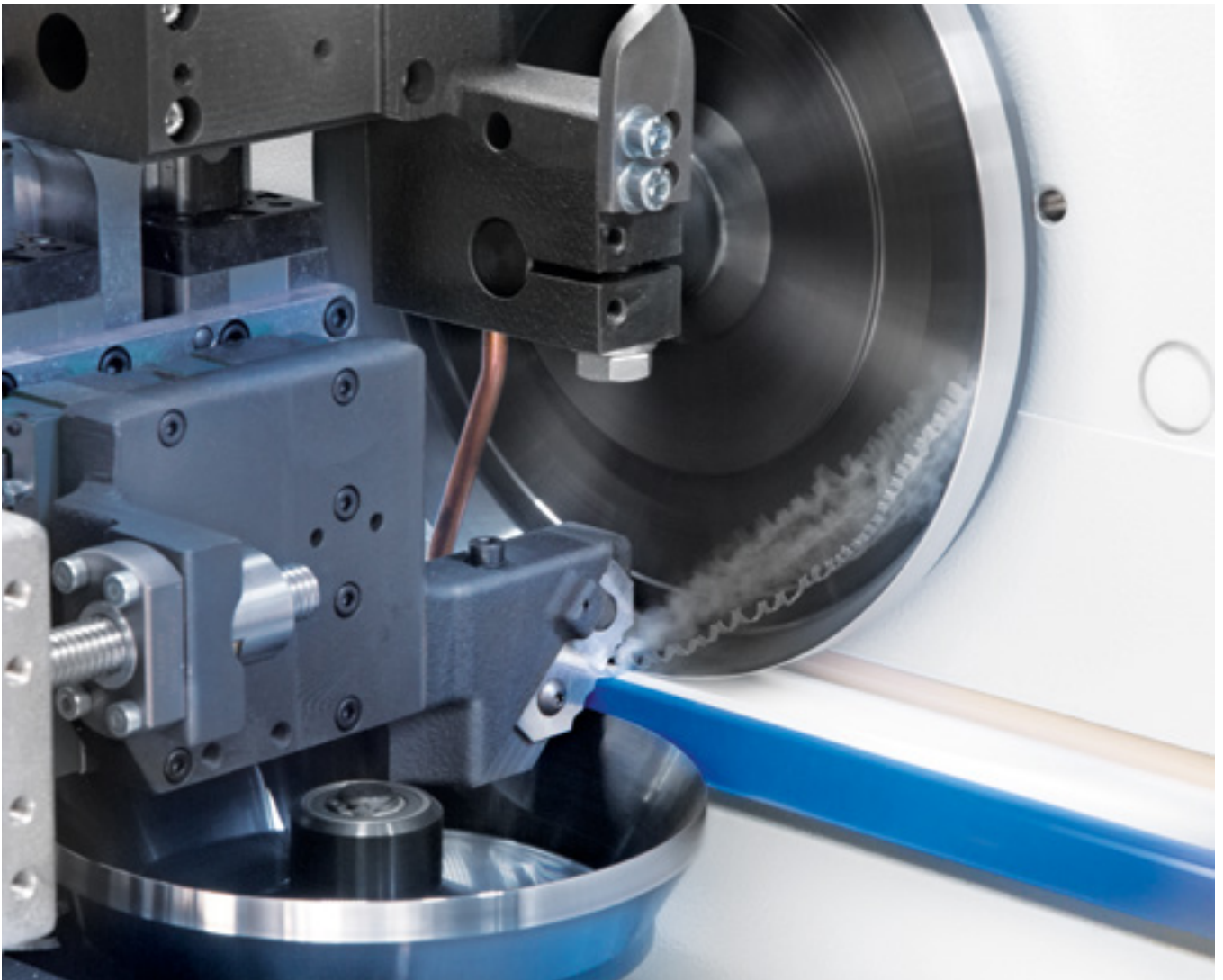

The HOMAG standard: Equipped to your specifications for custom-tailored results

The machines of the HOMAG profiLine series process every workpiece completely. To ensure that the optimum solution is always available for your specific assignment, you can choose your own specific equipment configuration with this series, from the first work step through to the perfect finish.

To ensure that every production step produces top-quality results, all the components are designed for perfect interaction. Their extreme precision and state-of-the-art technology will boost the flexibility and efficiency of your production.

Workpiece feeding

Precise workpiece feeding is a pre-condition to achieve perfect edge quality. Our solutions are your benefit: infeed

fence, infeed stop, sliding carriage or workpiece support.



Infeed stop

For minimum workpiece spacing and safe operation.

With EDGETEQ S-380 profiLine.



Infeed stop

Pneumatically controlled.

With EDGETEQ S-500 profiLine.



Air cushion table

For easy workpiece feeding.



Automatic infeed fence adjustment

Program-controlled precision adjustment with precise infeed fence adjustment by means of servo axis.

With all profiLine series.

Photo = EDGETEQ S-500 profiLine.

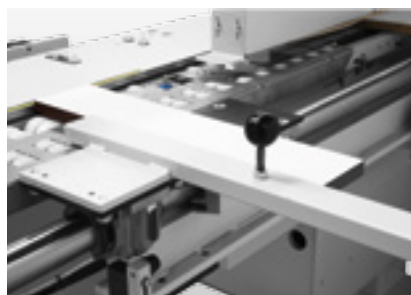

Sliding carriage

Robust linear guiding system to secure rectangular workpiece feeding.

With all profiLine series.

Photo = EDGETEQ S-500 profiLine.

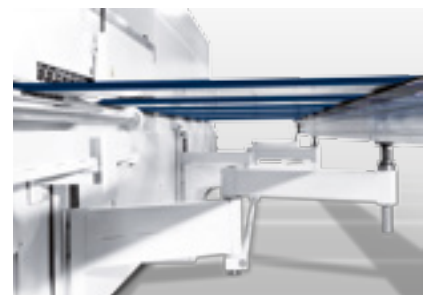

Scissor-design workpiece support

The workpiece support in scissor-design is conveniently extendable to 1,000 mm.

With all profiLine series.

Spraying units

Spraying units help to improve edge quality throughout the complete processing. Separating agent and antistatic agent avoid that hot melt glue residuals and plastic chips adhere to the workpiece. Cleaning agent help to easily remove

glue residuals. Lubricant is applied to protect sensitive surfaces before trimming and to prevent gloss marks on the workpieces.



Spraying unit for the application of lubricant

To achieve optimum processing quality even with sensitive surfaces. With all profiLine series.



Spraying unit for the application of separating, antistatic and cleaning agent

Prevent the adhesion of hot melt glue residues or dissolve them on the upper and lower side of the workpiece. With all profiLine series.

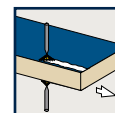
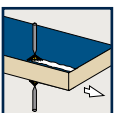

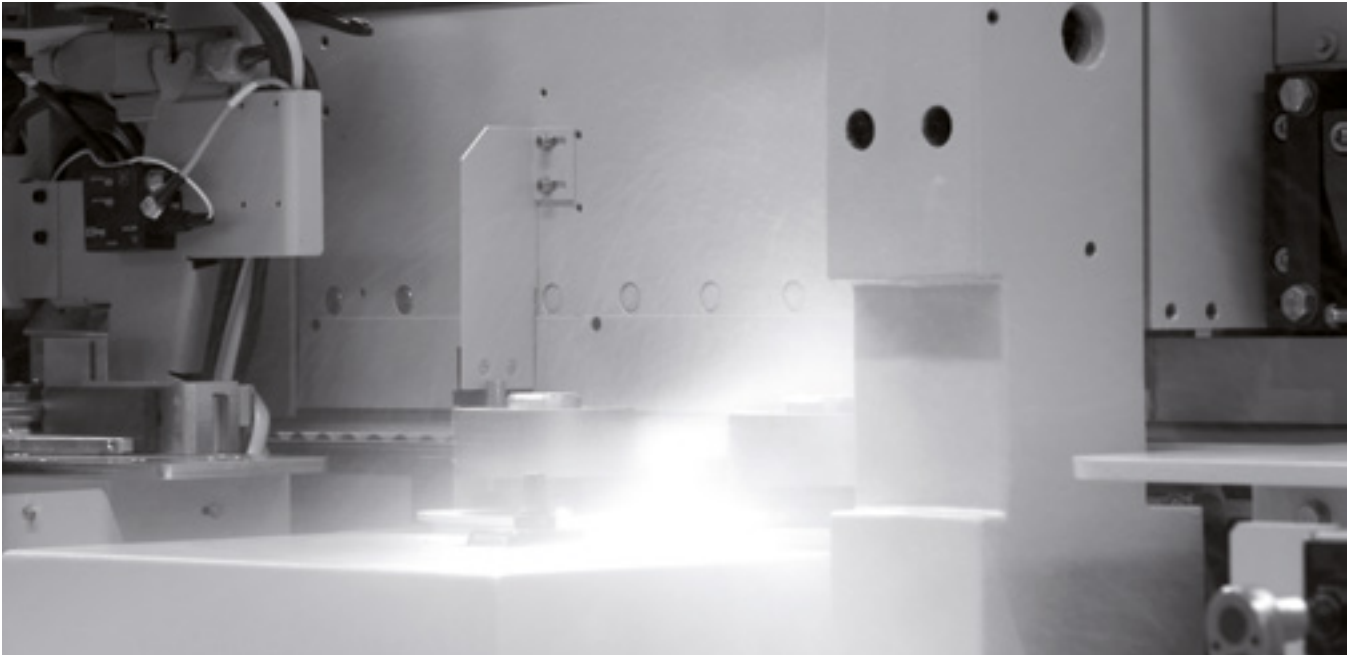

Joint trimming units

The HOMAG joint trimming units provide the perfect basis for splinter-free glue joints with a consistently high standard of product quality.

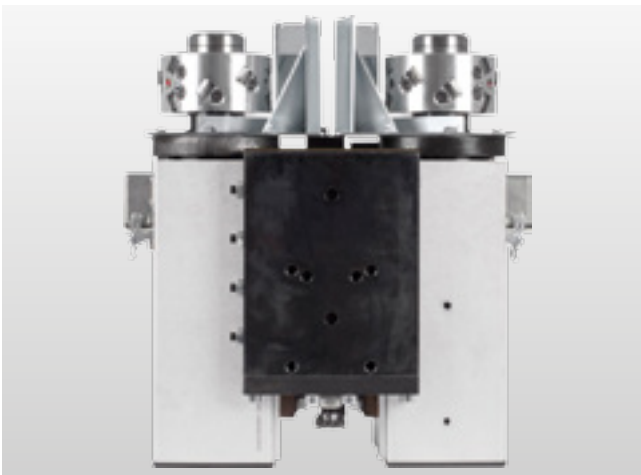

Joint trimming unit

Perfect cut and high operating life due to diamond tipped tools for an optimum edge joint quality. The diameter is 100 mm.

With EDGETEQ S-380 profiLine.

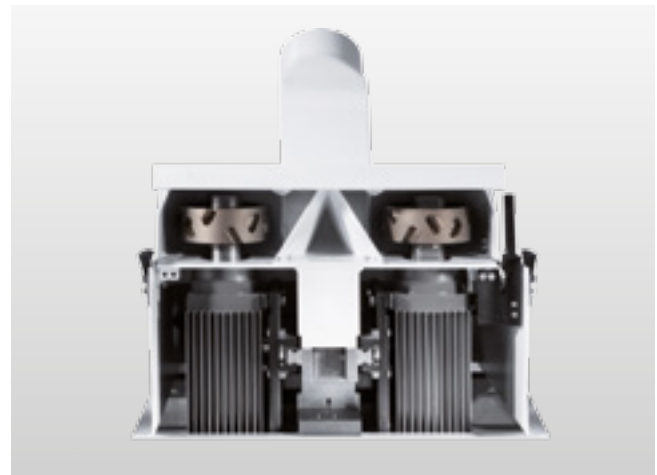

Joint trimming unit

This unit permits a high level of processing precision, is extremely hardwearing and is also designed to ensure an above-average service life. The diameter of the low-noise flying chip-optimized tool (I-system) is 125 mm.

With EDGETEQ S-500 profiLine.

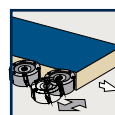

Gluing units – reliable hot melt glue application

HOMAG gluing units are ideal for a fast, positive-locking glue bond. An EVA pre-melting unit comes as standard. The heated glue roller ensures an optimum gluing temperature. The magazine height adjustment (EDGETEQ S-500 profilLine) permits different edge heights to be processed with a

consistent workpiece thickness. On request, the gluing unit can also be individually equipped with a PUR pre-melting unit – allowing rapid changeover between two different colors or PUR.

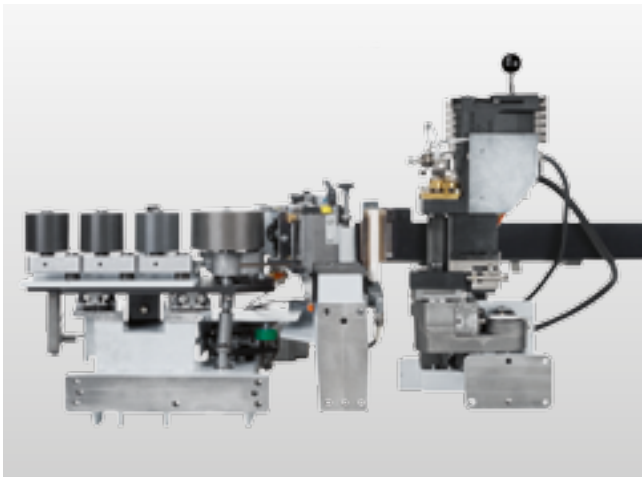

Gluing unit

Quick-change application unit.

Can process PUR granulate.

Photo = EDGETEQ S-380 profilLine.

YOUR BENEFITS AT A GLANCE

- Short heating-up time by sensed level control (2 levels selectable)
- Easy removal of the application unit with quick-release lock
- Pre-melter for melting hot-melt glue as required either manually or automatically
- Glue roller with integrated heating guarantees constant temperature and viscosity for all workpiece thicknesses
- Electropneumatic glue roller and tank clamping prevents glue soiling on the trailing edge of the workpiece
- Tracing pad prevents wear of the application roller and ensures a consistent glue film thickness
- Glue roller lift-off on feed stop

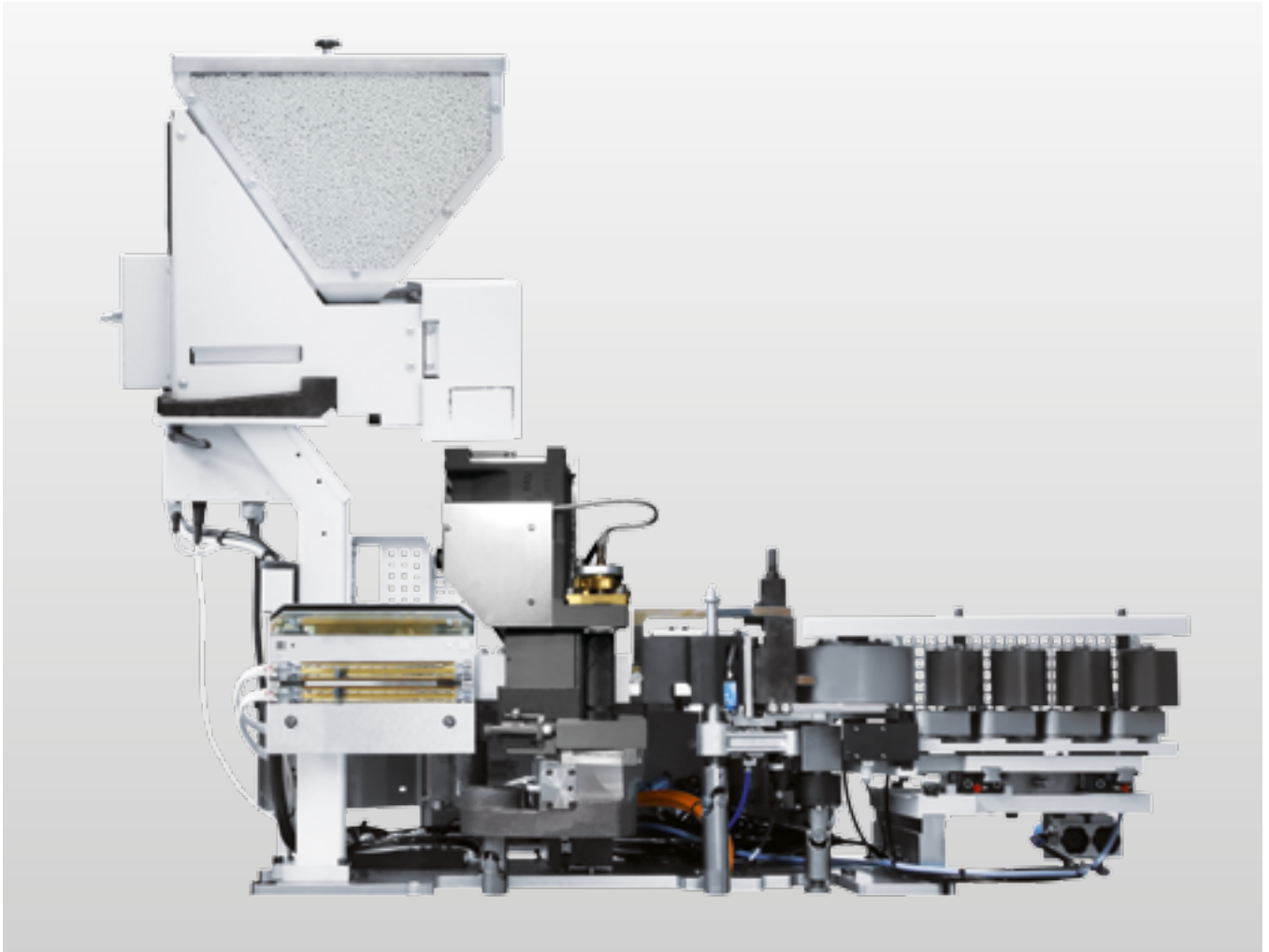

Hot-melt gluing unit

For processing coil material from 0.3 – 3 mm. EDGETEQ S-500 profilLine.

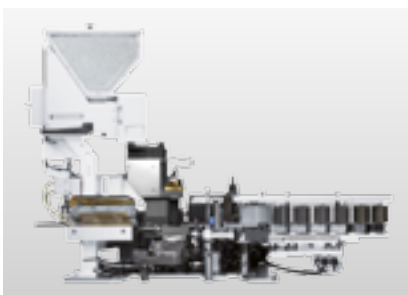

Hot-melt gluing unit with solid wood package

For processing coil material from 0.3 – 3 mm and solid strips of up to 20 mm. With EDGETEQ S-500 profilLine.

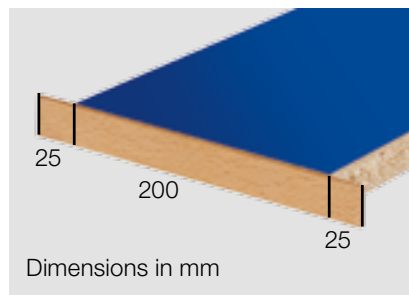

Previous gluing technique

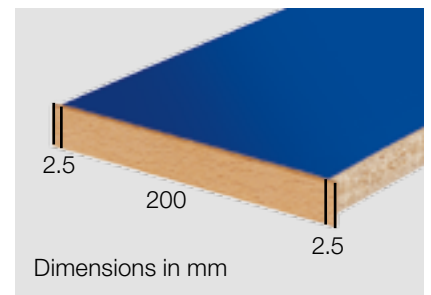

Optimized gluing technique with servo edge feed

Edge feed with a precision of +/- 2 – 3 mm at the leading and trailing edge to reduce edging material waste. With EDGETEQ S-500 profilLine.



Processing PUR glue

To cope with the special requirements when it comes to humidity- and heat-resistance the profilLine models allow the use of PUR glue with a standardized glue application system from above.

Photo = EDGETEQ S-500 profilLine.



PUR pre-melting unit

Melting output 6 kg/h.
With EDGETEQ S-500 profilLine.



PUR pre-melting unit

Melting output 2.5 kg/h.
With EDGETEQ S-380 profilLine.



Service station

- Pre-heating and cleaning station for the application unit QA65N with a storage area
 - High flexibility through the use of 2 vacuum containers, each for one QA65N application unit or a PUR pre-melting unit 2.5 kg/h
 - No vacuum pump (Venturi nozzle) and no nitrogen required
- With EDGETEQ S-380 profilLine.

Systematic gluing units

To achieve a perfect gluing it is decisive that entirely different factors interact in an optimum way. The HOMAG panel pre-

heating, application unit, quick clamping device, melting unit, magazine and pressure zone match perfectly.



Workpiece pre-heating

High-strength gluing due to an optimum workpiece pre-heating.

With all profilLine series.

Photo = EDGETEQ S-380 profilLine.



Pressure zone

Pressure zone (up to 20 mm) for an optimal glue joint.

With all HOMAG profilLine series.



Wide solid strips

Extra wide magazine with high capacity for solid strips and optimum access to reload.

With all profilLine series.

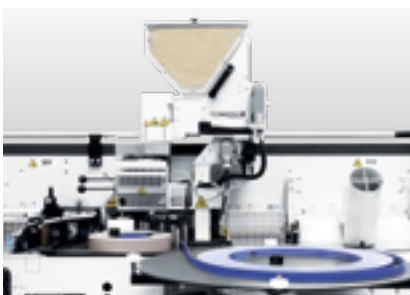

Melting unit with granulate tank

For storage and pre-heating of hot melt glue granulate.

With EDGETEQ S-500 profilLine.

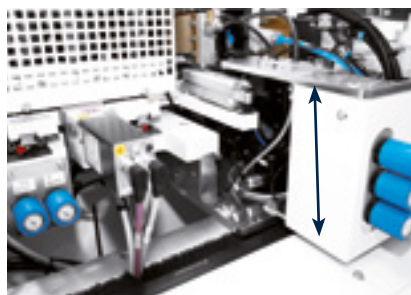

Magazine height adjustment

For processing coil material from 0.3 – 3 mm and solid strips of up to 20 mm. Different edge thicknesses can be processed with a single edge height.

With EDGETEQ S-500 profilLine.

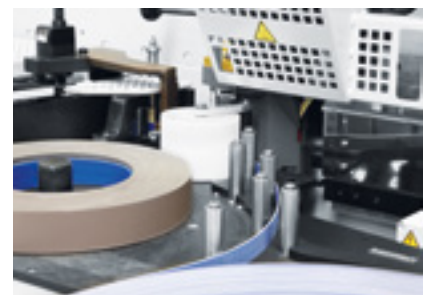

2-coil magazine

Edge feeding and 2 horizontal coil magazines. Servo-driven edge feeding to reduce edge material waste.

With EDGETEQ S-500 profilLine.

Zero joint technology – the Quantum Leap in Furniture Production

Premium quality edge banding: Zero joint technology has fundamentally transformed furniture manufacture. The optical “zero joint” is the new quality standard for edge processing in

the furniture and interior fittings trade. Using both the airTec and the laserTec* method from HOMAG, you can produce furniture with an unprecedented standard of edging quality.



airTec unit

The HOMAG's answer to the growing demand is an innovative, more efficient and resource-saving airTec solution. The nerve center of the airTec unit is a rotation air heater which not only enhances efficiency but also operates with significantly lower noise emissions.

With all HOMAG profilLine series.

Photo = EDGETEQ S-380 profilLine.

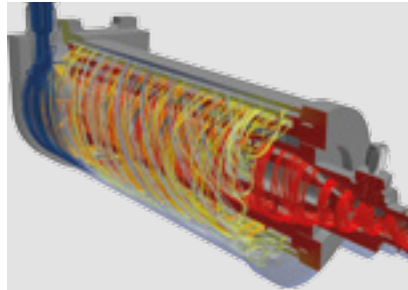

Edge banding with “no joints”

The airTec method bonds the edging to the panel using hot air. This requires the use of special edges. These comprise a decor layer and a function layer. The HOMAG airTec unit melts the function layer at an even temperature and flow rate and bonds it perfectly to the narrow surface.

BENEFITS OF AIRTEC

- Reduction of noise
- More efficient, resource-saving operation
- Even air flow for high quality
- Rapid changeover between airTec and traditional gluing technology
- Simple operation with powerTouch

* For patent-related reasons this may only be used in Germany with Rehau edges.

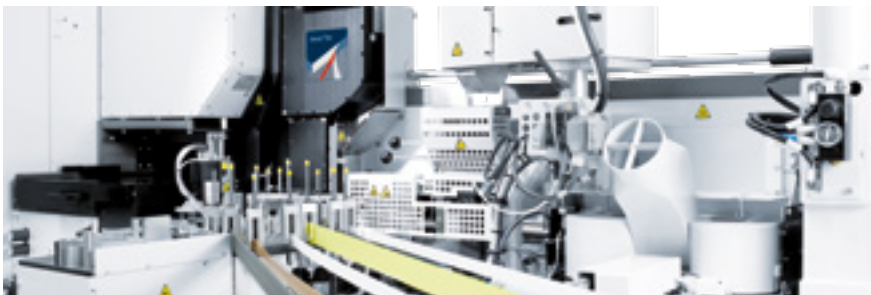

laserTec – Next Generation for the entire laser edge spectrum

laserTec – Next Generation can be used to process all customary types of edging such as PVC, ABS, PP, PMMA, wood veneer or melamine. The laser-active layer is individually adjusted in line with product and customer requirements.

Optimum economy due to

- Reduced rejects quota
- Simple operating processes
- Low additional costs
- Maximum level of availability
- Reproducible production parameters
- Resource-saving production
- Extreme production reliability

Flexibility for gluing

The EDGETEQ S-500 offers three gluing processes. As well as airTec, both EVA and PUR can be used on one machine. The respective process can be selected according to requirements. The change from airTec to EVA or airTec to PUR takes place automatically without any manual intervention.

Snipping units for cutting the overhang on the front sides

The snipping units prepare the workpieces perfectly for subsequent trimming operation.

The face side can be snipped either straight or with chamfer.

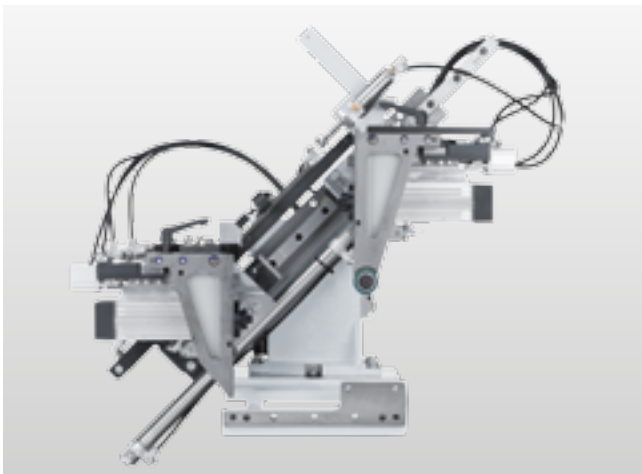

Snipping unit

Exact snipping cut via a robust snipping unit with a highly precise linear guide and workpiece gap optimization (optional) to achieve higher output in the same processing time. Soft-touch function for optimal snipping results even at high speeds.

With EDGETEQ S-380 profiLine.

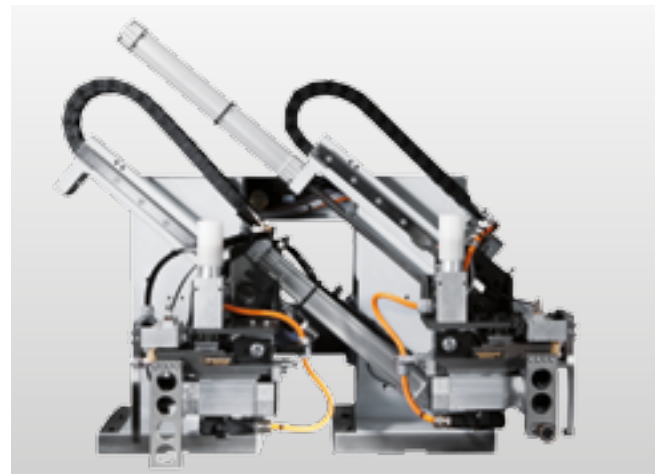

Snipping unit HL81

For a clean snipping cut of overhanging edges on leading and trailing workpiece edges using the drawing cut technique.

With EDGETEQ S-500 profiLine.

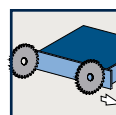
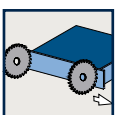

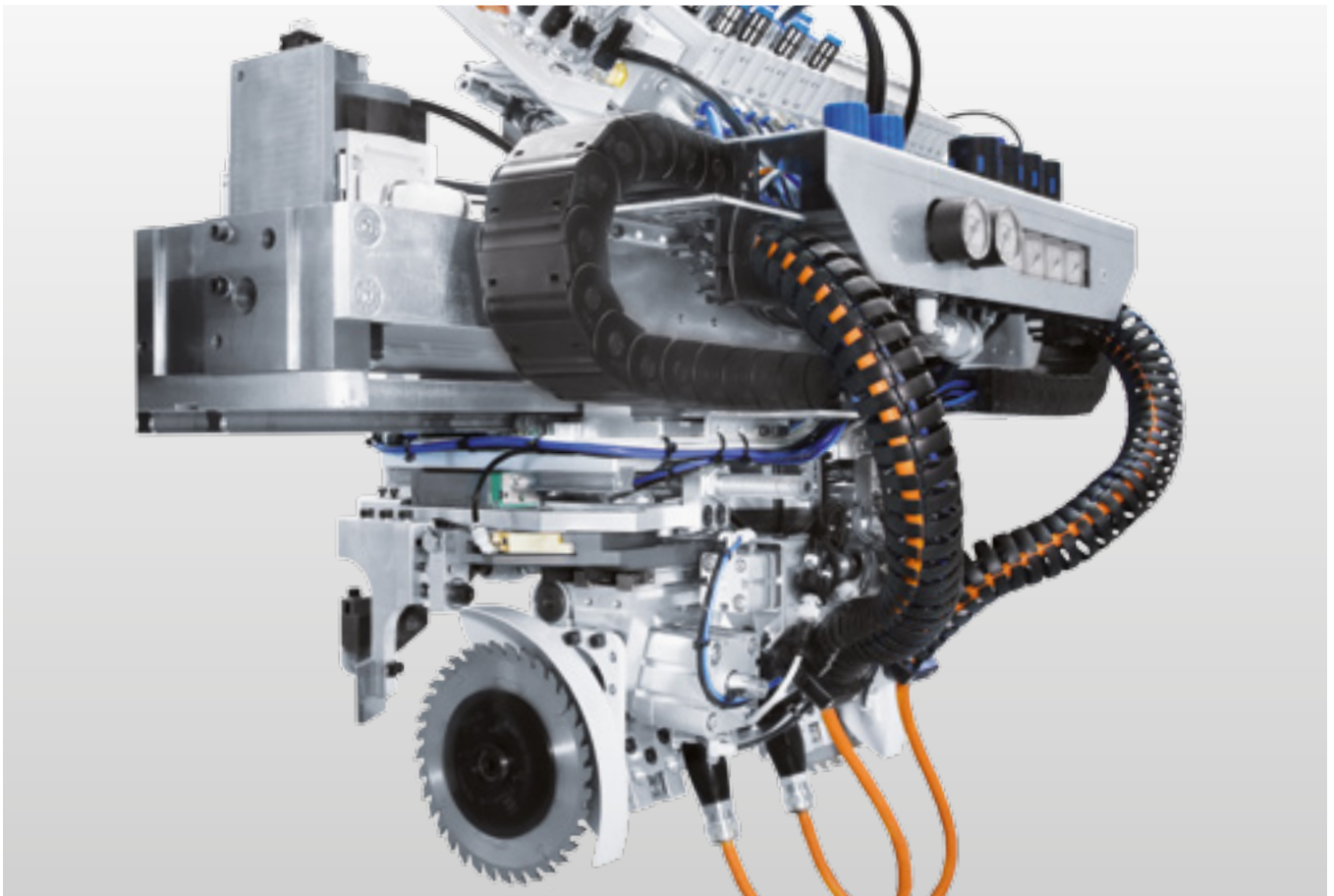

Snipping units PK25 and PK30 as well as snipping units SK25, SK30 and SK35

For snipping the edge overhang at the leading and trailing workpiece edge with stationary snipping stop to protect sensitive workpieces from damage. PK snipping units are driven pneumatically. SK snipping units are driven by servo motor.

With EDGETEQ S-500 profilLine.

Photo = Snipping unit PK30



Snipping units

Feed speed

- PK25 / 30 = 25 / 30 m/min
- SK25 / 30 / 35 = 25 / 30 / 35 m/min

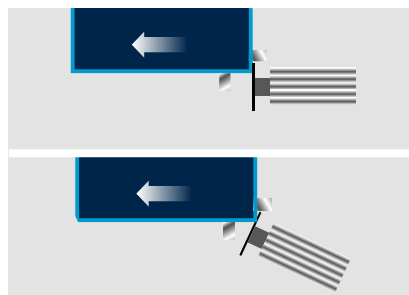

Automation as standard

Programmable chamfer/straight snipping motor adjustment for fast changeover between straight snipping and snipping with chamfer.

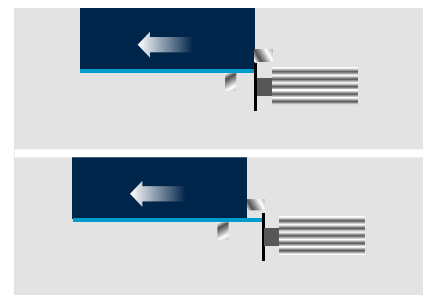

Automation as standard

For fast changeover between flush snipping (e.g. of solid strips or inlay shelves) and snipping with overhang (e.g. for finish trimming with profile trimming unit).

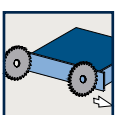

Trimming units for flush trimming

With the rough trimming unit and the fine trimming unit HOMAG offers the right solution for the processing of projecting edges. The trimming units are equipped

exclusively with tools which capture the chips controlled. This and the HOMAG-patented HSK interface ensure a high standard of processing quality and a long tool life.

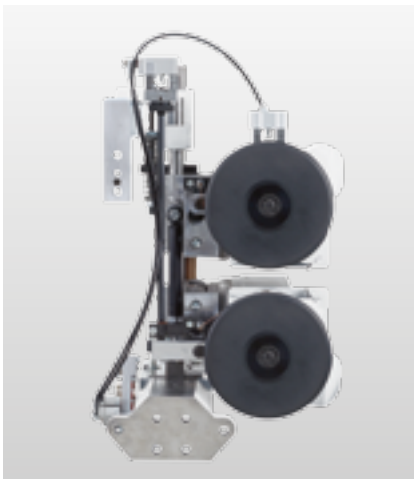

Rough trimming unit

For rough trimming of all common edge banding materials.
With EDGETEQ S-380 profilLine.



Rough trimming unit

For rough trimming the upper and lower edge overhang.
With EDGETEQ S-500 profilLine.

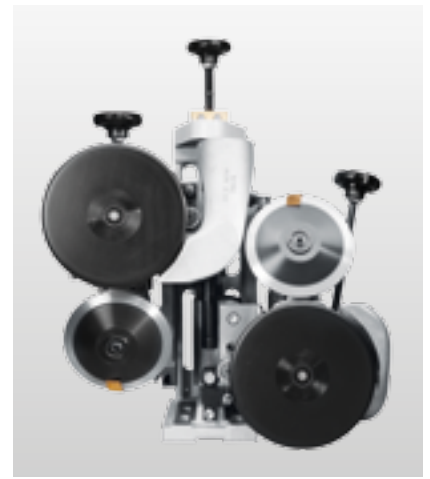

Fine trimming unit

For trimming chamfers and radii with optimized chip extraction and manual adjustment.
With EDGETEQ S-500 profilLine.

Automation to suit every need

Automatic changeover from flush trimming to trimming with projecting edge using 2-point-adjustment.

Automation to suit every need

Stepless chamfer/radius adjustment for rapid changes between processing operations, e.g. from 0.4 mm to 2 mm edge.

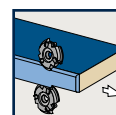
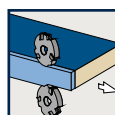
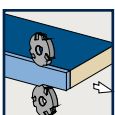

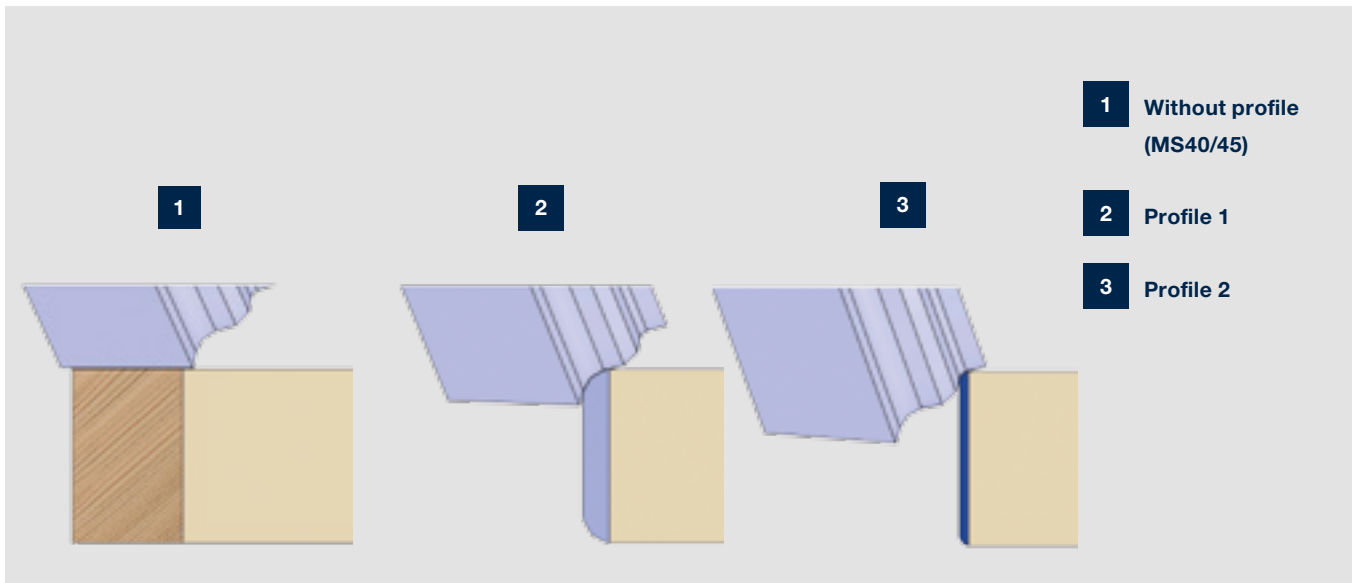

Multi-trimming unit MF21

For automatic changeover between different profiles, e.g. chamfer 20°, R2 and R3.

With EDGETEQ S-500 profilLine.

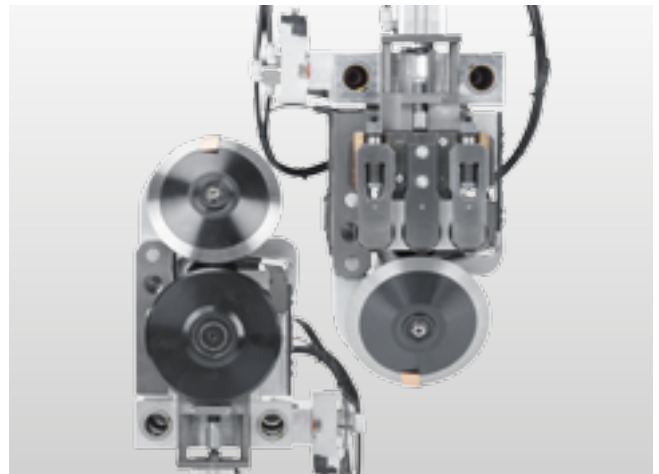

Multi-stage trimming unit MS40/45

Fully automatic adjustment between 3 different profiles by means of servo motors.

Image shows nesting package.

With EDGETEQ S-380 profilLine.

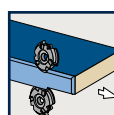
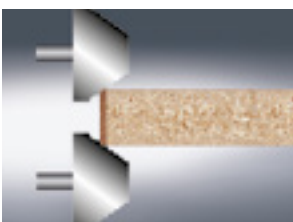

Profile trimming units for EDGETEQ S-380 profilLine

HOMAG profile trimming units are universal. The user has the choice to adjust the units manually or to control them via program. High precision adjustment up to speeds

of 20 m/min. Our profile trimming units permit both corner rounding and trimming of upper and lower projecting edges.



Profile trimming unit FF20

For rounding corners on thick PVC edges, as well as top edges on post-forming and soft-forming parts. Equipped with an automatic adjustment to switch between thin and thick edges. Workpiece thickness up to 60 mm.

With EDGETEQ S-380 profilLine.



Multifunctional trimming unit MF 50

Trimming of the edge overhang on top and bottom side as well as contour trimming on the front and rear edges. Equipped with an automatic adjustment to switch between thin and thick edges. Workpiece thickness up to 60 mm.

With EDGETEQ S-380 profilLine.

Automation to suit every need

Adjustment to two different radii and automatic adjustment of the tracing rollers.

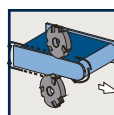
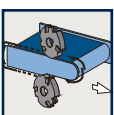



Multifunctional trimming unit MF 60 Servotrim

For processing the edging overhang at the upper and lower edge of the workpiece as well as for corner rounding of the front and rear edge. Servo-controlled movement with soft-touch function for optimal handling of e.g. high gloss surfaces or light weight panels. Workpiece thickness up to 60 mm. With EDGETEQ S-380 profiLine.

Automation to suit every need

Adjustment to two different radii and automatic adjustment of the tracing rollers.

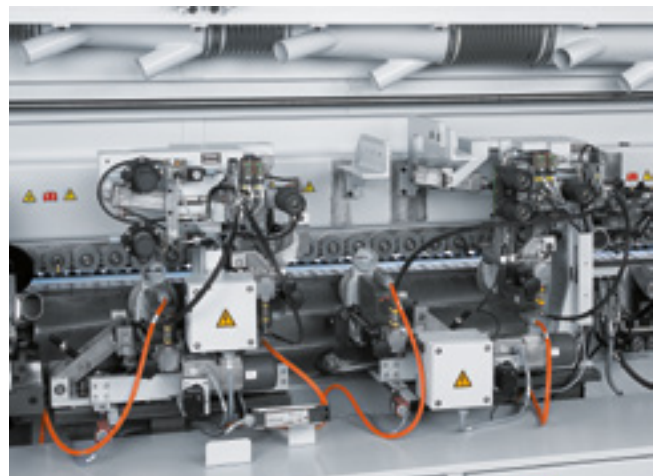
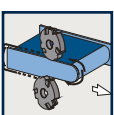

Profile trimming unit FF12

For corner rounding of thick PVC edges, as well as postforming and softforming profiles at feed speeds of up to 20 m/min. Equipped with servo motor adjustment for different edge thicknesses. Workpiece thickness up to 60 mm. With EDGETEQ S-380 profiLine.

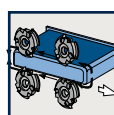

Profile trimming units for EDGETEQ S-500 profiLine

The profile trimming units are universal. As a user, your job is to program any profile that takes your fancy: Then stand back and watch the extreme speed and precision of the expert execution. The efficient mode of operation results in higher

productivity. Our profile trimming units permit both corner rounding and trimming of upper and lower projecting edges.

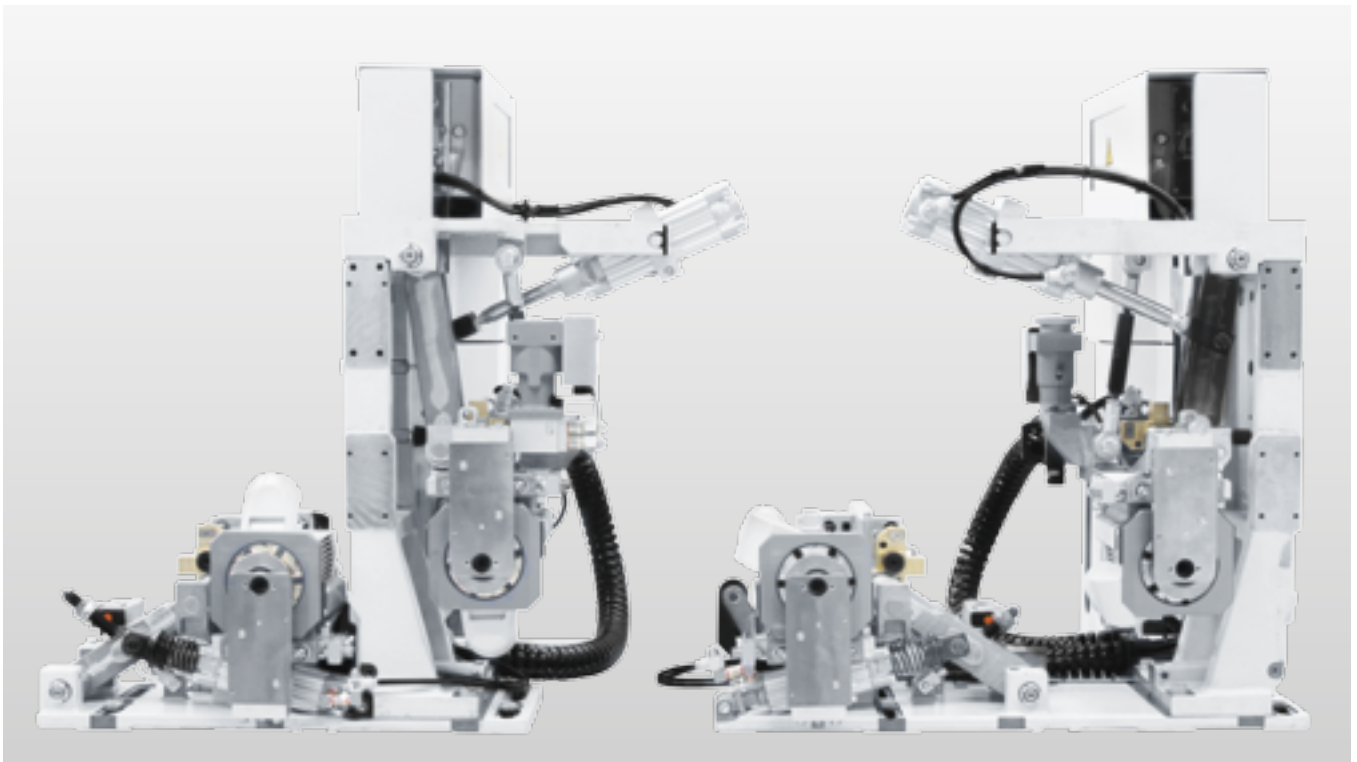

Profile trimming unit FF30

For rounding edges at the leading and trailing workpiece edge top and bottom at a constant feed speed.

With EDGETEQ S-500 profiLine.

Automation to suit every need

Chamfer/radius adjustment (2-point-adjustment) for rapid changes between processing operations, e. g. from 0.4 mm to 2 mm edge.

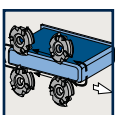

Profile trimming unit FF32

For rounding edges at the leading and trailing workpiece edge top and bottom at different feed speeds. By dividing the cut over four motors, each corner can be processed in synchronous rotation.

This lends corners a perfect trimmed finish for every edging type – even with veneer. Workpiece thicknesses and feed speeds are automatically adjusted without manual intervention.

With EDGETEQ S-500 profiLine.

Automation to suit every need

Stepless chamfer/radius adjustment for rapid changes between processing operations, e.g. from 0.4 mm to 2 mm edge.

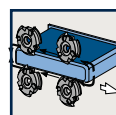

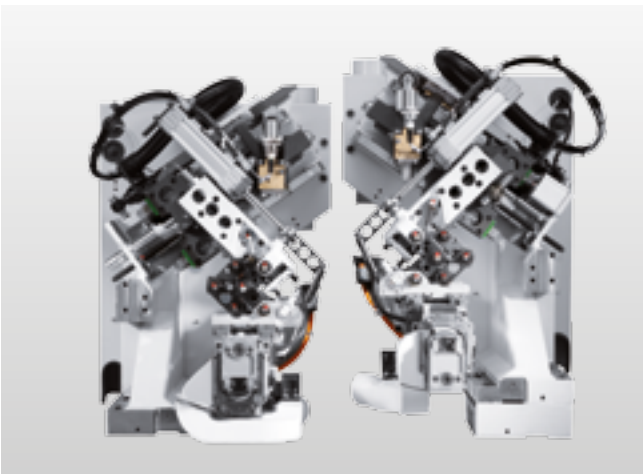
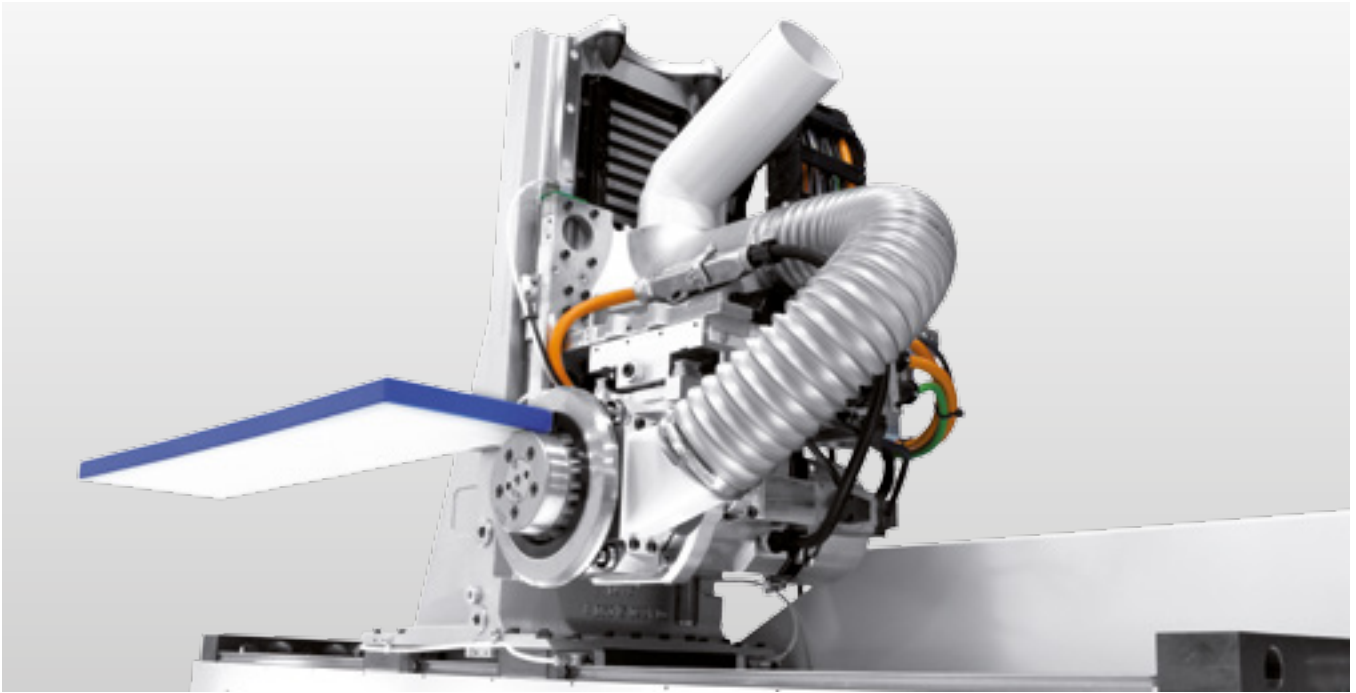

Profile trimming unit FK11

For trimming around the leading and trailing edge and for processing overhanging edges on top and bottom.
With EDGETEQ S-500 profilLine.

Automation to suit every need

Stepless chamfer/radius adjustment for rapid changes between processing operations, e.g. from 0.4 mm to 2 mm edge.

Profile trimming unit FK30 and FK31

For trimming around the leading and trailing edge.
With EDGETEQ S-500 profilLine.

Automation to suit every need

- Adjustment to three different radii and chamfer
- Automatic adjustment of the tracing roller diameter
- Automatically adapted tracing force
- Automatically adapted speed

FK 31: steplessly adjustable tracing force

E.g. for honeycomb boards and soft materials

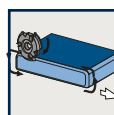
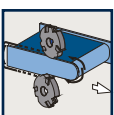

Grooving and sanding in a single pass

The EDGETEQ S-500 profiLine offers the ideal units for efficient production of your workpieces in a single pass without additional process stages. A grooving unit, belt

sanding unit and chamfer/radius sanding unit are available to choose from for your own individual configuration.

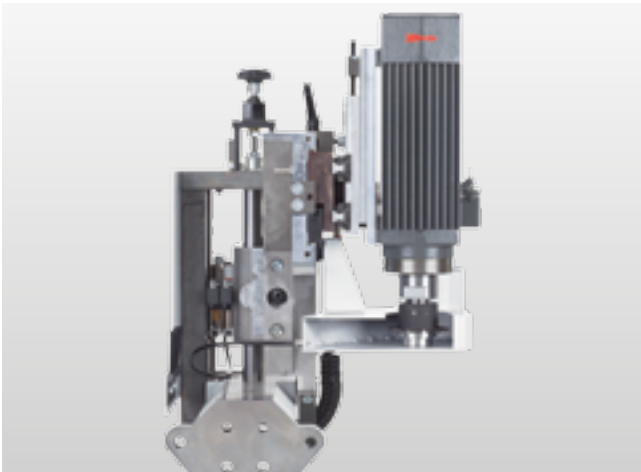

Tiltable grooving unit

For grooving work pieces either from the bottom side or from the edge side. It is possible to do either continuous grooving or non continuous grooving, as well as jump grooving for biscuit joints. With EDGETEQ S-380 profiLine.

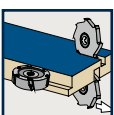

Universal trimming unit

Universal unit with high capacity for grooving and profiling work. Flexible by unlimited setting options. With EDGETEQ S-380 profiLine.

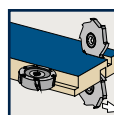

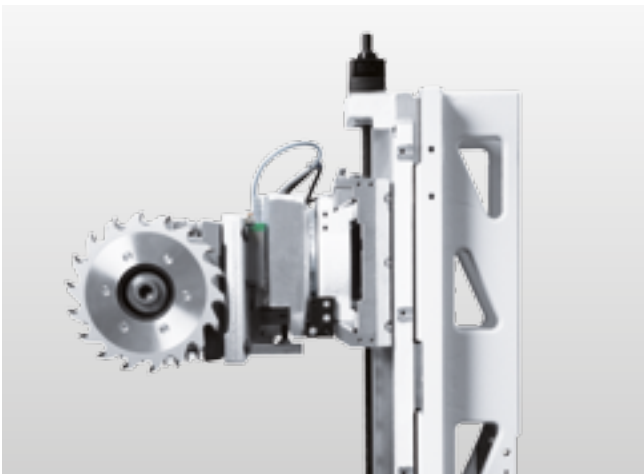

Grooving unit SF21

For grooving, rebate trimming and profiling.
With EDGETEQ S-500 profiLine.



Belt sanding unit KS10

For sanding straight veneered and solid edges including oscillation
as a standard feature.
With EDGETEQ S-500 profiLine.

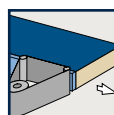
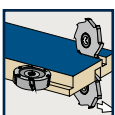

Finishing units

The quality of your products is increased by the use of perfectly coordinated finishing units. With ideally coordinated

finishing units, HOMAG adds a perfect, high-quality final touch to your products.

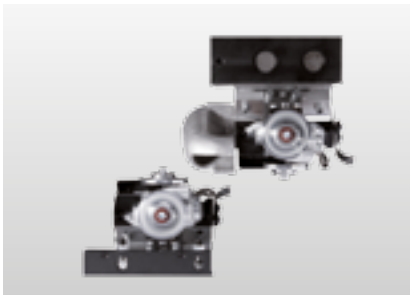

Profile scraper PN10

For smoothing trimmed edges to achieve an optimum appearance.

With all HOMAG profiLine series.



Glue joint scraper

For the perfect finish.

With EDGETEQ S-380 profiLine.

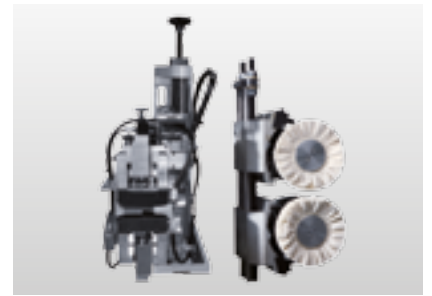

Finish processing

Comprising a glue joint scraper for disposal of glue residues at the top and bottom of plastic edges and a buffing unit.

With EDGETEQ S-500 profiLine.

Automation to suit every need

Travel out of the work area.

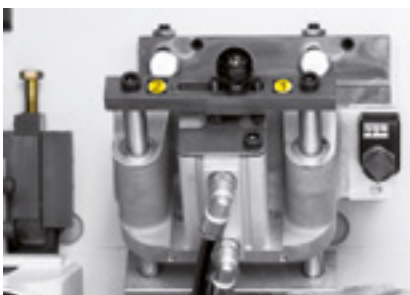

Automation to suit every need

Automatic move-in / move-out from the work area via pneumatic adjustment.

With EDGETEQ S-500 profiLine.



Buffing unit

To polish edges and maintain their natural color.

With EDGETEQ S-380 profiLine.

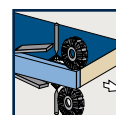
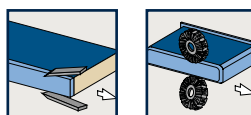
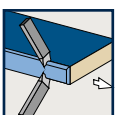

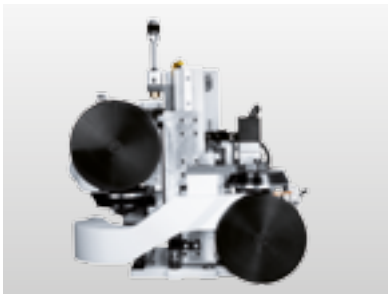

Multi scraper MN21

For smoothing trimmed edges to achieve an optimum appearance. Optimum resetting for different profiles, corrections to a pinpoint standard of accuracy. Reproducible quality to the highest standard.

With EDGETEQ S-500 profiLine.

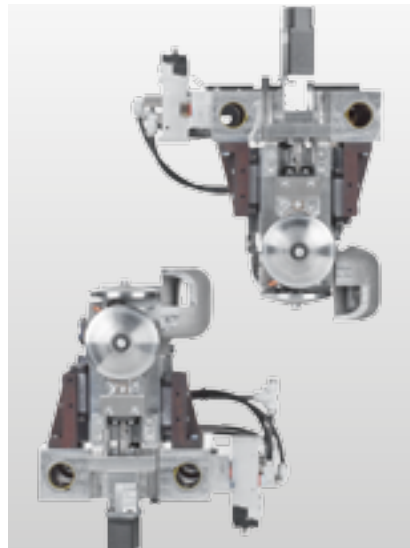

Multi-stage scraper unit MZ40

Fully automatic adjustment between 2 different profiles by means of servo motors with a stepless adjustment. With EDGETEQ S-380 profiLine.

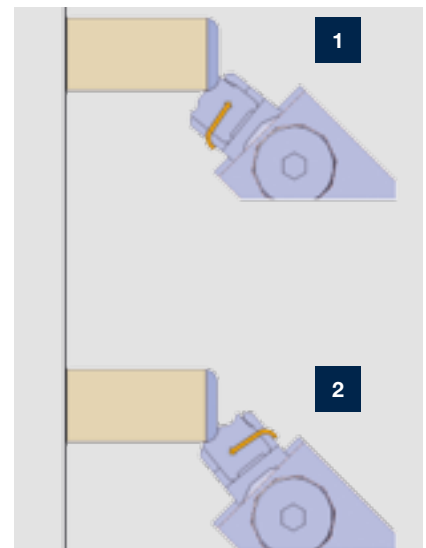

1 Profile 1

2 Profile 2

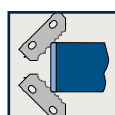

Additional professional solutions

For the HOMAG profilLine series, we offer ideal supplementary equipment options to upgrade the existing equipment outfit for your specific needs. For instance, simplify handling using a sliding carriage or the scissor-

design workpiece support. With a wide edging variety, the machine can be upgraded with a larger edging magazine, PUR pre-melt unit or pre-melt unit for two colors.



Suction cup for strip separation

Separation of strips from a package.



6-slot magazine

Automatic infeed of six different edges.



Pre-melting unit for two colors

Two alternating glue colors can be melted on conveniently without the need to empty the storage tank.



QA glue tank front section for exchanging

For fast exchange between different types of hot melt glue.
Glue tank front section to be exchanged for PUR application
Teflon coated.



Variable tracing roller diameter

Permits automatic adjustment of the tracing roller diameter to different applications.



Rolling side tracing unit for FK11/FF30/FF32

Processing of sensitive workpieces.

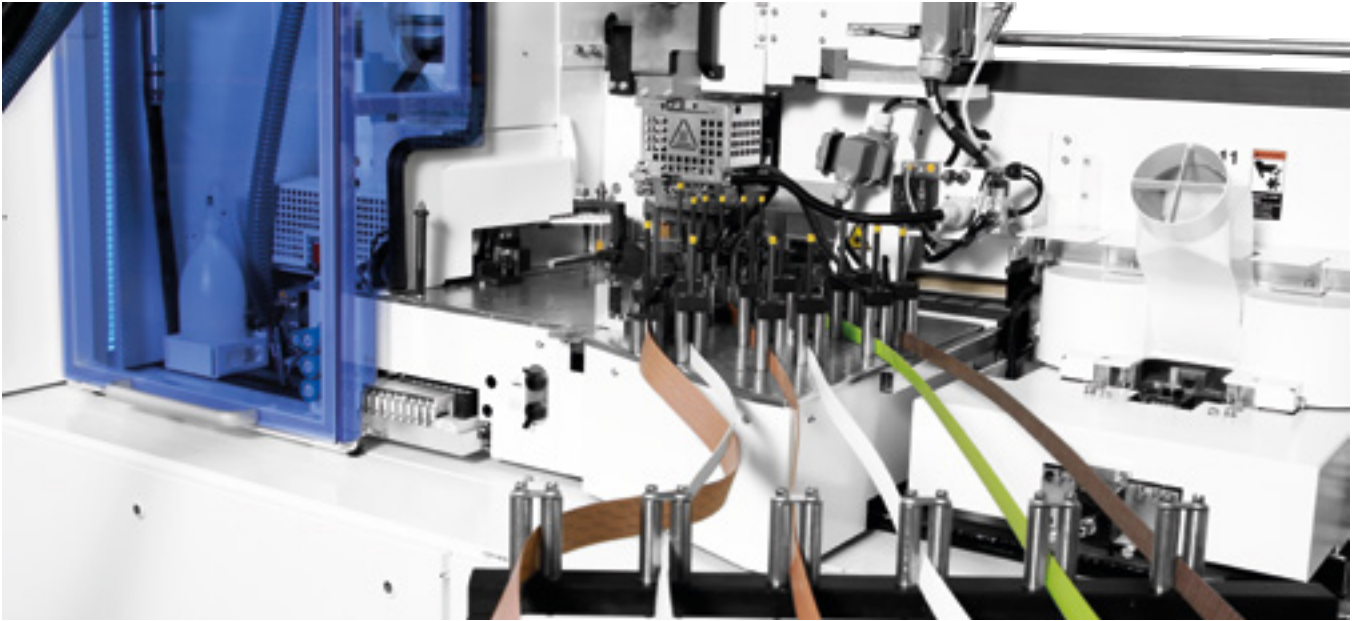

Tracing elements nesting



Automatic glue joint scraper adjustment

On foil thickness for workpieces with and without protective foil.

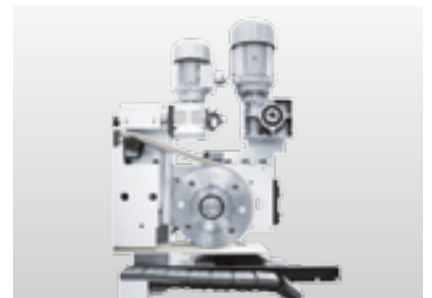

Top pressure (driven by motor)

For clamping and gentle-action transport of workpieces with sensitive surfaces.



Remote control

This allows the feed system to be started while the operator is standing by the unit during setting work.



Increased cooling output > 40° C

To protect the electronic system at ambient temperatures of over 40° C. Ensures reliable, trouble-free production even in extreme climate conditions.



Tight roller distance

Optimal workpiece guidance in the area e. g. of the profile trimming unit for workpiece length < 240 mm.



Control with powerTouch

Using the widescreen format multitouch monitor, you control machine functions by direct touch contact. The ergonomically optimized design and an array of help and assistant functions substantially simplify operation.



Standardized

Standardized operating elements, software modules and standardized design characterize the powerTouch control system for HOMAG machines. This allows different HOMAG machines to be controlled in the same way.



Ergonomic

Intuitive, direct control via the touch-sensitive touchscreen monitor.



Evolutionary

Design and function united in one control system. The futuristic powerTouch machine control system is combined with state-of-the-art operating concepts used in smartphones and tablet PCs.

powerTouch – the innovative control system: Easy, standardized, ergonomic and evolutionary

HOMAG machines are designed to make easy operation and reliable control a matter of course. Our innovative touchscreen operating philosophy combines design and function in a single control system. The full HD multitouch

monitor, ergonomic touch operation, simple navigation and the standardized user interface all enhance processing efficiency.

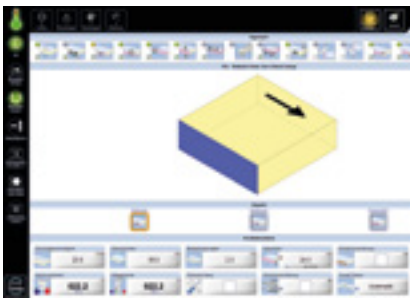

Programming with woodCommander

User-friendly programming system using graphically supported input screens.



Support via TeleServiceNet Soft

High-speed servicing and assistance through targeted troubleshooting and support over the Internet.



Evaluation with MMR Basic

The software evaluates the productivity of your machine and supplies usage-dependent maintenance notifications.

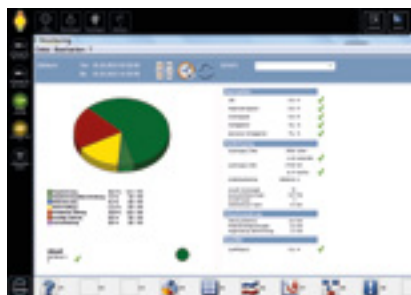

MMR Professional (option)

The MMR Basic upgrade additionally evaluates shifts, analyzes error messages and permits a link to be created to the data evaluation center in the office.



Diagnosesystem woodScout (option)

Alongside error messages in plain text, woodScout also provides a graphic representation of the error location. In addition to the system's expert knowledge database, users can store their own troubleshooting solutions.

Workpiece infeed systems and return conveyors

HOMAG workpiece infeed systems guide your workpieces automatically and precisely towards the edge processing machine. In this way, you will create the basis for a high standard of processing quality and efficient processing operations. LOOPTEQ return conveyors provide the ideal

complement to the machines of the HOMAG profiLine series. We offer you solutions that are perfectly coordinated in terms of size, performance and speed – whether batch size 1, just in time or series production. The hardware and software speak the same language.



Workpiece infeed system WZ10

For workpieces which have already been cut to a high level of angular and parallel accuracy with their unfinished fixed measurement, we recommend using workpiece infeed WZ10. This is configured specifically for transporting pre-sized workpieces for flexible production.



Workpiece infeed system EZ14

A parallel precisely angled cut is not necessary with this workpiece infeed system. The workpieces are fed at a precise angle in the longitudinal and transverse direction.

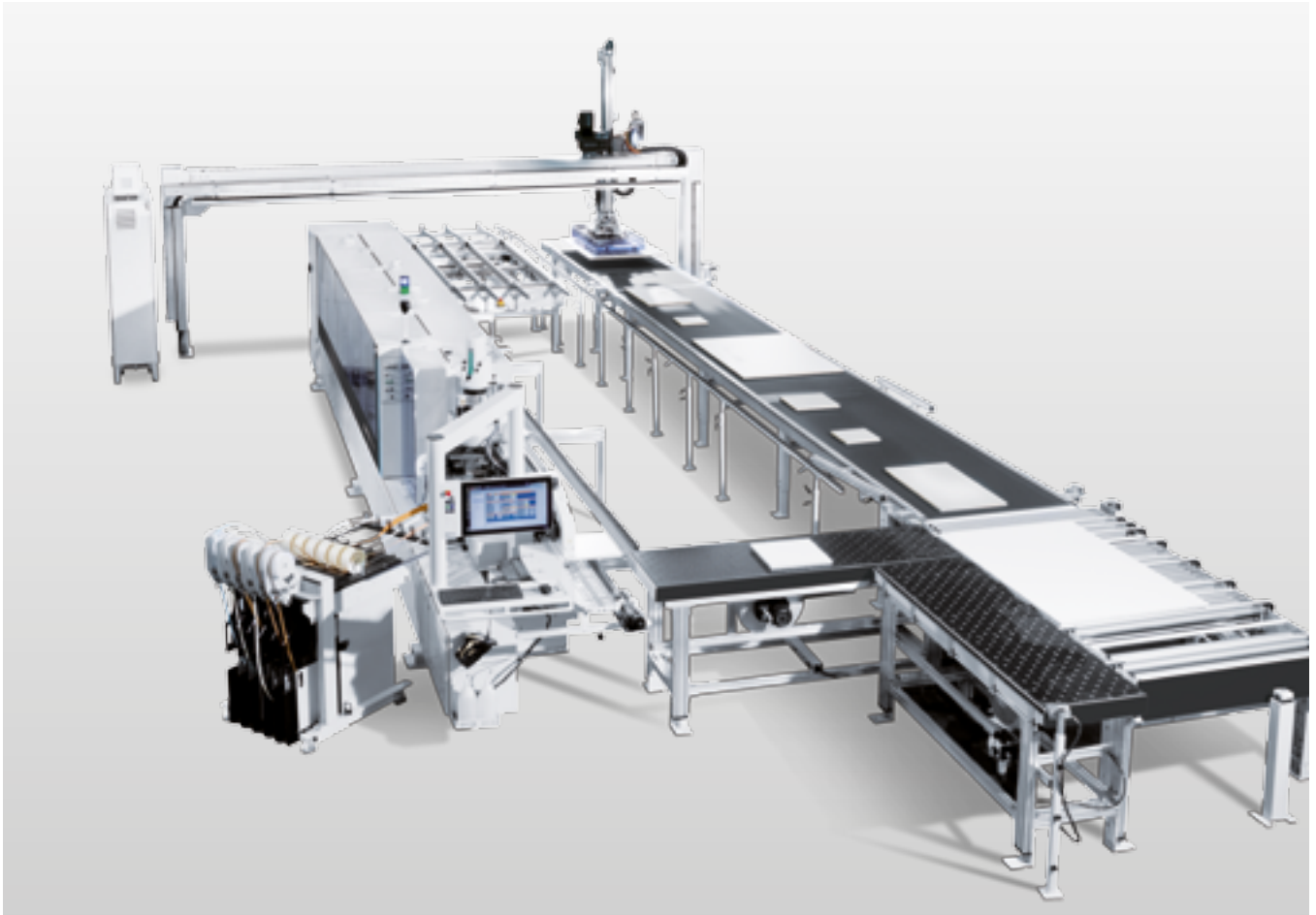

Integrated workpiece handling with LOOPTEQ O-600 Edition

The high automation degree makes the return conveyor LOOPTEQ O-600 Edition with workpiece handling a real multi-talent. Finished workpieces can be fed out or stacked.

- Interlinked material flow with high output
- Defined panel turning for process oriented workpiece return
- Gentle workpiece handling with vacuum traverse
- Economic single person operation
- Operator will be released from heavy physical work



LOOPTEQ O-300

For wide part diversity – from small and lightweight through to large and heavy workpieces.

- Fast amortization – pays off from 15 hours working time per week
- Low quality costs – gentle workpiece handling with air cushion table
- No training required – simply set up, connect and BOOMERANG® is ready to go
- Flexible operator organization – thanks to economic one-man operation
- Ergonomic operation – operator will be released from heavy physical work

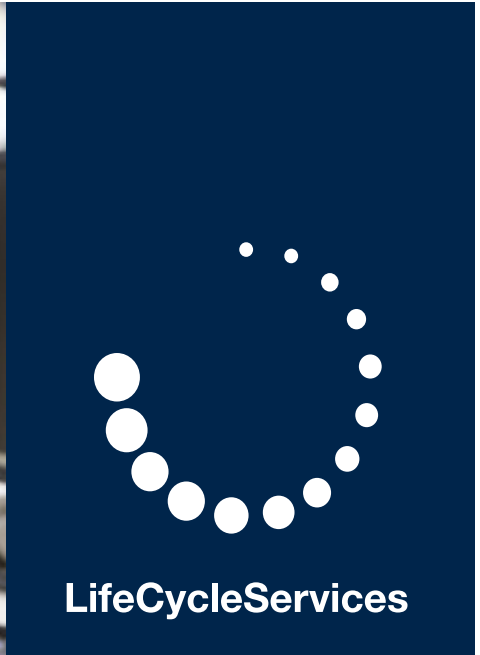

HOMAG Life Cycle Services

The sale of our machines comes with all-in optimum service backup and individual advice. We support you with service innovations and products which are especially tailored to your requirements. With short response times and fast

customer solutions we guarantee consistently high availability and economical production – over the entire life cycle of your machine.



Remote Service

- Hotline Support by remote service for control systems, mechanics and process technology, resulting in 85.2 % fewer on-site servicing callouts
- Mobile applications such as ServiceBoard reduce the costs through fast help in case of troubles by mobile live video diagnosis, online service message and the online spare parts shop eParts



Spare Part Service

- Identify, request and order spare parts around the clock via www.eParts.de
- Local availability of parts offered by our sales and service companies as well as sales and service partners all over the world
- Reduction of downtimes through defined spare parts and wear parts kits



Modernization

- Keep your machinery up to date and increase your productivity and product quality to prepare yourself today for the product requirements of tomorrow
- We support you with upgrades, modernization as well as individual consultancy and developments



HOMAG Finance
 – precisely the right financing

- We offer you tailored financing proposals for your machinery or plants. Our financial advice goes hand in hand with our expertise relating to technical questions. Your personal contact partner will take care of the entire process
- The benefit for you: The ability to invest without delay in new technologies and remain financially flexible

1,200
 service employees around the world

>90%
 less on-site-services through successful remote diagnosis

5,000
 customer training sessions per / year

>150,000
 machines electronically documented in 28 languages in eParts



Trainings

- Training tailored precisely to your requirements ensures the optimum operation and maintenance of your HOMAG machinery by your own machine operators
- The trainings also include customer specific training documents with practice-proven exercises

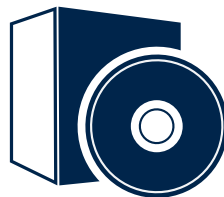

Software

- Telephone support and consultancy through software support
- Digitalization of your samples by means of 3D scanners saves time and money compared to new programming
- Subsequent networking of your machinery with intelligent software solutions ranging from construction to production



Field Service

- Increased machine availability and product quality by certified service staff
- Regular checks through maintenance / inspection guarantee the highest quality of your products
- We offer you the highest availability of technicians in order to reduce downtimes in case of unpredictable troubles

Technical data of HOMAG profiLine series

The HOMAG profiLine series provides a diverse product range for precisely positioned edge banding in optimum HOMAG quality. The machines are available in different machine lengths which can be integrated into any machine

environment. By equipping the machine individually with a choice of different units, it can be used for wide-ranging different production assignments.

TECHNICAL DATA HOMAG PROFILINE SERIES

MACHINE DIMENSIONS	EDGETEQ S-380	EDGETEQ S-500
Overall length (mm)	4,770 – 7,760	6,365 – 13,365
Working height (mm)	950	950
WORKING DIMENSIONS		
Workpiece width (mm)		
with workpiece thickness 22 mm	70	min. 55
with workpiece thickness 60 mm	150	min. 100
Workpiece thickness (mm)	8 – 60	12 – 60
Edge thickness, coils (mm)	0.4 – 3	0.3 – 3
Edge thickness strips / solid strips (mm)	0.4 – 12	0.3 – max. 20
MISCELLANEOUS		
Vorschub regelbar (m/min)	8 – 18	16 – 20 (25, 30)
Pneumatic system (bar)	6	6
Electrics	for public power supply all over the world	

EDGETEQ S-380 profiLine

TYPE	1630	1640	1650	1660	1670	1680	1690	1691
Overall length (mm)	4,770	5,270	5,760	6,260	6,760	7,260	7,760	8,260

EDGETEQ S-500 profiLine

TYPE	5	6	7	8	9	10	11	12
Overall length (mm)	6,365	7,365	8,365	9,365	10,365	11,365	12,365	13,365

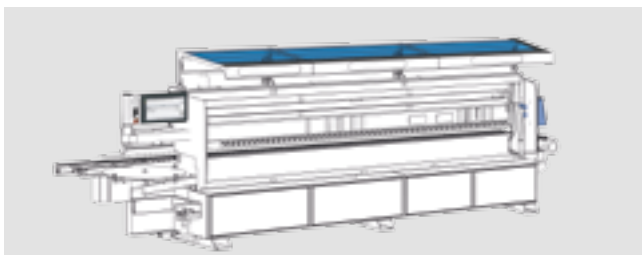

EDGETEQ S-380 profiLine

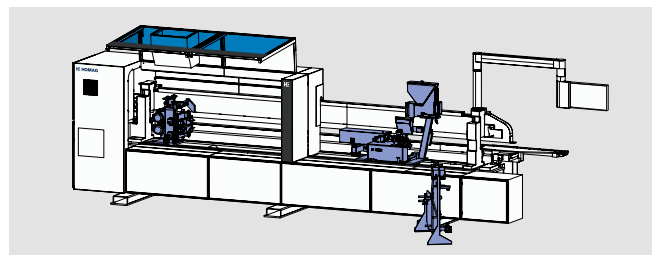

EDGETEQ S-500 profiLine



HOMAG Group AG

info@homag.com
www.homag.com



YOUR SOLUTION