

# Concentrating on what matters.

**HOMAG**

**Our panel dividing saws**  
SAWTEQ B-400

**YOUR SOLUTION**

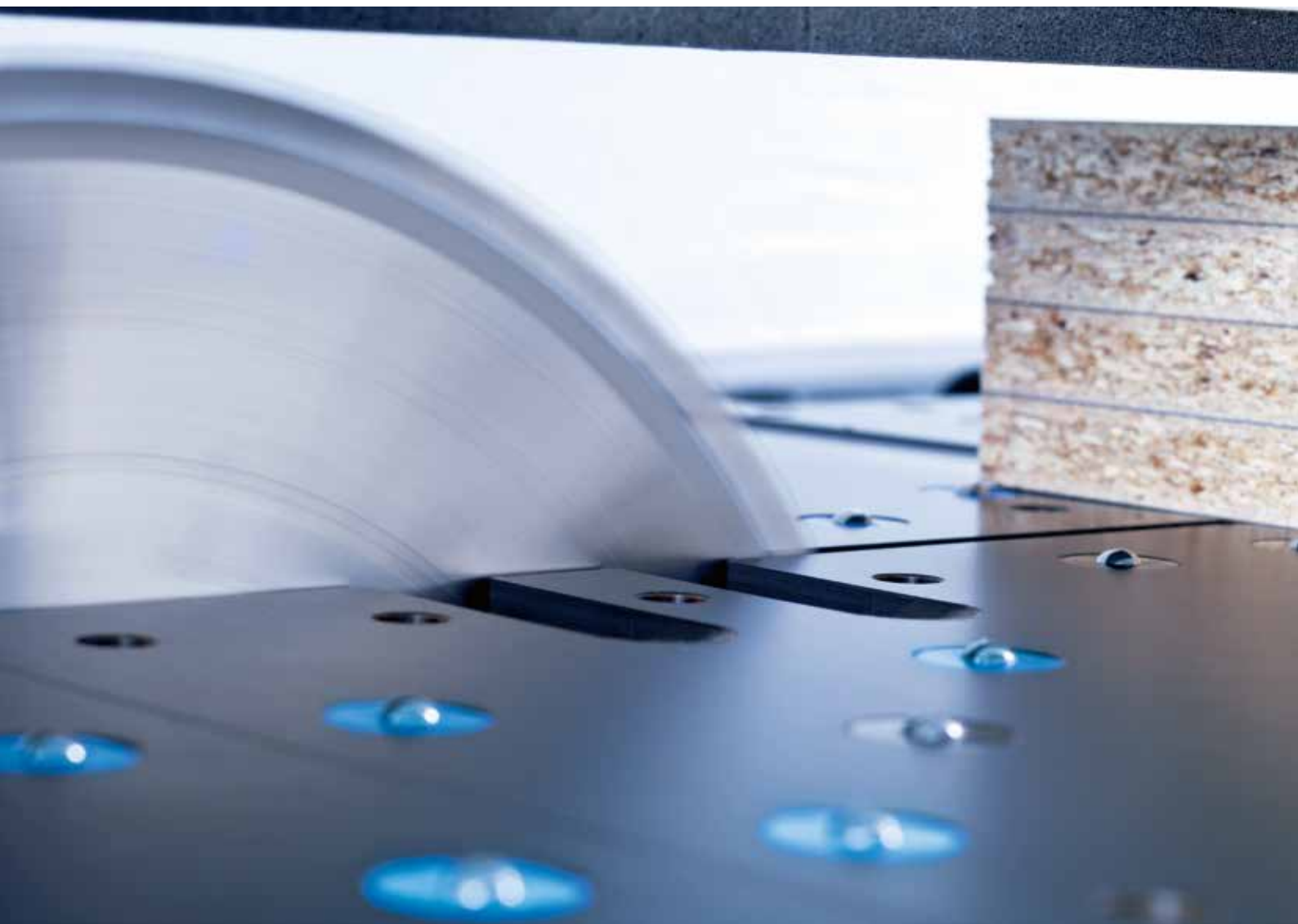



## SAWTEQ B-400 – strong and versatile

In terms of cutting, are you looking for reliable quality, strong performance, and high material throughput? If so, the SAWTEQ B-400 saws are the perfect choice for you. Their high saw blade projection and the necessary flexibility for cutting books or individual panels alone guarantee this. Added to this is the high degree of customization that is possible thanks to numerous optional features. This means you can configure a saw exactly to your requirements.

### YOUR SOLUTION

### MORE AT HOMAG.COM



SAWTEQ B-400

### CONTENTS

- 04 Software
- 16 SAWTEQ B-400
- 18 SAWTEQ B-400 with lifting table
- 20 SAWTEQ B-400 as angular saw unit
- 22 Standard features
- 32 Optional features
- 59 Technical data
- 60 Service

## What's different? The software!

It efficiently integrates the machine into the production process. This results in seamless, intelligently networked processes from start to finish. In short: the right software unlocks new value-added potential. That is what makes it so important.





## CADmatic 5 – intuitive to operate and open for digital networking

CADmatic 5 is the state-of-the-art, high-performance saw control system from HOMAG. It provides a vast range of functions and great ease of use thanks to its intuitive operating concept and clear administrative functions. What's more, CADmatic 5 is open for communication with other machines and software solutions.

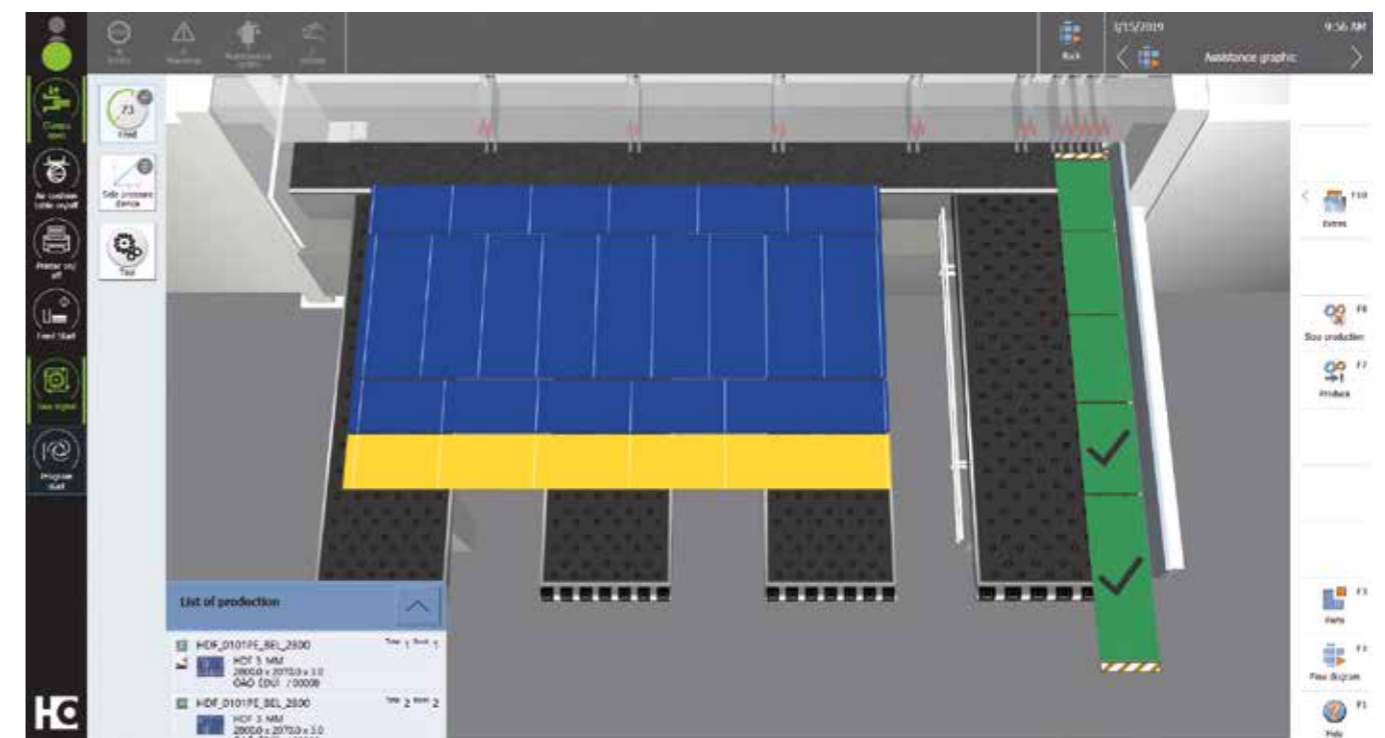

### CADmatic 5 – the change in perspective

The latest generation of the HOMAG saw controller features a new assistance graphic that clearly shows the machine operator what he has to do next. Compared to the previous process graphic that showed all the work steps of the saw (and can still be called up if required), this new graphic represents a 180-degree change in perspective!

#### Highlights:

- The new 3D assistance graphic supports the operator and is intuitive to operate, which shortens the training period and reduces errors to a minimum
- This results in efficient processes and a steady output
- Simple handling via tapping and swiping (touch functions)
- Quick change between the individual sections

- Graphically supported diagnostics
- powerTouch user interface
- Ready for connection to tapio
- 21" full-HD widescreen monitor with multi-touch display

**Find out more in the "CADmatic" brochure.**

## powerTouch der nächsten Generation: **powerTouch2**

Schneller, komfortabler, übersichtlicher: Nutzen Sie die Vorteile unserer weiterentwickelten Touch-Bedienoberfläche powerTouch. Wir haben unser einheitliches Bedienkonzept weiter optimiert und den Anforderungen unserer Kunden angepasst. Steuern Sie Ihre HOMAG Maschinen jetzt noch schneller und intuitiver. Das neue, moderne Design ist klar und übersichtlich. Die innovative Touch-Bedienung ist so konzipiert, dass Sie ganz einfach und komfortabel zum gewünschten Ergebnis gelangen.



Unsere erfolgreiche powerTouch Philosophie – **einfach, einheitlich, ergonomisch, evolutionär** – konsequent weiterentwickelt



### **Noch übersichtlicher**

Wir haben die powerTouch2 Bildfläche noch klarer strukturiert. Sie sehen nur die für Sie relevanten Informationen. Alles Wesentliche auf einen Blick – und trotzdem entgeht Ihnen kein Detail. Und das alles in einem frischen, ansprechenden Design.



### **Noch schneller**

Mit der neuen powerTouch Generation nehmen Sie noch schneller Eingaben an Ihrer Maschine vor. Im Vergleich zur bisherigen Version sparen Sie bis zu 30 % Zeit ein. Möglich machen dies neue Features wie eine automatische Wort-Vervollständigung, eine Popup-Tastatur, die durchgehend geöffnet bleiben kann, und Windows-ähnliche Funktionen wie das Auswählen gängiger Aktionen direkt über den Start-Button.



### **Noch komfortabler**

Auch den Ampel-Dialog und das Startmenü haben wir nochmals verbessert. Durch längeres Drücken der Programm-Icons werden mögliche Aktionen nicht nur angezeigt, sondern können direkt aufgerufen und aktiviert werden. Die Bedienung ist somit unmittelbar und Sie verlieren keine Zeit durch das Öffnen von Anwendungen. Zudem können für die Applikationen auch Vorschabilder und Zusatzinformationen statt einfacher Programm-Icons angezeigt werden. Dies führt ebenfalls zu mehr Transparenz und vermeidet unnötige Navigation in Applikationen hinein.



### **Noch intuitiver**

Die Maschinenbedienung ist kinderleicht. Viele Funktionen ähneln denen eines Smartphones bzw. eines Tablets und sind dadurch bereits vertraut. Selbst Einsteiger finden sich auf Anhieb zurecht und können die Maschine innerhalb kurzer Zeit bequem steuern.

## Optional features: increasing productivity with the appropriate cutting optimization software

Production time, material yield, parts handling and logistical process: efficient panel cutting with seamless processes requires intelligently optimized cutting patterns. For HOMAG saws, you can get the appropriate optimization solution on demand – from large to small, as permanently installed software or directly from the tapio cloud. You have the choice because the SAWTEQ B-400 is now tapio-ready.



### intelliDivide – the easy way to first-class optimization results

Simply upload the parts list. Done! The result? A choice of several alternatives for cutting patterns and entire runs. That's how easy intelliDivide makes it.

In detail: the cloud-based optimization software intelliDivide utilizes significantly higher computing capacities than does locally installed optimization software and can therefore swiftly provide the user with multiple variants of an optimization result.

This means the operator can choose from a variety of options, including a result based purely on reducing waste, a result based on the shortest machine time or on the simplest handling, perfectly adapted to the relevant requirements.

Applications are varied and are geared towards both the trade and industry. Would you, for example, occasionally like to optimize cutting patterns without having to buy, install and maintain a software solution? Then intelliDivide is just what you need. This is because you can use intelliDivide quite simply on an on-demand basis, as software as a service.

However, intelliDivide is also very interesting for large companies. Why so? Via the cloud, you can optimize your cutting patterns extremely quickly, intelligently and accurately with the help of a powerful calculation engine.

The SAWTEQ B-400 is tapio-ready, allowing intelliDivide to recognize the machine configuration of your saw and take it into consideration for every optimization run in the cloud, completely automatically. This pays off every time in the case of high material throughput.



### Cut Rite cutting optimization software

Efficiency through planning: this short phrase sums up the key benefits of the Cut Rite software. With this world-leading software solution, you can optimize waste and systematically lower the overall costs for cutting.

- Optimized project control
- Efficient cutting processes
- Full control of costs
- Faster calculations

**Find out more in the “Cut Rite” brochure.**

### CADplan

As an alternative to the comprehensive Cut Rite optimization software, CADplan, an add-on module for CADmatic, can also be used to perform small optimization jobs directly at the saw.

# Optional feature: IntelliGuide – innovative smart operator guidance

IntelliGuide is the first assistance system in the history of panel dividing technology to enable saws to respond to the actions of the machine operator in an intelligent and flexible manner. The assistance system becomes more intelligent with each stage of expansion: from IntelliGuide basic, to advanced, right through to professional. So you get exactly your solution.



### The foundation:

#### 1. CADmatic 5

IntelliGuide is the result of a long period of technical evolution. It all started with the CADmatic saw control system – software that has since become indispensable. The new version of the software, CADmatic 5, is now more focused on the user than ever before. This is thanks to a new assistance graphic in CADmatic 5 that clearly shows the operator the next step they have to perform. Compared to the previous process graphic that showed all the work steps of the saw (and can still be called up if required), this new graphic represents a 180-degree change in perspective!

### MORE AT HOMAG.COM



IntelliGuide

### General benefits of IntelliGuide

- Intuitive machine operation
- Systematic means of avoiding errors
- Fast processes: operator and saw work in tandem and do not slow each other other down
- The operator rarely needs to look at the monitor and so can concentrate on processing the cutting pattern
- Fluid, ergonomic processes for efficient and concentrated work
- Smooth change of operator possible at any time

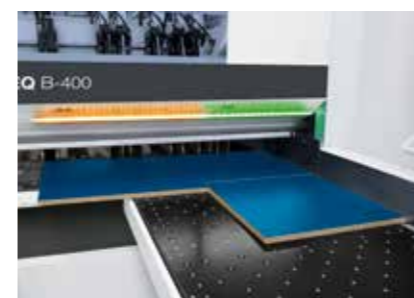

### IntelliGuide basic:

#### 1. CADmatic 5

#### 2. LED strip at the cutting line

- Colored LED signals at the cutting line allow intuitive operation and a speedy and safe way of working
- Using the colored LED elements, machine operators can immediately see if a part has been fully processed, needs to be cut again or can be disposed of as waste
- Based on the LEDs that are lit up, the operator can determine whether the workpiece being processed meets the required specifications



### IntelliGuide advanced:

#### 1. CADmatic 5

#### 2. LED strip at the cutting line

#### 3. Camera

- The system uses this camera to see which strip or part the operator has deposited and how it has been aligned
- If the intended part is not deposited, IntelliGuide responds to the change of plan in a flexible manner
- If the change does not necessitate further action, the saw starts working after brief confirmation. Otherwise, IntelliGuide provides the operator with feedback and instructions

#### 4. Illumination

- Enhances safety and quality by ensuring the workplace and workpieces are evenly lit
- Improves the appearance of the workplace and makes it even more ergonomic

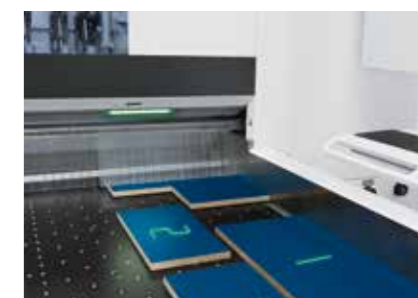

### IntelliGuide professional:

#### 1. CADmatic 5

#### 2. LED strip at the cutting line

#### 3. Camera

#### 4. Illumination

#### 5. Laser

- Projects clear information regarding processing and handling directly onto the current workpiece
- Arrows, for example, indicate the direction in which a panel needs to be turned and how it needs to be positioned. An X means that the wrong part has been inserted. The trash can symbol indicates waste parts
- In short: thanks to the self-explanatory symbols, operators always know which step they need to perform next and can immediately take the appropriate action

## Destacking concept: for zero errors – even with mixed stacks

The destacking concept guides the operator from depositing the first part to forming the perfect stacked pallet. This has been achieved by combining software and hardware in an overall concept. The software tells the machine operator when and where he should stack each particular part. You select the appropriate hardware according to your requirements. Altogether, this adds up to improved efficiency and ergonomics for all work steps. Times and routes that do not add value are systematically reduced.

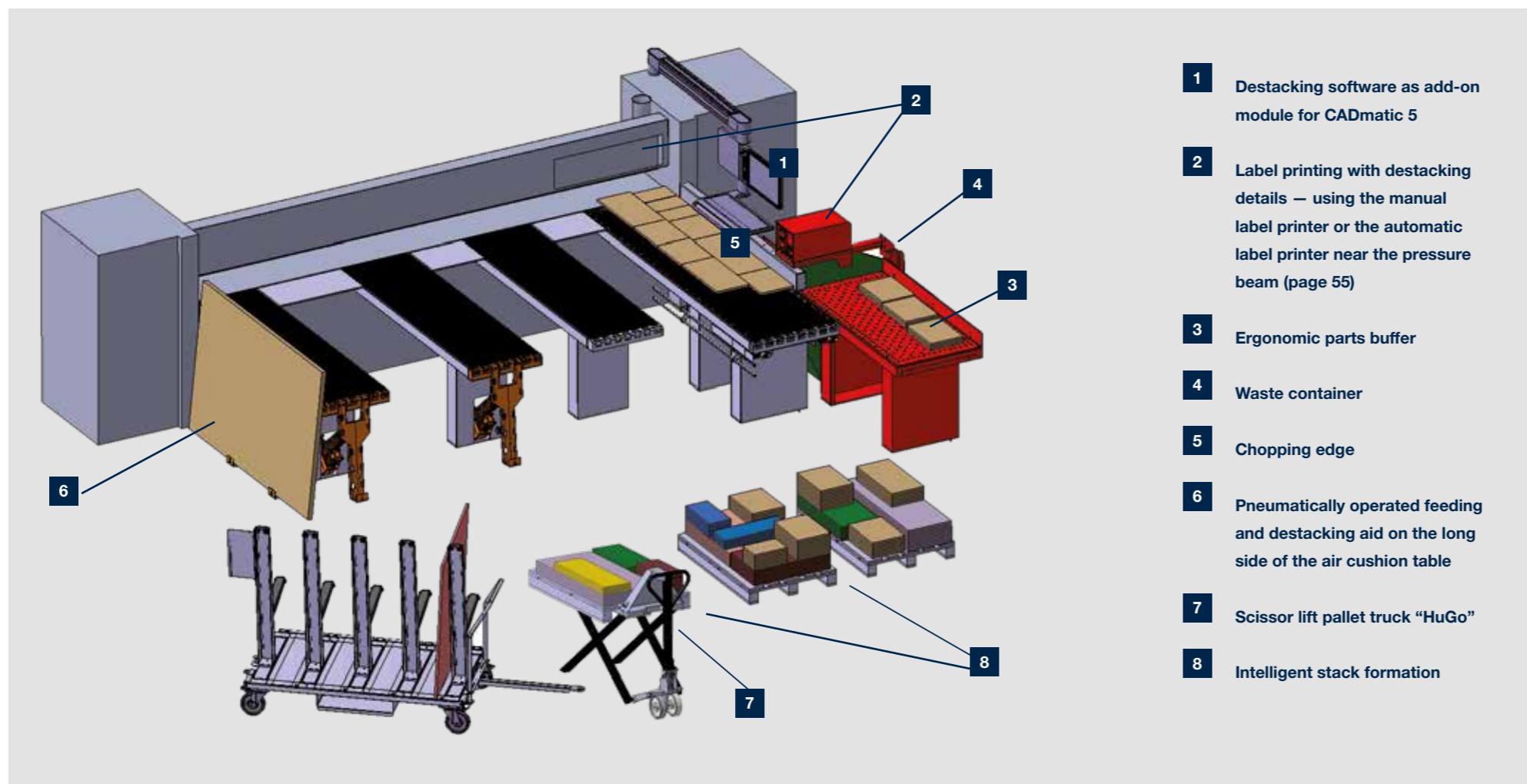

- 1** Destacking software as add-on module for CADmatic 5
- 2** Label printing with destacking details – using the manual label printer or the automatic label printer near the pressure beam (page 55)
- 3** Ergonomic parts buffer
- 4** Waste container
- 5** Chopping edge
- 6** Pneumatically operated feeding and destacking aid on the long side of the air cushion table
- 7** Scissor lift pallet truck “HuGo”
- 8** Intelligent stack formation

**Benefits**

- The operator is guided and always knows where he needs to stack each particular part
- Saves space, as demonstrably fewer pallets are required
- Intelligent stack formation according to individual specifications
- Reduces the walking required
- No more time wasted looking for the right destacking location
- Lowers the error rate considerably

**MORE AT HOMAG.COM**

Destacking concept



### CADmatic destacking module

Which part goes where? The CADmatic destacking module answers this question by means of an integrated destacking graphic. This option is available in the versions lite and practive. In both versions, the individual parts are color-coded in the cutting pattern and also in the assistance graphic. This means the operator can see on the monitor exactly when he must place a particular part on a particular pallet.

Additional advantages of the practive destacking module: not only does the operator see which part he needs to stack on which pallet, he also sees the exact position on the pallet where he is to place the part.

This ensures intelligent, stable stack formation. Furthermore, the practive destacking module allows the program sequence and the destacking strategy to be controlled more finely and appropriately. You can specify, for example, whether the stack formation is optimized for subsequent processing steps on the basis of the order or the material. These priorities can be combined with one another and weighted according to the primary objective.

This results in clear, highly efficient operator guidance with less walking between the saw and the destacking location, optimized pallet utilization and process-optimized, stable stack formation.



### Scissor lift pallet truck “HuGo”

The scissor lift pallet truck “HuGo” is equipped with automatic height control and facilitates ergonomic and smart destacking processes. A light barrier controls the automatic raising and lowering of the pallet truck, also allowing you to remove all the parts from the pallet at an ideal working height – at an edge banding machine, for example.



### MORE AT HOMAG.COM

Pallet truck “HuGo”

### Parts buffer with swiveling label printer

The parts buffer with swiveling label printer increases the efficiency of processes and optimizes handling.

- The parts buffer indicates to the operator by LED display whether a part should be temporarily stored. This is particularly useful for forming stable stacks or to avoid slowing down the saw, for example. The process of temporarily storing parts is itself very ergonomic.
- The swiveling label printer is located in a convenient position for the operator and dispenses the right label for each part at the right time.

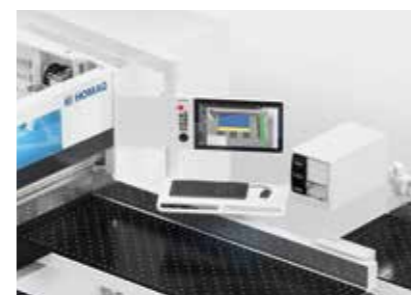

Illustrations may show the technical principle but not the precise machine variant described. Further optional features, for example, may be shown.



## SAWTEQ B-400

With the SAWTEQ B-400 you get a compact and powerful single saw that offers impressive versatility. It is ideal for connecting to an automatic HOMAG horizontal storage system, for example.



### The highlights

- 110 mm saw blade projection, 125 mm as an option
- Ergonomic table height of 920 mm
- Easy to handle
- Reliable and powerful



## SAWTEQ B-400 with lifting table

This model sets you up for big jobs. The integrated lifting table for automatic feeding speeds up your production processes by a considerable margin, particularly if you frequently cut panels made from the same material or in books.



### The highlights

- Feed either from the back via the lifting table or manually from the front for single panels
- High material throughput for cutting books and series
- 110 mm saw blade projection, 125 mm as an option
- Ergonomic table height of 920 mm



## SAWTEQ B-400 as angular saw unit

As an angular saw unit, the SAWTEQ B-400 is designed for maximum precision in continuous operation. The unit copes smoothly with large numbers of panels in an industrial scenario, cutting entire books of panels as accurately as it does single panels. Fully automatically and with long-term reliability.

### The highlights

- Compact yet powerful angular saw unit
- Ideal for single panels and small books
- High quality cuts in record time
- 110 mm saw blade projection, 125 mm as an option
- Machine tables equipped with air jets as standard feature



A craftsman with grey hair, wearing a blue short-sleeved shirt and a light-colored apron, is working on a wooden table in a workshop. He is leaning over the table, using a tool to work on the edge. A red and white object, possibly a sanding block or a small tool, is resting on the table surface. The background shows other wooden furniture pieces, including chairs, in the workshop.

## Standard features

Even in the standard version, the SAWTEQ B-400 offers the full range of technical features and can be put to flexible use, either as standalone machine, interlinked with other machines or as part of a production line, depending on the production concept. This makes the SAWTEQ B-400 the ideal solution for the trade and industry in many applications.

**Good to know:**

- Equipped with the latest CADmatic 5 control software
- Extremely energy efficient thanks to intelligent ecoPlus technologies
- Low maintenance, ergonomic and intuitive operation



## ecoPlus – because efficiency starts with the use of resources

Energy, time, material and personnel are all precious resources. Conserving them increases productivity and saves costs. The ecoPlus technologies from HOMAG help you to achieve this aim, providing countless innovations that save energy and reduce your operating costs. What's more, ecoPlus reduces CO<sub>2</sub> emissions and protects the environment. A worthwhile investment twice over.

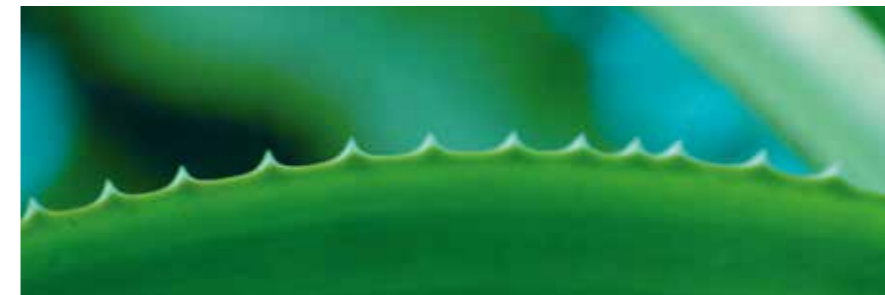

### ecoPlus technologies for maximum energy savings

- The standby button, a standard feature, puts the saw in an energy-saving standby mode at the touch of a button
- SAWTEQ B-400 with IE3 motors
- Variable speed control by means of a modern bypass circuit for all models with frequency-controlled main saw motor
- The geometry of the saw carriage enables highly efficient dust extraction
- All models are equipped with an energy monitor to monitor consumption
- Less energy required thanks to optimized dust extraction
- Thin-kerf saw blades can be used on request, ensuring less waste among other benefits
- Many innovations for improved ergonomics and smooth production processes

### WITH ECOPLUS, YOU SAVE:

up to **20%** of energy\*

\* Compared to our older saws

## High performance is the result of numerous high-tech solutions

Speed, quality and precision during the cutting process can only be achieved if panel materials are moved quickly, gently and with a high level of accuracy. This is ensured by numerous technologies that interact smoothly with one another – from the program fence and pressure beam to the clamps and patented side pressure device.



### Program fence for precision and dimensional accuracy

- Resistant to torsion and bending
- Electronically controlled
- Precision guidance on H-girder
- Electromagnetic measuring system guarantees a positioning accuracy of +/- 0.1 mm per meter
- Measuring system involves no wear and no maintenance

### Rugged pressure beam for first-class cut quality

- Large-area pressure zone directly at the cutting line reduces material vibrations to a minimum
- Linear guide on both sides
- Rack and pinion ensure the necessary parallel adjustment
- The result is accurate cuts, for books too
- With height control on request (available as an option)



### Clamps

- Robust clamps, all with two fingers
- Gentle positioning of material
- The bottom fingers of the clamps can be removed at any time to allow the clamp base to be cut in perfect alignment – a fast means of adjustment
- The clamping pressure can be adjusted (manually) to suit each particular material
- The short, rugged design allows material to be precisely held and guided more gently
- Irrespective of the book height, the top fingers of the clamps do not exert any leverage; instead, they are lowered horizontally and their entire contact surface rests on the material. This increases the working depth and ensures material is held firmly
- Designed for continuous, multi-shift operation



### Patented: central side pressure device

- Integrated directly in the saw carriage, which shortens cycle times by up to 25% in comparison with conventional systems
- Infinitely variable adjustment of contact pressure – depending on panel thickness. This allows even thin panels, laminates or sensitive materials to be processed perfectly. Another key feature here is the book-height-dependent control of the contact pressure: the higher the book, the greater the pressure



### Chopping edge on the right-angled fence

With the help of the chopping edge, waste strips can be disposed of quickly and easily. The robust edge is within easy reach of the operator and ideally positioned on the right-angled fence, allowing waste to fall directly into the container for improved ergonomics.

### MORE AT HOMAG.COM



Central side pressure device



Chopping edge

## The saw carriage: high performance, low consumption

Exceptionally smooth running, high precision and low energy consumption are the hallmarks of the saw carriage developed especially for the SAWTEQ B-400.



### One saw carriage, numerous benefits

- Torsion-resistant, rugged and resilient basic design of the steel plate body for maximum dynamics and precision
- Infinitely variable feed speed – for precision cutting of demanding materials
- Long-term accuracy of saw blade projection
- Fast, precise, low-wear and infinitely variable positioning of the main saw blade by means of linear guide system with rocker arm (patent)
- Energy saving feature: main saw motor is not raised
- Low-noise, maintenance-free main saw blade drive
- Spring-pressured running wheels (optional) always in perfect contact with the guides
- Light sensor with blower unit (available as an option)
- The design of the saw carriage ensures excellent dust extraction results
- Postforming package, optional (page 48)



### Power-Loc system

Making it quick and easy to change the saw blade.

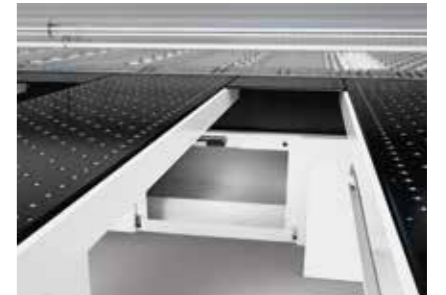

### Handy cleaning flap

Quick and convenient: the area under the saw carriage is easily accessible via flaps, allowing easy removal or vacuuming of cutting waste.

**MORE AT HOMAG.COM**



Power-Loc



Cleaning flaps

## More technology from the start – for saws with lifting table and angular saw units

Panel dividing saws with integrated lifting table and angular saw units set themselves apart with their automatic feeding system and increased level of automation. In short, these saws work differently from the standard SAWTEQ B-400 and therefore require additional technical solutions even in their standard version.



### Powerful feeding system

- Panels are fed to lifting-table saws and angular saw units via an electro-hydraulic four-column lifting table
- Automatic determination of book height
- Equipped as standard with longitudinal profiles and sensing device
- Also suitable for thin materials from 9.5 mm upwards. Suitable for materials from 3 mm upwards if equipped with the optional micro-feed and hold-back device (page 38)
- Maintenance-free and no lubrication required

### Separate backing wall

The backing wall is not attached to the machine bed, ensuring precise cuts. This is because vibrations caused by the movement of stacks on the lifting table are not transferred to the machine bed.

Illustrations may show the technical principle but not the precise machine variant described. Further optional features, for example, may be shown.



### Outfeed device for the rip saw (for angular saw units only)

The outfeed device pushes the panel material onto the intermediate table and the trim onto the waste flap.

### Intermediate table for transferring to the cross-cut saw (for angular saw units only)

- Special motor-driven pushers ensure perfect cross transfer in a quick process
- Roller rails can be raised and lowered
- Lengthwise and crosswise alignment after transfer
- AB-BA system for mirror-image cutting
- Integrated headcut device



### Waste flap (for angular saw units only)

- The waste flap opens fully automatically when required and removes cutting waste from the rip saw
- Opens and closes in perfect coordination with the operating cycle of the system



## Optional features

More technology for customized production down to the very last detail: these features allow you to supplement the functionality of your saw in line with your requirements – from adding a link to a storage system and performing the actual cutting process to labeling and destacking. So you get exactly the solution you need.



## Feeding solutions ranging from S to XXL

Manually transporting panel material from the shelf to the saw is time-consuming and often not ergonomic. This is just one of the reasons why automation solutions from HOMAG pay off within a short time. Furthermore, they save a lot of space and are available for almost every size of company. The spectrum of solutions ranges from basic feeding via the lifting table to large-scale storage connection.



### Large-scale storage connection

HOMAG offers a range of high-performance solutions for large businesses and customers with strict automation requirements. In addition, all SAWTEQ B-400 saws are open for connection to virtually all storage systems, ensuring the very highest level of performance.

**Find out more in the “Handling solutions for cutting applications” brochure.**



### Low-cost storage system integration

Not everyone who wants to work rationally and efficiently has to opt for the large-scale solution. HOMAG also offers storage control connections for small, up-and-coming trade businesses. These connections can be used to noticeably speed up your processes and save you money twice over.

- Small footprint
- Attractive price
- Movable in x and y directions
- Saw and storage system compatible with each other
- Perfect handling – even with just one machine operator
- Easy, ergonomic operation
- “Storage system controlling the saw” possible. With this system, the production sequence can be changed by the storage system if making the change will speed up the production process as a whole

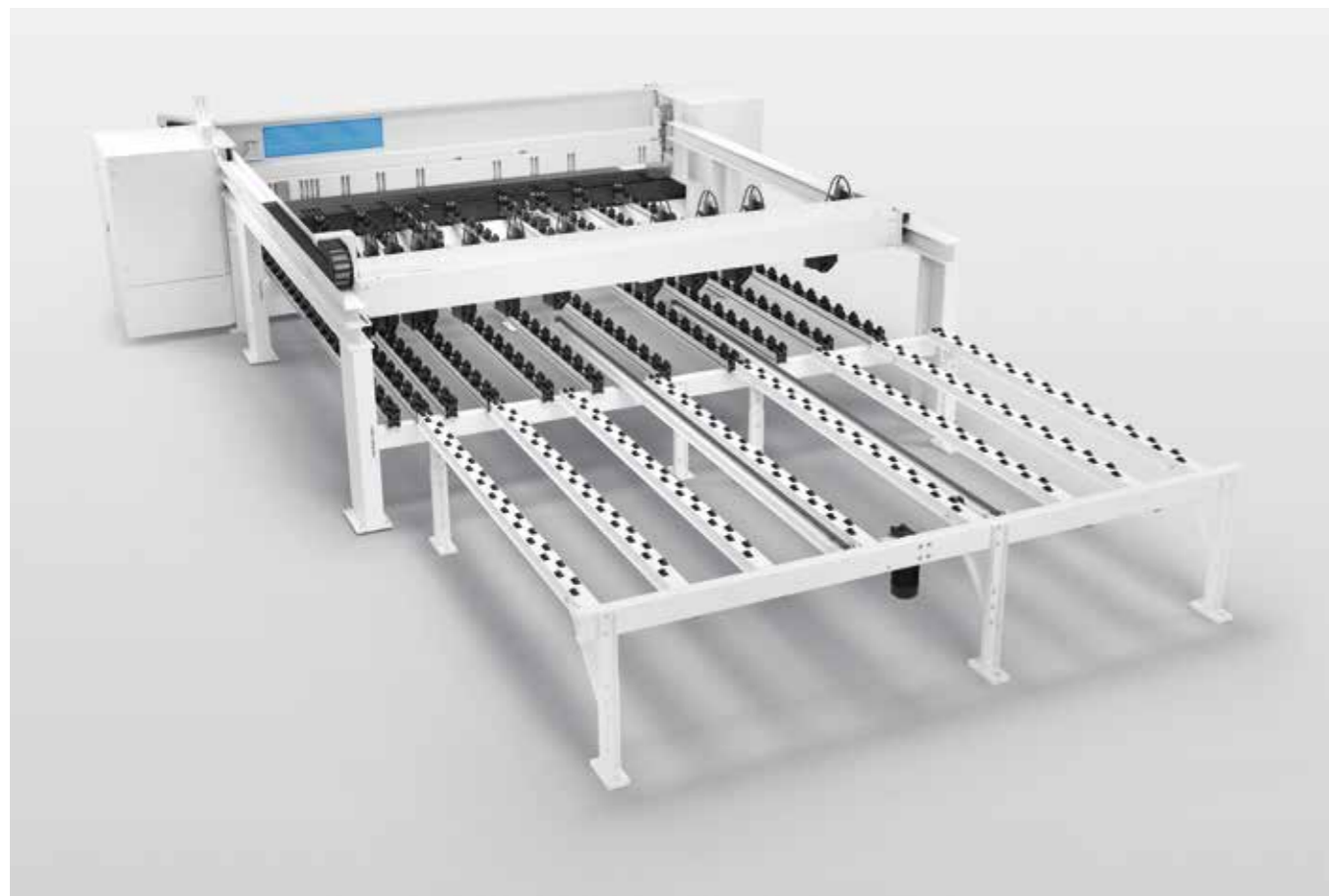

#### Feed-stacking table with integrated feed

When linked to a simple storage system, the saw has to stop working briefly when a new panel is fed. The feed-stacking table now ensures smooth, faster cycles: while one panel is still being cut, the storage system already positions the next panel(s) on the feed-stacking table with integrated feed.

- Ideal in combination with the HOMAG panel labeling system (page 55)
- Can be retrofitted
- Plug & Play: easy add-on
- Without alignment
- Perfectly matched to the saw (height, width, roller rails)
- Virtually no more idle time



#### Greater visibility while maintaining safety (for single saws without lifting table only)

While angular saw units and saws with lifting table come standard with an all-round protective fence, saws without lifting table have a protective guard around the rear machine table. The sides of this protective guard are made up of individual elements which can be equipped with windows if desired – one is already included as standard. Further windows can be added as needed. This ensures greater visibility while maintaining safety levels.

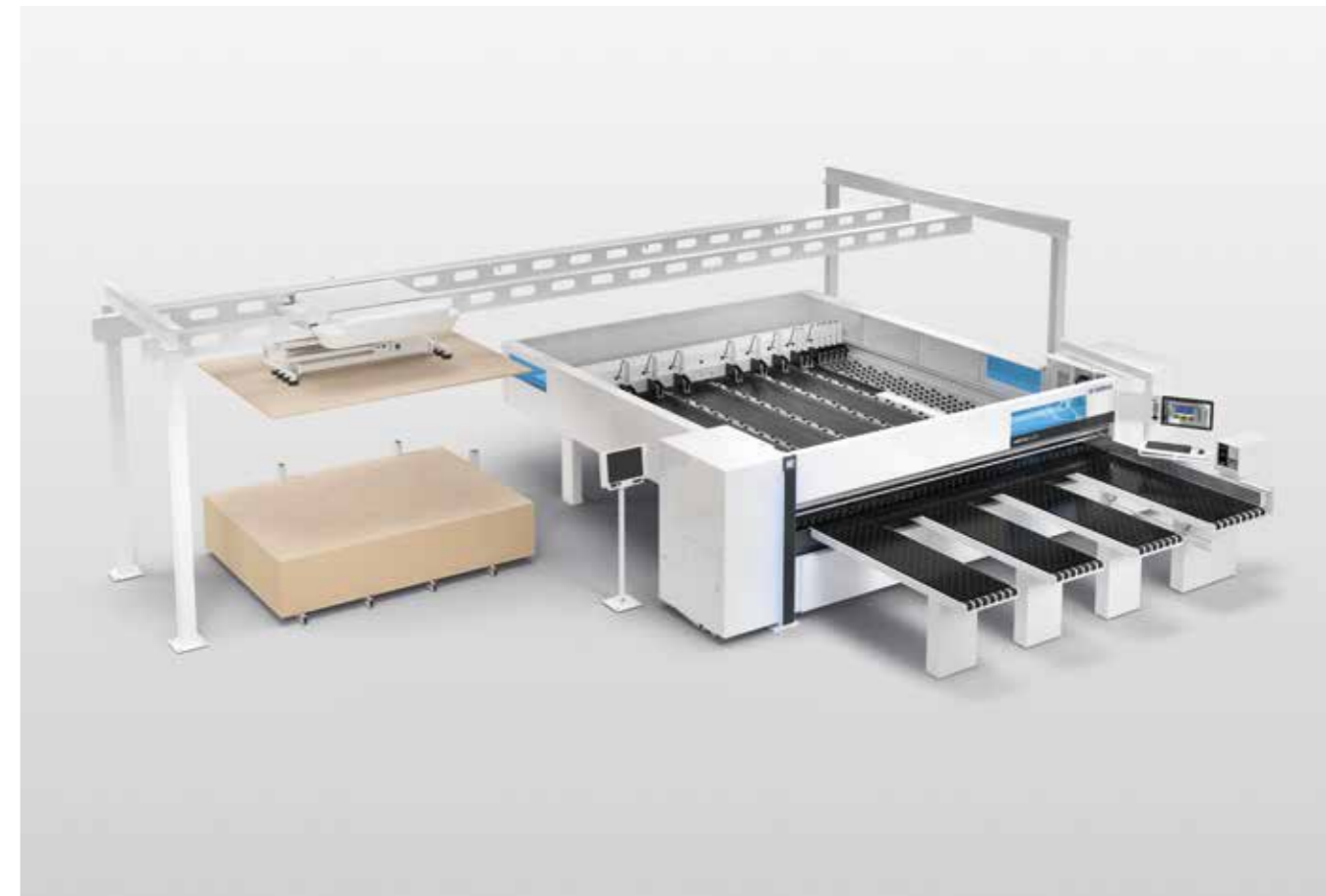

#### Gantry vacuum feeding system HBX 150 (for single saws without lifting table only)

Automation in the smallest of spaces is the promise made by the HBX 150 gantry vacuum feeding system. It fetches the next panel required from the stacking station adjacent to or behind the saw, turns it if needed, and then places it in the saw. With maximum care of material and fully automatically during the saw cycle.

The highlights:

- A choice of various layouts, to suit specific requirements and available space
- With traveling lifting device and suction traverse
- Turning device for up to 90 degree rotation
- With automatic weight determination
- For especially ergonomic handling
- Manufactured by Barbaric

## Extra tools for demanding materials

Exceptional materials require exceptional technical solutions. These are available in abundance for the SAWTEQ B-400 – for thin panels, for example.

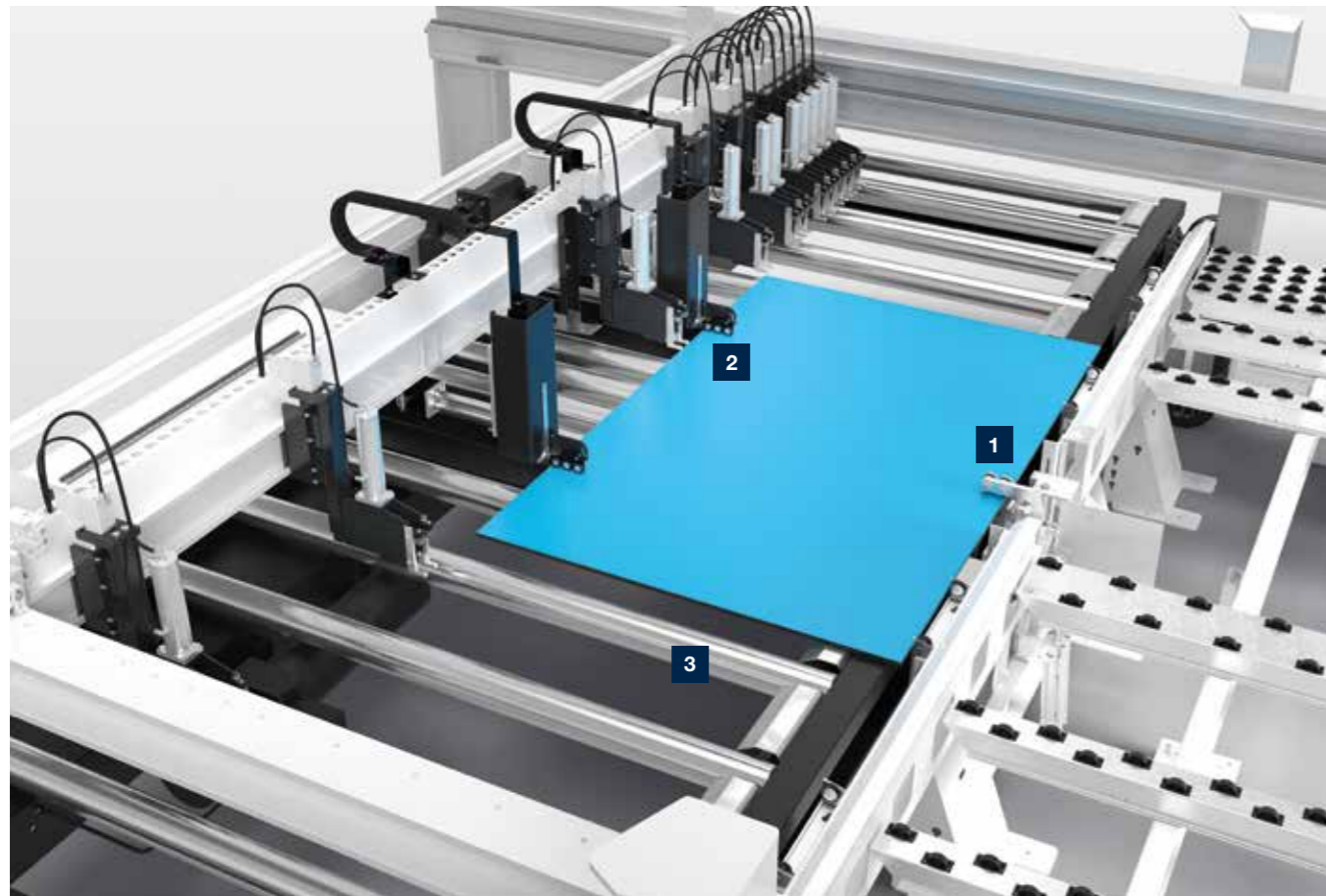

**1 Hold-back device for thin panels (for lifting-table saws and angular saw units only)**

For thin panels from a thickness of 3 mm.

**2 Micro-feed for thin panels (for lifting-table saws and angular saw units only)**

The micro-feed option allows thin panels from 6 mm upwards to be pushed onto the rear machine table (provided that their properties meet HOMAG specifications). Book height is measured by a non-contact, electromagnetic measuring system which is completely maintenance-free.

**3 Extra impetus for feeding (for lifting-table saws and angular saw units only)**

The automatically driven roller conveyor integrated in the lifting table and additional roller conveyors on the side ensure fast stack changeover.

**MORE AT HOMAG.COM**



Micro-feed

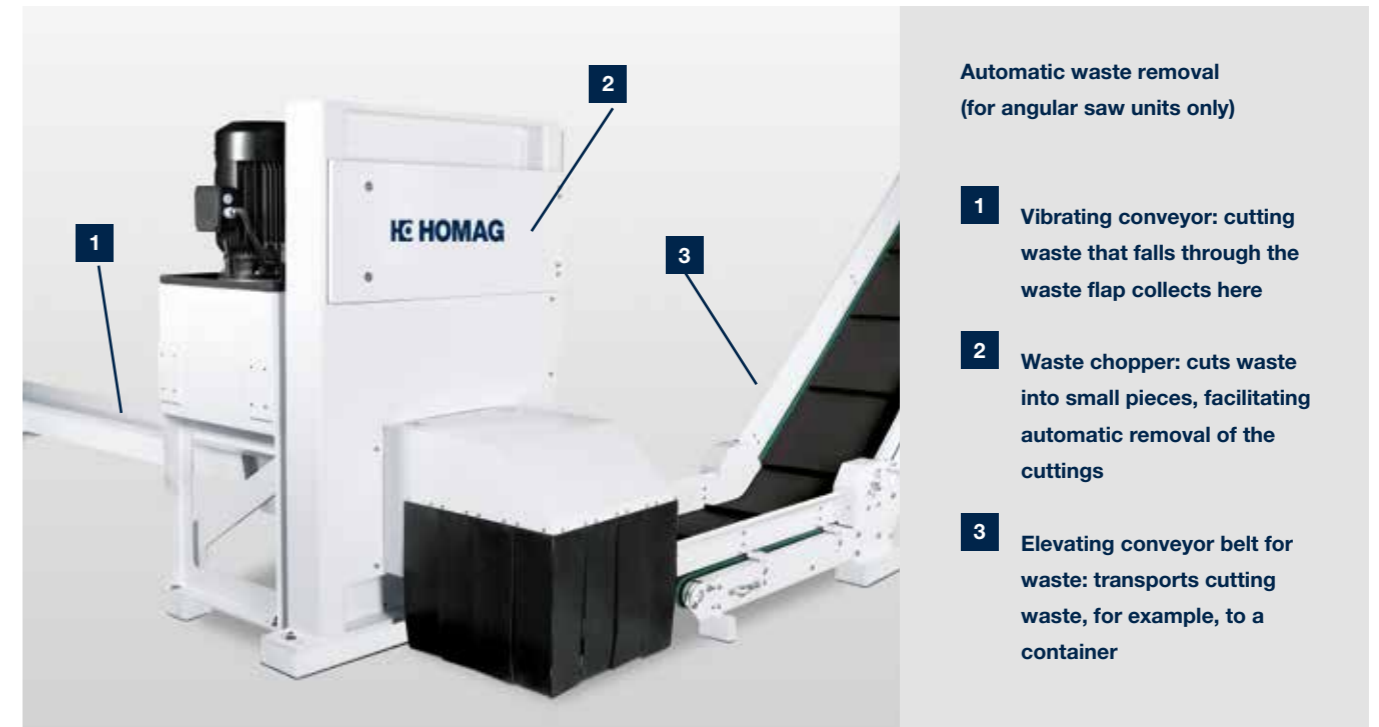

**Automatic waste removal (for angular saw units only)**

**1 Vibrating conveyor: cutting waste that falls through the waste flap collects here**

**2 Waste chopper: cuts waste into small pieces, facilitating automatic removal of the cuttings**

**3 Elevating conveyor belt for waste: transports cutting waste, for example, to a container**

## Small detail, big impact

It is often the smallest details that make the difference. After all, when these details come together, they can have a noticeable impact on the speed and ease of the production process.

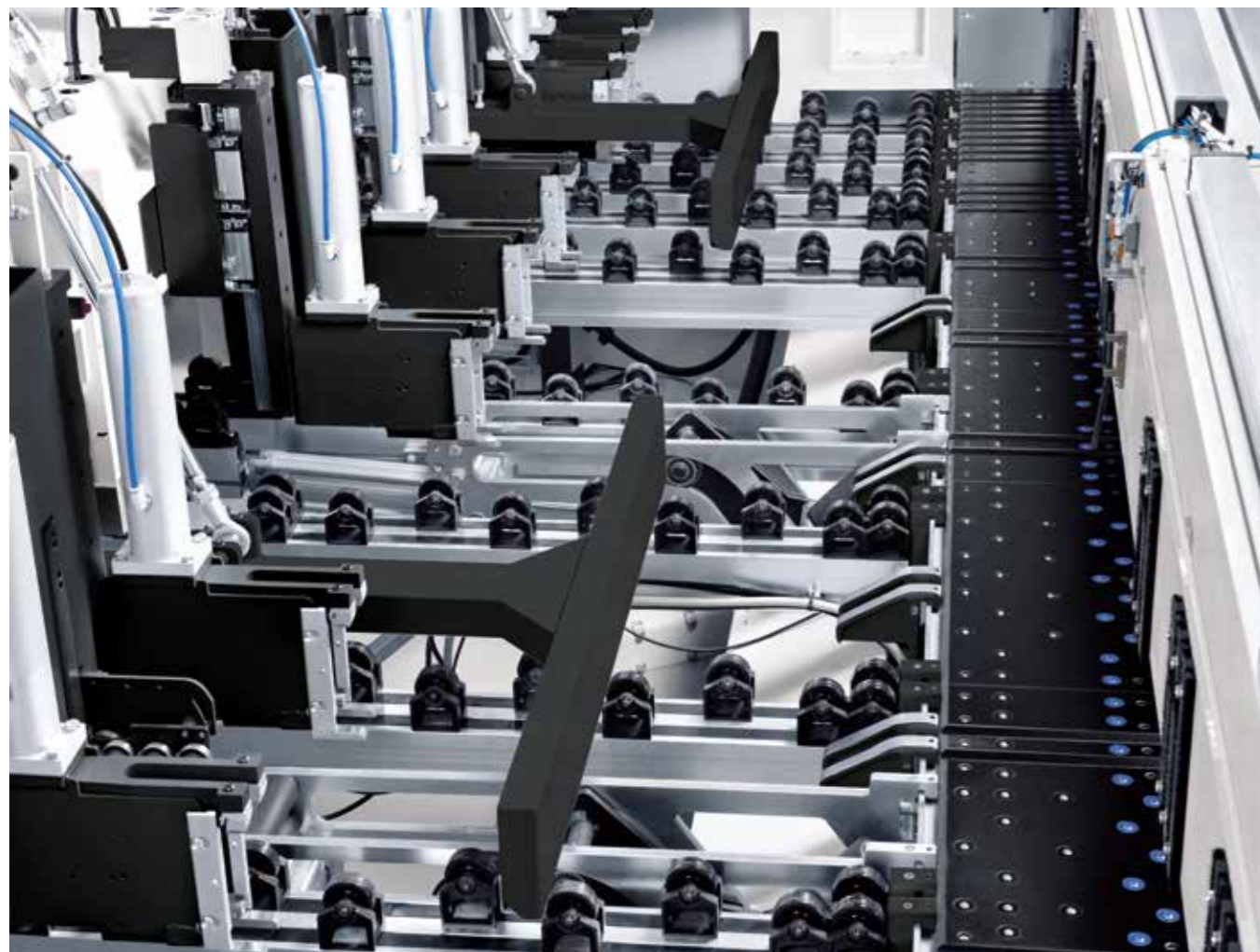

### Automatic outfeed fence

- Pushes panel remnants from the rear machine table across the cutting line to the front
- You no longer need to reach into the cutting area
- Ergonomic



### Rotation device for headcuts

- Process integrated perfectly in the machine cycle
- Labor-saving device for operators
- With automatic aligning function
- Less time required for preparation
- Easy operation
- Significant increase in output

[MORE AT HOMAG.COM](https://www.homag.com)



Rotation device

## Power Concept speeds up production

At the heart of this technology is a clamp that can be moved separately. Using this clamp, several strips with different cross cuts can be cut to length together, significantly increasing material throughput.

### POWER CONCEPT

Up to **40%** more output



Lower costs per cut



Significantly improved material flow



High material throughput



#### Power Concept professional works with:

- An additional clamp which works independently
- Clamps on the program fence that can be raised out of the overlapping work area as needed
- Re-sorting the strips directly at the saw so that they are ideally matched to Power Concept professional. This is based on existing optimization data for the shortest machining times

The Power Concept professional clamp positions the last strip at the cutting line while the program fence fetches the next panel or book of panels from the lifting table. Furthermore, Power Concept makes it possible to process two strips of different lengths simultaneously. Good to know: to ensure your machine operators can master the considerably faster pace of production with ease, we recommend combining systems with the HOMAG destacking concept (page 14) or with IntelliGuide (page 12).

#### Further benefits:

- Significantly shortened work cycles
- Attractively priced high-tech solution with minimum space requirement
- Precision cutting – even of very narrow strips

### MORE AT HOMAG.COM



Power Concept professional

## Solutions for special cutting tasks

Not only precise, but efficient. Under this banner, HOMAG offers you countless optional features for particular cutting tasks. Simply select your solution.

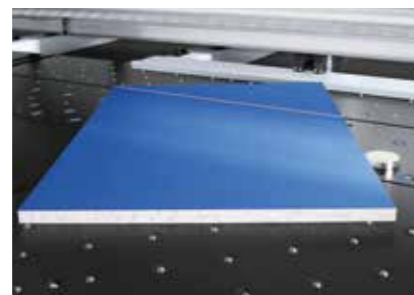
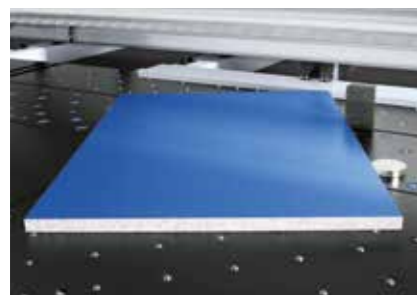

### Automatic angle cut device

This technology completes angle cuts fully automatically, after you have entered the respective data in the CADmatic control.

### Manual angle cut

The angle cut device allows you to control angle cuts using the CADmatic control software.

[MORE AT HOMAG.COM](https://www.homag.com)



Manual angle cut

Illustrations may show the technical principle but not the precise machine variant described. Further optional features, for example, may be shown.



### Kerfing and turbo grooving

These options save you an entire production step in subsequent processing. This is because your saw will also groove the panel material. The turbo-grooving option completes the grooves even much faster than a processing center.

[MORE AT HOMAG.COM](https://www.homag.com)



Kerfing

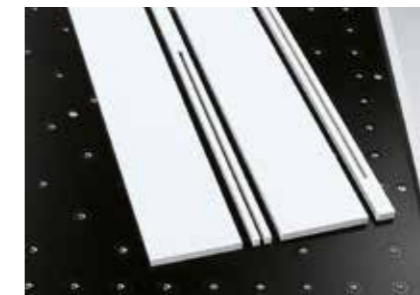

### Cut-out and stress elimination cut

Stress in the material is released when it is cut and can affect the quality of dimensions and cuts. The stress elimination cut option provides the solution. Systematic preliminary cuts can be defined during optimization and release the tension in the material. The additional cut-out feature also allows you to produce both cut-outs and intermittent grooves in panels, as required for kitchen sinks or doors, for example.



Cut-out function



Stress elimination cut

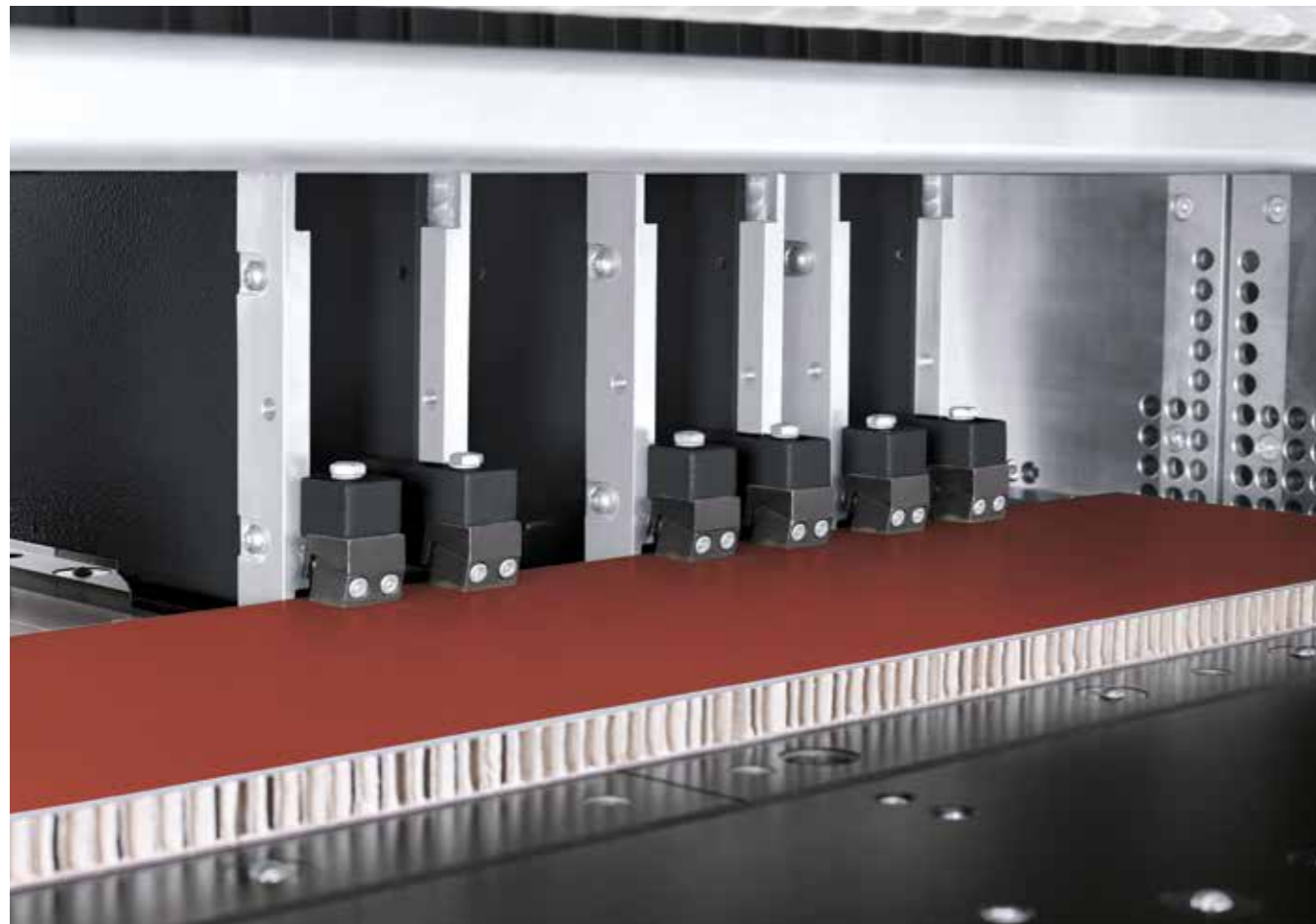

**Soft Touch for pressure-sensitive material**

As the diversity of materials increases, so do the requirements: pressure-sensitive lightweight boards, composite boards and plastic sheets are steadily gaining in importance. HOMAG has a range of solutions in its portfolio designed to meet these requirements. Simply ask your customer advisor.



**High-precision laser guide beam**

- Especially for solid wood, veneered panels and other materials with grain structure
- Pinpoint positioning right down the line

[MORE AT HOMAG.COM](https://www.homag.com)



Laser guide beam



**Extra-long cutting lengths**

All SAWTEQ B-400 saws are optionally available with a 5,600 mm cutting length.

**Additional clamps**

- For an even better grip on thin, narrow or smooth materials
- For increased material throughput

**Pneumatically operated trim stops**

The trim stops are attached to the clamps and are activated as needed by the CADmatic machine control.

- Rugged
- Adjustable to common panel thicknesses
- Gentle handling of sensitive materials with overhanging laminates or veneers
- Precise positioning

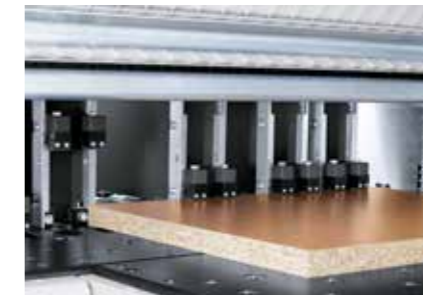

**Program-activated clamps**

This option prevents damage to edges. Now also possible: automatic clamp activation in "measuring" mode.



**Cutting gap closers**

Open and close automatically during the machine cycle, preventing narrow strips or trimmings from getting caught in the cutting line.



Pneumatically operated trim stops



Program-activated clamps



Cutting gap closers



## The perfect postforming cut

This option is available in two versions. Both include a scoring saw raised by a motor, complete with automatic adjustment.



### Version 1: ascending postforming

- Vertical-rise scoring saw (VRSS)
- Ensures perfect cuts on soft-formed and post-formed parts
- Maximum saw blade projection: 55 mm



### MORE AT HOMAG.COM



Postforming

### Version 2: ascending and vertical postforming

- VRSS as described in Version 1
- Additional vertical scoring saw (VSS) with a maximum saw blade projection of 90 mm
- Scores the edge of the entire book (scoring depth up to a maximum of 15 mm)
- Ideal for edges covered with veneer, paper, ABS etc.

## combiTec performs recuts during the cutting process

Efficiency means saving time, material and costs – just like combiTec. The innovative recut function is ideal for all businesses that work in small production batches or even produce in batch size 1.

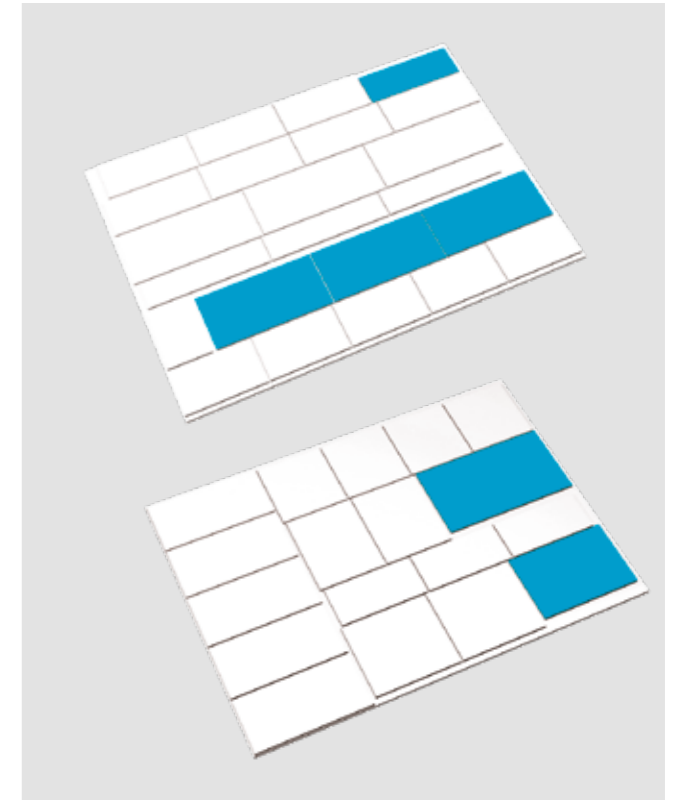

### combiTec speeds up batch size 1 production

The combiTec recut function is now available for all SAWTEQ B-400 saws and optimizes batch size 1 production. This innovation completes all recuts fully automatically during the regular cutting process. Even complex cutting patterns can be generated and flexibly implemented. That saves time and material, thus reducing costs.

### The benefits:

- Reduced material costs due to less waste
- No subsequent manual work
- High speed
- Low unit and tool costs
- Excellent price/performance ratio



combiTec for angular saw units



combiTec for single saws

## Air cushions for ergonomic operation

How can your machine operators handle heavy or excessively long parts with ease, even those that are susceptible to scratches? With innovative, tailored machine tables and air cushion tables from HOMAG of course! The choice is yours.



### Movable air cushion table

This air cushion table is easily moved along linear guides and offers you a mobile work surface and storage area. It allows you to move small panels, large panels or books of panels more ergonomically and with less risk of damage.



### Tiltable air cushion table

- Prevents thin materials from sagging
- Increases the work surface
- Primarily for large panels
- Folds down for easy access to the cutting line



### Extended air cushion tables (not shown)

- Extended from 2,160 mm to 2,810 mm
- Greater freedom of movement
- Better connection to destacking systems
- Very useful when cutting large-format panels

### Wider table elements

Air cushion tables are optionally available in a width of 800 mm instead of 650 mm. Just one, two, three or all four – whatever is best for your production.

[MORE AT HOMAG.COM](https://www.homag.com)



Air cushion tables

## dustEx: making dust a thing of the past!

The more dust and chips that can be taken away by the dust extraction system, the better. After all, dust and chips can cause scratches on sensitive surfaces.



### Patented dustEx technology

dustEx guides dust and chips on a direct route towards the dust extraction system. How does it work? Using combination air jets and an optimized dust extraction geometry at the right-angled fence. To complete the dustEx package, we recommend using a dust-trap curtain on either side of the pressure beam (page 53).

### Air jets throughout the machine table (standard feature for angular saw units)

Anyone working with sensitive material or especially heavy panels and books will benefit from the machine table being equipped with air jets throughout.

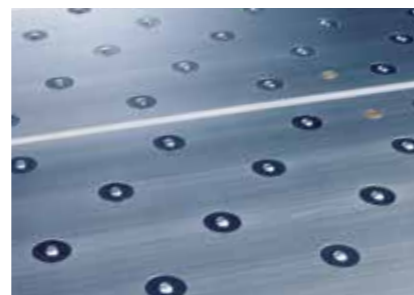

### Anodized aluminum machine bed plates

The special coating ensures exceptionally gentle material handling. Ideal for materials with highly sensitive surfaces.

[MORE AT HOMAG.COM](https://www.homag.com)



dustEx



### Dust-trap curtain on both sides

- Attached to the front and rear of the pressure beam. Dust-trap curtain only at the rear when combined with the label printer at the pressure beam (page 55)
- Protects operators from dust
- Improves dust extraction
- Ideal for dust cuts

### Designer lighting (not shown)

Comprising:

- LED illumination of the cutting line
- LED illumination of the saw blade change area
- LED illumination in the switch cabinet

The benefit: simple, ergonomic working practices that protect the eyes.

## Custom part labeling

Whether generated automatically or manually on demand: with labeling solutions from HOMAG, you can clearly label each individual part and ensure parts can be identified at subsequent processing stations.



### Label printer

The label printer from HOMAG allows you to print customized labels directly at the saw and design them to include bar codes, text and graphics if required. If you also use our Cut Rite optimization software, the material goes directly to the next process step with printed instructions. In this way, you can integrate the saw perfectly in your production flow.



### Swiveling label printer

The label printer can also be swiveled horizontally to ensure ergonomic working practices. Available in combination with the parts buffer (page 15).



### Panel labeling system

The innovation for saws with automatic storage integration: the HOMAG panel labeling system labels the panel before it is cut – independently of the saw, in non-productive time that previously went unused. It can also be combined with the feed-stacking table with integrated feed (page 36).

- Smallest part size 170 x 170 mm
- Up to 10 labels/min, optionally up to 15 labels/min
- Labeling independent of cutting process
- Saves time, because non-productive time is used productively
- Optimizes handling during destacking, because all the parts are already labeled
- Simplifies and speeds up production processes
- Automated parts tracking
- Can be retrofitted
- For smooth processes



### Fully automatic labeling

The labeler is located near the pressure beam, i.e. in your field of vision, and labels the finished parts/books – even when several strips are processed simultaneously side by side (Power Concept). It makes no difference whether you feed the panels from the front or the rear. If desired, the position of the label can be individually controlled.

- Suitable for panels, offcuts and finished parts
- Gives precise details of the destacking location
- Gives precise instructions for further processing
- Saves time
- Minimizes errors
- Guides the operator

## MORE AT HOMAG.COM



Manual labeling



Panel labeling system



Fully automatic labeling

## module45 – giving your saw the scope to produce bevel cuts

With module45, you can now produce all cuts, including bevels, on one and the same saw. Work efficiently and flexibly without changing station, at seamlessly adjustable angles ranging from 0 to 46 degrees.

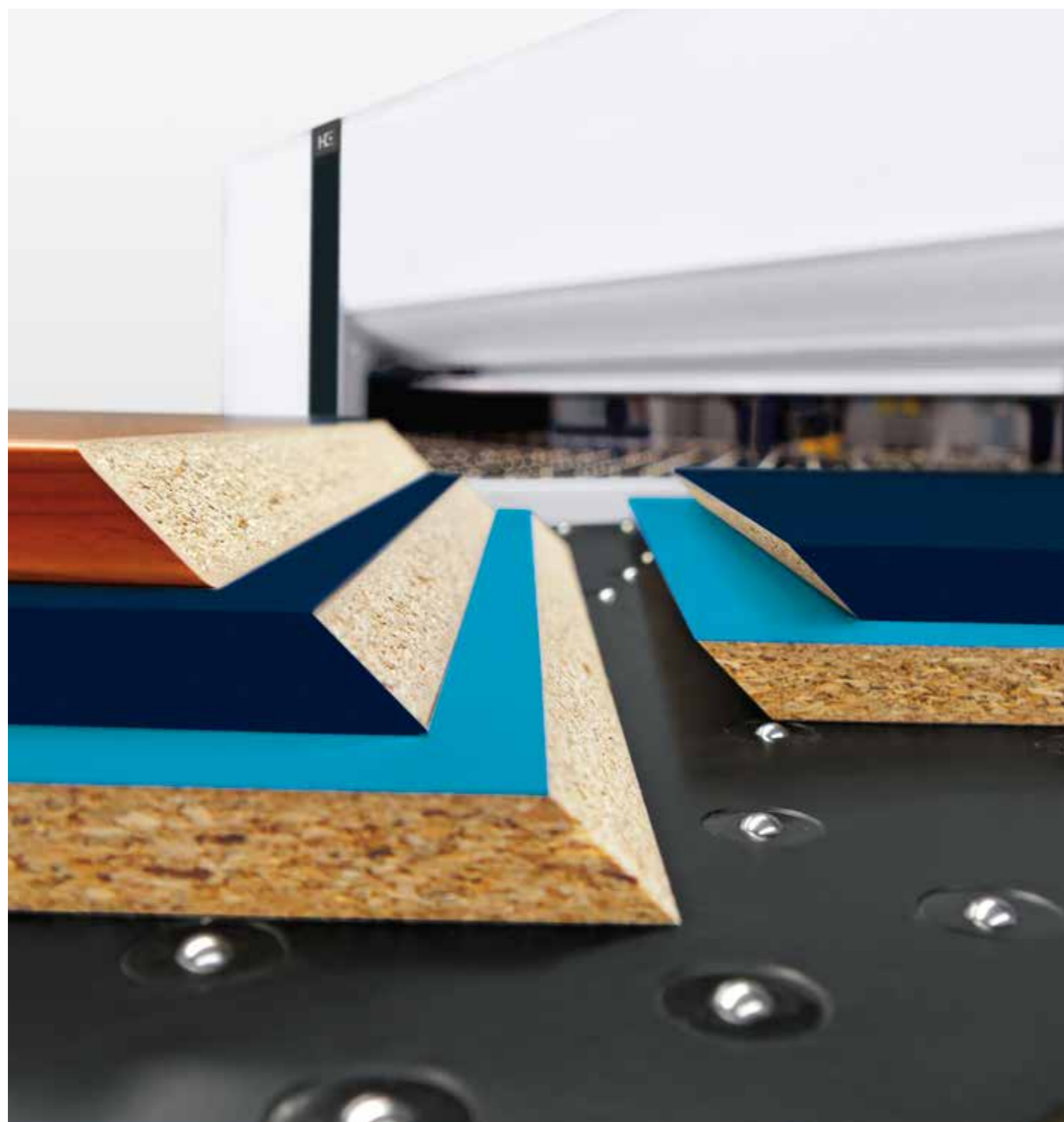

Illustrations may show the technical principle but not the precise machine variant described. Further optional features, for example, may be shown.



### The benefits of module45

- Low investment costs, great benefits
- You no longer need a sliding table saw for bevel cuts
- Higher energy efficiency with two machines in one
- Easy one-man operation
- Less waste and higher quality thanks to less transport damage as the material remains on the one machine
- Greater ergonomic and safety benefits than a circular saw
- Unbeatable cost/benefit ratio
- Available as retrofit on request

### The technology

- module45 consists of a stationary saw carriage with a tilting saw blade that can be seamlessly adjusted to angles of 0 to 46 degrees
- When viewed from the front, the unit is integrated in the air cushion table on the far left
- The table plate can be opened, allowing easy access to the saw carriage for changing saw blades
- Other features include dedicated systems for contact pressure and dust extraction, plus a fold-down right-angled fence for maximum handling flexibility at the front of the saw

### Incorporate bevels into cutting patterns

Now you can also incorporate bevel cuts into your cutting patterns: either using the Cut Rite optimization software when preparing work in the office, or when inputting the patterns directly in CADmatic. Parts to be processed with module45 are then cut (oversize) and the operator only needs to set the angle of the bevel on module45 and start the cut.

[MORE AT HOMAG.COM](https://www.homag.com)



module45

## Extras for improved efficiency and control

Do you want to produce even more efficiently and monitor production processes with greater ease? You will find the right technology solutions for your cutting application here.

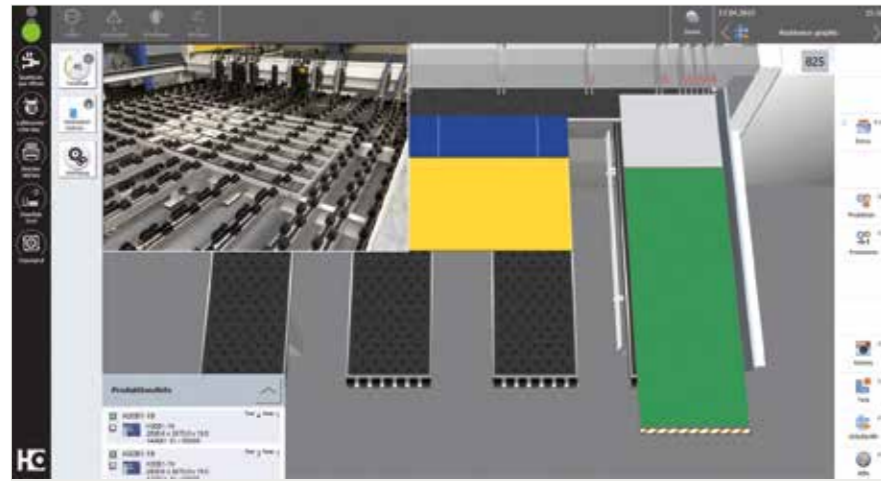

### Everything in view – with video monitoring

- Display of the camera image via the CADmatic control software
- You always have the rear machine table and feed system in view
- Camera pictures can be recorded if required for error diagnostics and workflow optimization purposes and sent to the HOMAG Service department



### Patented: camera-controlled scoring saw adjustment

This option allows the scoring saw to be adjusted fully automatically. Manual adjustment is still possible – controlled by the software via input on the touchscreen.

Its strengths:

- Optimum measuring results: the camera selects the color of lighting and the exposure time itself
- The simple adjustment takes no longer than a minute
- High-precision setting



### Additional start-stop button

- Allows the program sequence to be started independently of the control panel
- Equipped with an emergency stop button

TECHNICAL DATA*			
Model	B-400	B-400 with lifting table	B-400 as angular saw unit
Saw blade projection (mm)	110 (optional: 125)	110 (optional: 125)	110 (optional: 125)
Cutting length/width (mm)	3,200/3,800/4,300/5,600*****	3,200/3,800/4,300/5,600*****	Rip saw: 3,200/4,300/5,600 Cross cut saw: 2,200 (2,100*****)
Lifting table width (mm)		2,200	2,200
Program fence speed (m/min)	up to 90**	up to 90**	Rip saw: up to 90** Cross-cut saw: up to 130**
Saw carriage speed (m/min)	up to 130 (optional: 150)	up to 130 (optional: 150)	up to 130 (optional: 150)
Main saw motor (kW)	50 Hz: 18 (optional: 24) 60 Hz: 21 (optional: 28)	50 Hz: 18 (optional: 24) 60 Hz: 21 (optional: 28)	50 Hz: 18 (optional: 24) 60 Hz: 21 (optional: 28)
Scoring saw motor (kW)	2.2	2.2	2.2
Average total air requirement (NI/min)	120	210	450
Required compressed air supply (bar)	6	6	6
Extraction system (m³/h)	3,800 (5,230****), 26 m/sec	3,800 (5,230****), 26 m/sec	6,600 (9,030****), 26 m/sec
Max. stack height without pit (mm)	–	560 (up to 4,300 cutting length) 450 (up to 5,600 cutting length)	560 (up to 4,300 cutting length) 450 (up to 5,600 cutting length)
Max. stack weight (t)	–	4 (for 5,600 mm cutting length: 7)	4 (for 5,600 mm cutting length: 7)
Working height (mm)	920	920	920
Air cushion tables (mm)	3/3/4/5 x 2,160	3/3/4/5 x 2,160	2 x 2,160

\* Values relate to the standard version

\*\* Forwards 25 m/min

\*\*\* Dim. A: incl. 64 mm for extraction connection. Dim. C: standard program fence width. There are wider dimensions for the lifting table.

\*\*\*\* For the 5,600 mm cutting length

\*\*\*\*\* Only available in right-handed version

\*\*\*\*\* Maximum width that can be aligned

Technical data and photographs are not binding in every detail. We reserve the right to make changes in the course of further development.

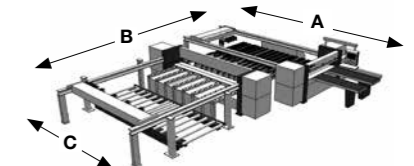
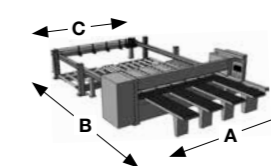
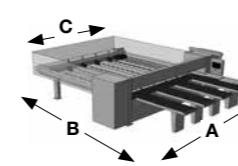

MACHINE DIMENSIONS***			
B-400	A (mm)	B (mm)	C (mm)
B-400/32/32	5,364	6,543	3,709
B-400/38/32	5,924	6,543	4,269
B-400/38/38	5,924	7,143	4,269
B-400/43/32	6,514	6,543	4,859
B-400/43/43	6,514	7,693	4,859
B-400/56/56	7,864	9,043	6,209

MACHINE DIMENSIONS***			
B-400 with lifting table	A (mm)	B (mm)	C (mm)
B-400/32/22	5,364	9,963	3,636
B-400/38/22	5,924	9,963	4,196
B-400/43/22	6,514	9,963	4,786
B-400/56/22	7,864	11,413	6,136

MACHINE DIMENSIONS***			
B-400 as angular saw unit	A (mm)	B (mm)	C (mm)
B-400/32/22	8,020	11,760	3,636
B-400/43/22	9,170	11,760	4,786
B-400/56/22	10,520	11,760	6,136

# HC LIFE CYCLE SERVICES

Optimal service and individual consultations are included in the purchase of our machines. We support you with service innovations and products which are especially tailored to your requirements. With short response times and fast

customer solutions we guarantee consistently high availability and economical production – over the entire life cycle of your machine.



## REMOTE SERVICE

- Hotline support via remote diagnosis by our trained experts regarding control, mechanics and process technology. Thus, more than 90% less on-site service required and consequently a faster solution for you!
- The ServiceBoard App helps to solve tasks in a fast, simple and concrete way. This is achieved by mobile live video diagnosis, automatic sending of service requests or the online spare parts catalog eParts.



## SPARE PARTS SERVICE

- High spare parts availability and fast delivery.
- Ensuring quality by predefined spare parts and wear parts kits, comprising original spare parts.
- Identify and inquire for spare parts online under [www.eParts.de](http://www.eParts.de) 24/7, or buy even faster and more comfortably in the new HOMAG Webshop eCommerce.



## MODERNIZATION

- Keep your machinery up to date and increase your productivity as well as your product quality. This is how you can meet tomorrow's requirements today!
- We support you with upgrades, modernization as well as individual consultancy and developments.



## DIGITAL SERVICES

- ISN (IntelliServiceNet) – The new remote service solution of the future! Fast restart of production because the remote service employee has extensive access to relevant physical data.
- IntelliAdvice App – provides help for self-help. The preventive solutions proposed in the new App are the combination of our experiences and existing machine data.



## SOFTWARE

- Telephone support and consultancy through software support.
- Digitalization of your spare parts via 3D scanning saves time and money compared to new programming.
- Subsequent networking of your machinery with intelligent software solutions ranging from construction to production.



## FIELD SERVICE

- Increased machine availability and product quality by certified service staff.
- Regular checks through maintenance / inspection guarantee the highest quality of your products.
- We offer you the highest availability of technicians in order to reduce downtimes in case of unpredictable troubles.



## TRAINING

- Thanks to training perfectly suited to your requirements, your machine operators can optimally operate and maintain the HOMAG machines.
- Training also includes customer-specific training documents with exercises proven in practice.
- Online training and webinars. Learn without traveling, meet your trainer in the digital classroom.

For you more than...

**1,350**  
service employees worldwide

**90%**  
less on-site service thanks to successful remote diagnosis

**5,000**  
customer training sessions per / year

**150,000**  
machines, all electronically documented in 28 different languages – in eParts





## HOMAG Group AG

info@homag.com  
www.homag.com



## YOUR SOLUTION