

scm

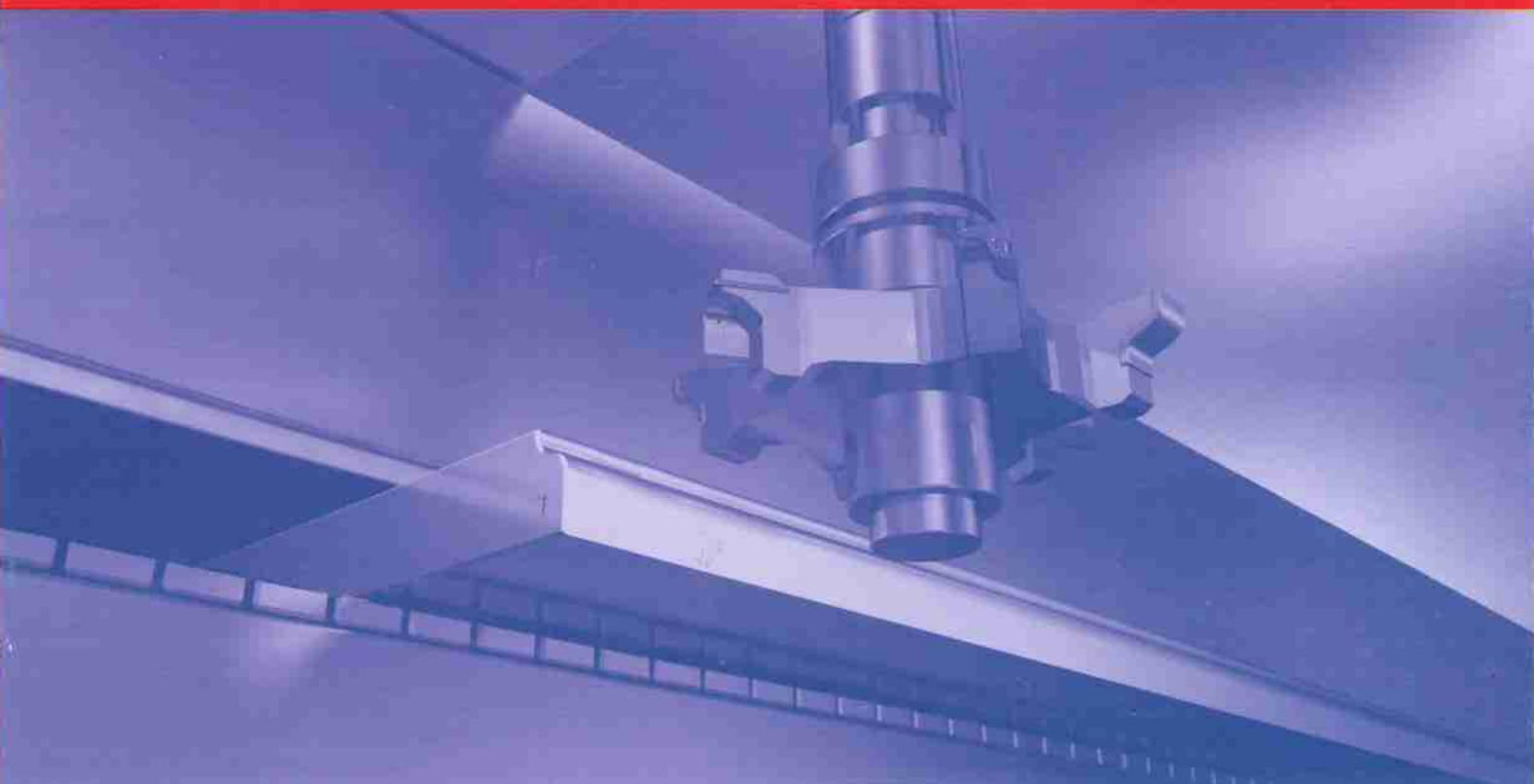

Squadratrice - tenonatrice
monolaterale automatica
Automatic single end tenoner

Concept Mono



 **scm**

Tecnologia d'avanguardia
Leading edge technology



Concept Mono

- Unità di lavoro con cambio utensile automatico Rapid 24.
- Sagomatore elettronico
- Controllo numerico touch screen
- Working units with Rapid 24 automatic tool changer,
- CNC shaping device,
- Control unit with touch screen



Macchina in configurazione CE
Machine in EC configuration

Concept Mono
Squadatrice - tenonatrice
monolaterale automatica
Automatic single end tenoner

Le soluzioni

The solutions

Struttura portante monoblocco progettata e costruita con i sistemi tecnologici più avanzati (CAD-CAM) che garantiscono massima sicurezza ed affidabilità.

Monobloc structure designed and built with advanced technological systems (CAD-CAM) to guarantee the highest safety and reliability.

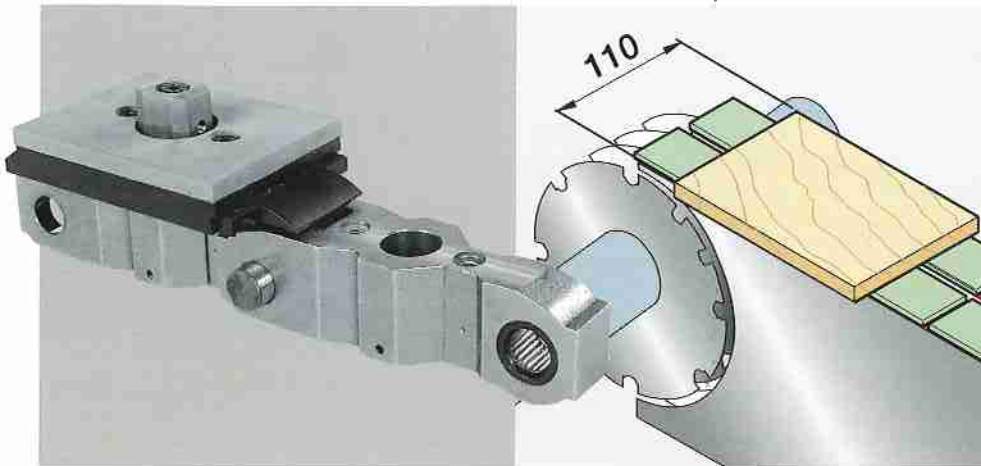
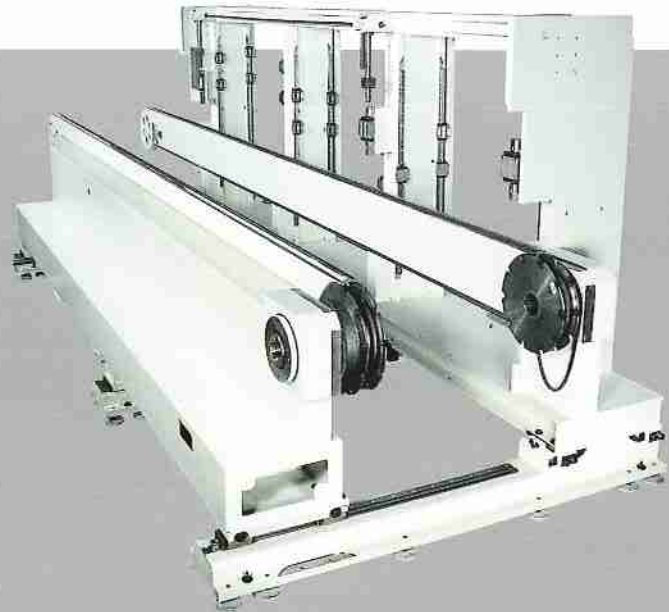

Catena ad alte prestazioni, costituita da robustissimi elementi in acciaio sinterizzato. Perno di giunzione su cuscinetti lubrificati a vita. Larghezza pezzi min. 110 mm (opzionale)

High performance feed chain, composed of strong sintered steel links. Links have hardened and ground pins with long life lubricated ball bearings. Min. working width 110 mm (option)



Elettromandrino con attacco HSK 63F
- velocità di rotazione 1000-18.000 g/min.
- potenza fino a 11 kW (15 HP)
- cambio utensile automatico con magazzini fino a 24 posizioni

Electro-spindle with HSK 63F tool taper
- Rotation speed from 1000 to 18,000 rpm
- Power up to 11 kW (15 HP)
- Automatic tool changer with tool magazine up to 24 positions

Concept Mono

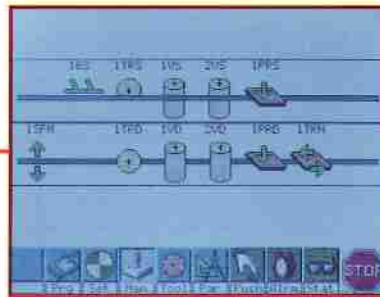

Mobile 10
 Controllo numerico di ultima generazione. Software e Hardware modulare multilivello. Consente di:

- archiviare, visualizzare e gestire quote di lavoro
- memorizzare quote/programmi (auto-apprendimento)
- Tecnologia Touch screen.

Mobile 10
 Next generation control unit
 Modular software and modular multi-level hardware.
 Enabling to:

- place on file, visualize and manage working dimensions
- store new working dimensions or programs (self learning)
- Touch screen technology

Copytronic 90 PC:
 sagomatore a CNC per la realizzazione di profili sagomati

Copytronic 90 PC:
 CNC shaping device for the production of shaped mouldings

UFFICIO - OFFICE

FLOPPY DISK



ON-LINE

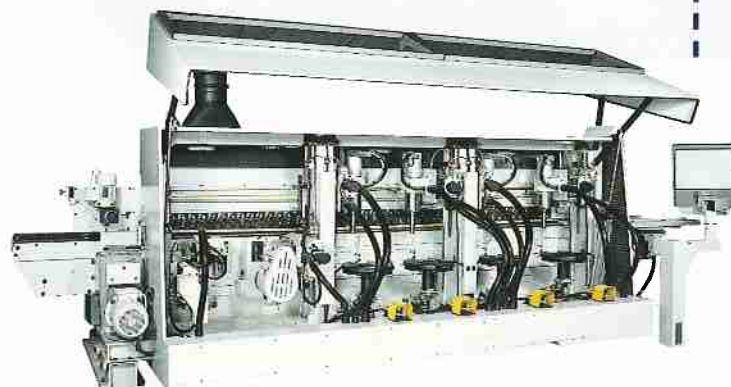

Concept Mono

Dimensioni d'ingombro

Dimensions

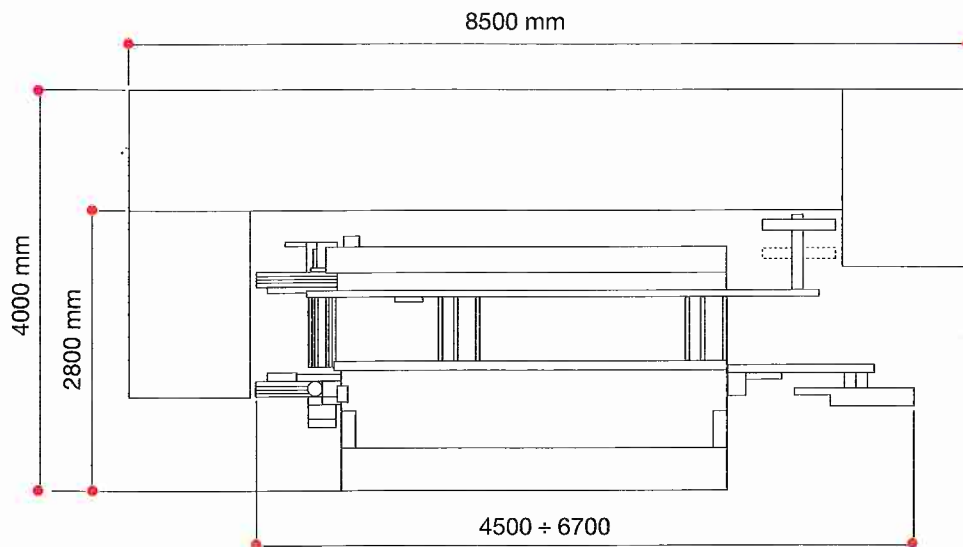

Dati tecnici / Technical specifications

		Concept Mono	
Apertura max spalla mobile	Max. mobile beam opening	mm	800
Altezza max di lavoro	Max working height	mm	100
Passaggio fra cingolo e colonne	Clearance between chain and column	mm	150
Velocità di avanzamento regolabile	Adjustable feed speed	m/min	5÷30
Distanza fra battute	Distance between reference stops	mm	500
Guida di sinistra posta in entrata con esclusione pneumatica on/off	Links fence in infeed with on/off pneumatic exclusion		STD
Apertura tot. con guida di destra ad asse continuo (opzionale)	Opening right fence from CNC (option)	mm	1500

Per esigenze dimostrative alcune foto riproducono macchine complete di accessori. Senza nessun preavviso i dati tecnici possono essere modificati, le modifiche non influenzano la sicurezza prevista dalle norme CE.

SCM reserves the right to modify technical specifications without prior notice, provided that such modifications do not affect safety foreseen by EC certification.

SCM. La più ampia gamma di macchine per la lavorazione del legno SCM. Woodworking machinery: the widest range of products



SCM produce da oltre 50 anni macchine per la lavorazione del legno e costituisce il nucleo storico dell'omonimo Gruppo che con 3000 dipendenti, 18 stabilimenti, 23 filiali ed un'esportazione pari al 70% della produzione, si colloca tra i maggiori produttori mondiali del settore. SCM produce - in stabilimenti certificati ISO9001 - la più ampia gamma di macchine per la lavorazione del legno, dalle macchine per artigiani ai centri di lavoro CNC, alle grandi linee integrate per la lavorazione del legno massiccio. In tutto il mondo tecnici specializzati forniscono ai clienti un servizio di assistenza rapido ed efficace avvalendosi anche di un sistema di telediagnosi computerizzata.

SCM has been producing woodworking machinery for 50 years and represents the nucleus of SCM Group. With a total of 3000 employees, 18 factories, 23 subsidiaries and an export of 70%, SCM is one of the world's top producers of woodworking equipment. SCM produces, in premises certified according to ISO 9001 standards, the widest range of machines for secondary wood machining, from machines for small woodworking companies to CNC work centres, to high production integrated lines for the machining of solid wood. Specialized technicians all over the world are able to supply an efficient and rapid after-sale service to SCM customers because full use is made of a system of remote computerised diagnostics.

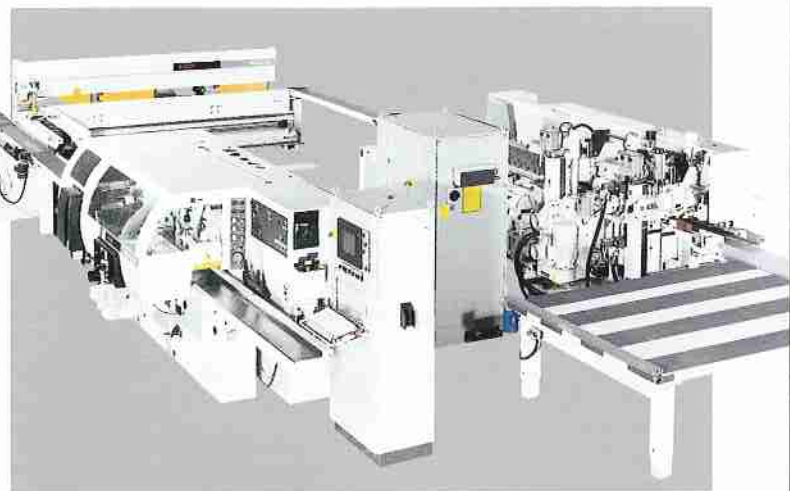

SINCERT



scm

RM



S

S

N



SCM GROUP spa - Via Emilia, 71 - 47900 Rimini (RN) - Italy
Tel. +39/0541/700111 - Fax +39/0541/700181 - www.scmgroup.com - E-mail: scm@scmgroup.com