



flexstore

automatic storage systems, **a solution for every requirement**

flexstore, is the SCM solution for the needs of companies making items to order with “just-in-time” production: processing orders quickly, keeping costs down and quality standards and productivity high.

flexstore, the range of automatic storage systems that thanks to their flexibility, user-friendliness and modular set-ups caters for every logistics need both for small- and large-scale companies.

flexstore s, the integrated solution with modular set-ups;

flexstore el, the more complete and versatile solution for storage management, even serving multiple machines using different technologies;

flexstore hp, the High Performance solution for maximum customisation

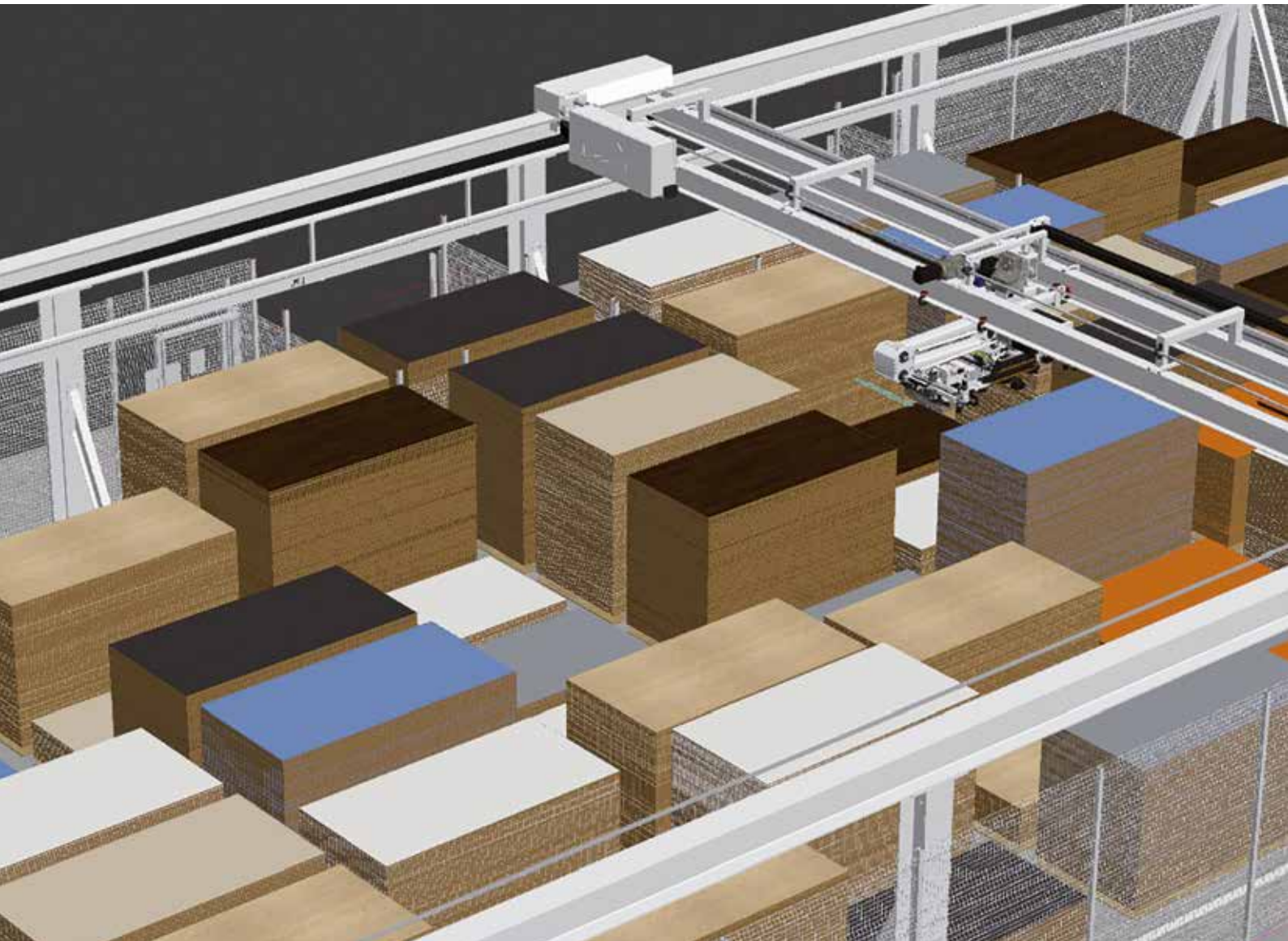

		flexstore S	flexstore EL	flexstore HP
Storage system width	m	7	7, 9, 12	7 - 16
Storage system length	m	12, 16.5, 21	12 - 60	12 - 60 or higher
Axis speed (X,Y,Z)	m/min	80, 80, 30	80, 80, 30	100, 100, 60
Panel width	mm	1200 ÷ 2.200*	800 ÷ 2.200 400 ÷ 2.200 (opt.)	800 ÷ 2.200 400 ÷ 2.200 (opt.)
Panel length	mm	2.400 ÷ 4.250*	1.800 ÷ 3.200 1.800 ÷ 4.250 (opt.)	1.800 ÷ 3.600 1.800 ÷ 5.600 (opt.)
Panel thickness	mm	Covered: 10 ÷ 40 Unmachined: 16 ÷ 40	Covered: 10 ÷ 40 (opt. 3 ÷ 40) Unmachined MDF: 16 ÷ 40 (opt. 3 ÷ 40) Unmachined chipboard: 16 ÷ 40 (opt. 6 ÷ 40)	Covered: 10 ÷ 40 (opt. 3 ÷ 40) Unmachined MDF: 16 ÷ 40 (opt. 3 ÷ 40) Unmachined chipboard: 16 ÷ 40 (opt. 6 ÷ 40)
Stack maximum height	mm	1900	2000	up to 2000 (opt. 2500)
Panel maximum weight	kg	150	200	350
Loading station:		Single	Single (opt. double + additional)	Single (opt. double + additional)

* depends on configuration



provides:

- increased productivity with batch 1 management;
- faster order processing;
- greater flexibility with a streamlined, efficient production flow;
- the possibility of improved integration in panel sizing operations and nesting machining;
- better overall plant performance.
- improved logistical efficiency, reducing labour requirements;
- higher finished product quality, due to the absence of sliding movements

CONTENTS

flexstore s	p.04
flexstore el	p.06
flexstore hp	p.08
examples of solutions	p.10
software	p.16

flexstore s

the integrated solution with **modular set-up**

The user-friendly storage system that guarantees an optimised material flow and machining times with a modest investment and excellent functions. **flexstore s** is the practical, dynamic panel management system, able to automatically feed the storage area and the machine, saving a considerable amount of material and time.

Guarantees:

a solution fully integrated with the machine:

- a single control station for managing the production process of the entire cell;
- a single set of cell diagnostics;
- material always available, not moved with a forklift truck;
- top quality finished product, thanks to the absence of sliding movements;
- reduced times, space taken up and labour requirements.

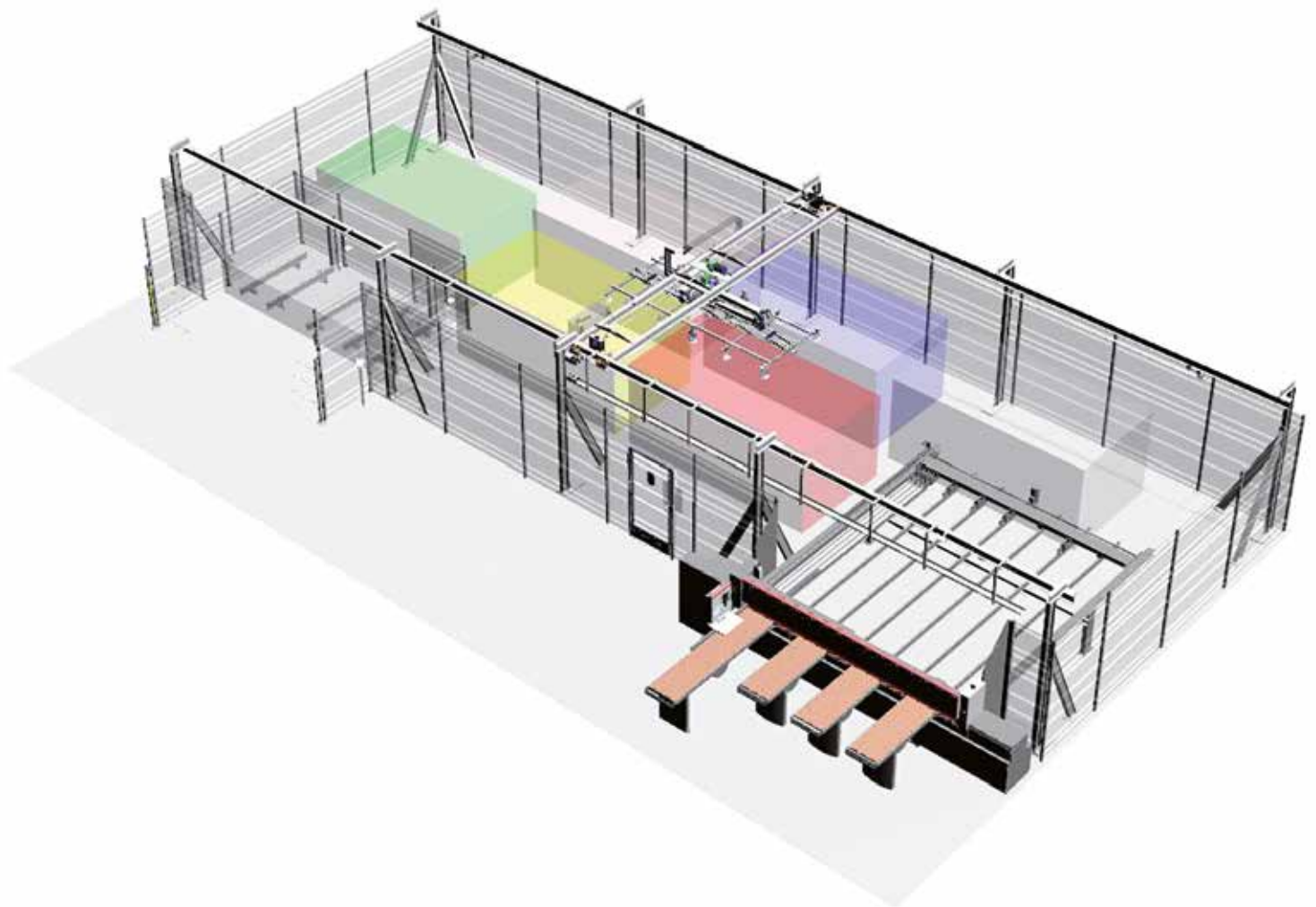

Suction cup surface lifting system with articulated arms.
Searching for, placing, cutting or moving material has never been this simple for the operator.

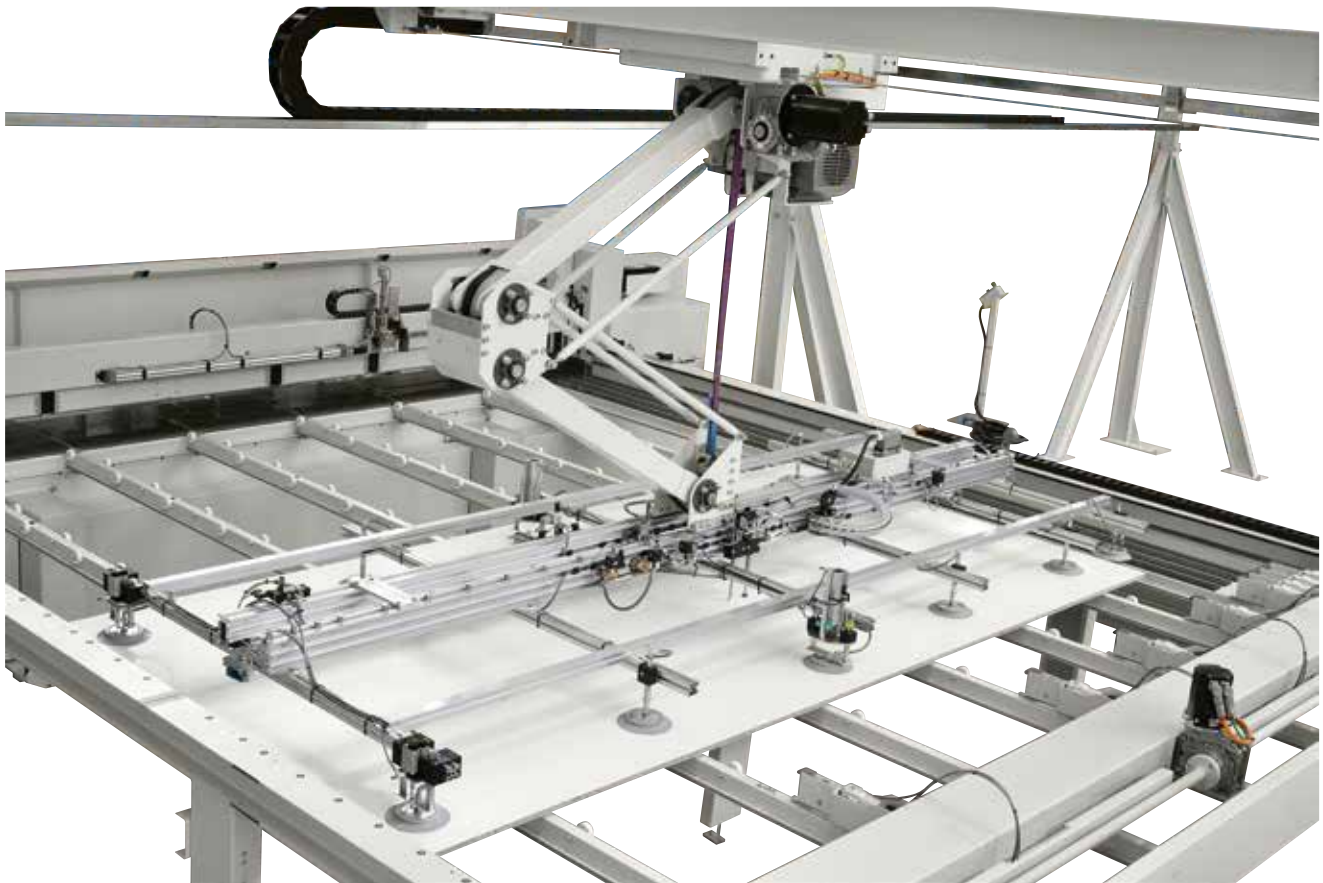

Loading and unloading bay: **panel always ready** and reduced stack changes. The operator just has to load the new stacks. The loading gantry will transfer the panels to the individual locations. Pre-detachment of the panels, even with the most breathable materials, is **always guaranteed** thanks to the fixed pickup surface equipped with suitable devices.

flexstore el

the **more complete and versatile** solution

Automatic storage system, ideal for medium and large companies. Can serve multiple machines that use different technologies, guaranteeing precision, high component quality and great reliability.

The excellent materials management permits high productivity and flexible machining.

Guarantees:

- material savings thanks to management of material remaining after machining;
- maximum flexibility for multi-function cells;
- optimised material management in the production process: less space occupied, without compromising on efficiency;
- reduced risk of damage to material thanks to the absence of sliding movements;
- full traceability for batch 1 production with automatic labelling, the same for all of the machines, or independent for each individual machine;
- machines with integrated production process;
- reduced order execution times





Secure, precise panel transfer. The suction cup arm has a device for pneumatically-operated panel front detachment, and a weight detection device for checking that separation has been achieved. Cycle and thin panel management devices.



The suction cup arm, capable of rotation, automatically adapts to the different lengths and widths of the panels to be picked up, it can be equipped with the device to adjust the panel positioning. In the presence of a beam saw, panels can also be loaded transversally.

flexstore hp

the solution **for industrial production**

The largest model in the range, this guarantees maximum sturdiness and power, even for storage systems with openings measuring **more than 12 metres**, offering more space for a wide variety of materials.

The **high performance** version is designed to allow extensive customisation and fulfil any production requirements.

Guarantees:

- top speed
- maximum lifting capacity
- largest dimensions
- the most versatile configuration

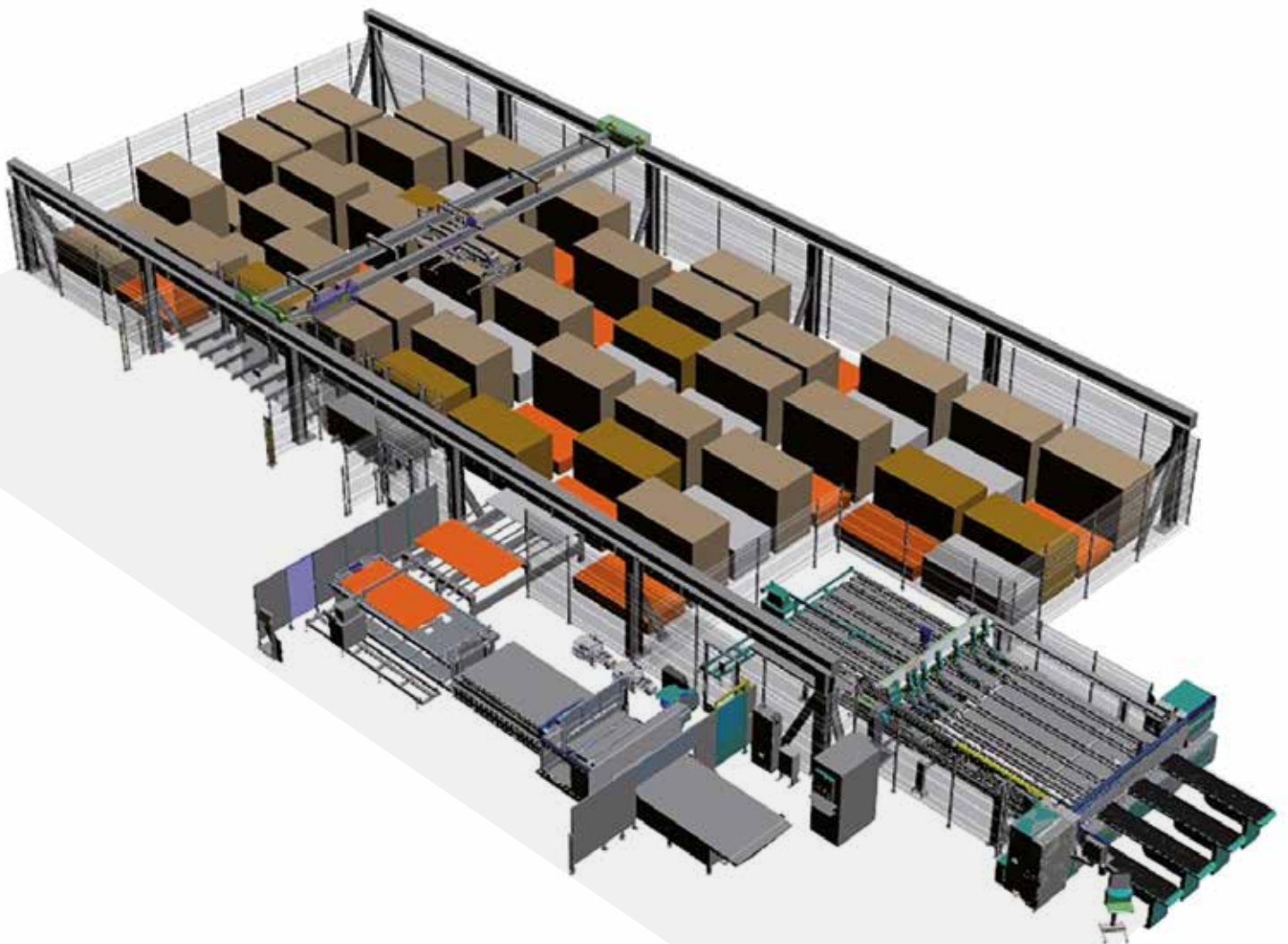



Suction cup arm designed to include **thin panel management** devices.



The steel structure allows **vibration-free movements** even in large storage systems.

flexstore s

the solution for all requirements

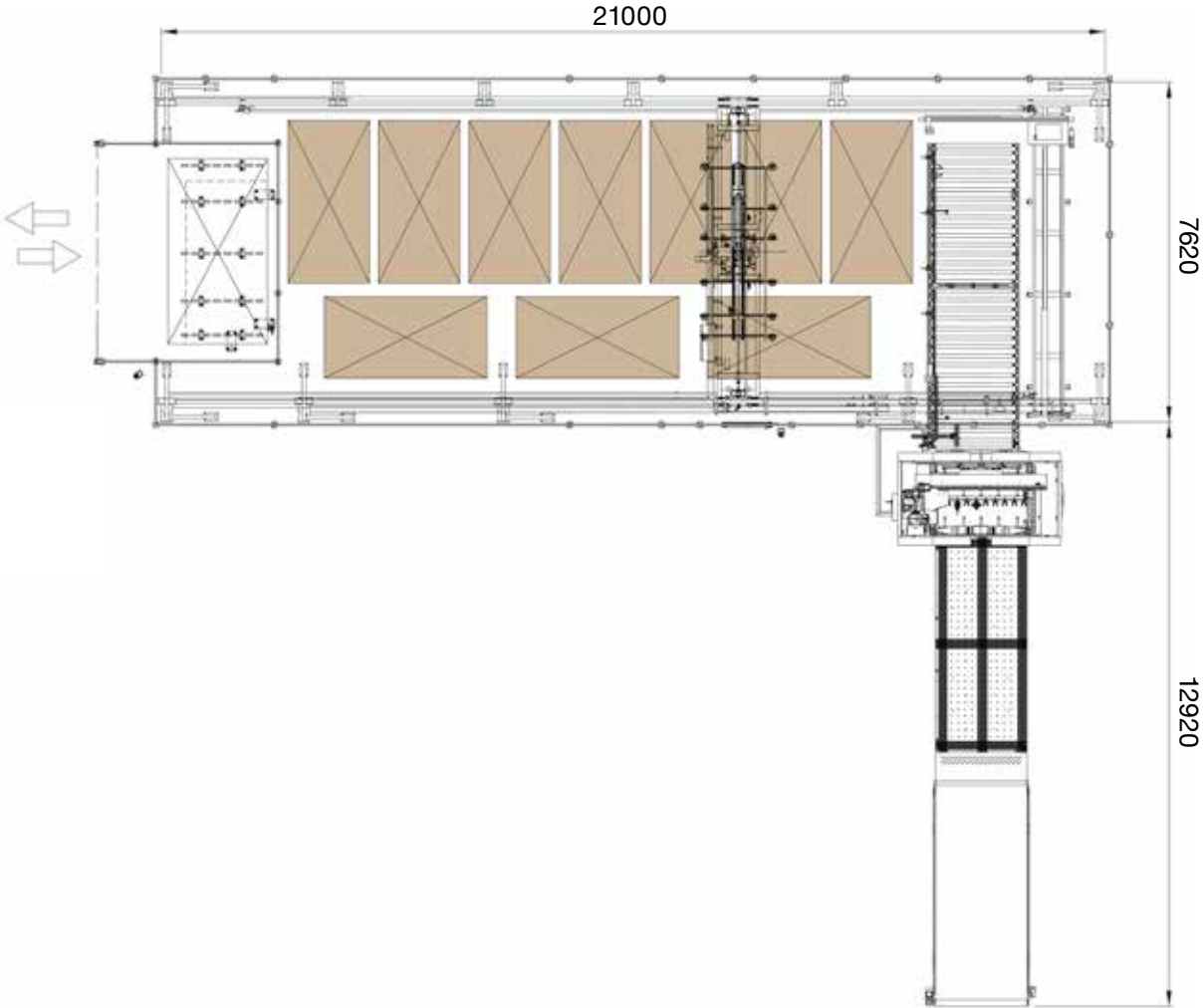
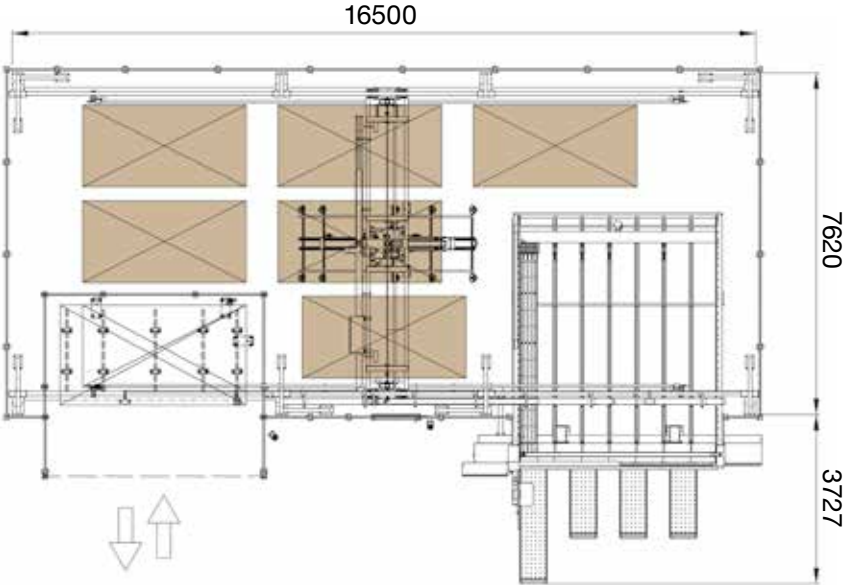

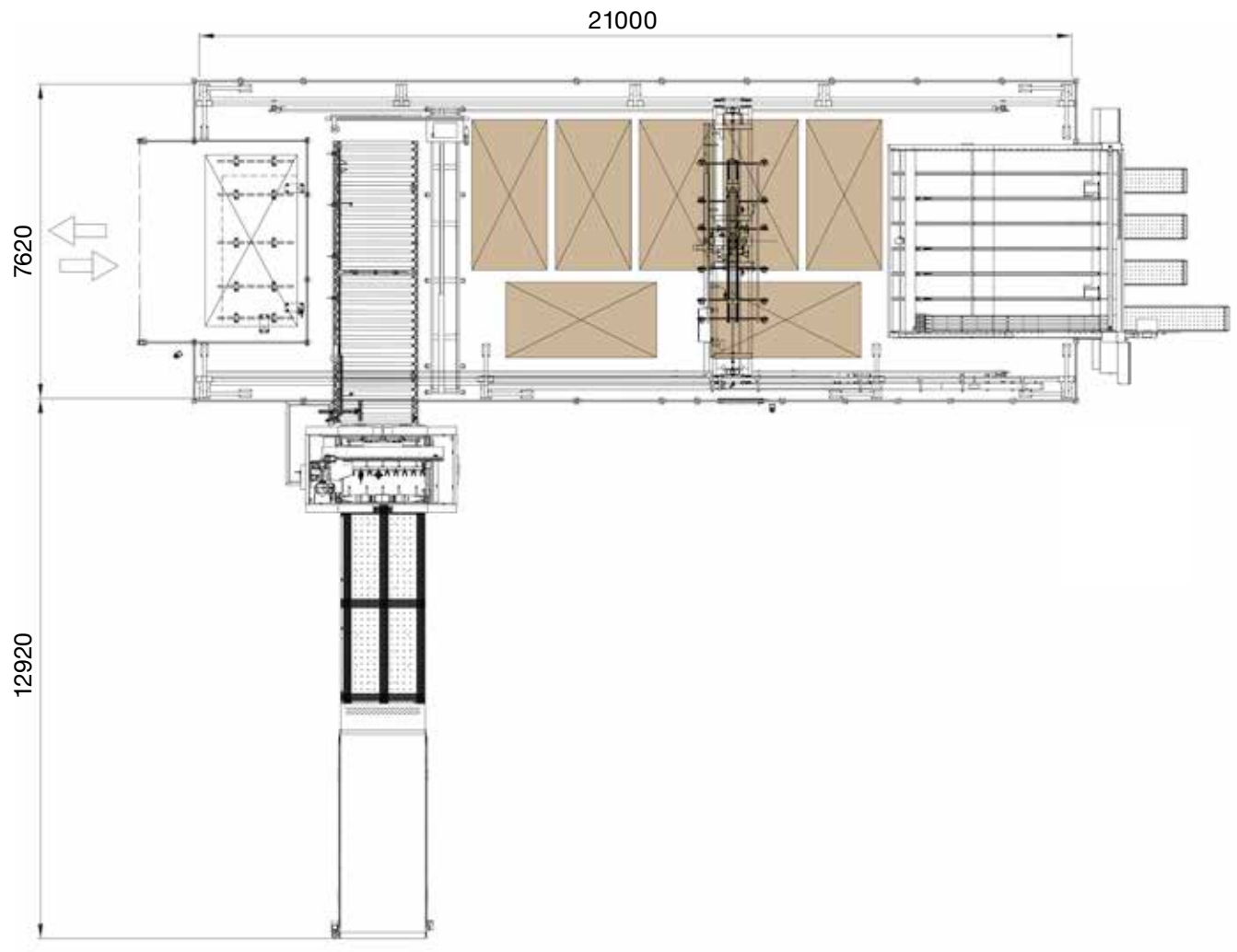
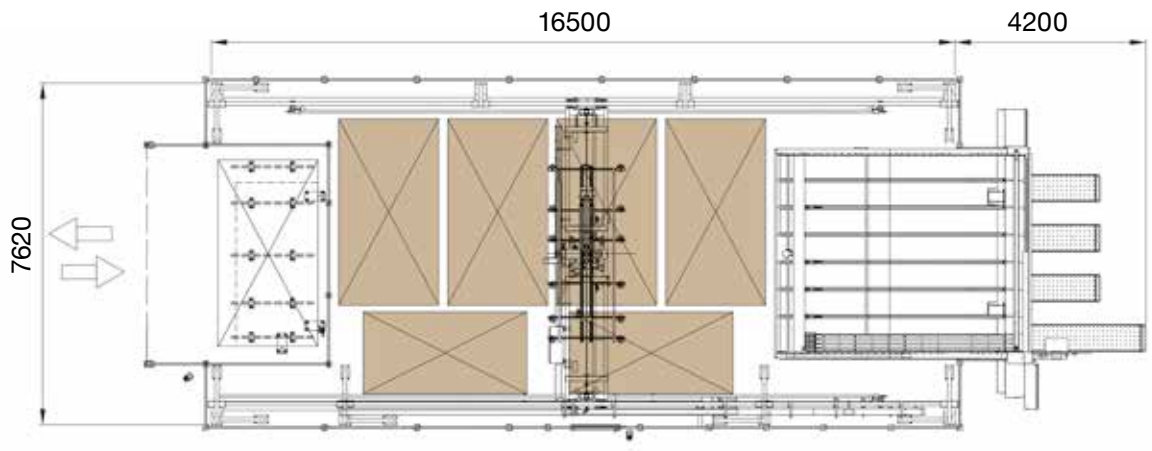

flexstore el

the solution for all requirements

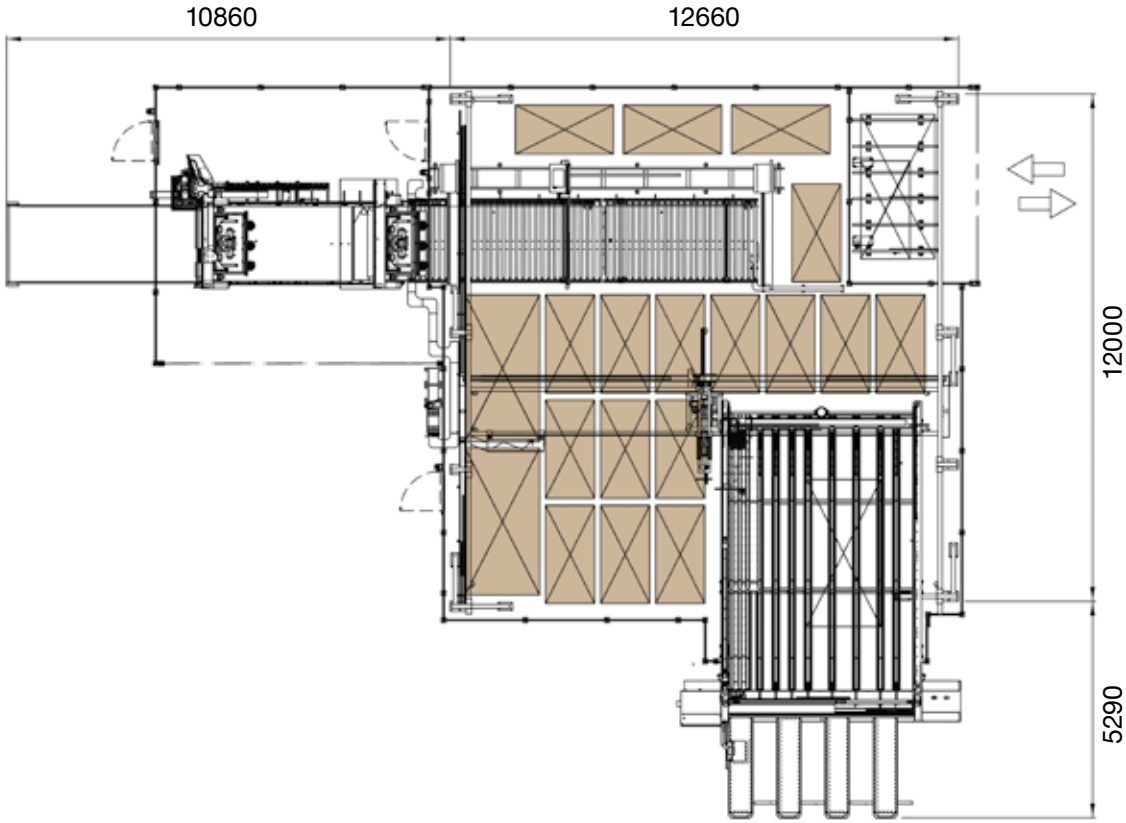
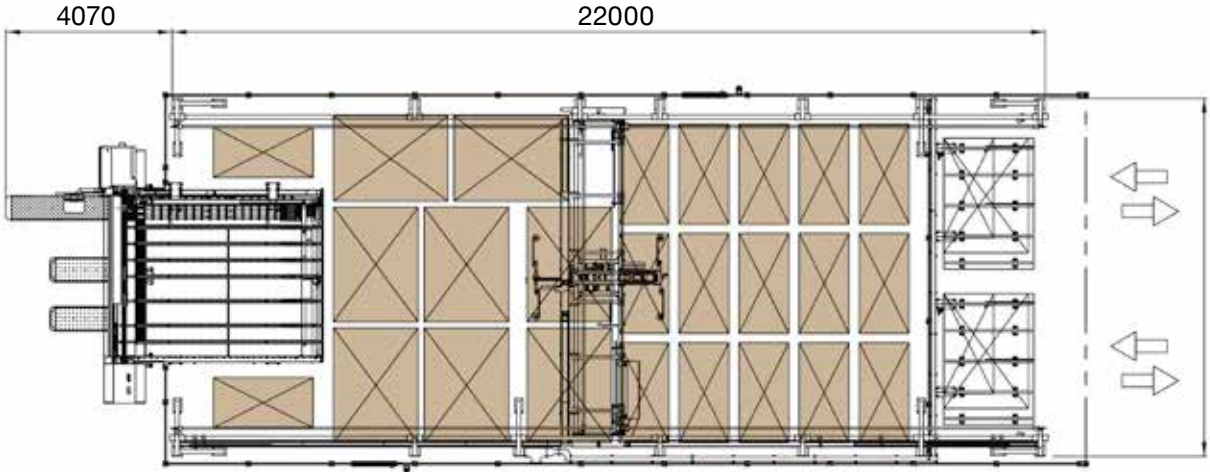

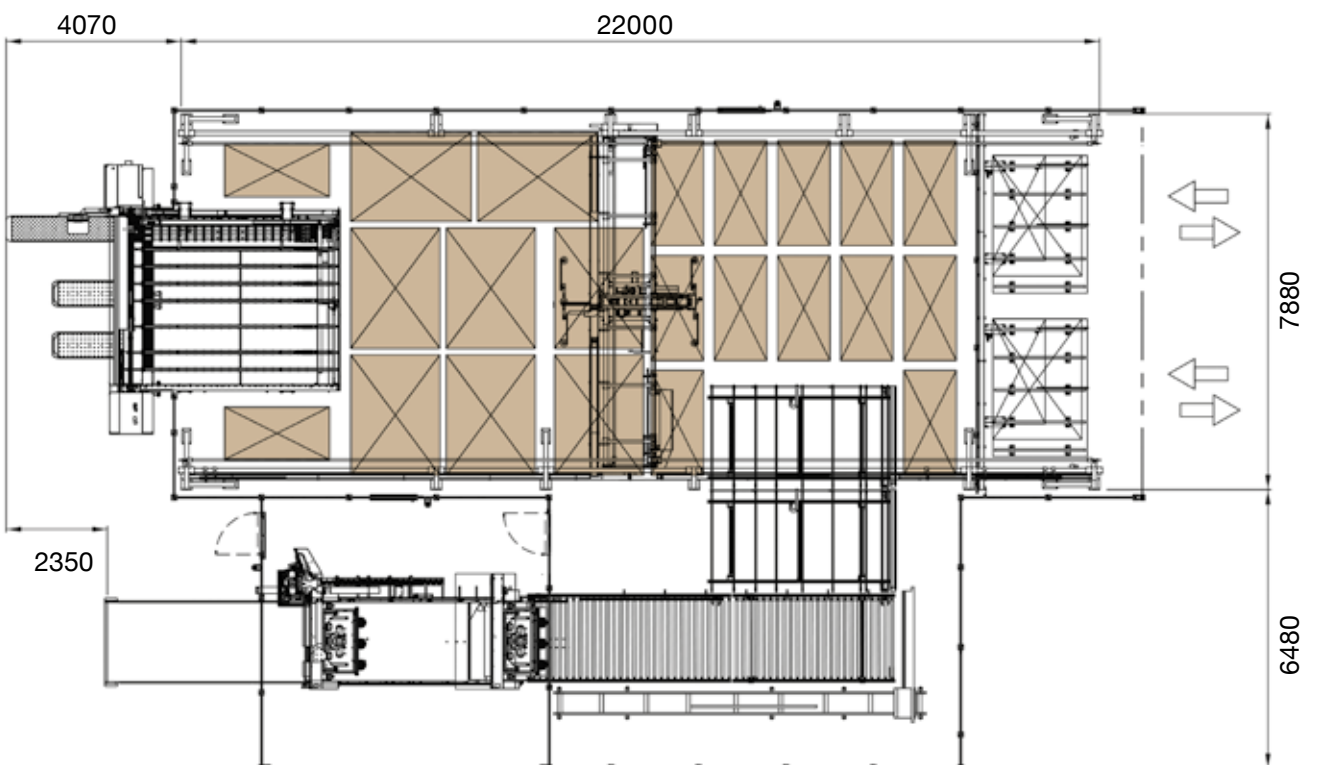
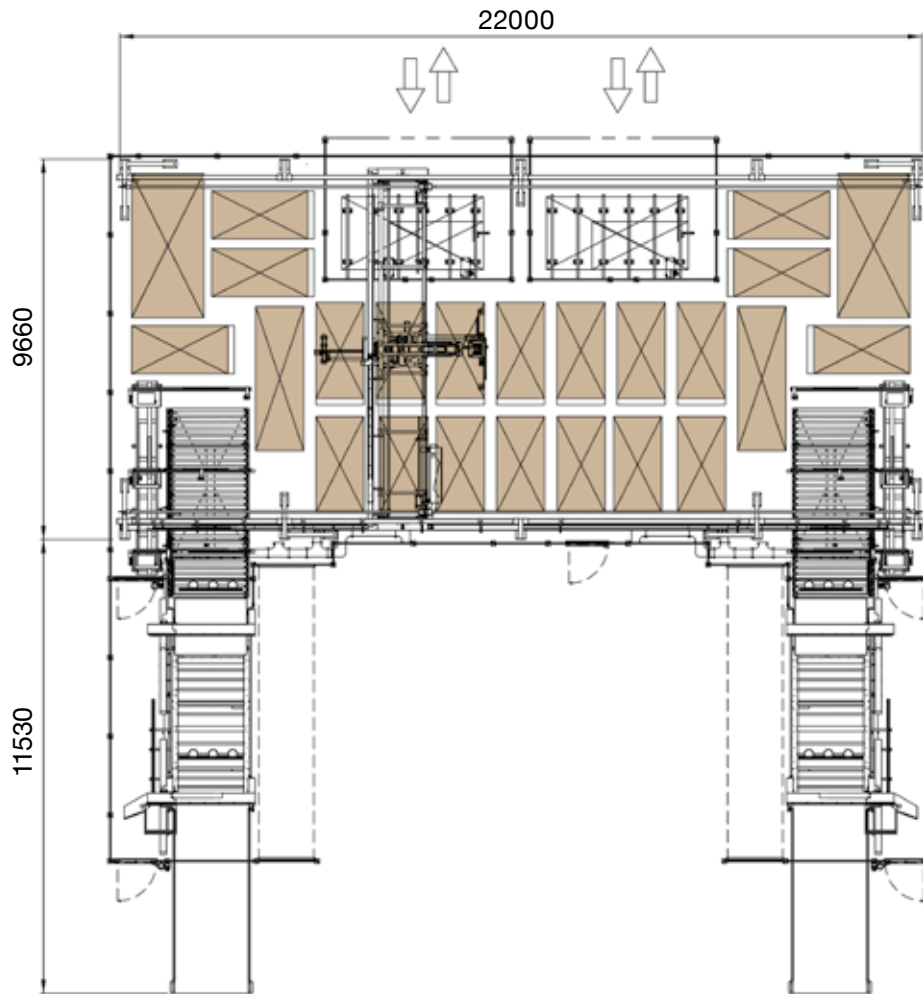

flexstore hp

the solution for all requirements

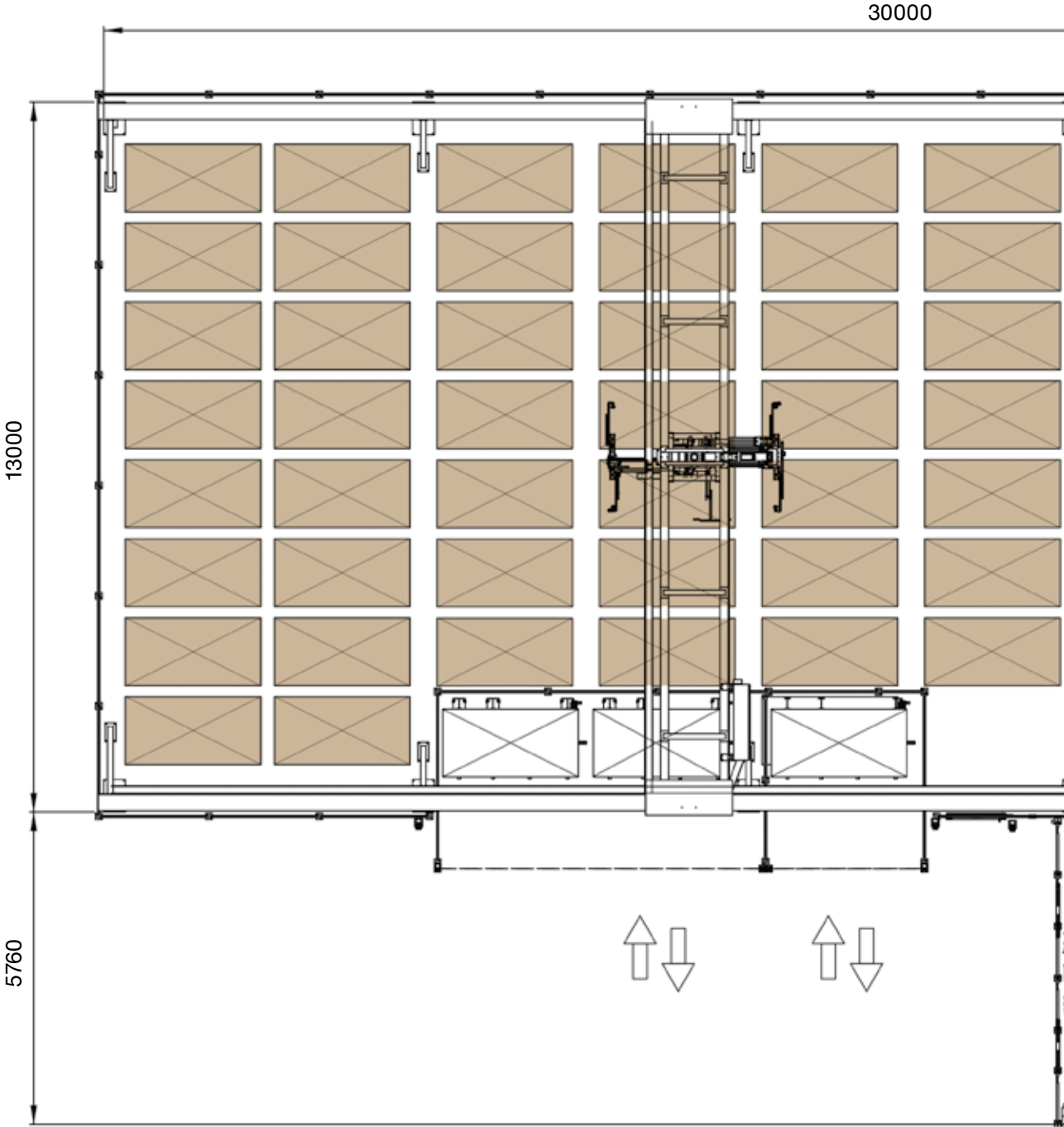

* measurements provided by way of example only - not binding

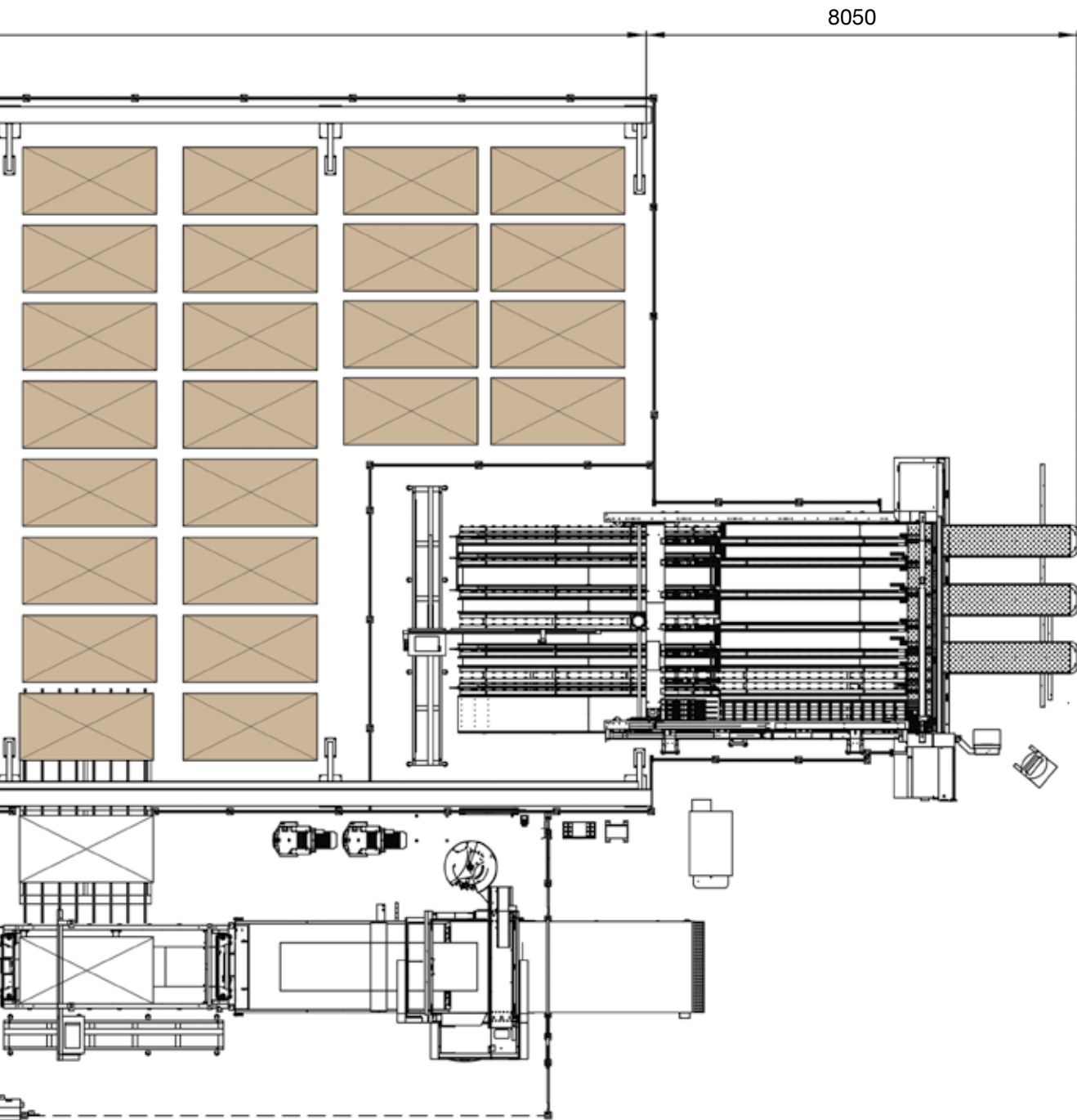

software



WatchStore is the software developed completely by SCM for **managing the storage system and cell**. It can be integrated with client company management software and with the machines to provide the best solution for production and storage management and organisation.

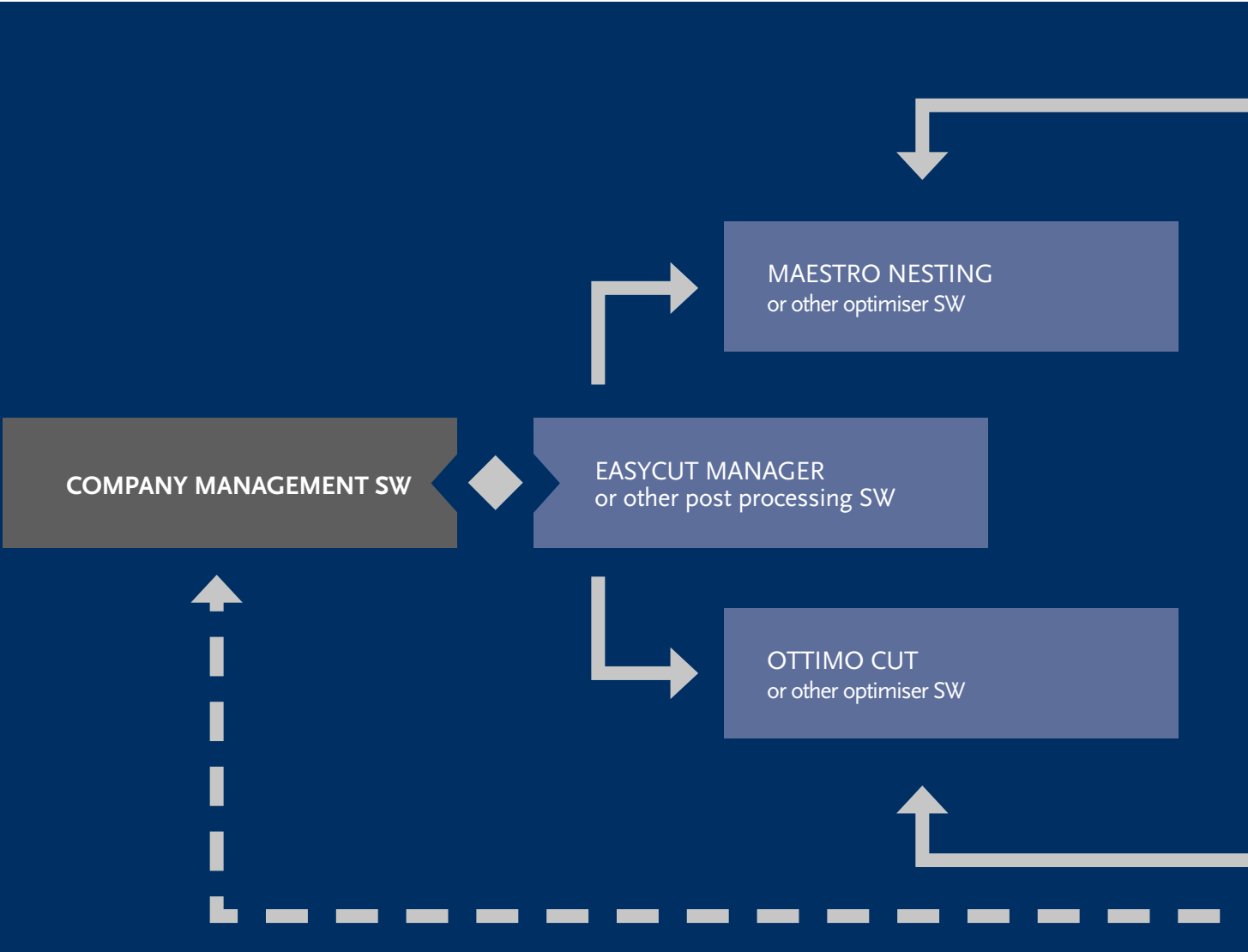

Main features:

- 1 Fully configurable software for management of materials, areas, alarms.
- 2 Complete cell management and integration with the machines.
- 3 User-friendly thanks to a single front end.
- 4 Management of external storage systems, material remaining after machining and materials outside the storage area.
- 5 Materials management using bar codes.
- 6 Generation of production reports.

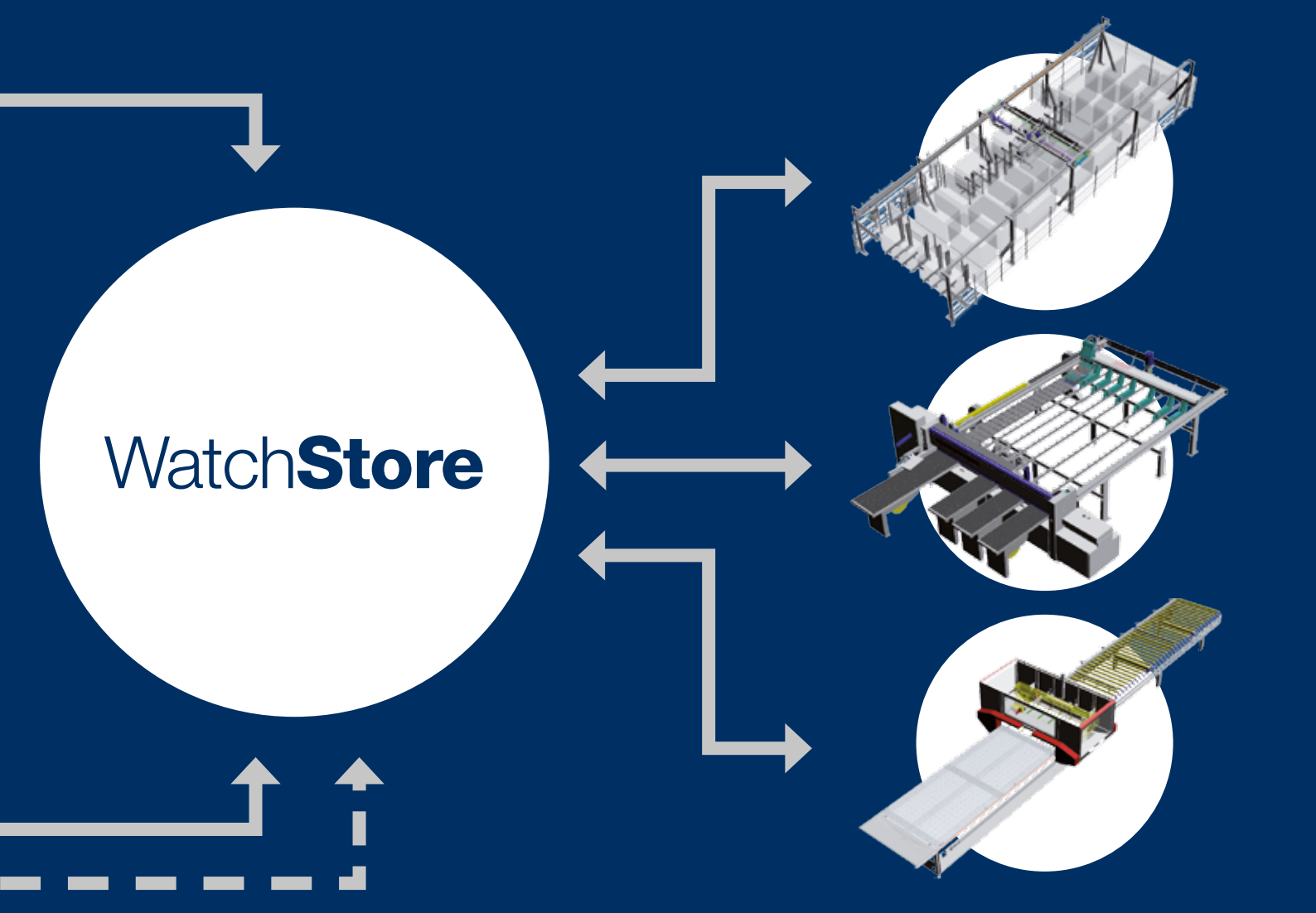

REDUCED CONSUMPTIONS = REDUCED COSTS
 Savenergy allows the use of **energy only when it is needed**, making devices work only when really necessary. The machine automatically goes into stand-by mode when there are no panels to be machined. Annual saving of up to 10% (opt.).

IMPROVED PRODUCTION FLOW FOR BETTER ENERGY EFFICIENCY.
 Thanks to the functions of the Flexstore Storage Systems, use of the machines is optimised, making the most of them in terms of both productivity and energy saving.

THE STRONGEST WOOD ARE IN OUR DNA

SCM. A HERITAGE OF SKILLS IN A UNIQUE BRAND

Over 65 years of success gives SCM the centre stage in woodworking technology. This heritage results from bringing together the best know-how in machining and systems for wood-based manufacturing. SCM is present all over the world, brought to you by the widest distribution network in the industry.

65 years history

3 main production sites in Italy

300.000 square metres of production space

17.000 machines manufactured per year

90% export

20 foreign branches

350 agents and dealers

500 support technicians

500 registered patents

In SCM's DNA also strength and solidity of a great Group. The SCM Group is a world leader, manufacturing industrial

SCM GROUP, A HIGHLY SKILLED TEAM EXPERT IN INDUSTRIAL

INDUSTRIAL MACHINERY

Stand-alone machines, integrated systems and services dedicated to processing a wide range of materials.



WOODWORKING TECHNOLOGIES



TECHNOLOGIES FOR PROCESSING
COMPOSITE MATERIALS, ALUMINIUM,
PLASTIC, GLASS, STONE, METAL



The technical data can vary according to the requested machine composition. In this catalogue, machines are shown with options. The company reserves the right to modify technical specifications without prior notice; the modifications do not influence the safety foreseen by the CE Norms.

TECHNOLOGIES



equipment and components for machining the widest range of materials.

MACHINES AND COMPONENTS

INDUSTRIAL COMPONENTS

Technological components for the Group's machines and systems, for those of third-parties and the machinery industry.

HITECO

SPINDLES AND TECHNOLOGICAL
COMPONENTS

Les

ELECTRIC PANELS

steelmec

METALWORK

scmfonderie

CAST IRON



SCM GROUP SPA

via Casale 450 - 47826 Villa Verucchio, Rimini - Italy
tel. +39 0541 674111 - fax +39 0541 674274
scm@scmgroup.com
www.scmwood.com



00L0365618D