

morbidelli p800

multifunctional machining centre for panel drilling routing and edge-banding



morbidelli p800

Designing and building solutions to your requirements is in our DNA

You can customise your **morbidelli p800** to create an even better working experience. All accessories are designed to increase productivity and to be as easy as possible to use in all conditions.

- **ZERO SET-UP TIME**

when switching from one machining operation to the next with the NC worktable featuring a workpiece **automatic separation** software function. This means that you can machine **more panels with a single loading operation**, ideal for increasing productivity.

- **ZERO DEFECTS**

with maximum absolute quality even for joins on “difficult” workpieces. The new “SBRINDLE” device reads the position of the edging “on-the-fly”.

- **ZERO DIFFICULTY**

programming, even for less experienced operators, using **MAESTRO EDGE** the brand new software with which a single platform is used to carry out all types of machining.

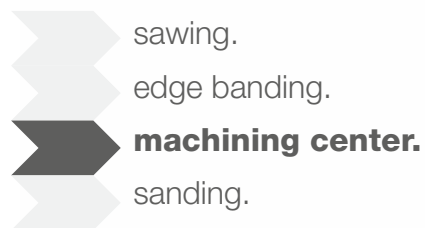



morbidelli p800

Zero set-up time, between one machining operation and the next

LARGE WORKTABLE

the machine can be fitted with:

START WORKTABLE with manually moved bars and suction cups and a display function on the remote control.

MATIC WORKTABLE with bars and suction cups moved automatically and simultaneously with anti-collision control, for super-fast set-ups (4 -5 seconds). On both the **MATIC** and **START** worktables all stops are managed by the program depending on the type of machining and are equipped with sensors that detect when they have been excluded.



Wide choice of equipment for machining with mechanical hold-downs. Suction cups can easily be removed from the supports, leaving the operator great freedom to adapt the machining area to the shape of the panel. Workpiece hold-down is guaranteed not just by a vacuum, but also by suction cup mechanical locking.

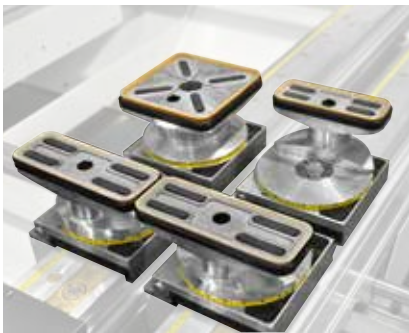

A vast range of suction cups guarantees the best solution for perfect panel locking.

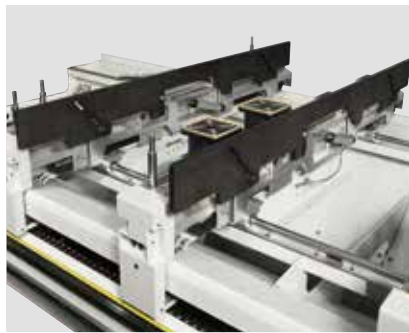

Loading aid devices fitted with sensors and with pneumatic lifting make heavy panel positioning on the worktable easy.



and maximum product and factory cleanliness



Collecting belt for carrying away machining waste and shavings.



Shavings conveyor PLATE, for optimum cleanliness in the machining area.



Optimised centralised suction reduces consumption and maximises performance.

morbidelli p800

Zero defects from production, with absolute quality even for joins on “difficult” workpieces



The new edge banding unit with glue application directly on the edging **reduces the number of mechanical parts** needed to build it with a consequent increase in:

- flexible use on complex profiles thanks to the reduced overall dimensions
- total reliability of the gluing process because it is simpler.

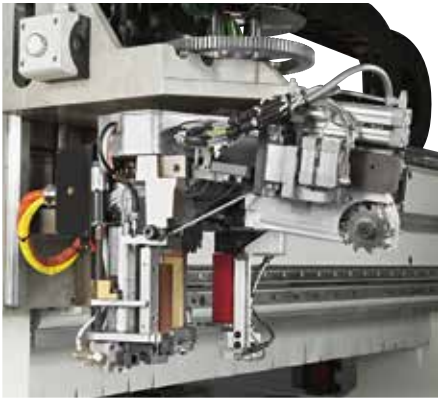

A higher performance edge banding unit that allows the application of edging **up to 84 mm high** for panels **up to 80 mm thick**. The new “SBRINDLE” device can detect the position of the start of the edging on-the-fly”, allowing $0/360^\circ$ joins on minimum stretches



The **numerically controlled Z axis** allows adjustment of the lower projection of the edging relative to the worktable, for example for using dust seal edging.

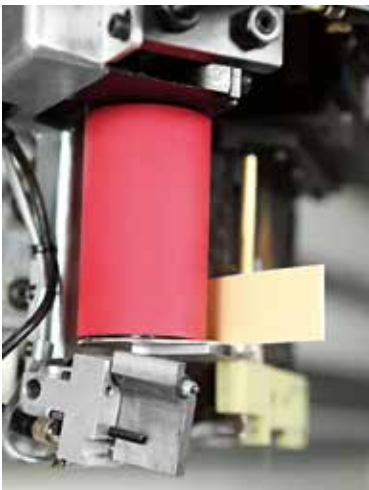

Optimises the cycle time in edge banding operations with $0/360^\circ$ join. The join can be made on stretches with constant geometry having a **minimum length of 80 mm**.

The edging magazine can hold **from 2 to 12 different types of edging** so that it can always make available the one best suited to the machining set. Selection, feeding and supply speed are managed by the numeric control.



and maximum hold from gluing

Automatic adjustment of the edging vertical limiters allows maximum machining flexibility, working in rapid succession on panels with different thicknesses, particularly effective for batch 1 production.



The quick change glue tank has a unique design with a **spreading roller featuring a built-in heating element** to guarantee uniform gluing and lasting adhesive chemical properties for the best possible product performance. Fast change-overs allow preventive maintenance or a change of glue (colour or type), slashing down times.



Glue is loaded in masked times into the granule feed system fixed to the gluing unit.

morbidelli p800

Zero finishing problems with powerful routing units

The high-tech 5-axis machining unit with 17 kW (S6) power rating can machine workpieces with complex geometric shapes, guaranteeing quality and precision. C axis, continuous 0/360° and pneumatic devices for edging finishing heads.



The 4-axis machining unit with 11 and 15 kW (S6) power ratings, mounted on a carriage independent from the boring unit, can perform all vertical routing functions using edging finishing heads. C axis continuous 0/360° and pneumatic devices for edging finishing heads.



Tool substitution is automatic and takes place in masked times, while the edge banding unit is operating. This is possible thanks to the 10 and 18 location tool magazines installed directly on the machine.

and flexibility, with the possibility of configuring the machine with different boring units



Blade unit integrated with the boring head, with 0-90° rotation for back cutting without changing tool.

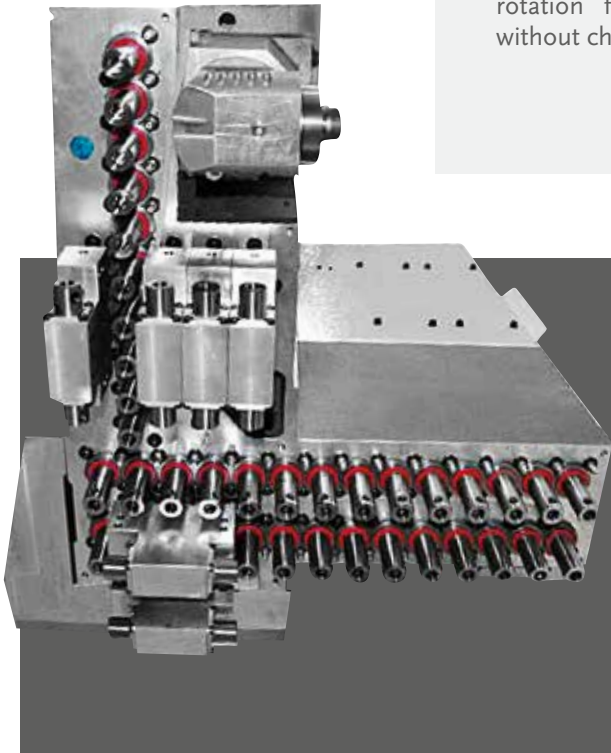

Possibility of configuring the machine with different boring units with independent spindles, for a boring capacity that meets your requirements. The latest-generation ultra-rigid boring heads with RO.AX (Rotoaxial spindle technology) can be installed. They operate at 8000 rpm, with from 26 spindles up to a powerful head with 50 independent spindles. For heavy duty boring (sides of wardrobes, soundproofing panels, etc.) or for very diverse bit types and diameters.



3-axis electro-spindle, excellent for shaping panels or for anti-splinter machining on panels already edged, **avoiding a tool change on the main motor.**



Blade unit with 0-360° independent rotation, ideal for panel sizing or **edging end trimming on-the-fly.**



PB1
PB1_ 3-axis electro-spindle with 6 location on-board tool changer. The definitive solution for the most diverse machining operations, guaranteeing **machining continuity** alternating with the main motor.

morbidelli p800

machining units

finishing heads and aggregates

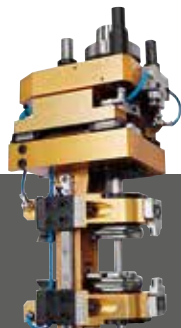

Multifunction trimmer + edge scraper unit



Blade unit for edging end trimming

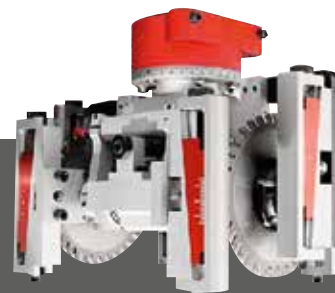

Rounding end trimming unit



Head for cleaning 90° internal angles (doors, kitchen tops, etc.)



Head for postformed panels



Head for routing on lower face

Edge trimming processing on wooden edge



Edging trimming.

Edge scraping.

Zero risks for the operator, who can always work in complete safety

Pressure mats let the machine operate at a constant top speed and guarantee total operator safety.



Overlapping layers of side safety slats protect the machining unit, able to move for completely safe top speed machining.



Maximum machining visibility.



The remote console gives the operator direct, immediate control

morbidelli p800

Zero difficulty programming, even for less experienced operators

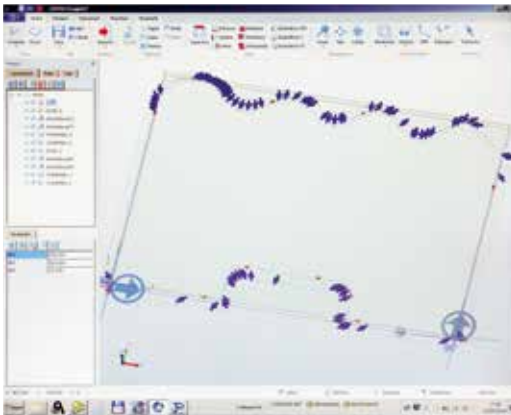

MAESTRO EDGE

The brand new 3D software with which a single platform is used to carry out all types of machining. Developed for morbidelli p800, it even allows less expert operators to **very quickly create, edit and manage edge banding programs**.

A long list of functions for 360 degree panel machining includes **all features and performance for easy, intuitive and effective programming**.

EDGEMANAGER

The software module ideal for working with a wide variety of edging strips.

A database of technical information that is always available and can be imported directly into machining programs to **start production in zero time**.

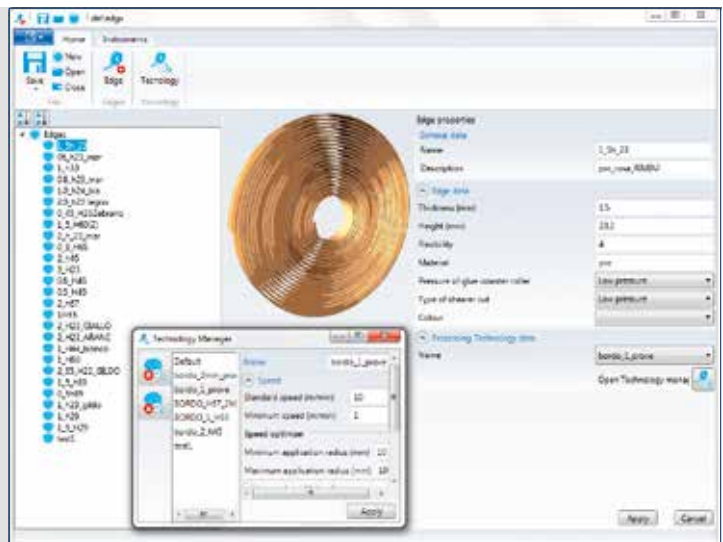

You can see a preview of the workpiece and benefit from easy design guidance:

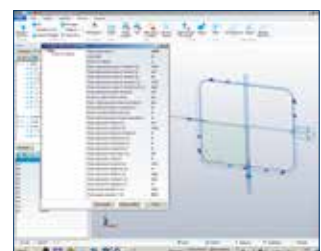
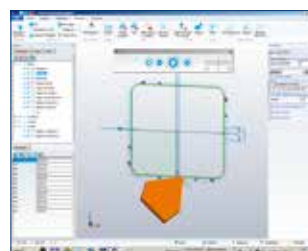
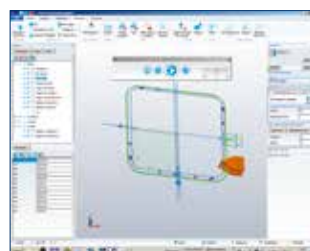
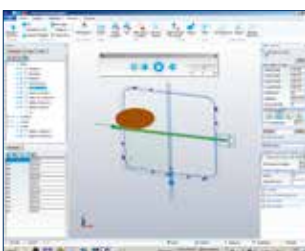
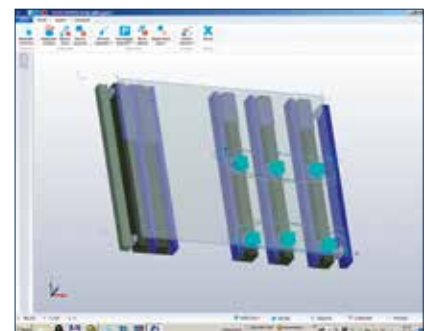
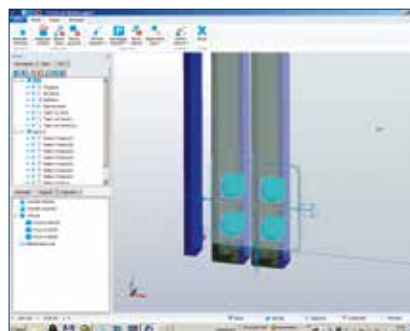
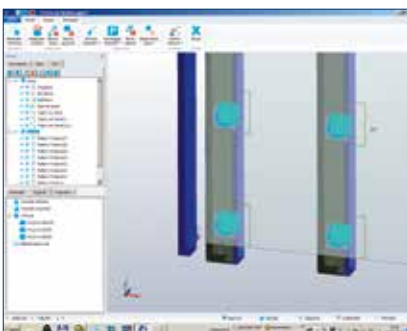

morbidelli p800

TECHNICAL DETAILS

MORBIDELLI P800

technical details

Machining area in X	mm	5020 - 6360
Machining area in Y	mm	1680 - 1830
Panel passage *	mm	80/220 with H110
Edging thickness	mm	0.5 - 3.0
Edging height	mm	15/84
Minimum internal radius for 90° angle **	mm	30
Minimum external radius for 90° angle **	mm	10
Edging magazine capacity	No.	2 Standard - 6 optional
5-axis electro-spindle power	kW	17
4-axis electro-spindle power	kW	11 - 15
Electro-spindle tool fitting		HSK63F
Rapid tool magazine capacity		18 (std) - 10 on board (opt)
Boring bits motor	kW	2,2
Boring bits revolutions	RPM	8000
Z1 axis stroke	mm	600
Z2 axis stroke		325
Movement speed in X	m/min	90
Movement speed in Y	m/min	90
Movement speed in Z	m/min	30
Installed power	kW	25/35
Compressed air pressure	bar	7
Electro-spindle extractor duct diameter	mm	250
Boring head extractor duct diameter	mm	100
Extraction air consumption	m ³ /h	5700
Total weight	kg	8000/10000

* The maximum thickness that can be machined depends on the thickness of the workpiece, the length of the tool used and the type of edging.

** The internal and external radii depend on the thickness and type of edging.

MORBIDELLI P800

layout

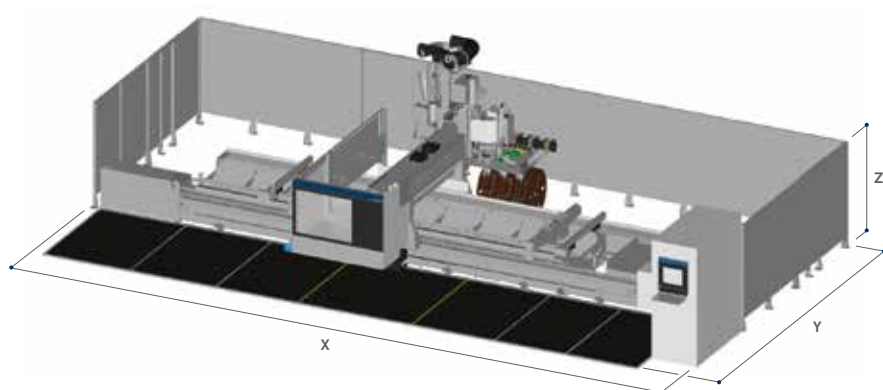

Machining Area		Overall Dimensions (mm)		
X	Y	X	Y	Z
5020	1680	11425	5045	3000
5020	1905	11425	5275	3000
6360	1680	12765	5045	3000
6360	1905	12765	5275	3000

THE STRONGEST WOOD ARE IN OUR DNA

SCM. A HERITAGE OF SKILLS IN A UNIQUE BRAND

Over 65 years of success gives SCM the centre stage in woodworking technology. This heritage results from bringing together the best know-how in machining and systems for wood-based manufacturing. SCM is present all over the world, brought to you by the widest distribution network in the industry.

65 years history

3 main production sites in Italy

300.000 square metres of production space

17.000 machines manufactured per year

90% export

20 foreign branches

350 agents and dealers

500 support technicians

500 registered patents

In SCM's DNA also strength and solidity of a great Group. The SCM Group is a world leader, manufacturing industrial

SCM GROUP, A HIGHLY SKILLED TEAM EXPERT IN INDUSTRIAL

INDUSTRIAL MACHINERY

Stand-alone machines, integrated systems and services dedicated to processing a wide range of materials.



WOODWORKING TECHNOLOGIES



TECHNOLOGIES FOR PROCESSING
COMPOSITE MATERIALS, ALUMINIUM,
PLASTIC, GLASS, STONE, METAL



The technical data can vary according to the requested machine composition. In this catalogue, machines are shown with options. The company reserves the right to modify technical specifications without prior notice; the modifications do not influence the safety foreseen by the CE Norms.

TECHNOLOGIES



equipment and components for machining the widest range of materials.

MACHINES AND COMPONENTS

INDUSTRIAL COMPONENTS

Technological components for the Group's machines and systems, for those of third-parties and the machinery industry.

HITECO

SPINDLES AND TECHNOLOGICAL
COMPONENTS

Les

ELECTRIC PANELS

steelmec

METALWORK

scmfonderie

CAST IRON



SCM GROUP SPA

via Casale 450 - 47826 Villa Verucchio, Rimini - Italy
tel. +39 0541 674111 - fax +39 0541 674274
morbidelli@scmgroup.com
www.scmwood.com



00L0367224L