



bSolid

MAKES IT REAL

Your dreams will come true



 **BIESSE**

DESIGNING

PROGETTARE CON BSOLID È SEMPLICE ED INTUITIVO

Il software permette anche ad utenti meno esperti di accedere a funzionalità sofisticate: dall'idea direttamente alla progettazione visuale del "pezzo".

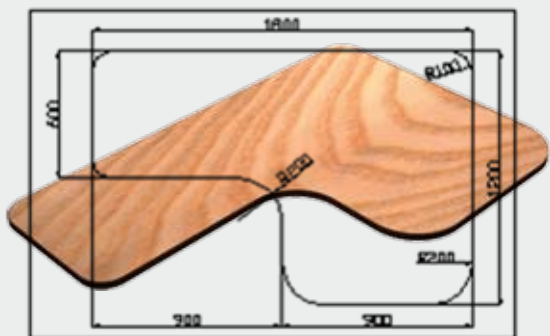

DESIGN WITH BSOLID IS EASY AND FRIENDLY

The software allows any user to access sophisticated features: from an idea directly to the visual designing of the "part".

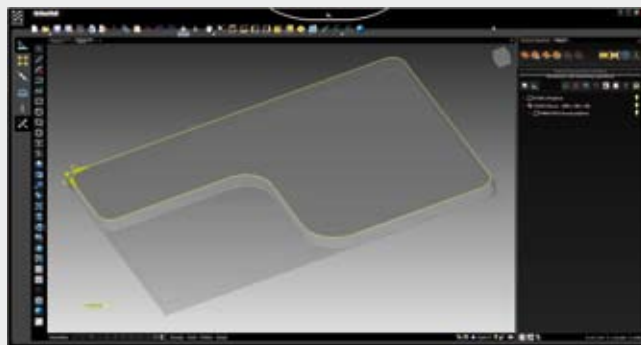

EINFACHES UND INTUITIVES GESTALTEN MIT BSOLID

Die Software erlaubt allen Anwendern mit anspruchsvollen Funktionen zu arbeiten: vom Konzept direkt zur visuellen Gestaltung des Werkstücks.

È proprio questa la forza di bSolid. Passare da un concetto alla sua progettazione visuale in pochi click.

This is the strength of bSolid. Going from a concept to its visual designing in a few clicks.

Genau das ist die Stärke von bSolid. Mit wenigen ‚Klicks‘ vom Konzept zum visuellen Entwurf des Modells.

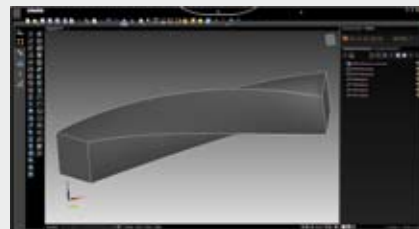
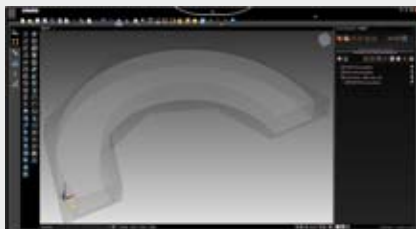
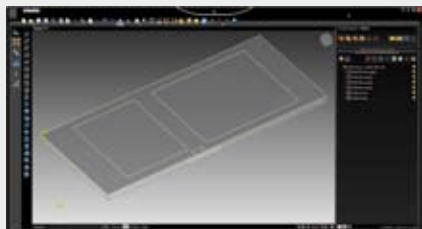

Sono presenti funzionalità pronte ad aiutarti nel lavoro di tutti i giorni. Puoi passare dai tuoi disegni alla realizzazione di un intero programma premendo un solo tasto.

Features readily available to help you in your daily task. Convert your drawing to a machining program by the click of a button.

Sie finden Funktionen, die Ihre tägliche Arbeit erleichtern. Konvertieren Sie Ihre Zeichnungen mit einem Klick in Maschinenprogramme.

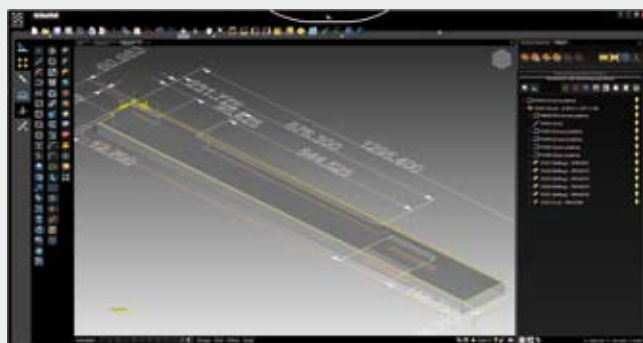
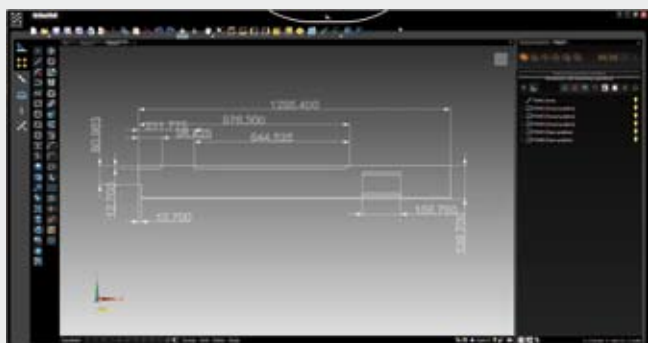

■ Grazie all'integrazione di un nuovo sistema di apprendimento, bSolid ti aiuta a trasformare qualsiasi cosa in realtà.

■ The integrated new learning system allows bSolid to transform your imagination into reality.

■ Dank der Integration eines neuen Lernsystems, hilft Ihnen bSolid jede Idee zu verwirklichen.

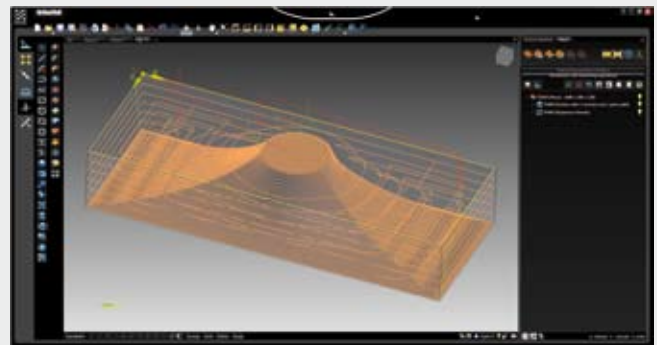
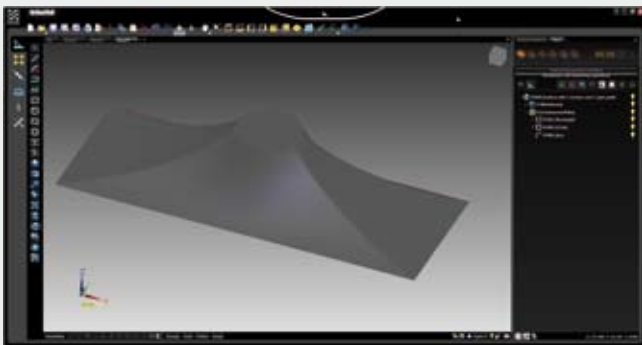

■ Tramite la disponibilità di un cad integrato di ultima generazione, puoi usare bSolid come unico sistema di progettazione.

■ Thanks to a fully integrated latest generation cad, you can use bSolid as a unique design system.

■ Dank des integrierten CAD-Programms der neuesten Generation, können Sie bSolid als einziges Entwicklungssystem nutzen.

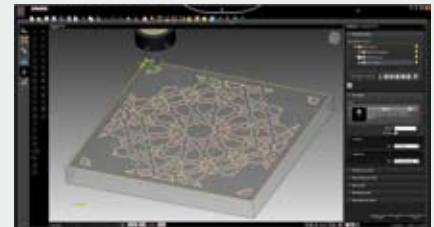
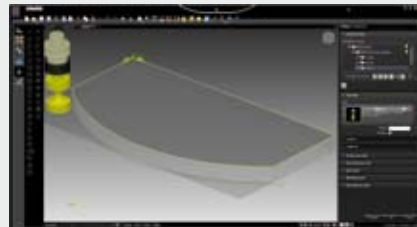
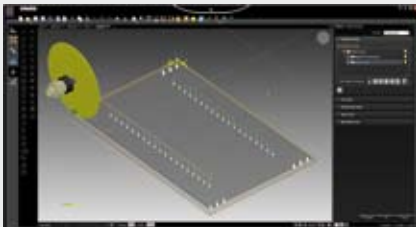

■ Puoi passare dalla programmazione di base a realizzazioni molto complesse, con un unico sistema semplice ed efficace.

■ Go from a basic program to complex design, with a unique system easily and smartly

■ Ein einfaches und effektives System führt Sie von der Grundprogrammierung zu komplexen Entwürfen.

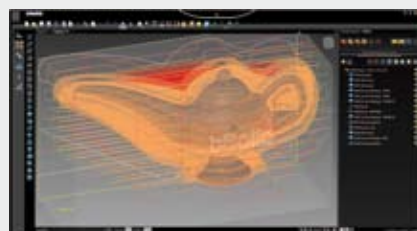
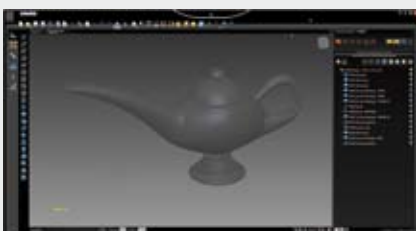

SIMULATING

COSTRUISCI E SIMULA CON BSOLID

Con la gestione 3D degli utensili, è semplice verificare il risultato del tuo progetto attraverso una simulazione rapida ed efficace.

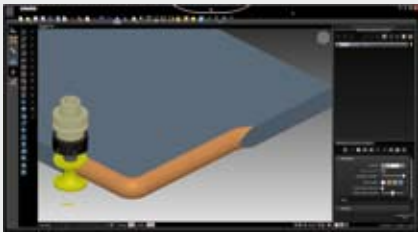
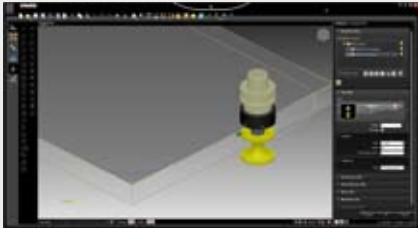

BUILD AND SIMULATE WITH BSOLID

The 3d tools management quickly and easily verifies your design results through a rapid real-time simulation.

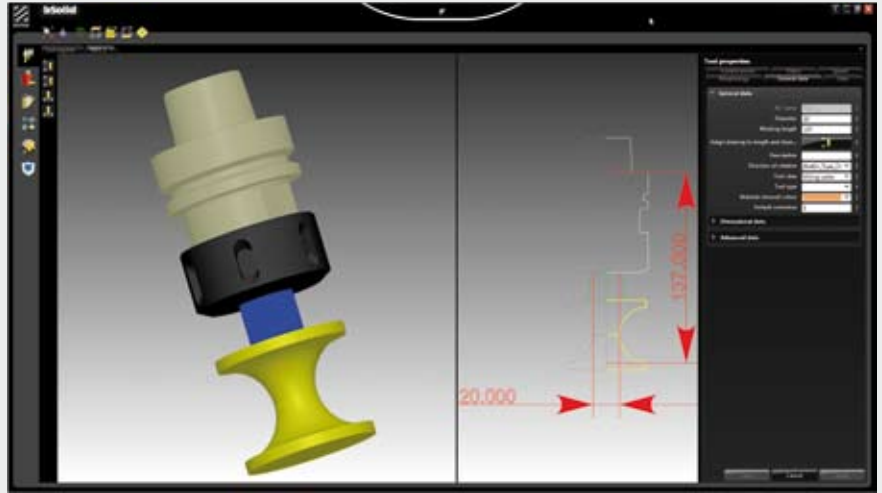

KONSTRUIEREN UND SIMULIEREN MIT BSOLID

Dank der 3D-Werkzeug-Verwaltung ist es sehr einfach, das Ergebnis Ihres Projektes durch schnelle und realistische Simulation zu prüfen.

Costruisci i tuoi utensili in modo semplice e intuitivo.

Da una semplice fresa cilindrica a utensili multi profilo, in maniera visuale e parametrica.

Build your tooling quickly and easily.

From a simple straight bit to a multi profile tool, easily produced utilising visual and parametric features.

Konstruieren Sie einfach und schnell Ihre eigenen Werkzeuge.

Von einem geraden Schaft bis hin zu mehrfach profilierten Werkzeugen, einfach, visuell und parametrisch.

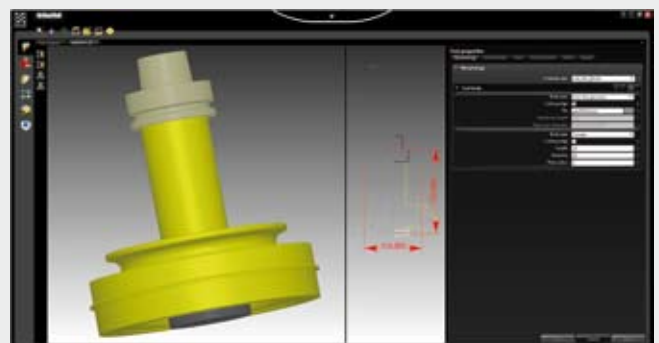
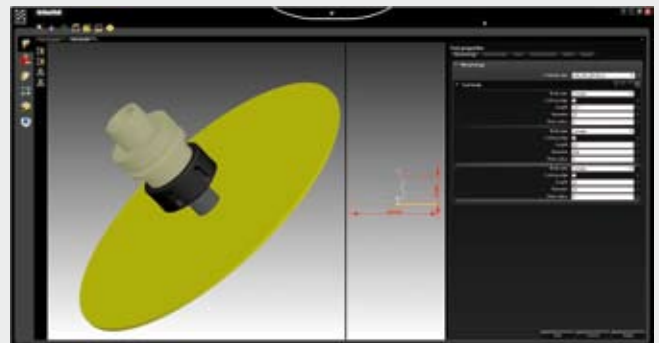
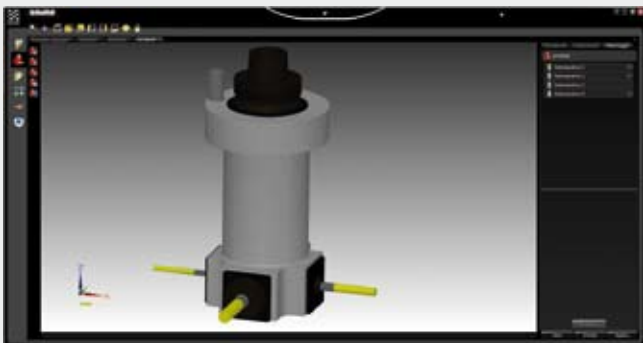

La simulazione diretta e visuale disponibile in bSolid ti permette di:

- verificare l'effettiva correttezza dei percorsi utensile;
- prevenire banali errori di programmazione (profondità di lavoro, approcci al materiale, sequenza utensili etc);
- manipolare, misurare e modificare la realizzazione del tuo progetto;
- eseguire verifiche o manipolazioni sul progetto ancora prima di eseguirlo sulle tue macchine.

The visual and direct simulation available on bSolid allows you to:

- verify the correct data used regarding tool paths;
- prevent trivial programming errors (such as depth, lead-in, working sequence etc.);
- manipulate , measure and modify the realizing of the finished part;
- perform checks and manipulation on the project way before executing it on your machine.

Die direkte und realistische Simulation von bSolid erlaubt:

- das Prüfen der Werkzeugwege;
- einfache Programmierfehler (an Bearbeitungstiefen, Anfahrbewegungen, Programmabläufen, usw.) zu vermeiden;
- die Herstellung Ihrer Werkstücke zu steuern, zu messen und zu verändern;
- das Projekt zu prüfen und zu ändern, bevor es auf Ihren Maschinen hergestellt wird.

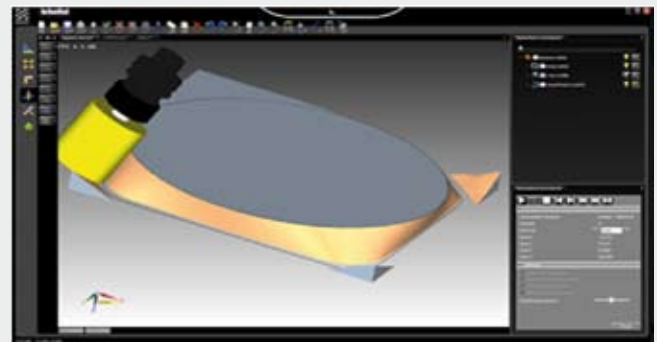
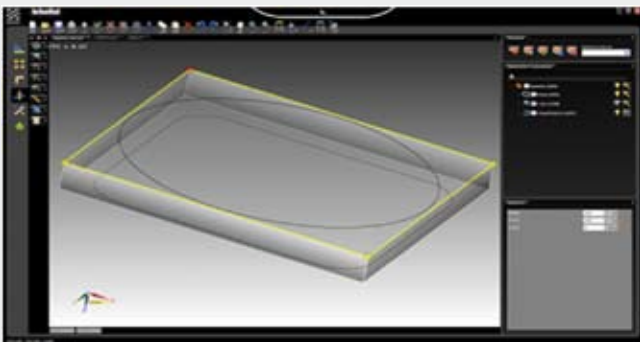
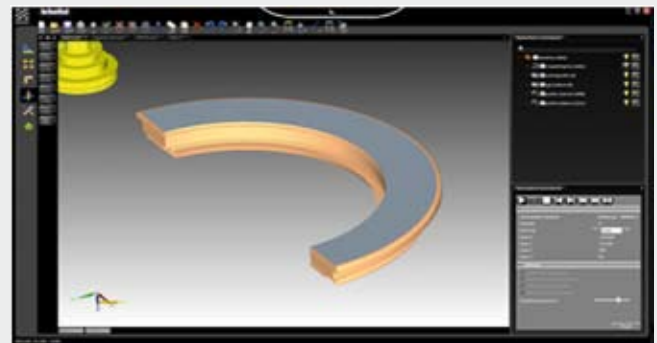
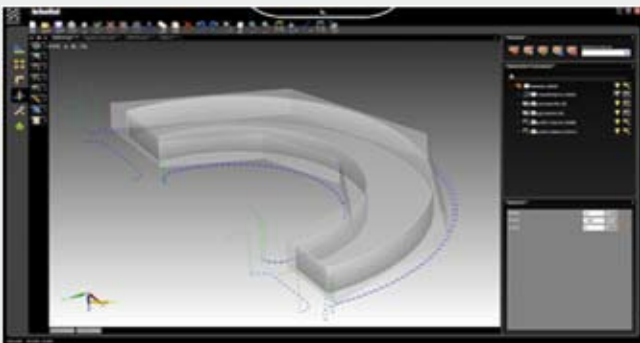
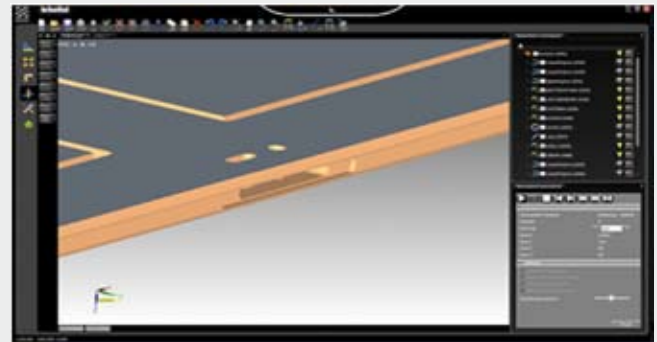
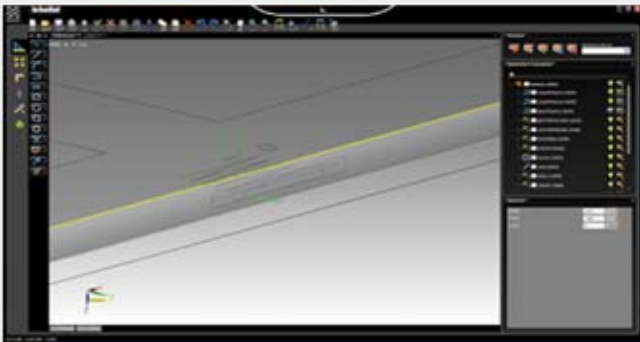

REALIZING

REALIZZA I TUOI PROGETTI SULLA MACCHINA VIRTUALE E RISPARMIA TEMPO

bSolid rende disponibili le tue macchine in un ambiente virtuale, grazie alla totale integrazione di:

- componenti 3D di tutta la macchina;
- cinematiche di movimentazione assi;
- gestione magazzini e utensili;
- integrazione diretta con il controllo numerico.

REALIZE YOUR PROJECTS ON THE VIRTUAL MACHINE AND SAVE TIME

bSolid makes available your machines in a virtual environment, thanks to a full integration of:

- 3D solid models and all the machine components;
- Kinematic axis motion;
- tools and tool-holders management;
- Numerical control integration.

BEARBEITEN SIE IHRE PROJEKTE AUF DER VIRTUELLEN MASCHINE UND SPAREN SIE ZEIT

bSolid stellt Ihnen die Maschinen in einer virtuellen Arbeitsumgebung zur Verfügung, dank der Integration von:

- 3D Komponenten der gesamten Maschine;
- Kinematik der Achsenbewegung;
- Management der Werkzeuge und des Werkzeugmagazins;
- Integration der numerischen Steuerung.

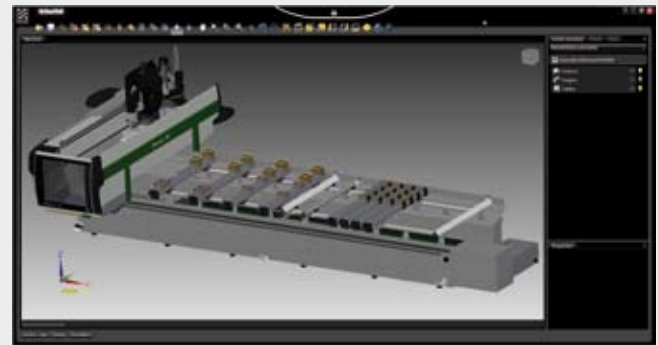
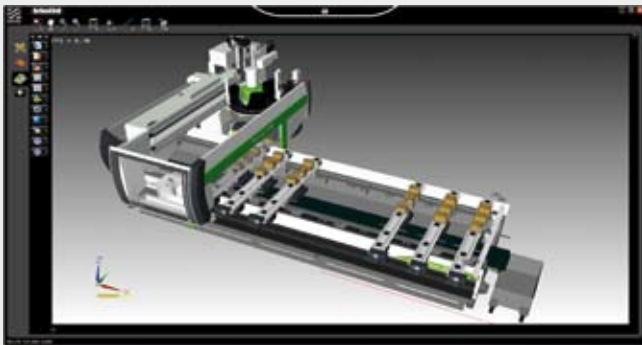

Puoi eseguire virtualmente tutte quelle fasi fino ad oggi esclusive del reale uso della macchina:

- configurazione magazzini utensile;
- verifica visuale interferenze;
- attrezzaggio mandrini.

With bSolid it is now possible to virtually execute all those steps that until now were exclusive until the final machining:

- tools storing configuration;
- visual check interference;
- spindle equipment.

Mit bSolid ist es jetzt möglich die Schritte virtuell auszuführen, die bisher nur auf der Maschine realisiert werden konnten:

- Konfiguration des Werkzeugmagazins;
- Visuelle Prüfung auf Kollisionen;
- Spindelaustrüstung.

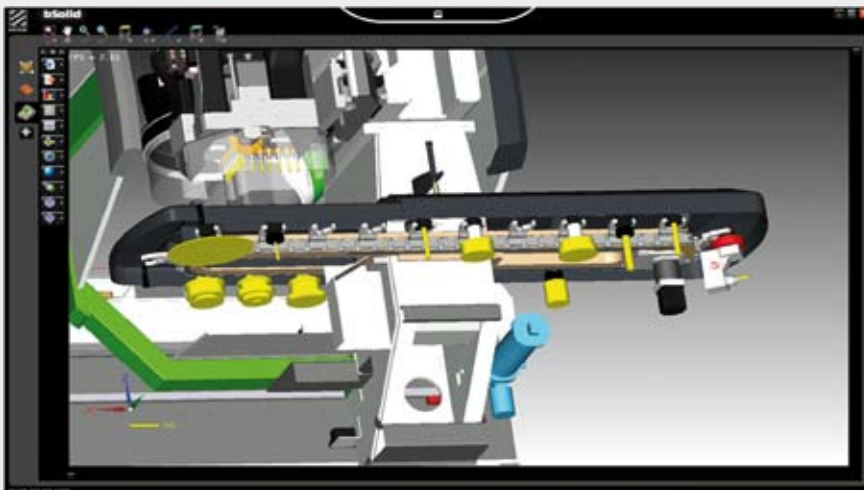

■ Calcolo automatico per il posizionamento di piani e carrelli:

- movimentazione reale;
- profilatura del pezzo;
- calcolo reale del tempo necessario alla lavorazione;

■ Automatic calculation for work table and support position:

- real axis motion;
- material removal;
- real time study calculation;

■ Automatische Berechnung der Positionen von beweglichen Spannvorrichtungen:

- realistische Achsenbewegungen;
- Materialabtrag am Werkstück;
- realistische Berechnung der Bearbeitungszeit;



- controllo dinamico delle collisioni;
- ambiente in real time che permette di intervenire in ogni momento su qualsiasi organo macchina.

- collision prevention;
- real time environment that allows to set any movable components even during the simulation.

- dynamische Kollisionskontrolle;
- Real-Time Betriebsumgebung, welche ermöglicht, alle beweglichen Komponenten auch während des Betriebs der Maschine einzustellen.

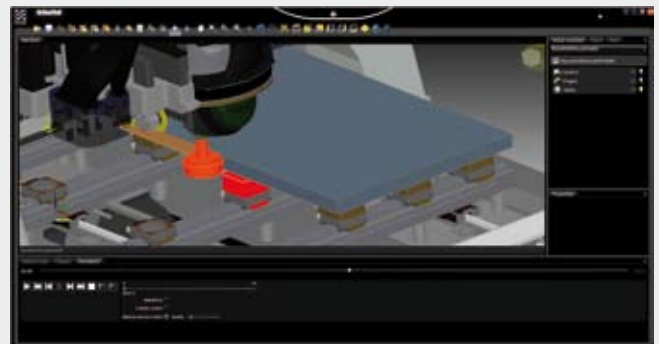

■ Con bSolid è possibile progettare, simulare e realizzare in un modo che non pensavi possibile.

■ With bSolid it is possible to design, simulate and realize in a way you didn't think possible.

■ Mit bSolid können Sie auf eine Weise entwerfen, simulieren und realisieren, die Sie für unmöglich hielten.



Biesse in the World



Printed on FSC certified paper

www.biesse.com

5808A0587 bSolid I-E-D 04 - 2013

BIESSE BRIANZA

Alzate Brianza (Como), Italy
Tel. +39 031 630773_Fax +39 031 632298
brianza.commerciale@biesse.com - www.biesse.com

BIESSE TRIVENETO

Codogné (Treviso), Italy
Tel. +39 0438 793711_Fax +39 0438 795722
triveneto.commerciale@biesse.com - www.biesse.com

BIESSE DEUTSCHLAND GMBH

Elchingen, Germany
Tel. +49 (0)7308 96060_Fax +49 (0)7308 960666
Loehne, Germany
Tel. +49 (0)5731 744870_Fax +49 (0)5731 744 8711
info@biesse.de - www.biesse.de

BIESSE FRANCE

Brignais, France
Tèl. +33 (0)4 78 96 73 29_Fax +33 (0)4 78 96 73 30
commercial@biessefrance.fr - www.biessefrance.fr

BIESSE IBERICA WOODWORKING MACHINERY SL

Gavà, Barcelona, Spain
+34 (0)93 2631000_Fax +34 (0)93 2633802
biesse@biesse.es - www.biesse.es

BIESSE GROUP UK LTD.

Daventry, Northants, United Kingdom
Tel. +44 1327 300366_Fax +44 1327 705150
info@biesse.co.uk - www.biesse.co.uk

BIESSE SCANDINAVIA

Representative Office of Biesse S.p.A.
Jönköping, Sweden
Tel. +46 (0)36 150380_Fax +46 (0)36 150380
biesse.scandinavia@telia.com
Spare parts:
Lindås, Sweden
Tel. +46 (0)471 25170_Fax +46 (0)471 25107
spareparts@biesse.se - www.biesse.com

BIESSE AMERICA

Charlotte, North Carolina, USA
Tel. +1 877 8 BIESSE
Fax +1 704 357 3130
sales@biesseamerica.com - www.biesseamerica.com

BIESSE ASIA PTE. LTD.

Singapore
Tel. +65 6368 2632_Fax +65 6368 1969
mail@biesse-asia.com.sg

BIESSE CANADA

Headquarters & Showroom: Mirabel, QC, Canada
Sales Office & Showroom: Toronto, ON, Canada
Showroom: Vancouver, BC, Canada
Tel. +1 800 598 3202
Fax +1 450 437 2859
sales@biessecanada.com - www.biessecanada.com

PT. BIESSE INDONESIA

Tangerang, Indonesia
Tel. +62 21 53150568_Fax +62 21 53150572

BIESSE KOREA LLC

Gyungido, Korea
Tel. +82 32 3298780_Fax +82 32 3298781

BIESSE MALAYSIA SDN BHD

Selangor Darul Ehsan, Malaysia
Tel. +60 3 61401556_Fax +60 3 61402556
biessekl@tm.net.my

BIESSE TRADING (SHANGHAI) CO. LTD.

Subsidiary Office of Biesse Asia Pte. Ltd.
Shanghai, China
Tel. +86 21 5767 0387_Fax +86 21 5767 0391
mail@biesse-china.com.cn - www.biesse.cn

BIESSE RUSSIA

Representative Office of Biesse S.p.A.
Moscow, Russia
Tel. +7 495 9565661_Fax +7 495 6623662
sales@biesse.ru - www.biesse.ru

BIESSE GROUP AUSTRALIA PTY LTD.

Head Office
Sydney, New South Wales, Australia
Tel. +61 (0)2 9609 5355_Fax +61 (0)2 9609 4291
nsw@biesseaustralia.com.au - www.biesse.com.au
Melbourne, Victoria, Australia
Tel. +61 (0)3 9314 8411_Fax +61 (0)3 9314 8511
vic@biesseaustralia.com.au
Brisbane, Queensland, Australia
Tel. +61 (0)7 3622 4111_Fax +61 (0)7 3622 4112
qld@biesseaustralia.com.au
Adelaide, South Australia, Australia
Tel. +61 (0)8 8297 3622_Fax +61 (0)8 8297 3122
sa@biesseaustralia.com.au
Perth, Western Australia, Australia
Tel. +61 (0)8 9303 4611_Fax +61 (0)8 9303 4622
wa@biesseaustralia.com.au

BIESSE GROUP NEW ZEALAND PTY LTD.

Auckland, New Zealand
Tel. +64 9 278 1870_Fax +64 9 278 1885
sales@biessenewzealand.co.nz

BIESSE SCHWEIZ GMBH

Kriens, Swiss
Tel. +41 (0)41 3990909_Fax +41 (0)41 399 09 18
info@biesse.ch - www.biesse.ch

BIESSE MIDDLE EAST

Jebel Ali Free Zone, Dubai, UAE
Tel. +971 48878533_Fax +971 48878534
biessemiddleeast@biesse.com - www.biesse.com

Biesse Portugal WMP

Sintra, Portugal
Tel. +351 255094027_Fax +351 219758231
biesse@biesse.pt - www.biesse.com

BIESSE MANUFACTURING COMPANY PVT LTD.

Head office
Bangalore, India
Tel. +91 80 22189801/2/3_Fax +91 80 22189810
sales@biessemnfg.com - www.biessemanufacturing.com
Mumbai, India
Tel. +91 22 28702622_Fax +91 22 28701417
Noida, Uttar Pradesh, India
Tel. +91 120 428 0661/2_Fax +91 120 428 0663
Hyderabad, India
Tel. +91 9611196938 / +91 9700340612
Chennai, India
Tel. +91 9980566759 / +91 9443812286

Dati tecnici ed illustrazioni non sono impegnativi. Alcune foto possono riprodurre macchine complete di opzionali. Biesse Spa si riserva il diritto di apportare eventuali modifiche senza preavviso.

The proposed images and technical data are only indicative. The illustrated machines may be equipped with optional devices. Biesse Spa reserves the right to carry out modifications to its products and documentation without prior notice.

Die Abbildungen sind nicht verbindlich. Einige Fotos können Maschinen komplett mit Optionen zeigen. Biesse behält sich das Recht vor, Änderungen an den Produkten und Unterlagen ohne Ankündigung vorzunehmen.

Biesse S.p.A.

Via della Meccanica, 16 61122 Pesaro - Italy
Tel. +39.0721.439100_Fax +39.0721.439150
biesse.sales@biesse.com