

**Flexible.
Precise.
Unique.**

HE HOMAG

Our edge banding machines
EDGETEQ S-200 | S-300

YOUR SOLUTION





Perfect edges for discerning customers manufactured with flexible machines

Individual customer needs and preferences, sophisticated products and a wide range of materials – all factors which play a major role in today's woodworking industry. Here, production flexibility and efficiency are key – particularly for woodworking shops and medium-sized enterprises.

HOMAG offers unbeatable benefits and has a presence on the ground with international production plants and sales and service companies with around 6,000 staff members in over 100 countries around the world. Work with HOMAG to create a sharp competitive edge and security for your business in the long term.

We are:

YOUR SOLUTION

MORE: [HOMAG.COM](https://www.homag.com)



EDGETEQ
S-200 | S-300

CONTENT

- 04 Highlights of the models
- 06 Models 1110–1450 airTec, Highflex and edition
- 28 powerTouch / easy Touch control systems
- 30 Our units
- 45 Technical Data
- 52 LOOPTEQ return conveyor
- 54 Life Cycle Services



The easyTouch control system embodies a new generation of operating systems.

The touchscreen surface guarantees fast navigation and a high level of operating comfort. With model 1100–1200.



Control with powerTouch

Control machine functions directly using the multi-touch monitor in widescreen format.

The ergonomic design, as well as numerous help and assistant functions, simplify operation significantly.

With EDGETEQ S-300



Multi-stage technology

For easy profile change by push button. Saves time and improves quality.



Nesting package (optional)

Consisting of multiple tracing on trimming and scraper units. Use for bridging cup hinge holes, for example.

Edition series – all inclusive as standard:

THE MOST IMPORTANT FEATURES OF THE MODELS. The EDGETEQ series is characterized by its comprehensive equipment standard: Belt-type top pressure for precision workpiece guidance (from model 1400), optimized trimming tools for optimum chip disposal and perfect processing quality. Variable feed speed in various performance categories for high productivity. All the machines of the EDGETEQ series can also be extended. Additional processing units such as scrapers or buffing units can be mounted on selected machines which come with a free space. HOMAG EDGETEQ machines are energy-saving and environmentally friendly.

- **High-grade furniture with high edge quality**
- **More output through high availability**
- **Low energy requirement**
- **Outstanding economy**
- **Optimum cost-to-performance ratio**

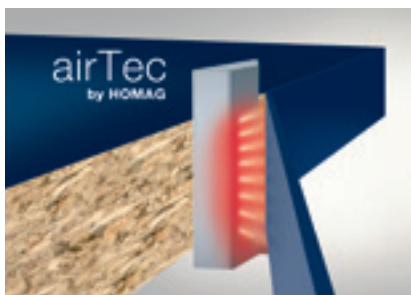

Zero joint technology with HOMAG airTec

The units are now equipped with a rotary air heater which makes the process significantly more efficient and quieter as well as saving resources.

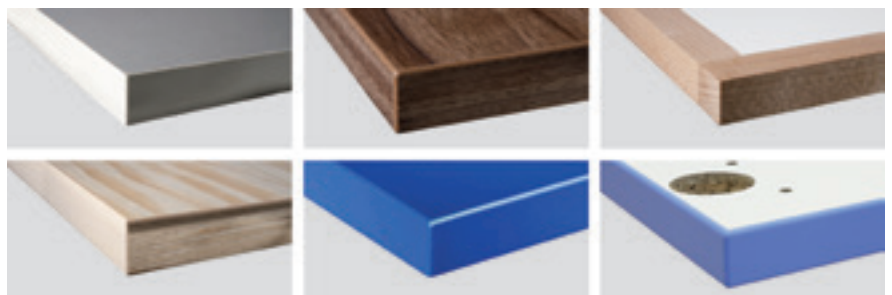

Wide range of materials

High flexibility is achieved as almost all materials can be processed: 0.4 mm melamine, 2 mm ABS, 8 mm solid strips, veneer, high gloss, nesting.

Feed speed: 8 m/min

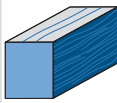
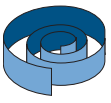
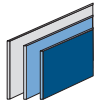
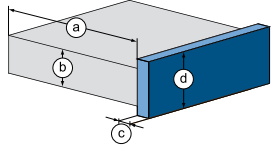
	SOLID (mm)	COILS (mm)	STRIPS (mm)
			
a	with b = 22: min. 70 with b = 40: min. 125		
b	8 – 40		
c	0.4 – 3.0	0.4 – 3.0	0.4 – 3.0
d	45		
			



EDGETEQ S-200 Models 1110 – 1110 F

The compact edge banding machines of the S-200 series are characterized by outstanding flexibility and intuitive operation. All the machines are equipped with a precise gluing unit (i.a. for processing of PUR-glue) and an automatic fixed length magazine for reliable material infeed. The magazine can be used for coil and fixed length material. The two-motor snipping unit guarantees a precise cut and optimum results. The flush trimming unit is easy to operate and can be reset with a quick, simple movement to the three different settings

flush, chamfer or radius.

The model 1110 F also features a joint trimming unit for optimum preparation of the workpiece.

The highlight of these machines is the finishing section, which offers 2 free spaces for outstanding flexibility.

The 3 units available here (profile scraper, glue joint scraper and buffing unit) can be positioned in varying combinations on the 2 free spaces as requested by the customer ex works.



EDGETEQ S-200

Model 1110

- 1** Gluing unit
- 2** Snipping unit
- 3** Trimming unit
- 4** Profile scraper (optional)
- 5** Glue joint scraper (optional)



Option

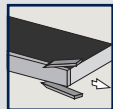

Option



Material types

- 0.4 mm melamine
- 2 mm ABS
- Veneer (coil)
- Nesting option

EDGETEQ S-200 model 1110 F

This model contains the same equipment as the model 1110, with the addition of a joint trimming unit.

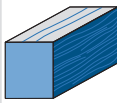
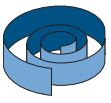
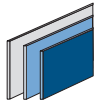
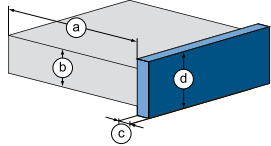
	SOLID (mm)	COILS (mm)	STRIPS (mm)
			
a	with b = 22: min. 70 with b = 40: min. 125		
b	8 – 40		
c	0.4 – 3.0	0.4 – 3.0	0.4 – 3.0
d	45		
			



EDGETEQ S-200 – Models 1120 C, 1120 F and 1120 FC

The compact edge banding machines of the EDGE TEQ S-200 series are characterized by outstanding flexibility and intuitive operation. All the machines are equipped with a precise gluing unit (i.a. for processing of PUR-glue) and an automatic fixed length magazine for reliable material infeed. The magazine can be used for coil and fixed length material. The two-motor snipping unit guarantees a precise cut and optimum results.

The flush trimming unit is easy to operate and can be reset with a quick, simple movement to the three different settings flush, chamfer or radius. The model 1120 FC includes a profile

trimming unit and a joint trimming unit to guarantee complete processing.

The highlight of these machines is the finishing section, which offers 2 free spaces for outstanding flexibility.

The 3 units available here (profile scraper, glue joint scraper and buffing unit) can be positioned in varying combinations on the 2 free spaces as requested by the customer ex works. One exception to this is the 1120 F model, which comes ex works without profile trimming tool, creating space for all three finishing units. The adjustment of the snipping unit and glue joint scraper comes as standard with pneumatic.

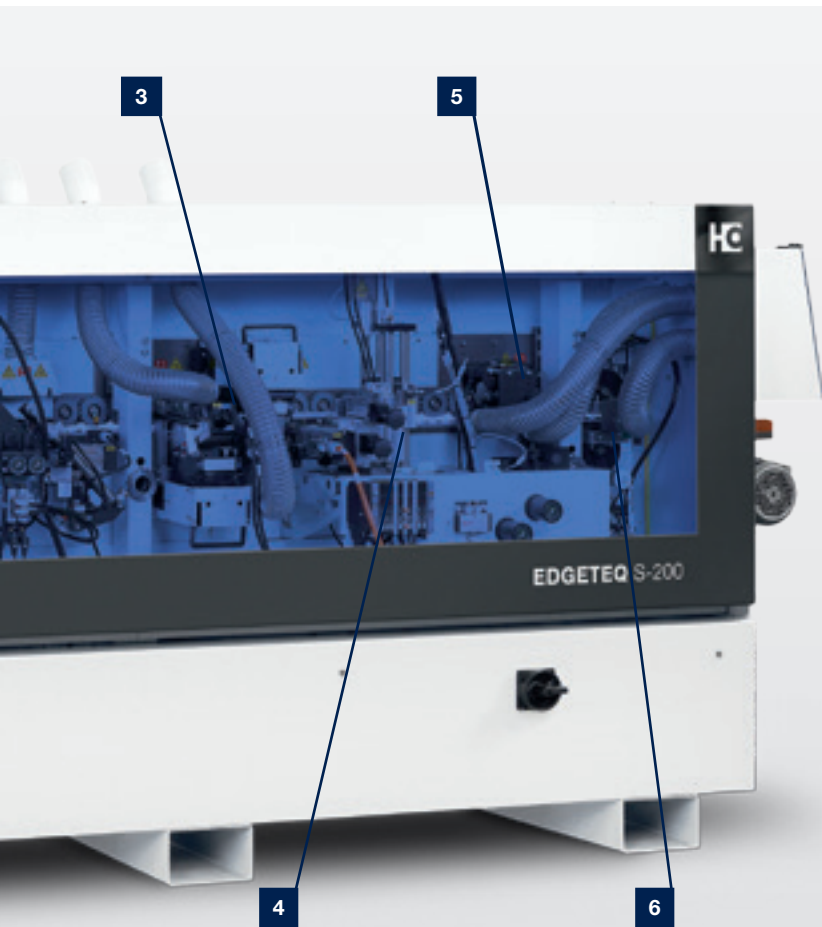

EDGETEQ S-200

Model 1120 C

- 1** Gluing unit
- 2** Snipping units
- 3** Trimming unit
- 4** Profile trimming unit
- 5** Profile scraper (optional)
- 6** Glue joint scraper (optional)

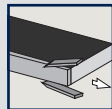
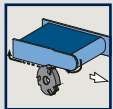
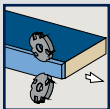

Option

Option



EDGETEQ S-200 Model 1120 FC

This model contains the same equipment as the model 1120 C, with the addition of a joint trimming unit.

Material types

- 0.4 mm melamine
- 2 mm ABS
- Veneer (coil)
- Nesting option

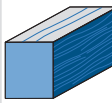
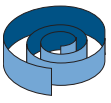
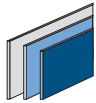
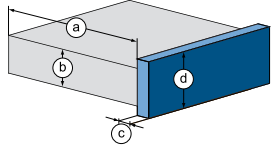
	SOLID (mm)	COILS (mm)	Strips (mm)
			
a	with b = 22: min. 70 with b = 40: min. 125		
b	8 – 40		
c	0.4 – 3.0	0.4 – 3.0	0.4 – 3.0
d	45		
			



EDGETEQ S-200 — Model 1130 FC

This machine offers a smart solution at an entry-level price point, specially designed for trade. A joint trimming unit prepares the edge to create an optimal joint. The precise gluing unit features a special coating that also allows easy processing of PUR adhesives.

The automatic fixed length magazine is equipped for a secure supply of material. The magazine can be used for coil and fixed length material. The two-motor snipping unit guarantees a precise cut and the best results with an easily adjustable pneumatics system. The impressive trimming unit can be simply adjusted between radius, chamfer and flush trimming.

In addition, there is a profile trimming unit for the complete processing of workpieces, including corner processing. The finishing area has three units, which are equipped with a pneumatically adjustable profile scraper with quick-change heads, a glue joint scraper, and a buffing unit.

The special feature in this performance class: three post-processing units in the finishing area operating alongside a profile trimmer. This integrated equipment guarantees full flexibility in the postprocessing of workpieces.



EDGETEQ S-200

Model 1130 FC

- 1** Joint trimming unit
- 2** Gluing unit
- 3** Snipping unit
- 4** Trimming unit
- 5** Profile trimming unit
- 6** Profile scraper
- 7** Glue joint scraper
- 8** Buffing unit

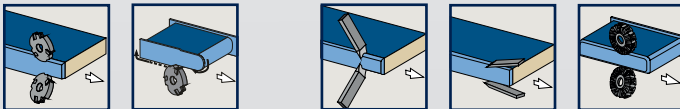

Material types

- 0.4 mm melamine
- 2 mm ABS
- Veneer (coil)
- Nesting option

Feed speed: 11 m/min

1



	SOLID (mm)	COILS (mm)	STRIPS (mm)
a	with b = 22: min. 70 with b = 40: min. 125		
b	8 – 50 (opt. 60)		
c	0.4 – 3.0 (opt. 6.0)	0.4 – 3.0	0.4 – 3.0
d	55 (opt. 65)		



EDGETEQ S-240 Models 1210 und 1210 F

The two machines are equipped with a precise gluing unit (i.a. for processing of PUR-glue), a tiltable two-motor snipping unit for straight and chamfer snipping, as well as a trimming unit.

For optimum workpiece preparation, a joint trimming unit (model 1210 F) is additionally available. A profile scraper and

the buffing unit ensure the perfect finish.

Alongside the machine's extensive unit equipment, automation of the units is also a possibility. Pneumatic adjustment of the snipping unit and pneumatic adjustment of the scraper are available in the standard version.



EDGETEQ S-240

Model 1210

- 1 Gluing unit
- 2 Snipping unit
- 3 Trimming unit
- 4 Profile scraper
- 5 Buffing unit

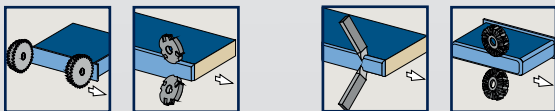

EDGETEQ S-240 Model 1210 F

This model contains the same equipment as the 1210 model, with the addition of a joint trimming unit.

Material types

- 0.4 mm melamine
- 2 mm ABS
- Veneer (coil)
- 3 mm solid strips (6 mm option)
- Nesting option

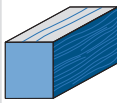
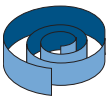
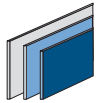
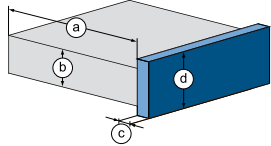
	SOLID (mm)	COILS (mm)	STRIPS (mm)
			
a	with b = 22: min. 70 with b = 40: min. 125		
b	8 – 50 (opt. 60)		
c	0.4 – 3.0 (opt. 6.0)	0.4 – 3.0	0.4 – 3.0
d	55 (opt. 65)		
			



EDGETEQ S-240 Models 1220 C, 1220 FC and 1230 FC

In developing the EDGETEQ S-240 series, the focus was on providing the complete processing capability previously reserved to the higher machine categories also at the entry level.

All the machines are equipped with a precise gluing unit (i.a. for processing of PUR-glue), a tiltable two-motor snipping unit for straight and chamfer snipping, as well as a trimming unit.

For complete processing, a joint trimming unit (apart from

model 1220 C), a profile trimming unit, a radius scraper and a buffing unit are available for the perfect finish.

The model 1230 FC additionally offers space in the finishing section for a glue joint scraper.

Alongside the machine's extensive unit equipment, automation of the units is also a possibility. Pneumatic adjustment of the snipping unit and pneumatic adjustment of the scraper are available in the standard version.

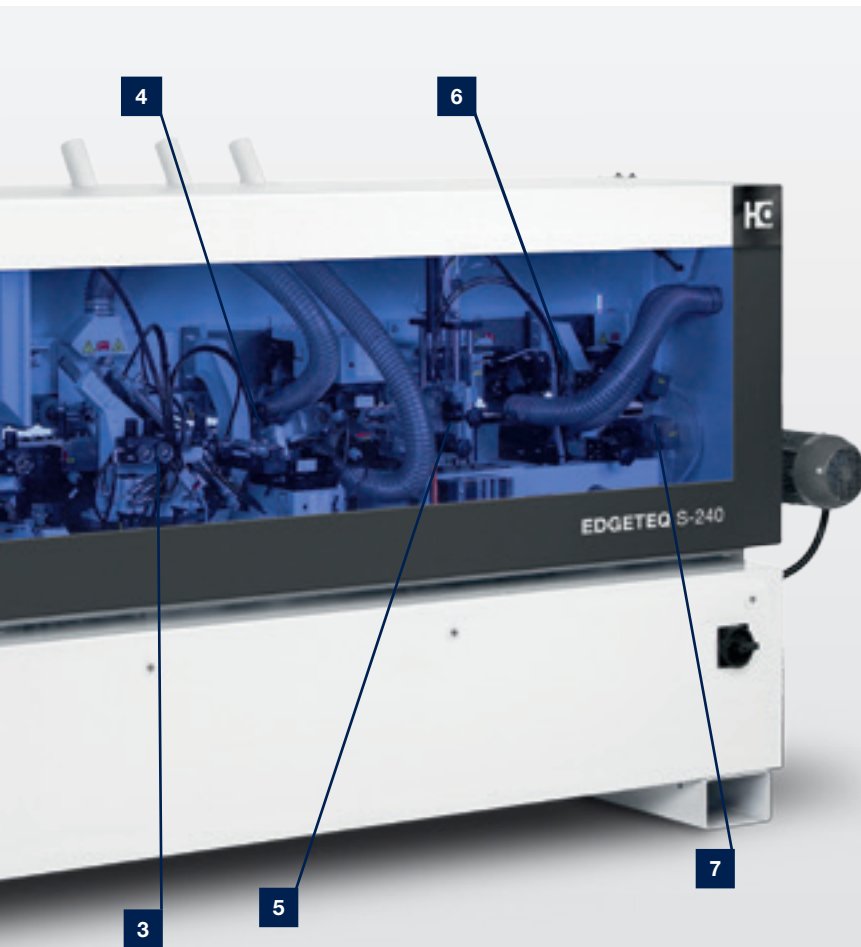

EDGETEQ S-240

Model 1220 FC

- 1** Joint trimming unit
- 2** Gluing unit
- 3** Snipping unit
- 4** Trimming unit
- 5** Profile trimming unit
- 6** Profile scraper
- 7** Buffing unit

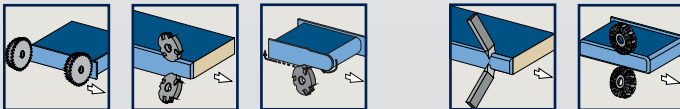

EDGETEQ S-240 Model 1230 FC

This model contains the same equipment as the machine 1220 FC, with the addition of a glue joint scraper.

Material types

- 0.4 mm melamine
- 2 mm ABS
- Veneer (coil)
- 3 mm solid strips (6 mm option)
- Nesting option

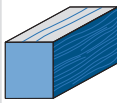
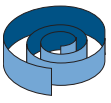
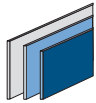
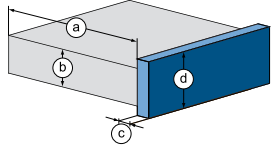
	SOLID (mm)	COILS (mm)	STRIPS (mm)
			
a	with b = 22: min. 70 with b = 40: min. 125		
b	60		
c	0.4 – 6.0	0.4 – 3.0	0.4 – 3.0
d	65		
			



EDGETEQ S-240 Models 1210 HF, 1220 HF and 1230 HF

All the machines are equipped with a precise gluing unit, a tiltable two-motor snipping unit for straight and chamfer snipping, as well as a trimming unit.

For complete processing, a joint trimming unit, a profile trimming unit, a radius scraper and a buffing unit are available for the perfect finish. The model 1230 HF additionally offers a free space in the finishing section for a glue joint scraper.

One exception is the machine 1210 HF. This comes ex works without profile trimming unit. The Highflex series is characterized by its high level of automation and a comprehensive range of processing units.

The high degree of flexibility enables adjustment to your specific needs and guarantees optimum edges.

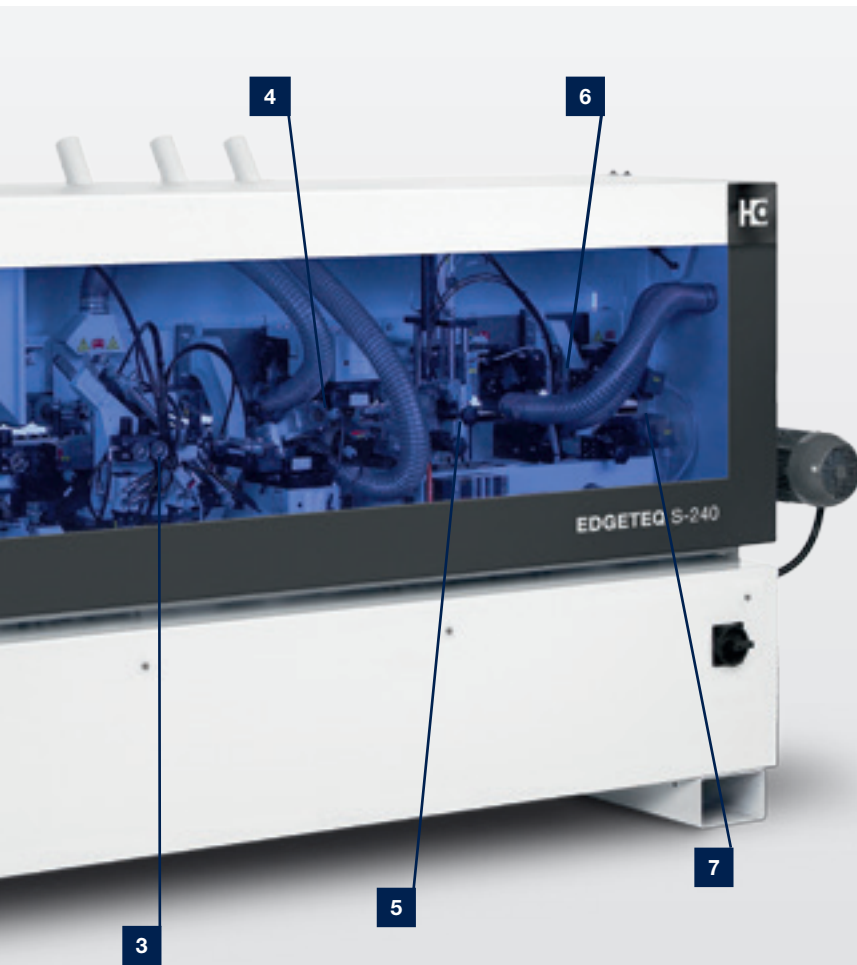

EDGETEQ S-240

Model 1220 HF

- 1** Joint trimming unit
- 2** Gluing unit
- 3** Snipping unit
- 4** Trimming unit
- 5** Profile trimming unit
- 6** Profile scraper
- 7** Buffing unit

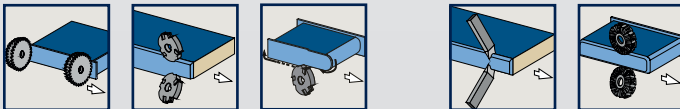

EDGETEQ S-240 Model 1230 HF

This model contains the same equipment as the 1220 HF, with the addition of a glue joint scraper.

Material types

- 0.4 mm melamine
- 2 mm ABS
- Veneer (coil)
- 6 mm solid strips
- Nesting option

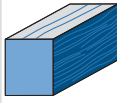
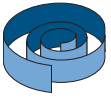
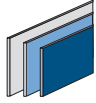
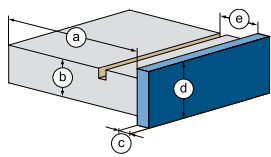
	SOLID (mm)	COILS (mm)	STRIPS (mm)
			
a	with b = 22: min. 70 with b = 40: min. 125		
b	8 – 60		
c	0.4 – 8	0.4 – 3.0	0.4 – 3.0
d	65		
e	max. 30 (only EDGETEQ 1440 FGC)		
			



EDGETEQ S-300 Models 1430 FC, 1440 FC and 1440 FGC

For woodworking shops and small or medium-sized enterprises, the EDGETEQ S-300 series secures competitive benefits in the long term.

In the basic version, the machines come equipped with a precise gluing unit, a 2-motor snipping unit, a trimming unit, a radius scraper, glue joint scraper and a buffing unit. Depending on the requirements, the machine can be

equipped with a joint trimming unit, a Quickmelt gluing unit for even more effective production, a rough trimming unit for heavy hogging operations, a profile trimming unit for corner rounding, a grooving unit and a glue joint scraper.

The optionally available machine automation packages reduce set-up times and offer a high level of operating convenience.

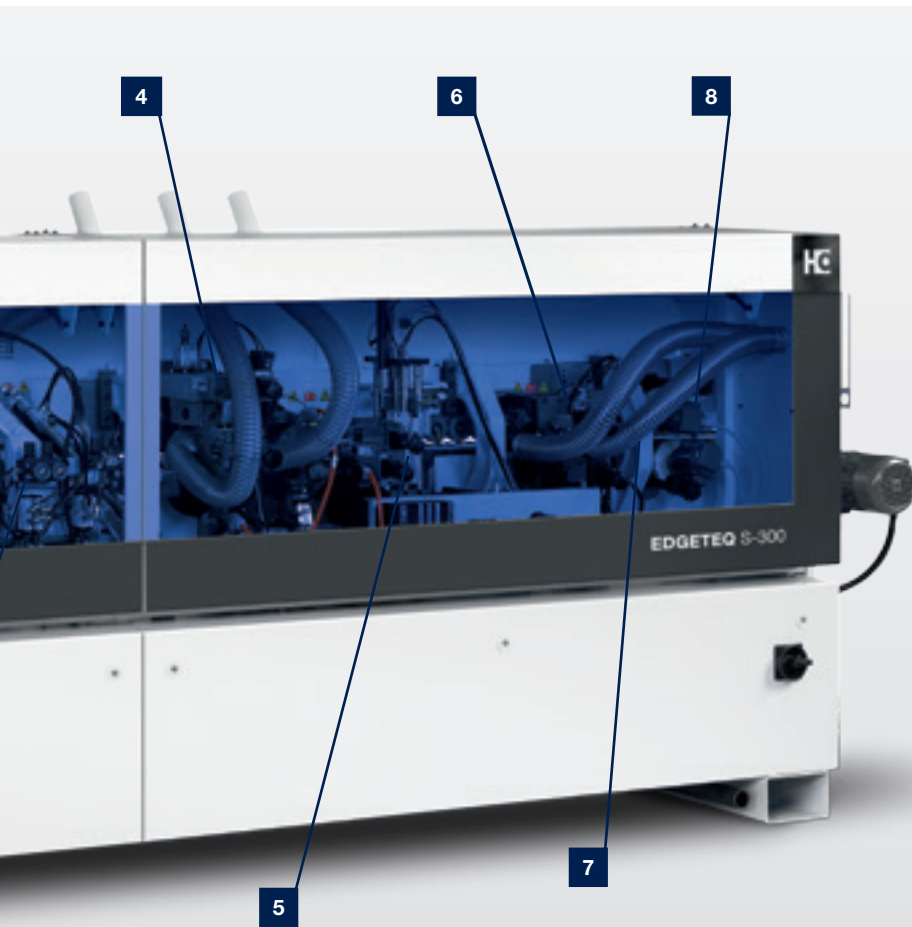

EDGETEQ S-300

Model 1430 FC

- 1** Joint trimming unit
- 2** Gluing unit
- 3** Snipping unit
- 4** Trimming unit
- 5** Profile trimming unit
- 6** Profile scraper
- 7** Glue joint scraper
- 8** Buffing unit

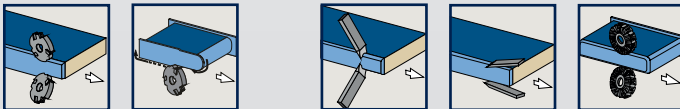

EDGETEQ S-300 Model 1440 FGC

This model contains the same equipment as the 1430 FC model, with the addition of a grooving unit.

Material types

- 0.4 mm melamine
- 2 mm ABS
- Veneer (coil)
- 8 mm solid strips
- High gloss option
- Nesting option

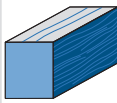
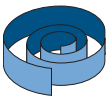
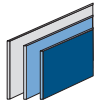
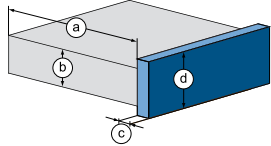
	SOLID (mm)	COILS (mm)	STRIPS (mm)
			
a	with b = 22: min. 70 with b = 40: min. 125		
b	8 – 60		
c	0.4 – 8.0	0.4 – 3.0	0.4 – 3.0
d	65		
			



EDGETEQ S-300 Models 1430 HF and 1440 HF

All the machines are equipped with a precise Quickmelt gluing unit, a tiltable two-motor snipping unit for straight and chamfer snipping, as well as a trimming unit. For complete processing, a joint trimming unit, a profile trimming unit, a radius scraper, a glue joint scraper and a buffing unit are available for the perfect finish.

The Highflex series is characterized by its high level of automation and a comprehensive range of processing units. The high degree of flexibility enables adjustment to your specific needs and guarantees optimum edges.

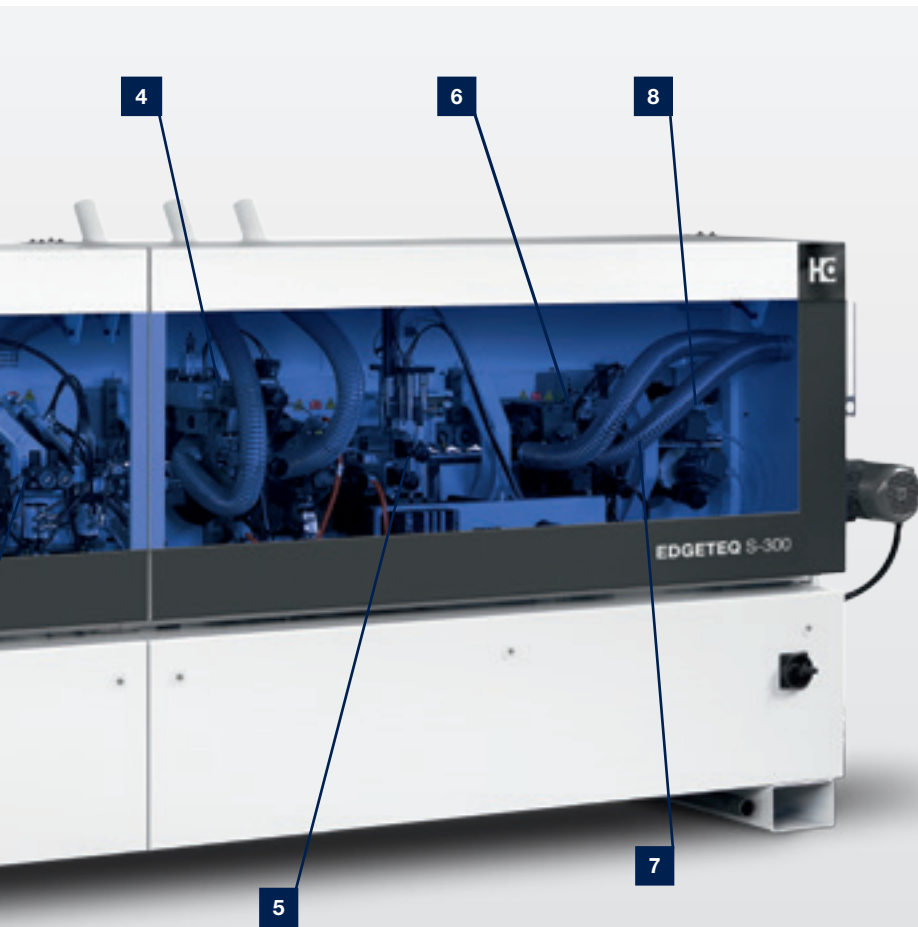

EDGETEQ S-300

Model 1430 HF

- 1** Joint trimming unit
- 2** Gluing unit
- 3** Snipping unit
- 4** Trimming unit
- 5** Profile trimming unit
- 6** Profile scraper
- 7** Glue joint scraper
- 8** Buffing unit

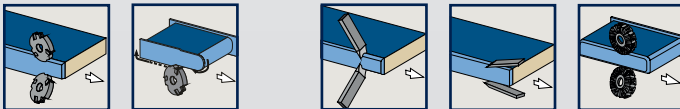

EDGETEQ S-300 Model 1440 HF

This model contains the same equipment as the machine 1430, with the addition of a dualmotor rofile trimming unit as an alternative.

Material types

- 0.4 mm melamine
- 2 mm ABS
- Veneer (coil)
- 8 mm solid strips
- High gloss option
- Nesting option

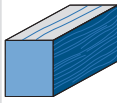
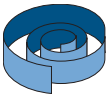
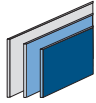
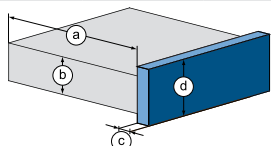
	SOLID (mm)	COILS (mm)	STRIPS (mm)
			
a	with b = 22: min. 70 with b = 40: min. 125		
b	8 – 60 8 – 40 (for airTec)		
c	0.4 – 3.0 (1200) 0.4 – 8.0 (1400)	0.4 – 3.0	0.4 – 3.0
d	65 45 (for airTec)		
			



EDGETEQ S-240 – S-300 Models 1220 AT, 1230 AT and 1440 AT

For joiners with high-end requirements, the EDGETEQ airTec models are ideal machines. Whether for production of the perfect zero-joint or for other edge processings, the machine always provides the perfect solution. The nerve center of these machines is the gluing unit, which alongside the airTec activation unit also acts as a dual solution, guaranteeing outstanding flexibility.

Alongside the magazine, all airTec machines are equipped with a joint trimming unit, a two-motor snipping unit, a trimming unit and a profile trimming unit. A radius scraper, glue joint scraper and a buffing unit ensure a perfect finish. The airTec models are characterized by their high level of automation and a comprehensive range of processing units.

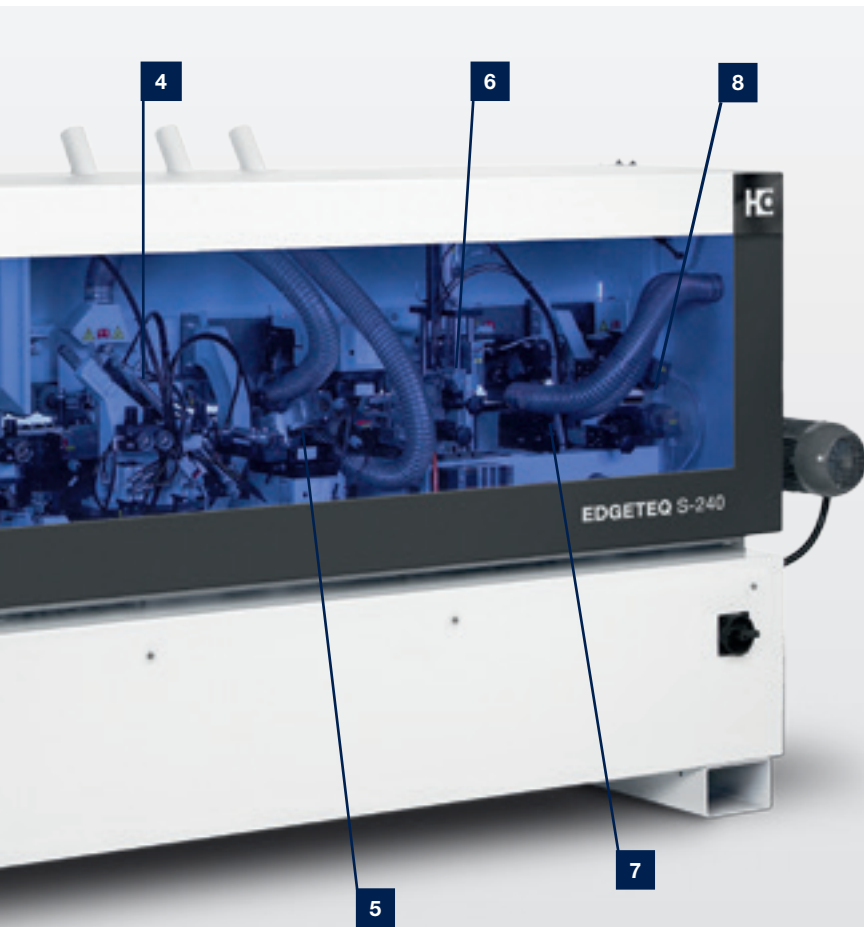

EDGETEQ S-240

Model 1220 AT

- 1** Joint trimming unit
- 2** airTec activation unit
- 3** Gluing unit
- 4** Snipping unit
- 5** Trimming unit
- 6** Profile trimming unit
- 7** Profile scraper
- 8** Buffing unit

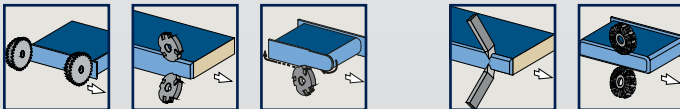

EDGETEQ S-240 Model 1440 AT

This model contains the same equipment as the 1220 AT model, with the addition of a dual-motor profile trimming unit as an alternative.

Material types

- 0.4 mm melamine
- 2 mm ABS
- Veneer (coil)
- 3 – 8 mm solid strips
- Nesting option

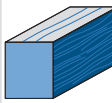
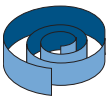
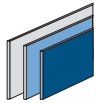
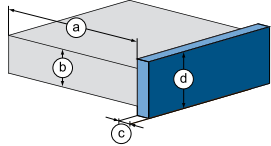
	SOLID (mm)	COILS (mm)	STRIPS (mm)
			
a	with b = 22: min. 70 with b = 40: min. 125		
b	8 – 60		
c	0.4 – 8.0	0.4 – 3.0	0.4 – 3.0
d	65		
			



EDGETEQ S-300 Model 1440 E

Even in their basic equipment configuration, this model offers a high level of automation and simple processing of several radii as standard.

The basic version is equipped with a joint trimming unit, a precise Quickmelt gluing unit, a two-motor snipping unit, a multi-stage trimming unit and a profile trimming unit. A multi-stage scraper, a glue joint scraper and a buffing unit ensure a

perfect finish.

The edition models are characterized by their high level of automation.

The multi-stage trimming unit and multi-stage scraper provide the optimum radius and consequently the very best results for frequently changing applications.

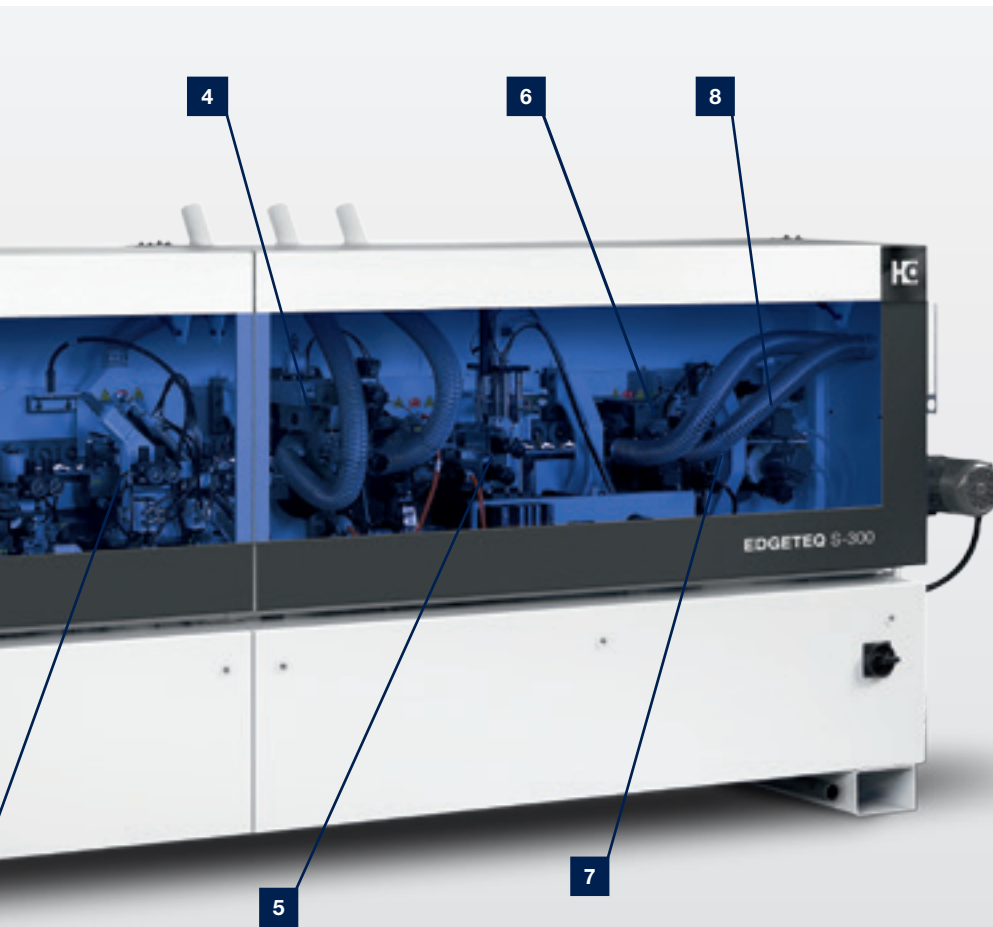

EDGETEQ S-300

Model 1440 E

- 1** Joint trimming unit
- 2** Gluing unit
- 3** Snipping unit
- 4** Multi-stage trimming unit
- 5** Profile trimming unit
- 6** Multi-stage scraper
- 7** Glue joint scraper
- 8** Buffing unit

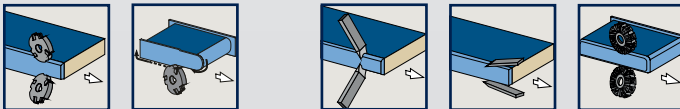

Material types

- 0.4 mm melamine
- 2 mm ABS
- Veneer (coil)
- 8 mm solid strips
- High gloss
- Nesting option

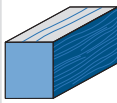
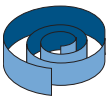
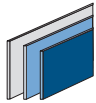
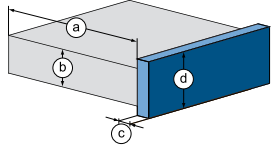
	SOLID (mm)	COILS (mm)	STRIPS (mm)
			
a	with b = 22: min. 70 with b = 40: min. 125		
b	8 – 60		
c	0.4 – 8.0	0.4 – 3.0	0.4 – 3.0
d	65		
			



EDGETEQ S-300 Model 1450 FC

To offer an optimal solution, the basic machine of the 1450 FC model is fitted with a joint trimming unit, a precise gluing station, a dual-motor snipping unit with pneumatic adjustment, a trimmer, and a dual-motor profile trimming unit. A pneumatically adjustable profile scraper with quick-change heads, a glue joint scraper, and a buffing unit provide the perfect finish.

If required and on request, the machine can be converted into an Edition model offering full automation at the factory.

In addition to automating the entire machine, the focus here is on postprocessing. The multi-stage technology is used on the trimmer unit and scraper.

. The radii can be changed easily at the press of a button as the units are fitted with NC axes.

This means that the entire machine is equipped with multi-stage technology and the customer is free to change radii in line with their requirements. Full flexibility is guaranteed, and all individual customer requests can be taken into account.

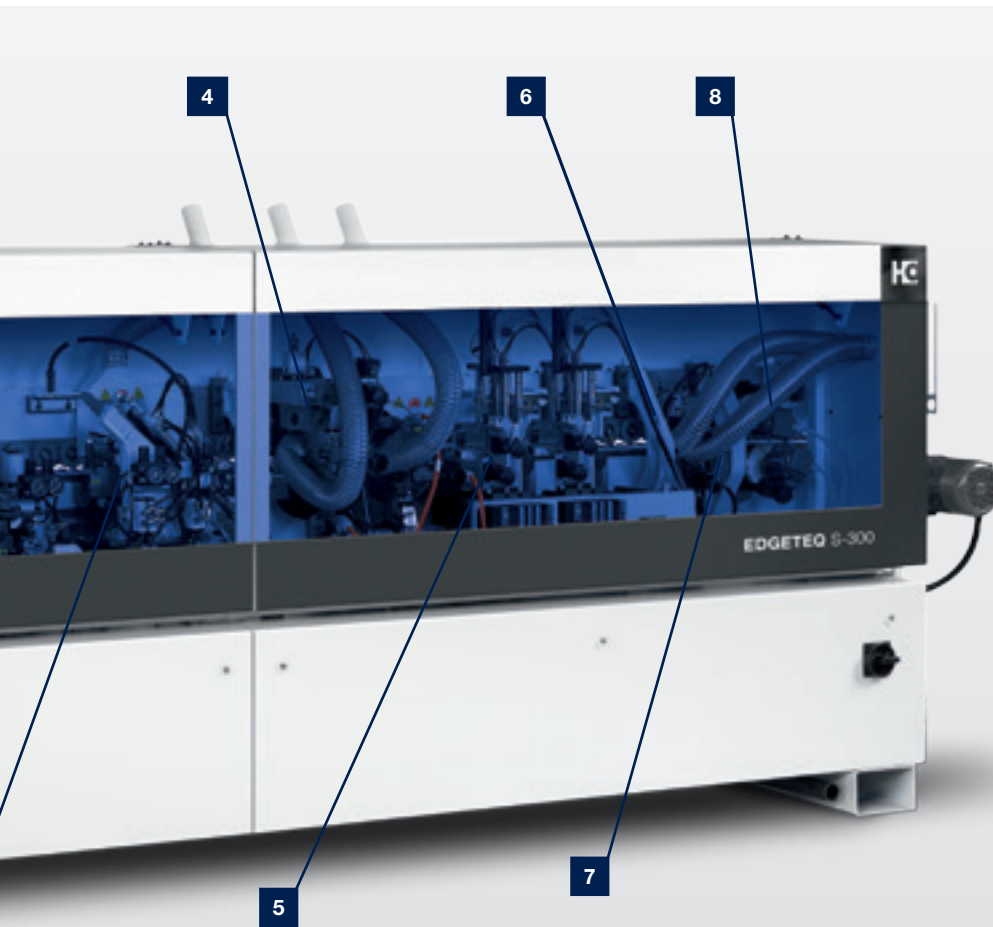

EDGETEQ S-300

Model 1450 FC

- 1** Joint trimming unit
- 2** Gluing unit
- 3** Snipping unit
- 4** Trimming unit
- 5** Profile trimming unit
- 6** Profile scraper
- 7** Glue joint scraper
- 8** Buffing unit

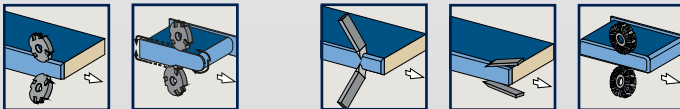

Material types

- 0.4 mm melamine
- 2 mm ABS
- Veneer (coil)
- 8 mm solid strips
- High gloss
- Nesting option



powerTouch – The new dimension of machine control units

powerTouch represents the operating philosophy of HOMAG: standardized, easy, ergonomic, and evolutionary. The innovative touchscreen operating concept combines design

and function in a completely new generation of control systems. With EDGETEQ S-300.

At the heart of the concept is a large, widescreen multitouch monitor that allows machine functions to be controlled directly by touch. The entire programming interface is optimized for powerTouch operation and offers numerous new help and assistant functions that make working processes substantially easier. Standardized operating elements and software modules ensure that all HOMAG edge banding machines from EDGETEQ S-300 can be operated in the same way using this new concept. They differ only in a few machines-specific details. This not only simplifies operating different machines, but also makes for greater efficiency by significantly reducing the time spent on training and service.



Teleservice reduces on-site service visits

- Reduction in service costs
- Avoids unplanned machine downtimes
- Targeted planning for service visits and spare parts delivery
- Support for maintenance and operating personnel

The benefits

- **15,6" monitor with full HD resolution**
- **Fast overview of machine status**
- **Easy, user-oriented navigation**
- **Guided path to production readiness through traffic light indicator**
- **New ergonomic design of the operating panel**
- **Intuitive, natural touch operation on the machine**
- **Use of gestures, e.g. scrolling, swiping**



easyTouch – Simple touches with effective results

The easyTouch control system embodies a new generation of operating systems. The touchscreen surface guarantees fast

navigation combined with a high level of operating comfort. With EDGETEQ S-200 – S-240.

The benefits

- Clear 7" graphic display provides optimum control via touching the control panel directly
- 20 storable programs guarantee flexibility when processing a wide variety of edge materials and changing customer requirements
- Production readiness displayed by traffic light indicator
- Ability to adjust units quickly thanks to direct access via ctrl keys
- Intuitive, user-oriented navigation
- Clear overview of the help and assistant functions, including the glue pot temperature or troubleshooting in plain text

Betriebsdatenerfassung		1, 2mm ABS
Stunden Gesamt	h	127496,00
Werkstücke Gesamt	Stk	488217
Kantenlänge Gesamt	m	164921
Stunden	h	0,45,00
Werkstücke	Stk	100
Kantenlänge	m	223,00

Exact recording of operating hours per commission due to state-of-the-art operating data acquisition

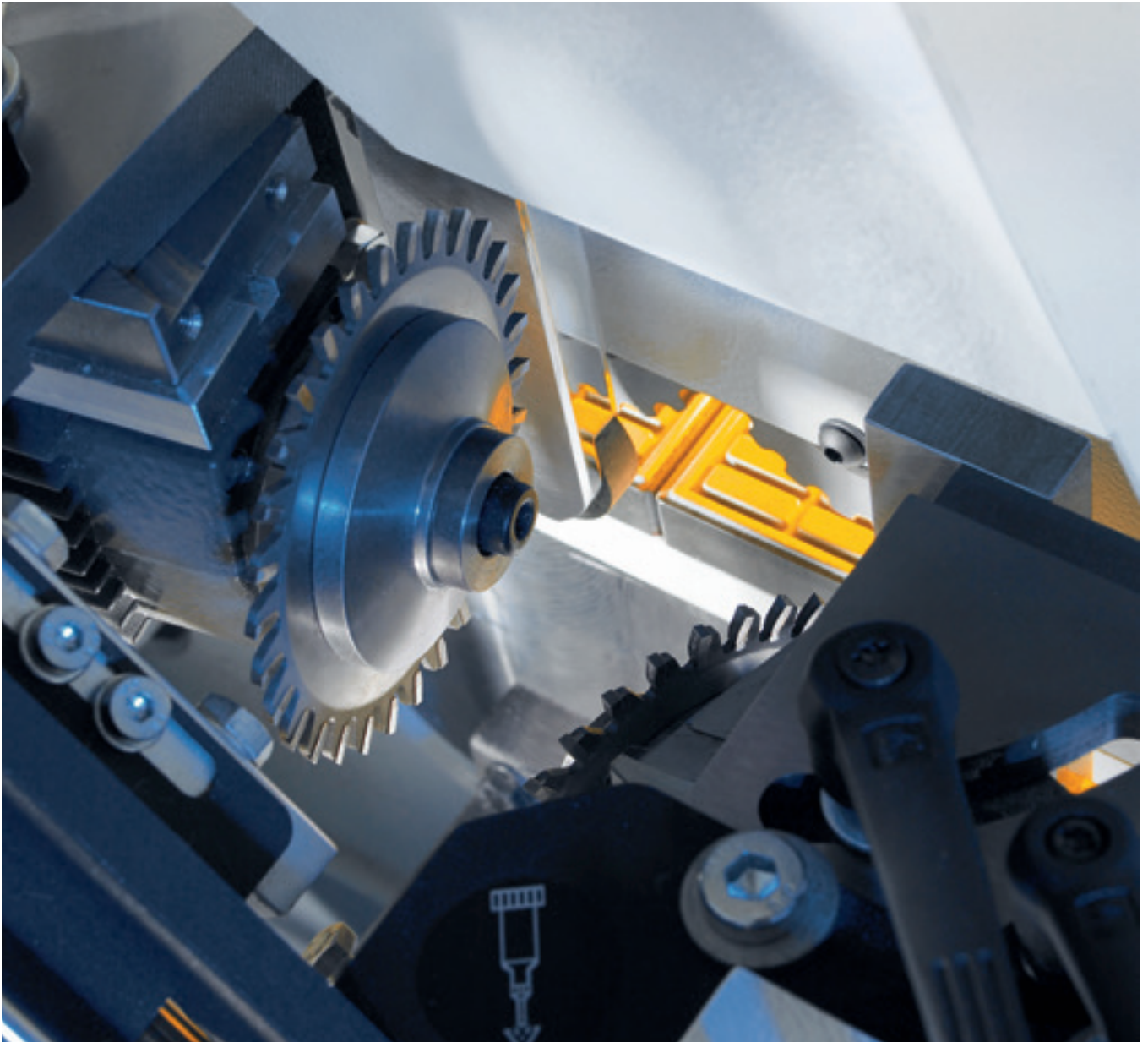

Our range of modular units: The right solution no matter what the requirement

For wide-ranging different processing tasks, we use units from our tried and tested modular range. By continuously extending the offered functions, we ensure that you have the right solution available to cope with changing trends.

Presenting a range of units for joint trimming, gluing, snipping, profile trimming, grooving and finish processing. Their extreme precision and state-of-the-art technology will boost the flexibility and efficiency of your production.

Workpiece feeding

Precise workpiece feeding is a pre-condition to achieve perfect edge quality. Our solutions are your benefit: infeed

fence, infeed stop, sliding carriage or workpiece support.



Infeed stop

For minimum workpiece spacing and safe operation.
With EDGETEQ S-300.



Insertion device (optional)

Automatic edge infeed for quick edge changes between different rolls of material.
With EDGETEQ S-240 – S-300.



Air cushion table (optional)

For easy workpiece feeding.



Automatic infeed guide adjustment (optional)

Precise, repeatable program-controlled infeed guide adjustment by means of servo axis.
With EDGETEQ S-300.



Sliding carriage (optional)

Robust linear guiding system to secure right-angled workpiece feeding.
With EDGETEQ S-300.



Belt-type top pressure (optional)

Belt-type top pressure available as an option instead of the standard roller pressure system
With EDGETEQ S-300.

Spraying units

Separating agent spraying units optimally prepare your workpieces for gluing, as separating agents prevent hot-melt glue residue from sticking. Glue residues are simply removed by cleaning agent sprays. Lubricant is applied to protect

sensitive surfaces before trimming and to prevent gloss marks on the workpieces.

The spraying units thus achieve an optimum workpiece quality.



Spraying unit

Spraying agents for optimal processing results, even for sensitive surfaces.

With EDGETEQ S-240 – S-300.

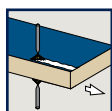

Joint trimming units

The HOMAG joint trimming units provide the perfect basis for splinter-free workpiece edges and glue joints with a

consistently high standard of product quality.

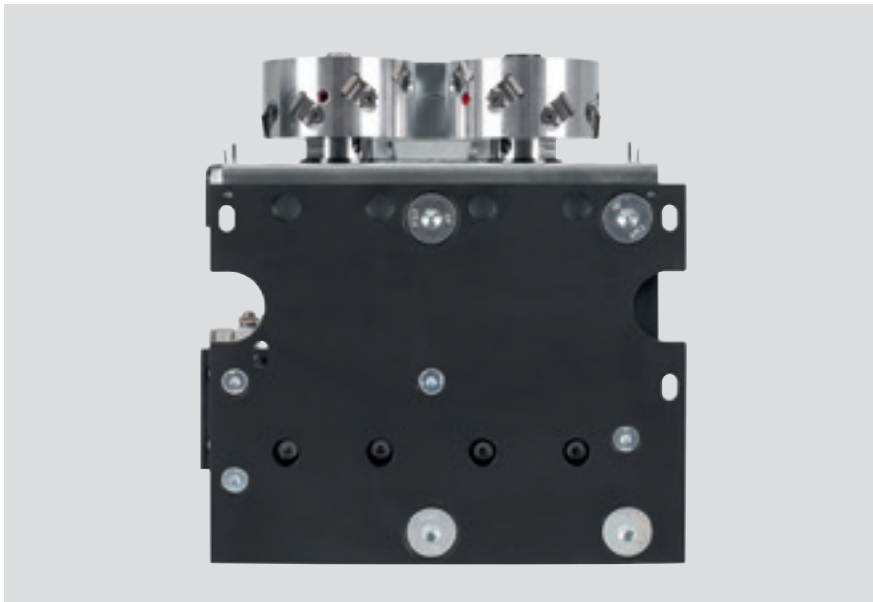

Joint trimming unit

Perfect cut and high operating life due to diamond tipped tools for an optimum edge joint quality. The diameter is 100 mm. With EDGETEQ S-200.

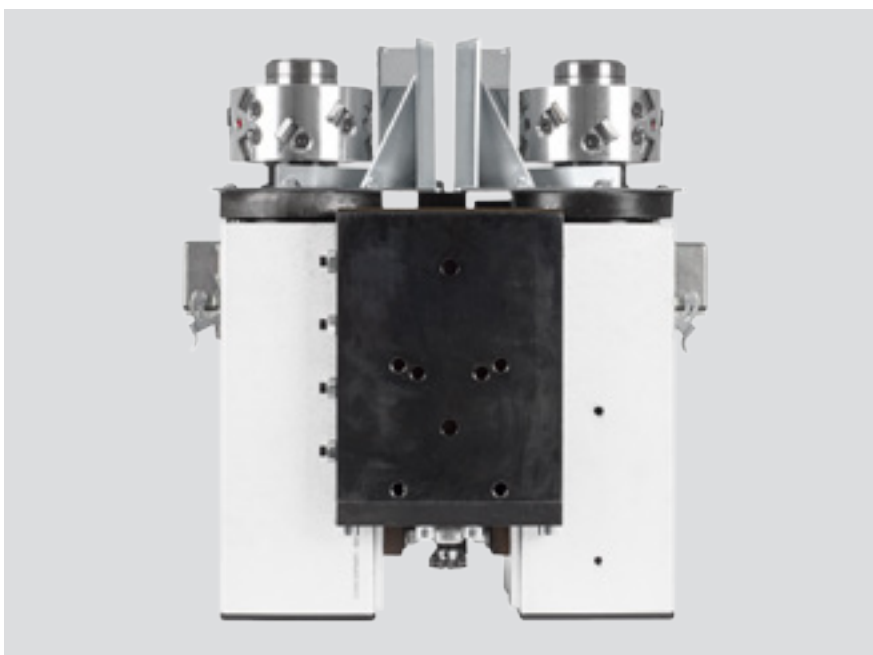

Joint trimming unit

Perfect cut and high operating life due to diamond tipped tools for an optimum edge joint quality. The diameter is 100 mm. With EDGETEQ S-240 – S-300.



Gluing units – reliable hot melt glue application

HOMAG gluing units are ideal for a fast, positive-locking glue bond. The heated glue roller ensures an optimum gluing temperature. On request, the gluing unit can be equipped

with a PU pre-melting unit (from Ambition 1400) for a high level of availability and optimum gluing quality.

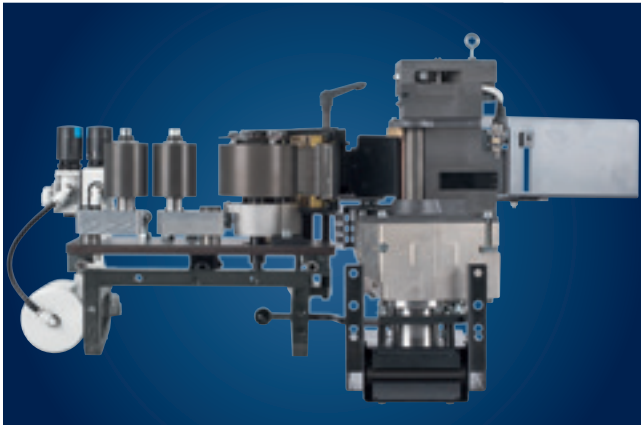

Your benefits at a glance

- Optimum glue application on the narrow surface
- Changes to workpiece thicknesses do not necessitate resetting of the glue application roller
- Glue roller lift-off on feed stop
- Glue roller with integrated heating guarantees constant temperature and viscosity for all workpiece thicknesses
- Electropneumatic glue roller and tank clamping prevents glue soiling on the trailing edge of the workpiece
- Tracing pad prevents wear of the application roller and ensures a consistent glue film thickness
- Easy removal of the application unit with quick-release lock

Gluing units

Quick-change application unit with hot melt glue supply from beneath. Can process PUR granulate.

Top image: with EDGETEQ S-200.

Bottom image: with EDGETEQ S-240.



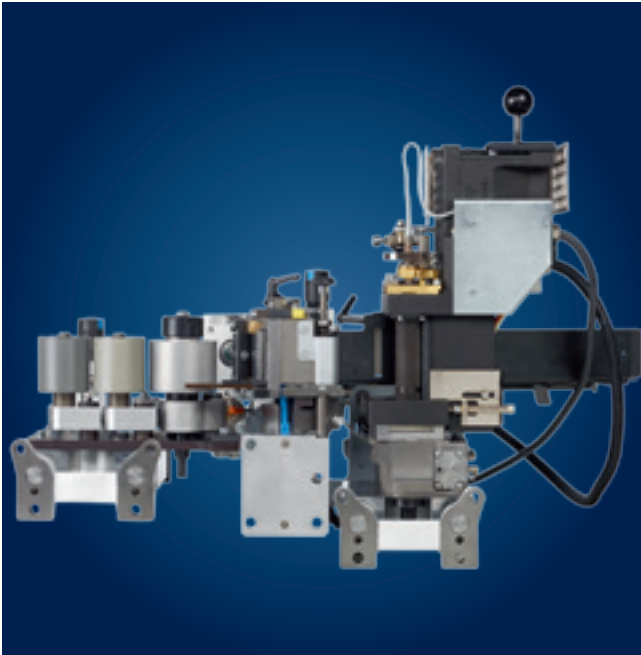

QA65N glue application system – gravity fed

The application unit can be easily removed by means of a quick-change device with pneumatic interface.
From EDGETEQ S-240 Modell 1220 AT to EDGETEQ S-300.

**Your benefits at a glance
- QA 65 N**

- Short heating-up time by sensed level control (2 levels selectable)
- The application unit can be easily removed by means of a quick-release lock for melting hot-melt glue either automatically or manually
- Glue roller with integrated heating guarantees constant temperature and viscosity for all workpiece thicknesses
- Electropneumatic glue roller and tank clamping prevents glue soiling on the trailing edge of the workpiece
- Tracing pad prevents wear of the application roller and ensures a consistent glue film thickness
- Glue roller lift-off on feed stop



Service station

- Compact, mobile pre-heating and cleaning station for the application unit QA65N with two storage containers and a storage area
- High flexibility through the use of 2 vacuum containers, each for one QA65N application unit
- No vacuum pump (Venturi nozzle) required as the vacuum is generated using your existing compressed air supply
- By storing in vacuum, no nitrogen is required

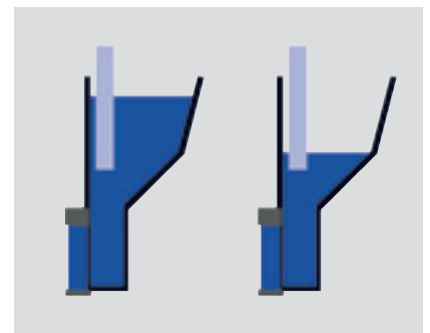

Sensor for checking the fill level of the application unit

Switching to a lower glue level guarantees a fast heat-up time for processing small batch sizes.

Systematic gluing

Achieving perfect gluing results depends on the optimum interaction of entirely different factors. The workpiece pre-heating, the application unit, quick clamping system, melting

unit, magazine and pressure zone from HOMAG are all designed for optimum coordination.

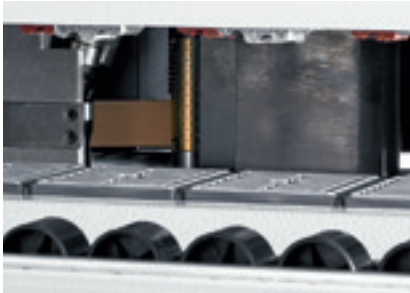

Workpiece pre-heating with contact heating shoe

High-strength gluing due to optimum workpiece pre-heating.
With EDGETEQ S-240.



Workpiece pre-heating with heaters

High-strength gluing due to optimum workpiece pre-heating.
With EDGETEQ S-300.



Pre-melting unit (optional)

High degree of availability and optimum gluing quality thanks to the quick-melt gluing station.
With EDGETEQ S-300.



Pressure zone EDGETEQ S-200

Pressure zone up to an edge thickness of 3 mm and a panel height of 40 mm for optimum glue joint quality.



Pressure zone EDGETEQ S-240 – S-300

Heavy pressure zone up to an edge thickness of 3 mm and a panel height of 50 mm for optimum glue joint quality (optional: 6 mm edge thickness for 60 mm panel height).



Roller counter pressure

Roller counter pressure for sensitive edge material.
With EDGETEQ S-200 – S-300.

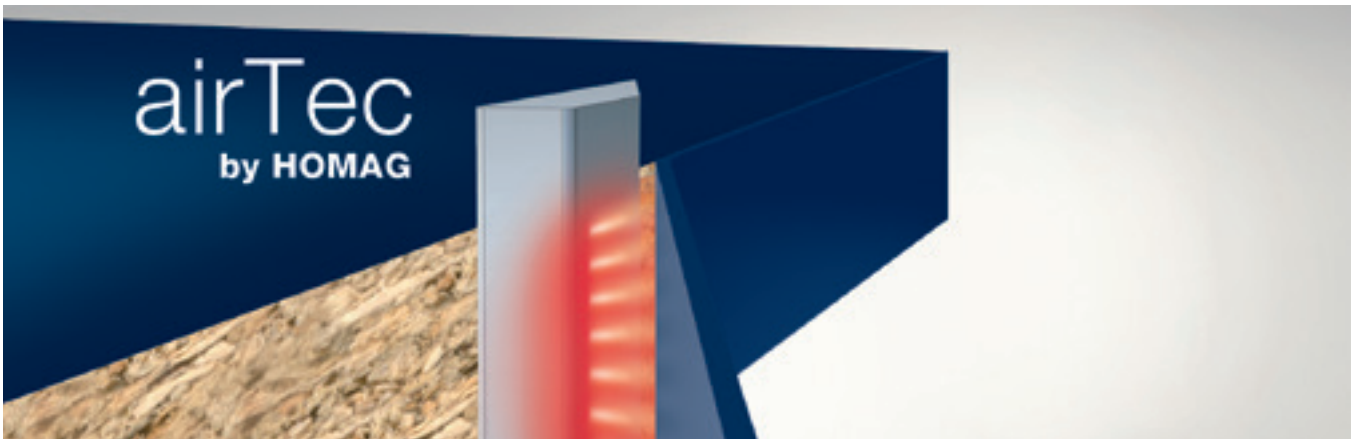

airTec – the ideal entry into zero joint technology

The airTec process has become an established zero joint solution in woodworking shops and SMEs. HOMAG's answer to the growing demand is an innovative, more efficient and resource-saving airTec solution. The nerve center of the new airTec unit is a rotation air heater which not only

enhances efficiency but also operates with significantly lower noise emissions. airTec can be used to process all types of currently popular, laser-suitable edging types. This means great flexibility for all materials and colors.



Edge banding “without joints”

The airTec method bonds the edging to the panel using hot air. This requires the use of special edges. These comprise a decor layer and a function layer. The HOMAG airTec unit melts the function layer at an even temperature and flow rate and bonds it perfectly to the narrow surface.

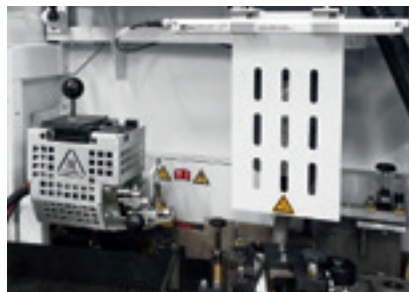

Easy integration

The airTec reactivation unit is installed in such a way that it is possible to work with either the standard application unit or the airTech system.
Image EDGETEQ S-300

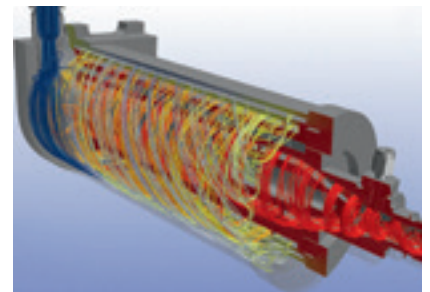

Innovative rotation air heater

The new source of energy heats the air while at the same time acting as a heat store for subsequent repeated air heating. In addition, less air is required and the heating effect on the surrounding area is minimized. Any noise is almost exclusively produced during the activation process and is below the noise level of other processing units.
With EDGETEQ S-300.

Snipping units for cutting the face side overhang

The snipping units prepare the workpieces perfectly for subsequent trimming operation. The face side can be

snipped either straight or with chamfer.

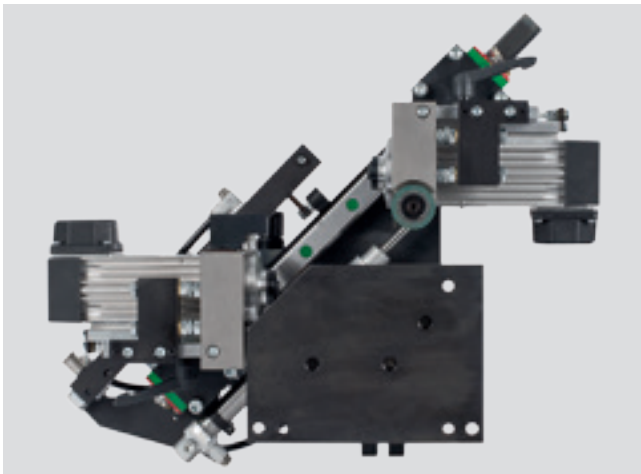

Snipping unit

Exact snipping cut using a robust snipping unit with a highly precise linear guide.
With EDGETEQ S-200.

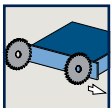

Snipping unit

Exact snipping cut using a robust snipping unit with a highly precise linear guide. Swivels to easily adjust for chamfer or straight snipping (optional: adjustment using pneumatics).
With EDGETEQ S-240 – S-300.

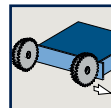

Trimming units for flush trimming

The rough trimming and fine trimming units offer the perfect solutions for processing edge overhangs.

The trimming units are equipped exclusively with tools capable of controlled chip capture.



Trimming unit

Trimming unit with DFC tool technology (Dust Flow Control) for optimal extraction. With EDGETEQ S-200 – S-240.

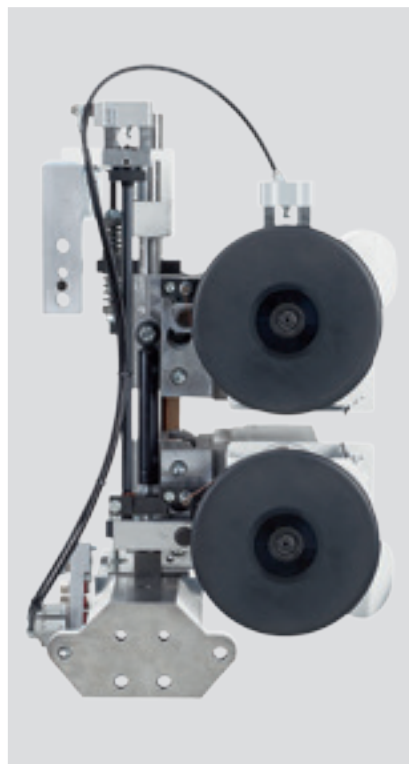
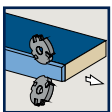

Rough trimming unit

For rough trimming of all common edge banding materials. With EDGETEQ S-300.

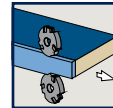

Trimming unit

Flexibility for different edge thicknesses and profiles thanks to NC axes. With EDGETEQ S-300.

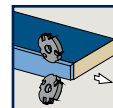

Trimming with multi-stage technology

The range of edges and panel materials is continually growing and so is the demand for flexibility. It is immaterial if edges are made from plastic, solid wood or veneer, or if workpieces have high-gloss surfaces.

The multi-stage trimming unit always offers the optimum radius for frequently changing applications, and therefore the best results.



Multi-stage trimming unit MS40/45

Fully automatic changeover to three different profiles using servo motors*.

Image shows nesting package.

Bei EDGETEQ S-300.

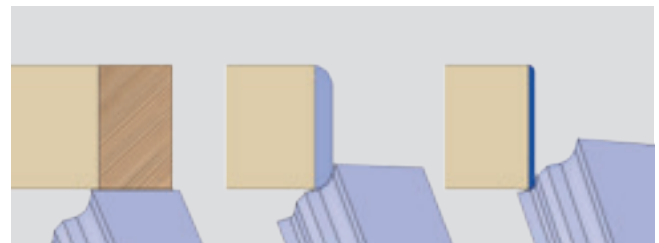

1. Plan

2. Profile 1

3. Profile 2

* Servo motors: Servo drives consist of motors with a stepless adjustment. They impress thanks to a high positioning accuracy and are particularly suitable for small positioning distances.



Profile trimming units

The profile trimming units are universal. The user has the choice to adjust the units manually or to control them via

program.

The design is then carried out up to a speed of 14 m/min.



Profile trimming unit FF10

Optimum profile trimming without making adjustments thanks to linked DIA tool and tracing roller.
Workpiece thickness up to 60 mm.
With EDGETEQ S-200 – S-300.

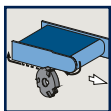

Profile trimming unit FF20

For rounding corners on thick PVC edges, as well as top edges on post-forming and soft-forming parts. Equipped with an automatic adjustment to switch between thin and thick edges. Workpiece thickness up to 60 mm.
With EDGETEQ S-300.

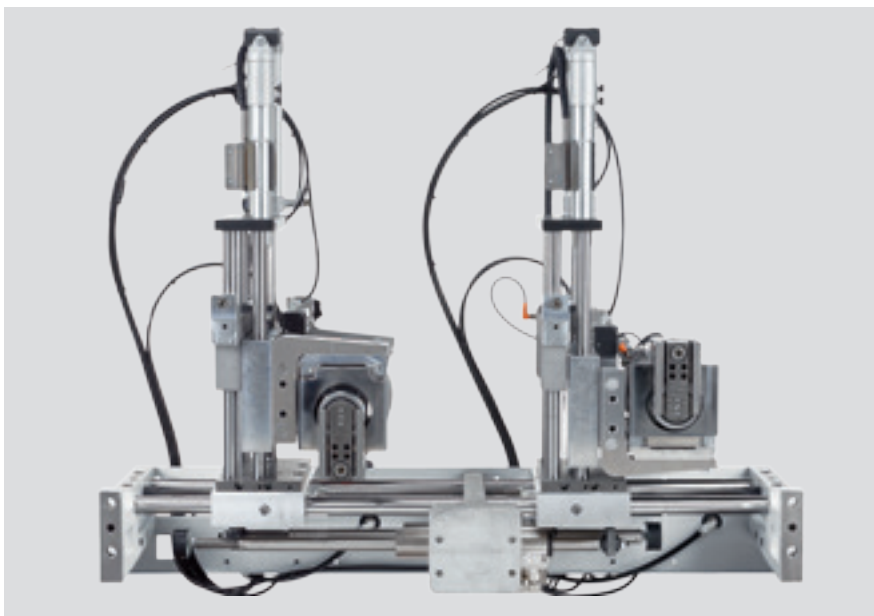
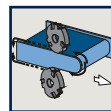

Multifunctional trimming unit MF50

Trimming of the top and bottom edge overhang as well as corner copying on the front and rear edges. Equipped with an automatic adjustment to switch between thin and thick edges. Workpiece thickness up to 60 mm.
With EDGETEQ S-300.

Automation to suit every need

Automatic adjustment between two different radii is possible.

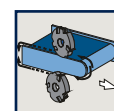



Grooving unit

A swiveling grooving unit is available for grooving. If required, the workpiece underside and the front side can be grooved.

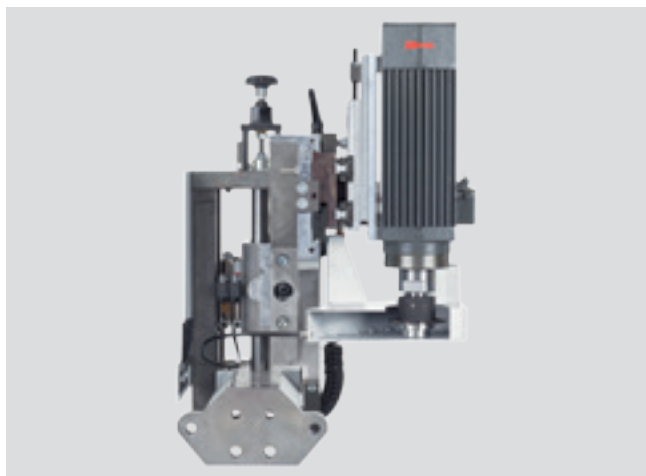

Grooving unit

A swiveling grooving unit is available for grooving. If required, the workpiece underside and the face side can be grooved. With EDGETEQ S-300 Model 1440 FGC.



Finishing units

HOMAG ensures the optimum quality of your products with a range of ideally coordinated finishing units.



Profile scraper

Unit to smooth radii or chamfers, equipped with quick change heads for fast profile change.

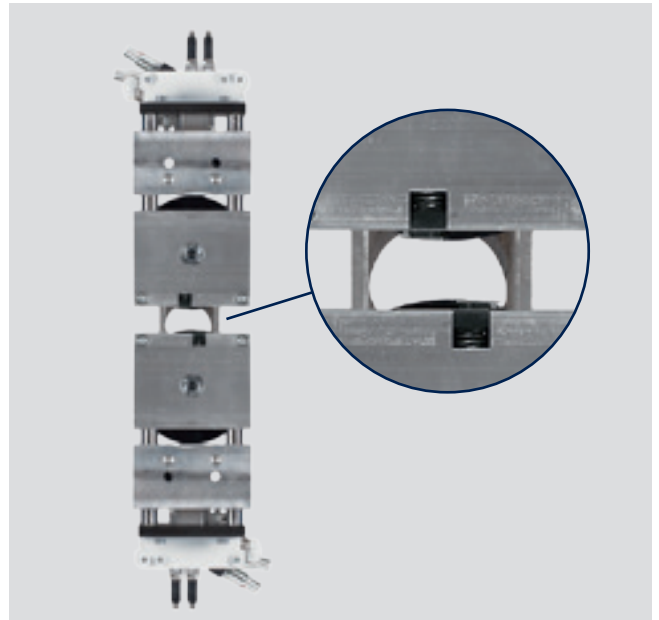
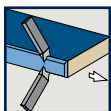

Glue joint scraper

For the perfect finish.

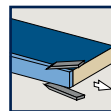

Buffing unit

To polish edges and maintain their natural color.

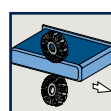

Finish with multi-stage technology

The range of edges and panel materials is continually growing and so is the demand for flexibility. It is immaterial if edges are made from plastic, solid wood or veneer, or if workpieces have high-gloss surfaces.

The multi-stage scraper always offers the optimum radius for frequently changing applications, and therefore the best results.

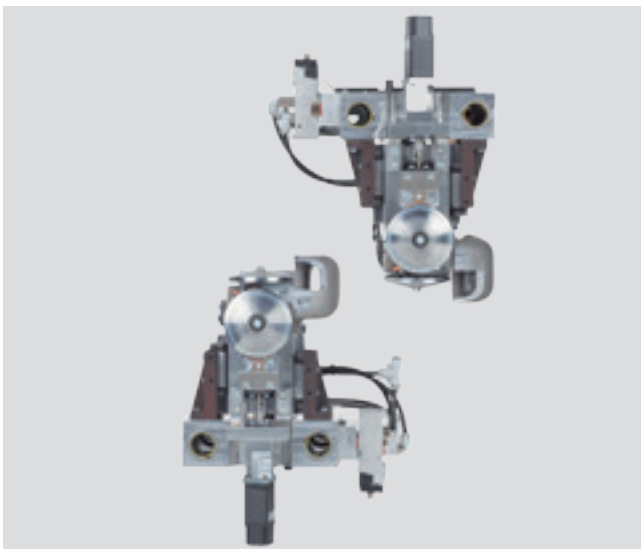

Multi-stage scraper MZ40

Fully automatic changeover to two different profiles using servo motors*. With EDGETEQ S-300.

* Servo motors: Servo drives consist of motors with a stepless adjustment. They impress thanks to a high positioning accuracy and are particularly suitable for small positioning distances.

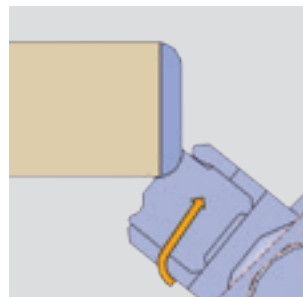

1. Profile 1

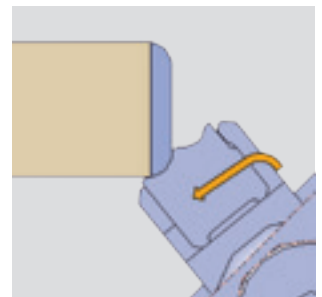

2. Profile 2

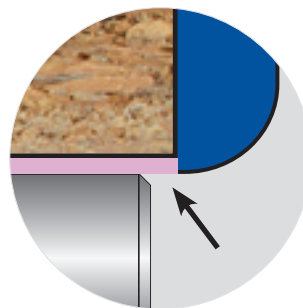

Optimum compensation for protective films

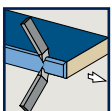

TECHNISCHE DATEN EDGETEQ S-200 BAUREIHE

MACHINE DIMENSIONS	Model 1100	Model 1110 F	Model 1120 C	Model 1120 FC	Model 1120 F	Model 1130 FC
Overall length (mm)	3,672	3,672	4,270	4,270	4,270	4,570
Working height (mm)	950	950	950	950	950	950
WORKING DIMENSIONS						
Workpiece width (mm)						
with workpiece thickness 8 – 22 mm	70	70	70	70	70	70
with workpiece thickness 23 – 40 mm	120	120	120	120	120	120
Workpiece thickness (mm)	8 – 40	8 – 40	8 – 40	8 – 40	8 – 40	8 – 40
Edge thickness, coils (mm)	0.4 – 3	0.4 – 3	0.4 – 3	0.4 – 3	0.4 – 3	0.4 – 3
Edge thickness, strips / solid strips (mm)	0.4 – 3	0.4 – 3	0.4 – 3	0.4 – 3	0.4 – 3	0.4 – 3
MISCELLANEOUS						
Feed speed (m/min)	8	8	8	8	8	8
Weight (kg)	700	750	900	950	900	1100
Pneumatic system (bar)	6	6	6	6	6	6
Electrics	Suitable for all types of power supply grid worldwide					

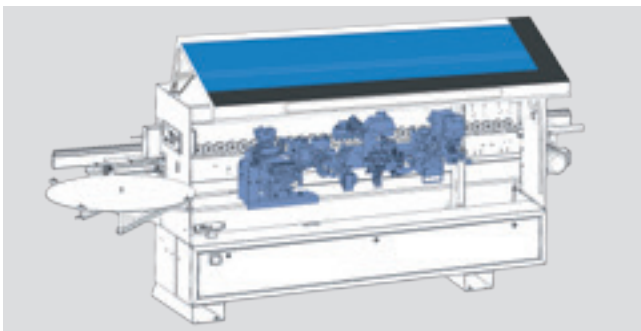

Model 1110

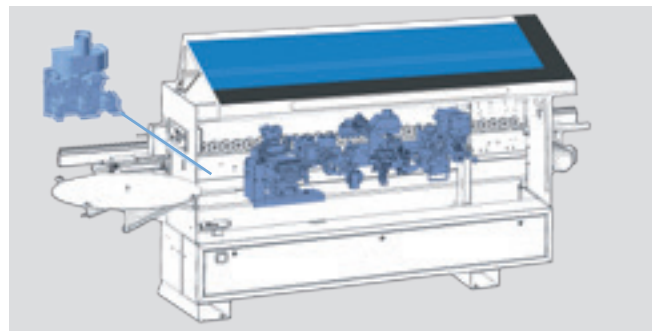

Model 1110 F

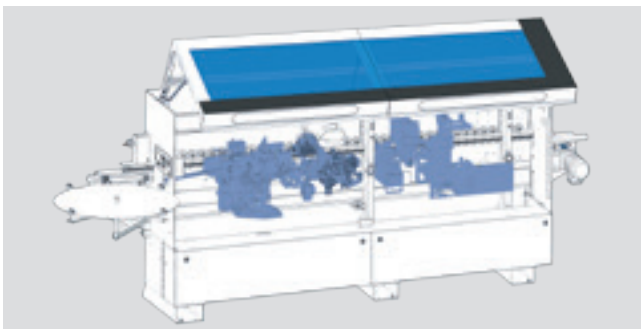

Model 1120 C

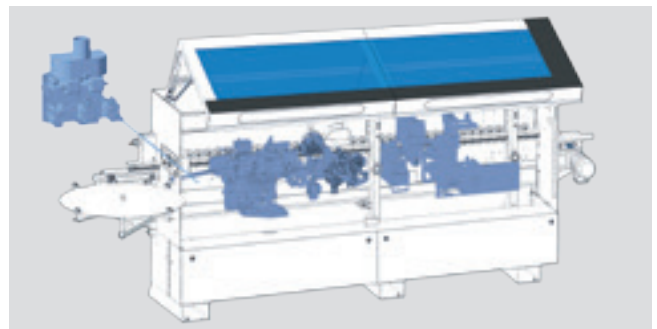

Model 1120 FC

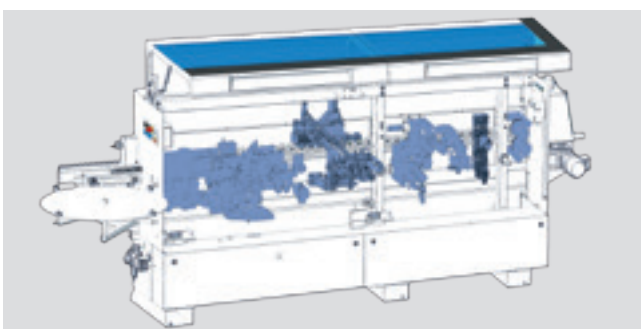

Model 1120 F

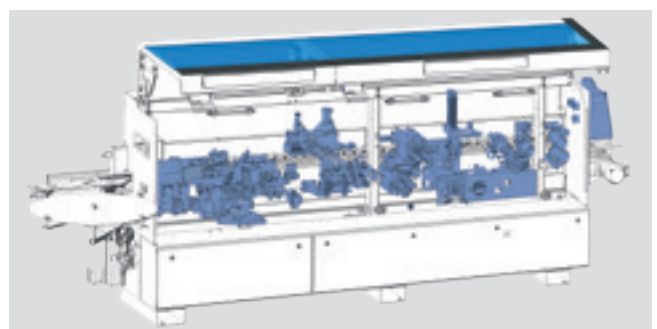

Model 1130 FC

TECHNICAL DATA EDGETEQ S-240 SERIES

MACHINE DIMENSIONS	Model 1210	Model 1210 F	Model 1220 C	Model 1220 FC	Model 1230 FC
Overall length (mm)	3,507	3,653	4,153	4,153	4,773
Working height (mm)	950	950	950	950	950
WORKING DIMENSIONS					
Workpiece width (mm)					
with workpiece thickness 8 – 22 mm	70	70	70	70	70
with workpiece thickness 23 – 50 mm	120	120	120	120	120
Workpiece thickness (mm)	8 – 50 (opt. 8 – 60)	8 – 50 (opt. 8 – 60)	8 – 50 (opt. 8 – 60)	8 – 50 (opt. 8 – 60)	8 – 50 (opt. 8 – 60)
Edge thickness, coils (mm)	0.4 – 3	0.4 – 3	0.4 – 3	0.4 – 3	0.4 – 3
Edge thickness, strips / solid strips (mm)	0.4 – 3	0.4 – 3	0.4 – 3	0.4 – 3	0.4 – 3
MISCELLANEOUS					
Feed speed (m/min)	11	11	11	11	11
Weight (kg)	910	1.080	1.240	1.290	1.500
Pneumatic system (bar)	6	6	6	6	6
Electrics	Suitable for all types of power supply grid worldwide				

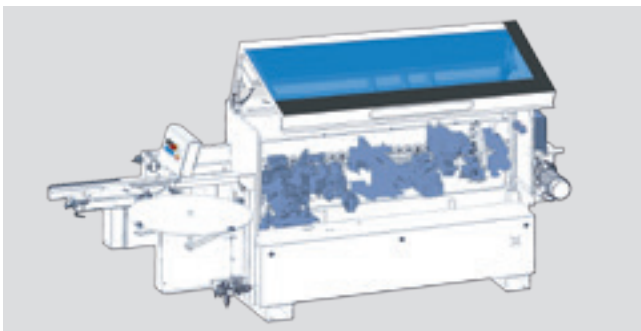

Model 1210

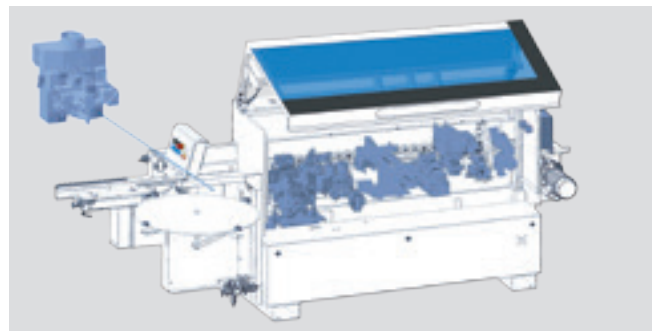

Model 1210 F

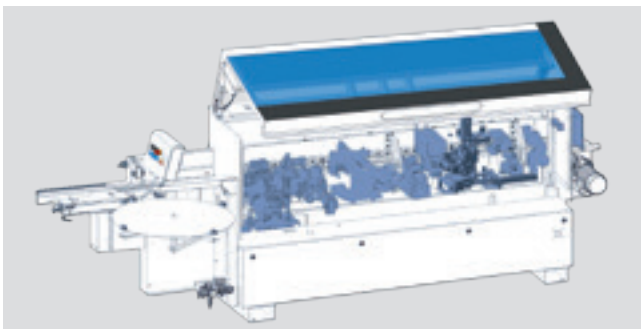

Model 1220 C

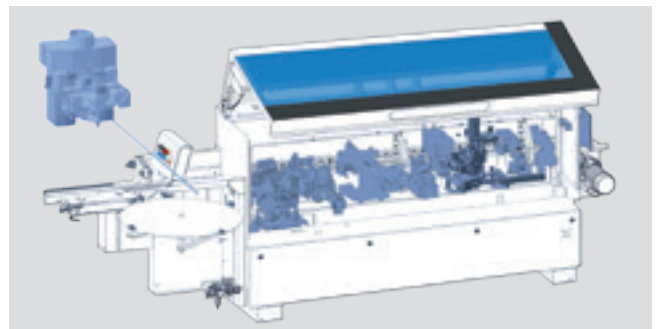

Model 1220 FC

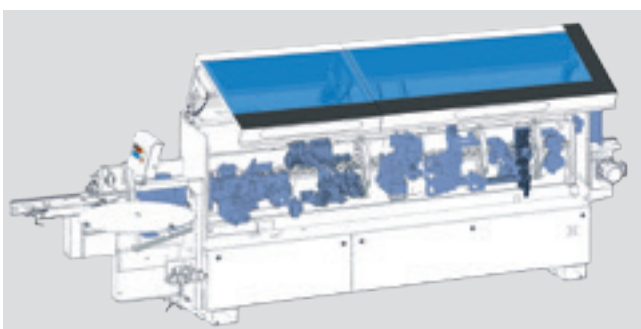

Model 1230 FC

TECHNICAL DATA EDGETEQ S-240 SERIES

MACHINE DIMENSIONS	Model 1210 HF	Model 1220 HF	Model 1230 HF	Model 1220 AT	Model 1230 AT
Overall length (mm)	3,653	4,153	4,773	4,469	5,070
Working height (mm)	950	950	950	950	950
WORKING DIMENSIONS					
Workpiece width (mm)					
with workpiece thickness 8 – 22 mm	70	70	70	70	70
with workpiece thickness 23 – 40 mm	120	120	120	120	120
with workpiece thickness 41 – 60 mm	150	150	150	150	150
Workpiece thickness (mm)	8 – 60	8 – 60	8 – 60	8 – 60	8 – 60
Edge thickness, coils (mm)	0.4 – 3	0.4 – 3	0.4 – 3	0.4 – 3	0.4 – 3
Edge thickness, strips / solid strips (mm)	0.4 – 6	0.4 – 6	0.4 – 6	0.4 – 6	0.4 – 6
MISCELLANEOUS					
Feed speed (m/min)	11	11	11	8	8
Weight (kg)	1,080	1,280	1,500	1,290	1,500
Pneumatic system (bar)	6	6	6	6	6

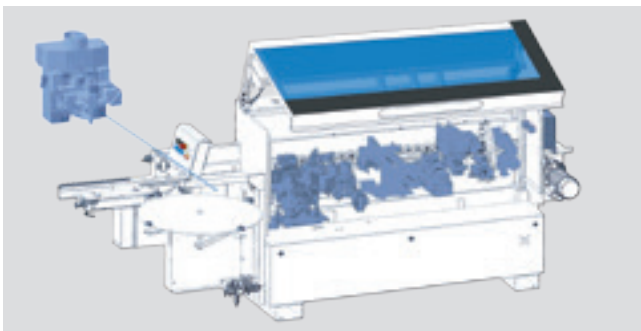

Model 1210 HF

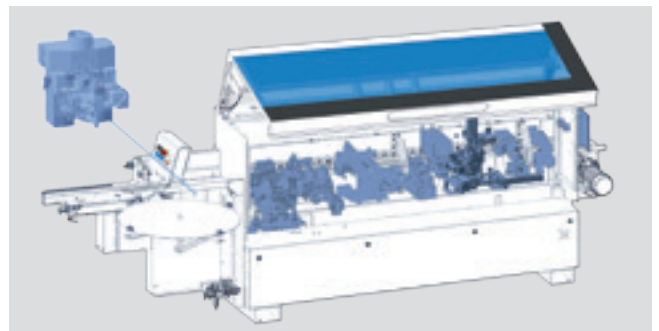

Model 1220 HF

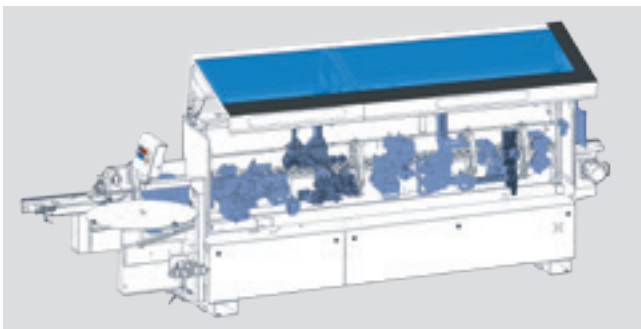

Model 1230 HF

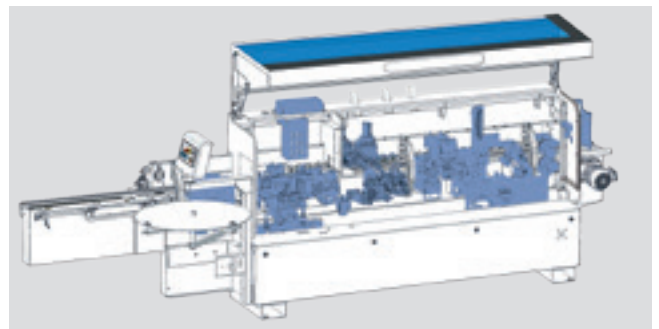

Model 1220 AT

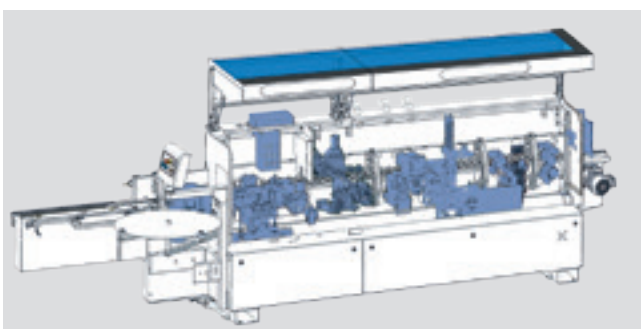

Model 1230 AT

TECHNICAL DATA FOR EDGETEQ S-300 SERIES

MACHINE DIMENSIONS	Model 1430 FC	Model 1440 FC	Model 1440 FGC	Model 1450 FC
Overall length (mm)	4,773	5,273	5,273	6,062
Working height (mm)	950	950	950	950
WORKING DIMENSIONS				
Workpiece width (mm)				
with workpiece thickness 8 – 22 mm	70	70	70	70
with workpiece thickness 23 – 40 mm	120	120	120	120
with workpiece thickness 41 – 60 mm	150	150	150	150
Workpiece thickness (mm)	8 – 60	8 – 60	8 – 60	8 – 60
Edge thickness, coils (mm)	0.4 – 3	0.4 – 3	0.4 – 3	0.4 – 3
Edge thickness, strips / solid strips (mm)	0.4 – 8	0.4 – 8	0.4 – 8	0.4 – 8
MISCELLANEOUS				
Feed speed (m/min)	8 – 14	8 – 14	8 – 14	8 – 14
Weight (kg)	1,600	1,850	1,850	2,250
Pneumatic system (bar)	6	6	6	6
Electrics	Suitable for all types of power supply grid worldwide			

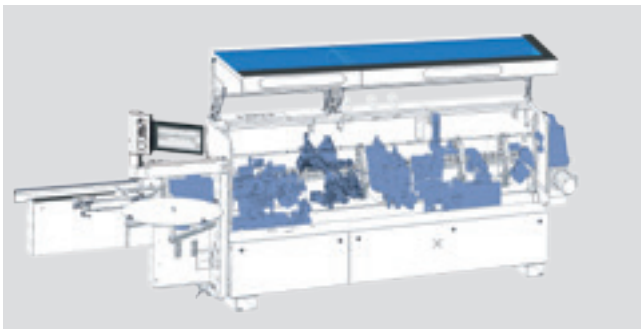

Model 1430 FC

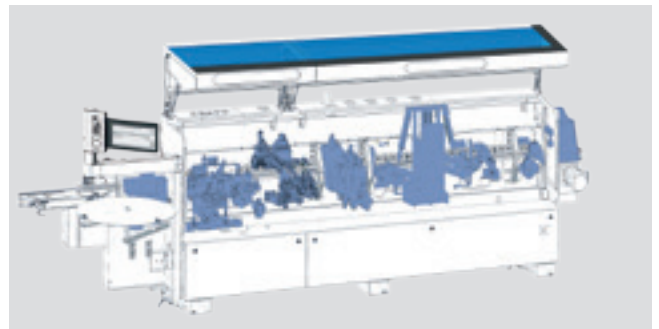

Model 1440 FC

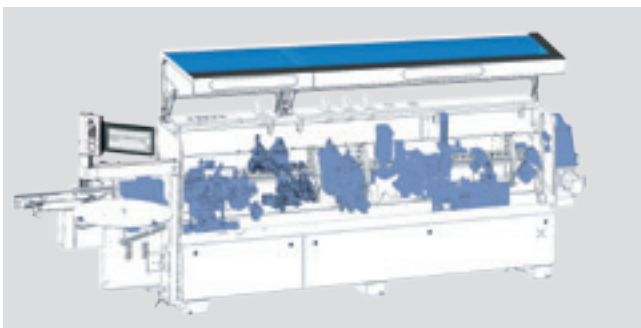

Model 1440 FGC

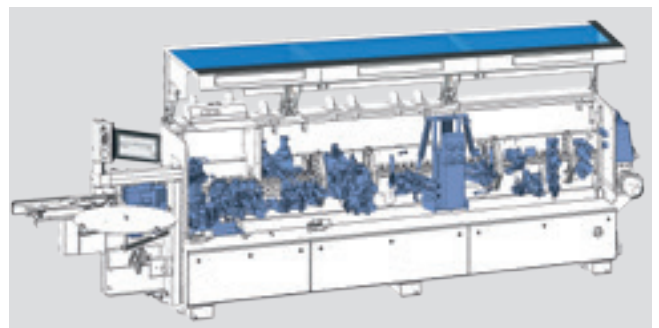

Model 1450 FC

TECHNICAL DATA FOR EDGETEQ S-300 SERIES

MACHINE DIMENSIONS	Model 1430 HF	Model 1440 HF	Model 1440 E	Model 1440 AT
Overall length (mm)	4,773	5,273	5,573	5,573
Working height (mm)	950	950	950	950
WORKING DIMENSIONS				
Workpiece width (mm)				
with workpiece thickness 8 – 22 mm	70	70	70	70
with workpiece thickness 23 – 40 mm	120	120	120	120
with workpiece thickness 41 – 60 mm	150	150	150	150
Workpiece thickness (mm)	8 – 60	8 – 60	8 – 60	8 – 60
Edge thickness, coils (mm)	0.4 – 3	0.4 – 3	0.4 – 3	0.4 – 3
Edge thickness, strips / solid strips (mm)	0.4 – 8	0.4 – 8	0.4 – 8	0.4 – 8
MISCELLANEOUS				
Feed speed (m/min)	8 – 14	8 – 14	8 – 14	8 – 14
Weight (kg)	1,600	1,850	1,850	1,850
Pneumatic system (bar)	6	6	6	6
Electrics	Suitable for all types of power supply grid worldwide			

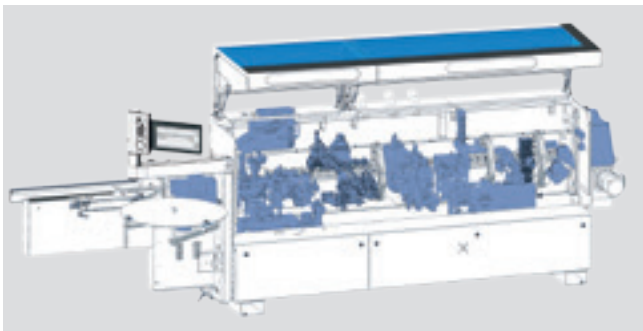

Model 1430 HF

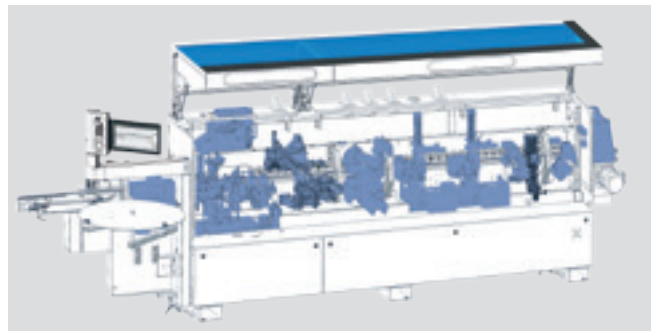

Model 1440 HF

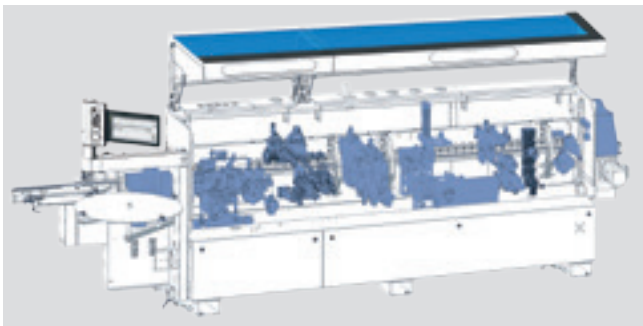

Model 1440 E

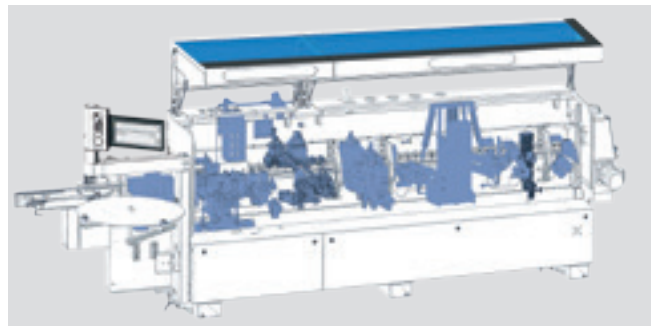

Model 1440 AT



The right machine for your requirements

The machines from the S-200 to S-300 series offer comprehensive solutions for the flexible and economical manufacture of your products. Whether living room, bedroom and kitchen furniture, functional office furniture, superior shopfitting solutions or batch size 1 production for individual

requirements — HOMAG offers a well designed product range to meet any requirement. Using these machines can also make current trends easily achievable for you and your employees.





LOOPTEQ O-200 return conveyor: Higher productivity for your HOMAG edge bander

As an indispensable assistant the return system renders your HOMAG EDGETEQ even more economic. With the one-man-operation you optimize the workpiece return and allow a lean and efficient production process.

Any combination of your HOMAG machine of the EDGETEQ S-300 series with this return system is provided. Ideally suited for customers with small, narrow, and medium-sized workpieces.

LOOPTEQ O-200

The entry to a comfortable material flow.

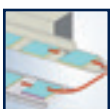

Your benefits at a glance

- **Fast amortization – pays off from 9 hours working time per week**
- **No training necessary – assemble the return conveyor, connect it, and get started**
- **Flexible operator organization – thanks to economic one-man operation**
- **Ergonomic working – manual parts handling is reduced to a minimum**
- **Improved quality control – rapid response to material adjustments**

TECHNICAL DATA	
LOOPTEQ O-200	
Workpiece length (mm)	300 – 2,500
Workpiece width (mm)	50 – 1,450
Workpiece thickness (mm)	8 – 60
4-SIDED PROCESSING*	
min. workpiece length (mm)	300 x 300
max. workpiece length (mm)	1,450 x 1,450
MISCELLANEOUS	
Workpiece weight (kg)	
Feed speed (m/min.)	max. 30
at length > 700 mm	max. 50
Feed speed (m/min)	8 - 25
Mass per unit area (kg / m ²)	25

*Larger workpieces can be returned or fed out at 4-sided processing with manual assistance during crosswise offset and turning.

by the way

The return conveyor already pays off within one year, in fact starting from an operation of 9 hours per week!



Sensor-controlled pivot pins (option)

For easier rotation of short and narrow workpieces.



CE Package

Safety engineering equipment. For the protection of the employees.

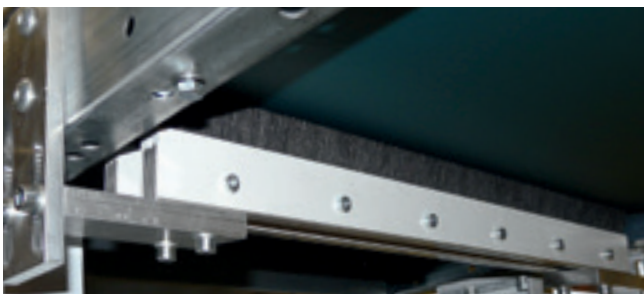

Belt cleaning

For optimal protection against dust and chips.



Remote control

Separate control panel at the infeed of the edge-banding machine.



HOMAG Life Cycle Services

The sale of our machines comes with all-in optimum service backup and individual advice. We support you with service innovations and products which are especially tailored to your requirements. With short response times and fast customer

solutions, we guarantee consistently high availability and economical production – over the entire life cycle of your machine.



Remote Service

- Hotline Support by remote service for control systems, mechanics and process technology, resulting in 85.2 % fewer on-site servicing callouts
- Mobile applications such as ServiceBoard reduce the costs through fast help in case of troubles by mobile live video diagnosis, online service message and the online spare parts shop eParts



Spare Part Service

- Round-the-clock identification, inquiries and direct ordering of spare parts at www.eParts.de
- Local availability of parts through sales and service companies, as well as sales and service partners all over the world
- Reduced downtimes due to defined spare part and wearing part kits



Modernization

- Keep your machinery up-to-date and increase your productivity as well as your product quality. to prepare yourself today for the product requirements of tomorrow
- We provide support in the form of upgrades, modernization, individual advice and development



HOMAG Finance
– precisely the right financing

- We offer you tailored financing proposals for your machinery or plants. Our advisory service goes hand in hand with our technical expertise over a wide range of issues. Your personal contact person will take care of the whole process.
- The benefit for you: The ability to invest without delay in new technologies and remain financially flexible.

1.200
Service employees around the world

650
processed spare parts orders / day

85,2%
less on-site-services through successful remote diagnosis

>150.000
machines electronically documented in eParts in 28 languages



Trainings

- Training tailored precisely to your requirements ensures the optimum operation and maintainance of your HOMAG machinery by your own machine operators
- Courses include customer-specific training documentation complete with practical training exercises.

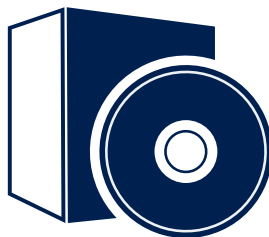

Software

- Telephone assistance and advice by Software Support
- Digitalization of your spare parts via 3D scanning saves time and money compared to new programming
- Subsequent networking of your machine outfit using smart software solutions from design through to production



Field Service

- Increase of machine availability and product quality by certified service staff
- Assurance of the highest quality of your products by regular checks through maintenance / inspection
- Minimized downtimes due to the ready availability of qualified technicians

HOMAG Group AG

info@homag.com

www.homag.com



YOUR SOLUTION