

AUTOMATIC WIDE BELT SANDER

*Proven technology for
your sanding
requirements.*



52RK

When jobs call for efficiency, accuracy and smooth sanding, Holytek's, new series of wide belt sanders are the perfect solution. These machines are designed and manufactured to deliver superior sanding performance, create an extremely fine finish, while encompassing a comprehensive range of safety guards for the machine and operator.

HOLYTEK

HOLYTEK

OUTSTANDING STANDARD

FEATURES:

RUGGED CONSTRUCTION

The heavy duty steel main frame has reinforcing steel ribs to minimize vibration, providing a stable, deflection free platform for the working groups.

ELECTRONIC BELT OSCILLATION

Reduces the use of expensive compressed air. The oscillation action emits minimal noise. The automatic cleaning function of the diodes ensures lasting reliability.

VARIABLE FEED SPEED

The most compatible combination of finish and production speed can be achieved on any material.

POWERFUL MOTORS

A well mounted heavy duty motor is standard equipment for each sanding group.

CONVENIENT CONTROLS

The large, color coded buttons are clearly identifiable, for easy set-up and start up. Amp meters for each motor are mounted together above the main control console to allow the operator to monitor the load on each sanding head.

SAFETY

The trip bar at the in-feed section and the large emergency stop buttons ensure immediate machine shutdown in an emergency.

HEAVY DUTY WORKING GROUPS

Precision designed and balanced, the heavy duty sanding heads deliver a vibration free sanding operation. The spring loaded hold-down rollers secure the work firmly as it passes under the sanding heads.

CONVENIENT BELT CHANGING

Clear access, a quick tension release function and guide shoes make belt changing operations quick and easy.



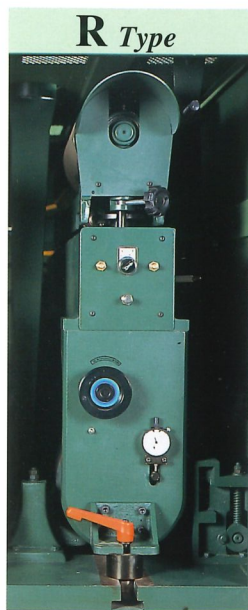

R Type

"R" TYPE SINGLE CONTACT ROLLER

For fast stock removal from calibrating with 36 to 50 grit, to intermediate finishing with 120 to 150 grit belts.

The large 250 mm diameter roller is rubber coated with helicoidal grooving. The rollers have been electronically balanced and rigidly mounted to ensure precision sanding results.

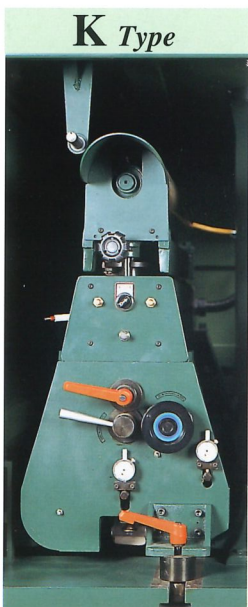
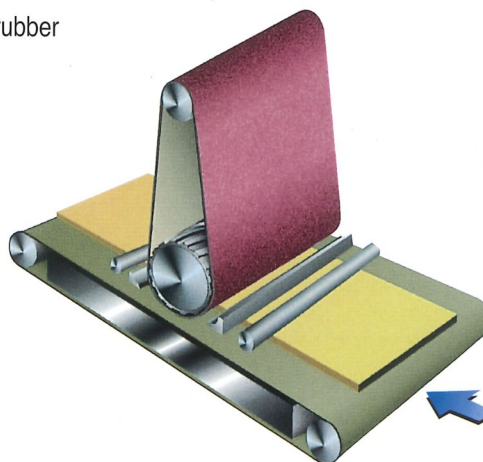

K Type

"K" TYPE COMBINATION ROLLER AND PLATEN

The 160 mm diameter contact roller precedes a flat platen in the single belt head. The platen produces a longer scratch pattern which improves the final finish.

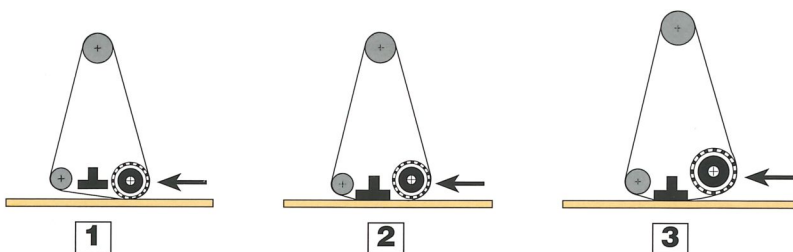
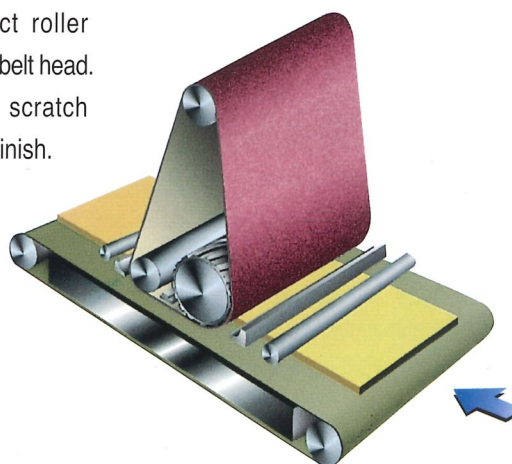

A choice of three operating modes ensures maximum versatility.

1. Platen up - the sander functions as a contact roller sander only when calibrated with 36 to 50 grit belts.
2. Roller and platen both down - intermediate and final finishing in one pass with 80 to 280 grit belts.
3. Platen down - final finish or lacquer sanding with 400 to 600 grit belts.



PNEUMATIC CENTERING OF THE CONVEYOR MAT.

Maintains constant tracking of the conveyor mat along the centre line of the feed table.

RK Type

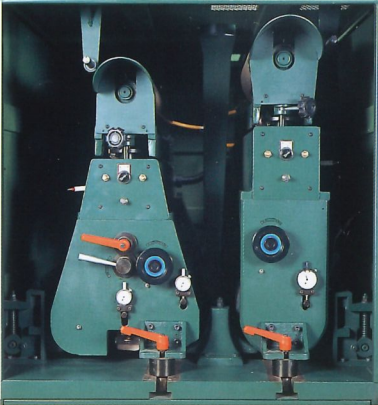

Type "RK" contact roller head followed by a combination of roller and platen head. Calibration and intermediate sanding, or intermediate and finish sanding in one pass.

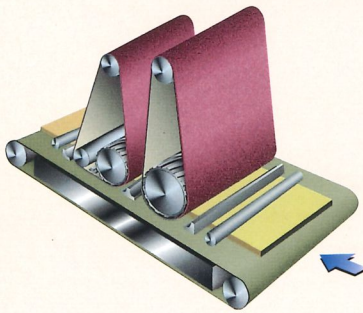

RRK Type

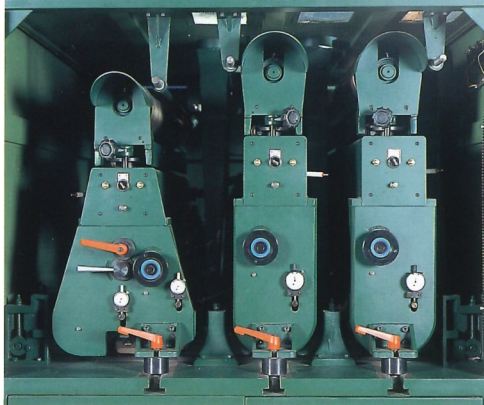

Type "RRK" Two contact roller heads followed by a combination of roller and platen head. Heavy calibration, intermediate sanding and fine finishing through three grit sizes in one pass. Reverse rotation selection on the second roller head increases the sanding smoothness on some materials. The ideal head configuration for panels, plywood and solid doors.

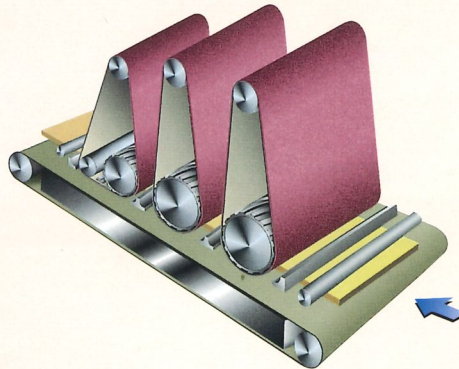

RKK Type

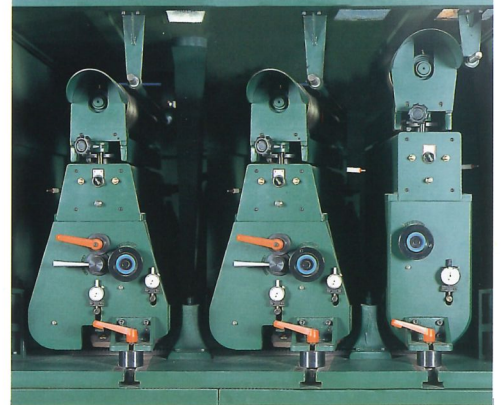

Type "RKK" roller head followed by two combination heads. This combination is most appropriate when the emphasis is more on fine finish sanding less on calibrating.

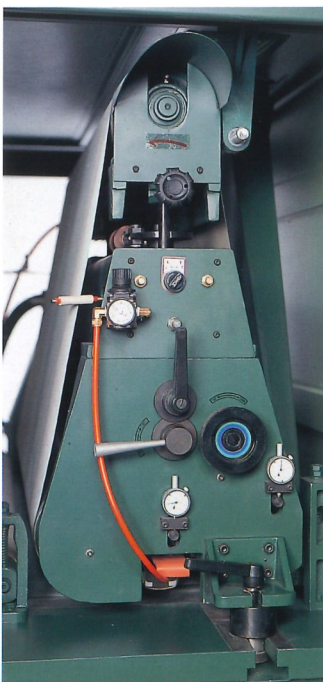
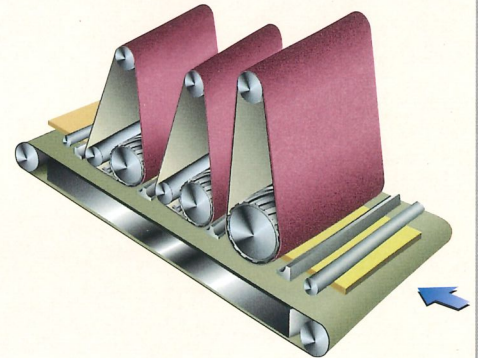

AIR PAD (OPTIONAL)

Allows the pad pressure to be instantly re-set for different materials. Hard for solid wood through to light pressure for fine finishing at higher feed speeds. No more time consuming pad changing.

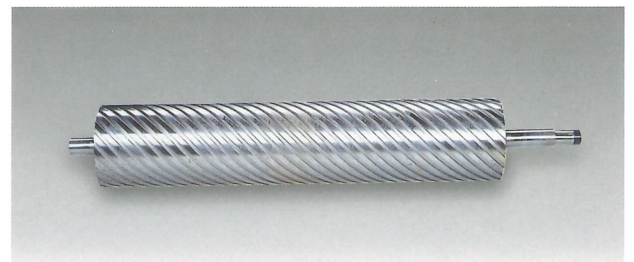

STEEL CONTACT ROLLER (OPTIONAL)

Ideal for consistent results even on hard wood and knotty timbers.

AIR JET CLEANER (OPTIONAL)

When operating the machine the oscillating air jet for cleaning the sanding belt and the speed can both be manually adjusted.

FLOATING TABLE (OPTIONAL)

This allows for a variety of material thicknesses to be fed at the same time, one after another. Maximum tolerance plus/minus 2 mm between pieces.

SPECIFICATIONS:

MODEL	25R	25K	37R	37K	25RK	37RK
Working width mm (inch)	609 (24")	609 (24")	914 (36")	914 (36")	609 (24")	914 (36")
Working height mm (inch)	127 (5")	127 (5")	127 (5")	127 (5")	127 (5")	127 (5")
Main motor standard HP	15	10	20	15	15, 10	20, 15
Maximum HP	20	20	20	20	20, 15	30, 20
Feed motor HP (KW)	2 (1.49)	2 (1.49)	2 (1.49)	2 (1.49)	2 (1.49)	3 (2.24)
Power rise and fail HP	1/2	1/2	1/2	1/2	1/2	1/2
Feed speeds (Variable) m/min (ft/min)	6-26 (19-85)	6-26 (19-85)	6-26 (19-85)	6-26 (19-85)	6-26 (19-85)	6-26 (19-85)
Standing belt dimension mm (inch)	635 x 1905 (25" x 75")	635 x 1905 (25" x 75")	939 x 1905 (37" x 75")	939 x 1905 (37" x 75")	635 x 1905 (25" x 75")	939 x 1905 (37" x 75")
Compressed air required at 5 atmos (CFM)	6	6	6	6	7	7
Exhaust volume requirement M3/Hr (CFM)	1030 (600)	1030 (600)	1720 (1000)	1720 (1000)	2064 (1200)	3500 (2000)
N.W. Kgs	1200	1200	1440	1440	2000	3200
G.W. Kgs	1500	1500	1850	1850	2450	3650
Dimensions: Length mm (inch)	1117 (44")	1117 (44")	1422 (56")	1422 (56")	1930 (76")	2006 (79")
Dimensions: Width mm (inch)	1422 (56")	1422 (56")	1524 (60")	1524 (60")	1701 (67")	1905 (75")
Dimensions: Height mm (inch)	2057 (81")	2057 (81")	2057 (81")	2057 (81")	2057 (81")	2057 (81")
Packing size cm	165 x 150 x 216	165 x 150 x 216	173 x 157 x 221	173 x 157 x 221	208 x 185 x 213	218 x 216 x 216

MODEL	43R	43K	52R	52K	43RK	52RK	43RRK	52RRK	43RKK	52RKK
Working width mm (inch)	1067 (42")	1067 (42")	1270 (50")	1270 (50")	1067 (42")	1270 (50")	1067 (42")	1270 (50")	1067 (42")	1270 (50")
Working height mm (inch)	127 (5")	127 (5")	127 (5")	127 (5")	127 (5")	127 (5")	127 (5")	127 (5")	127 (5")	127 (5")
Main motor standard HP (max.)	30 (40)	20 (30)	30 (50)	20 (30)	30, 20 (40, 25)	30, 20 (50, 30)	40, 30, 20	40, 30, 20	40, 30, 20	40, 30, 20
Feed motor HP (KW)	3	3	3	3	3	5	5	7 1/2	5	7 1/2
Power rise and fail HP	1/2	1/2	1/2	1/2	1/2	1	1	1	1	1
Feed speeds (Variable) m/min	6-26	6-26	6-26	6-26	6-26	6-26	6-26	6-26	6-26	6-26
Standing belt dimension mm (inch)	1092 x 2134 (43" x 84")	1092 x 2134 (43" x 84")	1320 x 2134 (52" x 84")	1320 x 2134 (52" x 84")	1092 x 2134 (43" x 84")	1320 x 2134 (52" x 84")	1092 x 2134 (43" x 84")	1320 x 2134 (52" x 84")	1092 x 2134 (43" x 84")	1320 x 2134 (52" x 84")
Compressed air required at 5 atmos (CFM)	6	6	7	7	7	7	7	7	7	7
Exhaust volume requirement M3/Hr (CFM)	2600 (1500)	2600 (1500)	3500 (2000)	3500 (2000)	5180 (3000)	6860 (4000)	7760 (4485)	9870 (5600)	7760 (4485)	9870 (5600)
N.W. Kgs	2200	2200	2500	2500	4000	4700	4485	5050	5100	5350
G.W. Kgs	2500	2500	2800	2800	4500	5200	4850	5850	4850	5880
Dimensions: Length mm (inch)	2489 (98")	2489 (98")	2718 (107")	2718 (107")	2489 (98")	2718 (107")	2489 (98")	2718 (107")	2489 (98")	2718 (107")
Dimensions: Width mm (inch)	1778 (70")	1778 (70")	1778 (70")	1778 (70")	2235 (88")	2235 (88")	2616 (103")	2616 (103")	2100 (118")	2100 (118")
Dimensions: Height mm (inch)	2100 (80")	2100 (75")	2100 (80")	2100 (75")	2100 (75")	2100 (80")	2100 (80")	2100 (80")	2100 (80")	2100 (80")
Packing size cm	259 x 188 x 226	259 x 188 x 226	277 x 188 x 226	277 x 188 x 226	259 x 213 x 226	277 x 226 x 226	288 x 226 x 226	295 x 226 x 226	288 x 226 x 226	295 x 226 x 226

* All specifications, dimensions and design characteristics shown in this catalogue are subject to change without notice.

MODEL	STANDARD TYPE	OPTION TYPE
1. AIR PAD		25 37 43 52
2. DIGITAL READOUT	43 52	25 37
3. AIR JET CLEANER		25 37 43 52
4. BRUSHING ROLLER	43 52	25 37
5. STEEL CONTACT ROLLER		25 37 43 52
6. THICKNESS CONVEYER BELT	25 37 43 52	

ALL NEW SANDING CAPABILITY FROM HOLYTEK FINAL & IRREGULAR SANDING MACHINE

Designed for solving final & irregular sanding problems easily and quickly.

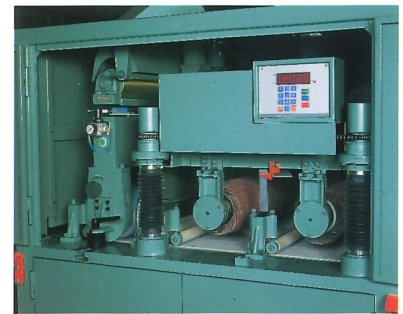

DOUBLE BRUSHING BELT (OR SANDING WHEEL) & SOFT CONTACT DRUM BELT SYSTEM



FREQUENCY INVERTER

All systems are provided with a frequency inverter for variable speed control to match a variety of working needs.

DESIGN FEATURES:

- With double brushing belt (or sanding wheel) can run in reverse or inverse to each other. The digital readout control system allows the belt to be raised or lowered independently.
- The third contact sanding drum has a soft spiral rubber roller for final sanding of flat panels.
- Standard digital readout of height setting.
- A soft brushing roller (or buffing cloth) for cleaning after the last contact drum. The air-jet cleaner is standard.

APPLICATIONS:

- SURFACE AND LACQUERED PANEL SANDING
- BURR AND PROFILE EDGE CLEANING
- IRREGULAR SURFACE SANDING (CABINET PANELS, WINDOWS FRAMES & SOLID DOOR PANELS ETC)

SPECIFICATIONS:

MODEL	600 SSB	900 SSB
Max. working width	600 mm (24")	900 mm (36")
Max. working thickness	125 mm (5")	125 mm (5")
Main motor	2HP x 2, 5HP w/Inverter x 2	3HP x 2, 7,5HP w/Inverter x 2
Feeding motor	2HP	3HP
Table hoist motor	1/2 HP x 2	1/2 HP x 2
Brushing motor	1/2 HP	1/2 HP
Sanding belt size	25" x 60"	36" x 60"
Packing size	257 x 148 x 199 cm	260 x 183 x 206 cm
N.W./G.W.	1700 / 1900 Kgs	2000 / 2300 Kgs

* All specifications, dimensions and design characteristics shown in this catalogue are subject to change without notice.

HOLYTEK

HOLYTEK INDUSTRIAL CORP.

9F-I, N O. 400, SEC. I, CHANG PING RD., TAICHUNG, TAIWAN, R.O.C.
TEL: 886-4-2452818 (REP.) FAX: 886-4-2436928

CAT NO:150397