

FORMULA

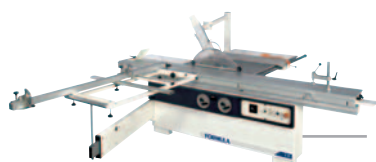

Circular saws

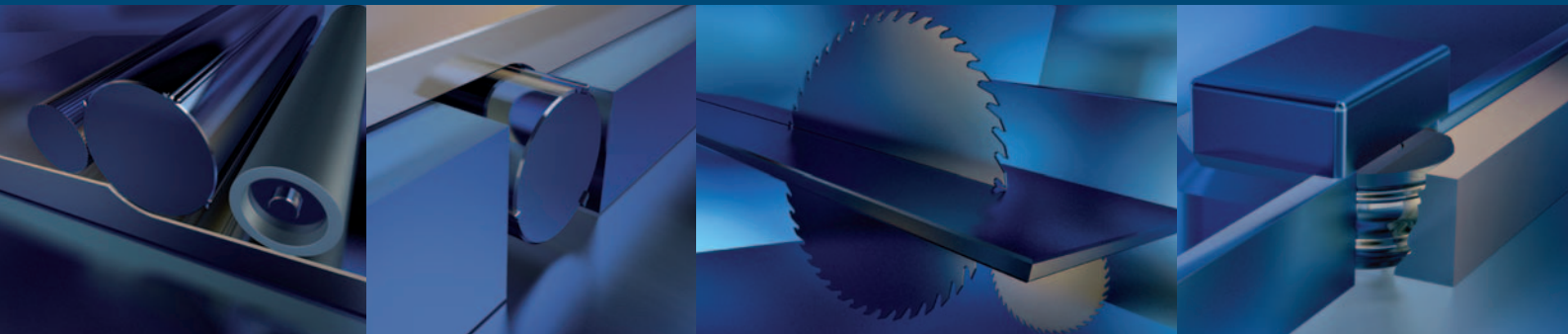

Surface planers



Thicknessing planers



Combined planer-thicknesser machines



Spindle moulders with fixed or tilting spindle

FORMULA

100% made in Italy

A product range of SCM Group

FORMULA - The best value for your investment

The **Formula** line is the new, bigger range of professional wood-working machines, for use in small- or medium-sized workshops. The technic and technologic solutions took by **Formula** derive directly from machines of higher brand: this assures performances, functionality, quality and user-friendliness.

The range includes planers and thicknessers, combined planer-thicknesser, spindle moulders with fixed or tilting spindles and circular saws.

Formula machines are available at a competitive price, and thanks to the various optional features, can be configured to suit most professional requirements.

FORMULA - The certainty of being part of a great industrial group

Formula is an **SCM** group brand. The 50 years of success enjoyed by this leading company bring unique advantages.

All this means for the customer:

- Reliable solutions
- Prestige
- An after sales service always close to the customer



SINERT



SISTEMA
DI GESTIONE
CERTIFICATO
REG. N. 091/C
UNI EN ISO 9001:2000

Formula **S30 S40 S40M** circular saws

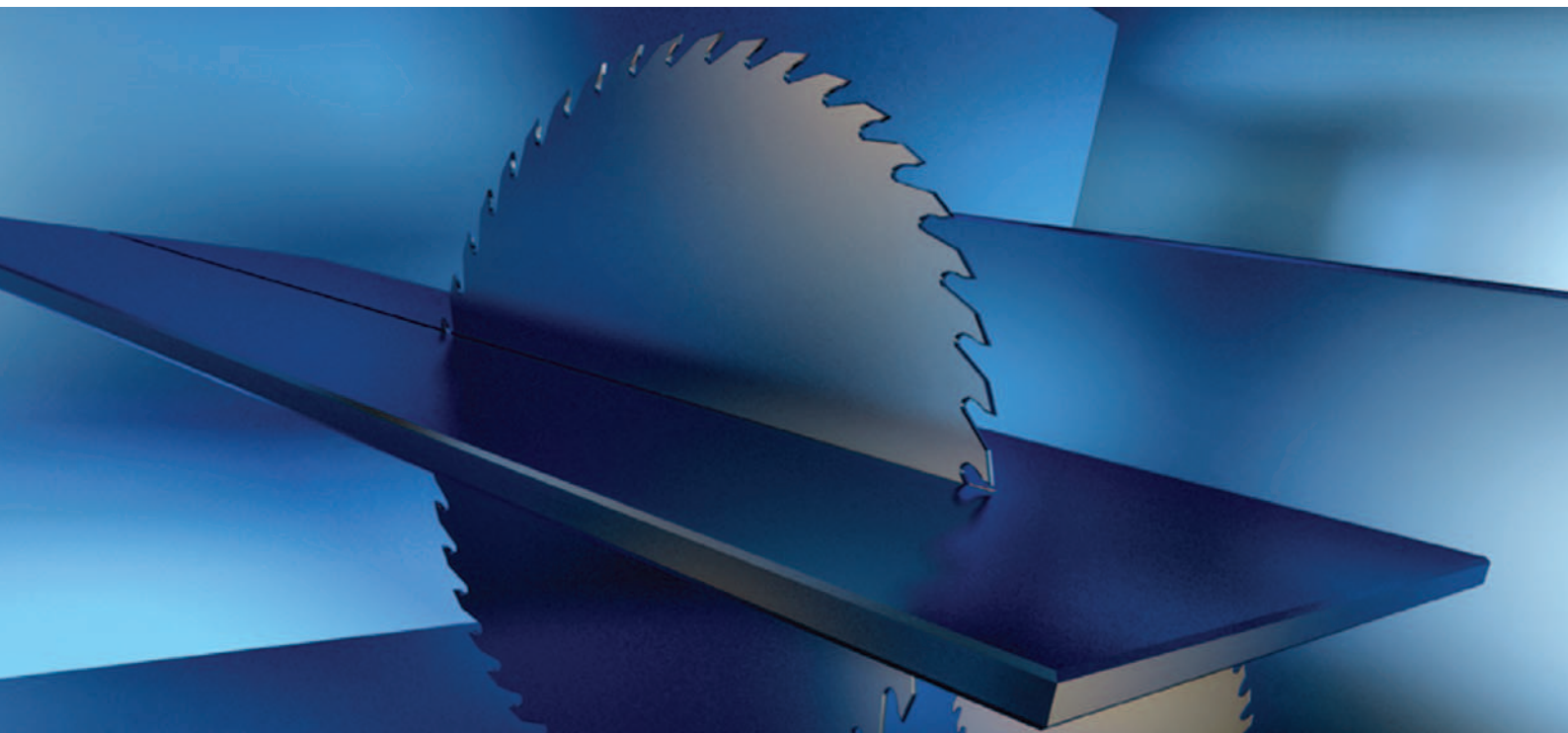

The operators, in order to obtain a high quality finished product, require a machine enabling them to work efficiently, comfortably and precisely. Formula provides all this. Each machine is fitted with exclusive solutions designed specifically for this purpose. The carriage slides very smoothly, the saw unit has the same features as an automatic panel saw and the unit is easily adjusted from the front of the machine.

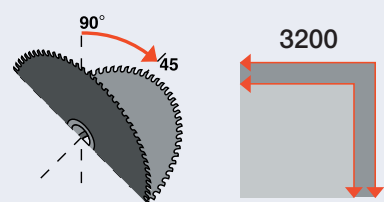
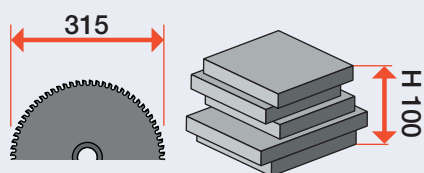

S30

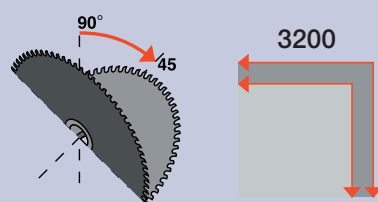
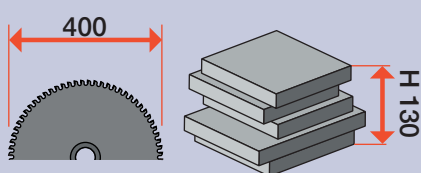

S40

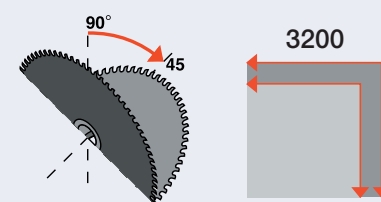
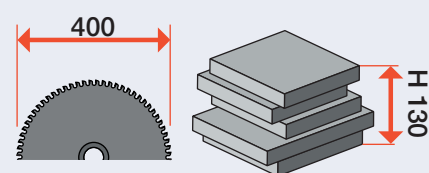

S40M (powered)

Formula **S30 S40 S40M** circular saws

A perfect cut at all time!



Frontal group movement

Standard saw-table extension on all versions

Telescopic squaring rule complete with two reversible stops

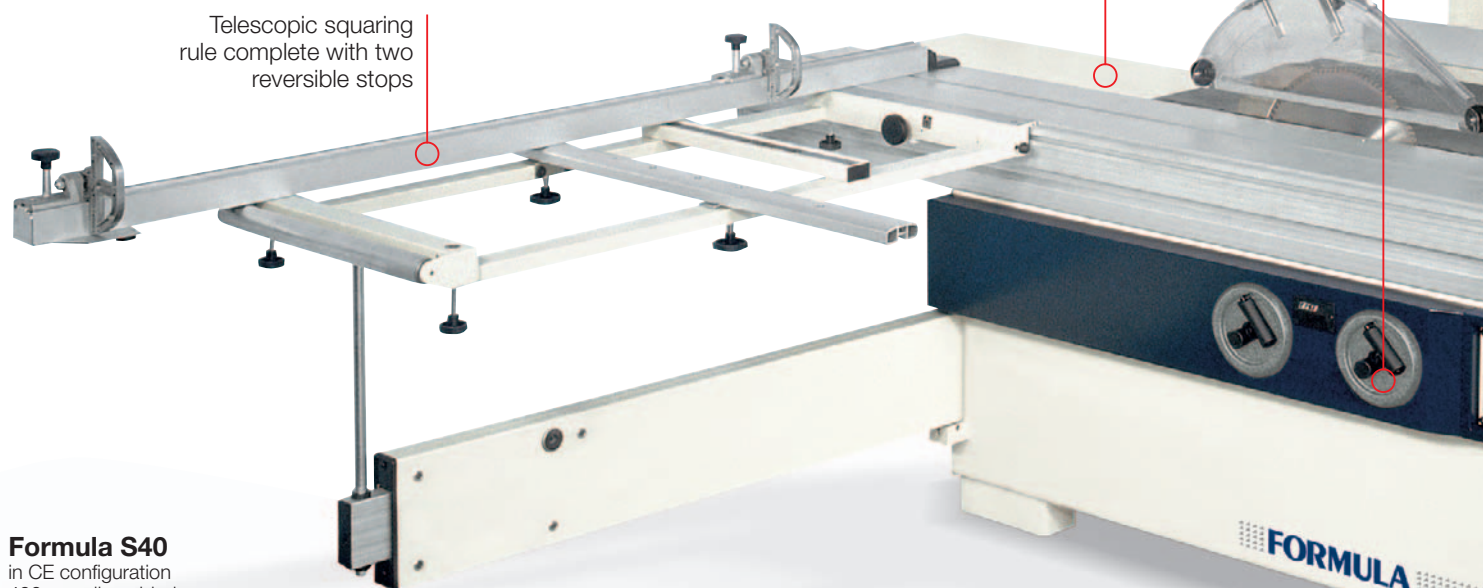

Formula S40
in CE configuration
400 mm diam. blade
130 mm cutting height
with motorized parallel fence and
electronic positioning (optional)

FORMULA



Formula S30
 in CE configuration
 315 mm diam. blade
 100 mm cutting height



Formula S40M
 in CE configuration
 400 mm diam. blade
 130 mm cutting height
 with electronic readout for rip fence
 position (optional)

Anodized aluminium rip fence with
 cutting capacity up to 1270 mm
 (1500 optional)

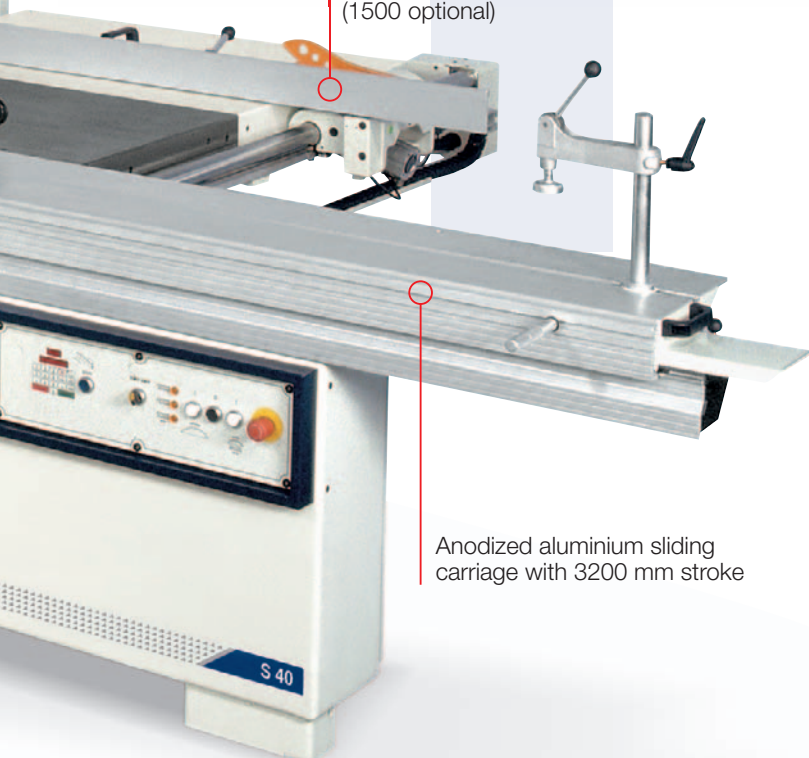

Anodized aluminium sliding
 carriage with 3200 mm stroke



S40M control panel with switches for saw unit lifting and
 tilting and electronic digital readouts

The quality showed in the details

Saw unit

A large structure, an hardened cast iron worktable and an innovative operator unit prevent vibration to ensure excellent finishing. Height adjustment using rounded guides ensures smooth operation even after years of use. All controls are located at the front of the machine for easy access and to ensure further time savings in the preparation process.

Scoring unit adjustment

The scoring unit is moved vertically and horizontally using a lever system to ensure the complete absence of play. This system also enables rapid positioning thus limiting the need for sawing tests.

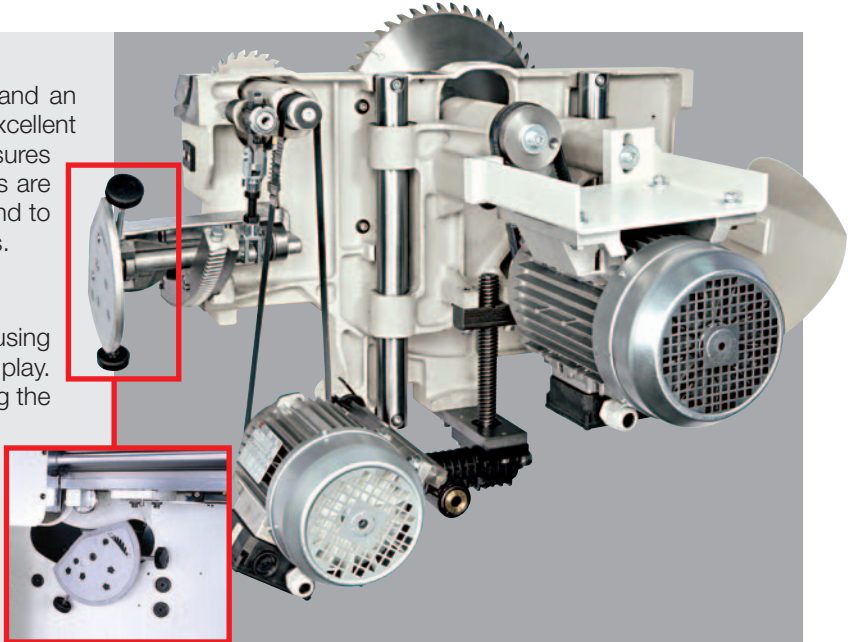

Carriage

Above all the carriage must slide easily and ensure precision and durability. Formula circular saws are fitted with an exclusive sliding system. Sturdy aluminium profiles with hardened steel guides fitted using rivets enable straight line precision of ± 0.05 mm along the entire length of the carriage. The result is considerable: the same precision after years of intensive use without maintenance.

5 year warranty

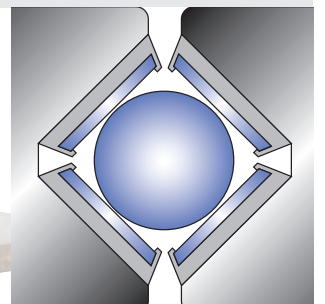

Exclusive system!

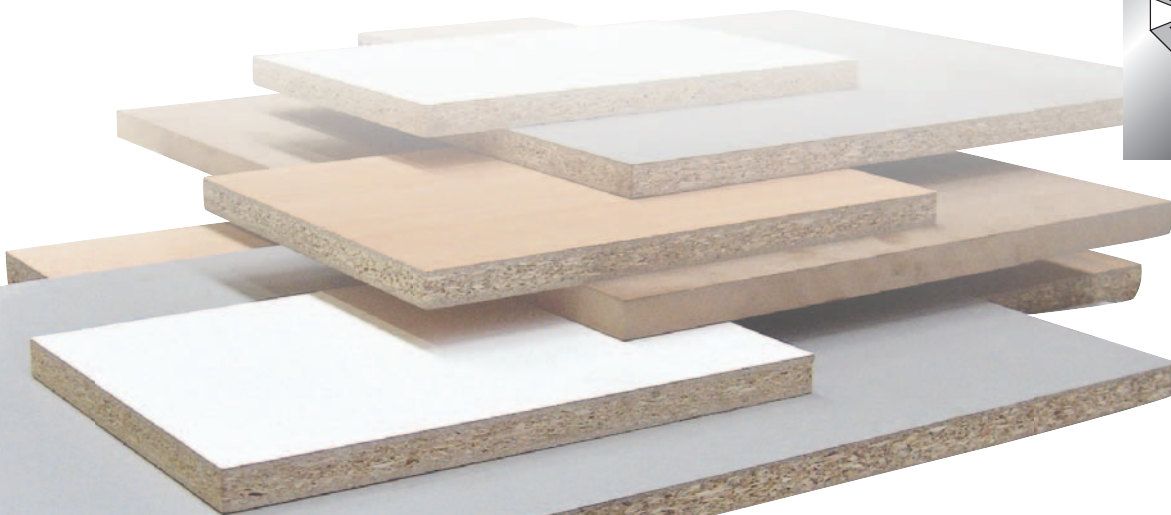

Formula S30 S40 S40M

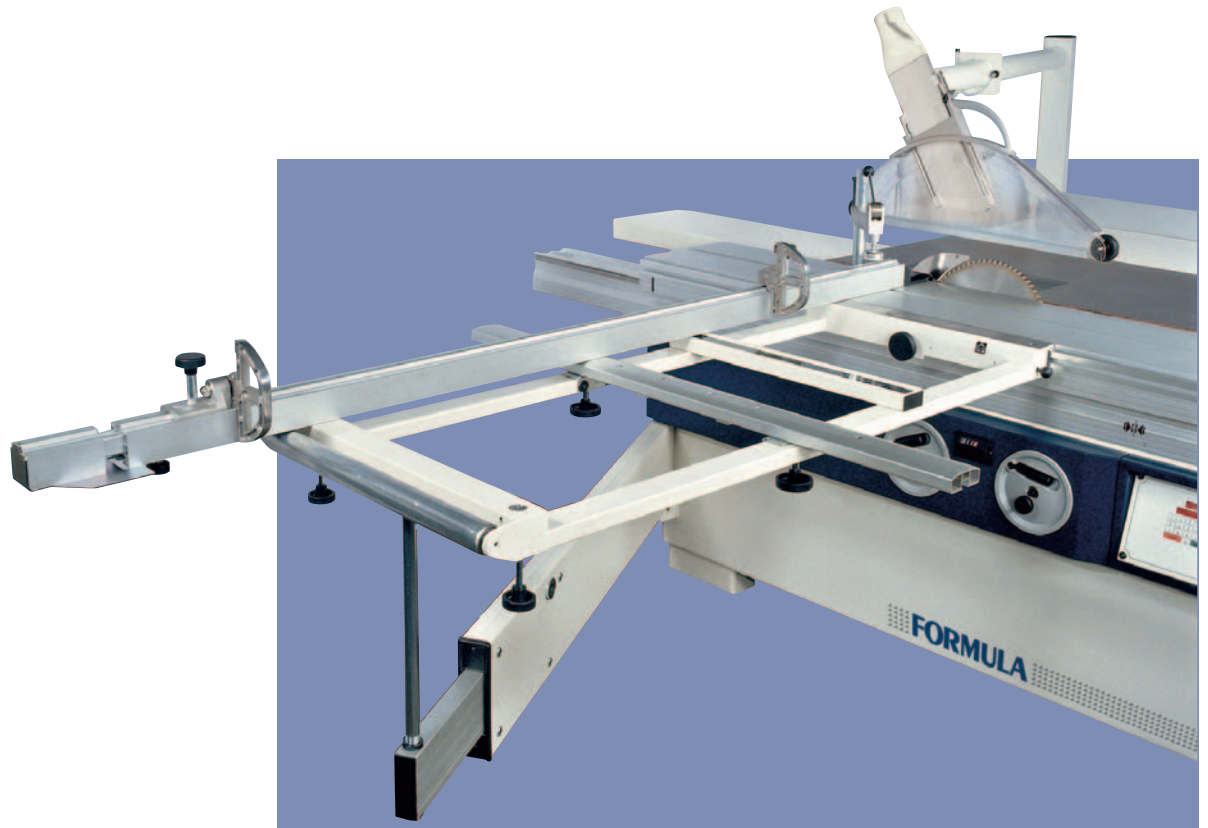

Squaring unit frame

Large design enables squaring of panels up to 3200 x 3200 mm.

It is fitted with a straight line guide complete with two reversible stops and an idle roller to facilitate the loading of large panels. The straight line guide also enables angular cutting up to 45°.



Main options available on request



Angular cutting device equipped with:
- telescopic fence with two flip-over stops
- pre-set for angle selection



Angular cutting device with automatic stop position compensation relative to the blade. Each time the cutting angle is adjusted so that the distance between the stop and the blade remains constant. This enables rapid set-up and reduces test cutting.

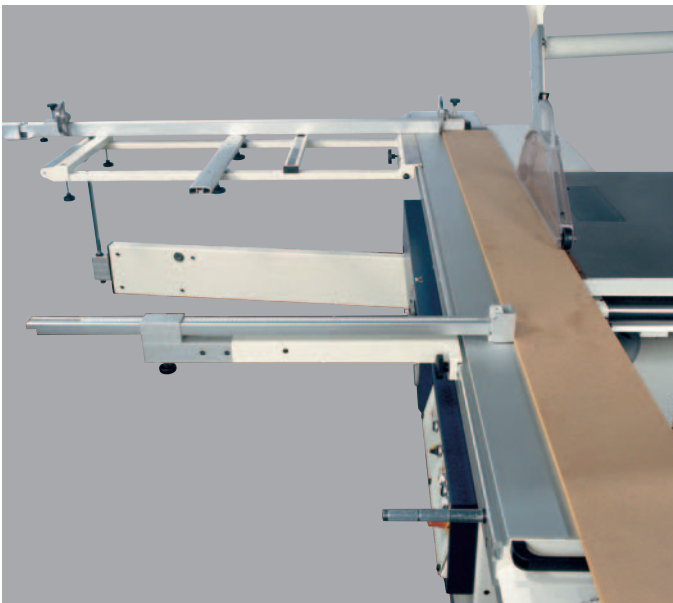

Rip cuts unit
Particularly useful with trim cuts on long pieces.



Suspended blade guard
Fitted in a tilted position to increase the useful cutting width to the parallel guide. An elegant solution for maximum flexibility.

Standard on S40 and S40M in CE version
Optional on S30

Formula **S30 S40 S40M**

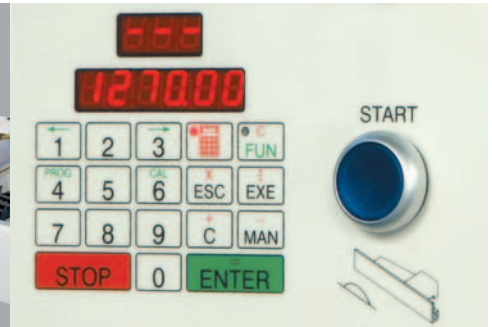

Motorized parallel fence with electronic positioning

Easy and precise positioning from numeric keyboard: by pushing a button the fence rapidly reach the requested position which is visualized on the electronic display.

For S40 and S40M only



Electronic readout for rip fence position

System for reading the current fence position from a magnetic band. Relative and micrometric adjustments are also possible.

For S40 and S40M only



Three saw blade rotating speeds

The speed change can be made easily from the opening on the worktable.

Standard on S40M
Optional on S40

Technical details



		S30	S40	S40M
Cutting capacity	mm	3200	3200	3200
Stop on fence for cuts extendable to	mm	3200	3200	3200
Standard cutting width with rip fence	mm	1270	1270	1270
Main blade diameter (hole)	mm	315 (30)	400 (30)	400 (30)
Scoring blade diameter (hole)	mm	120 (20)	120 (20)	120 (20)
Max. blade cutting height at 90°	mm	100	130	130
Max. blade cutting height at 45°	mm	70	92	92
Blade speed rotation	rpm	4000	3700	3000/4000/5000
Scoring blade speed rotation	rpm	8500	8500	8500
Blade tilting	degrees	90/45	90/45	90/45
Diameter of exhaust outlet at base	mm	120	120	120
Blade protection with exhaust outlet diameter (CE)	mm	60	60 (CE 80)	60 (CE 80)

Electrical features and Options

3x400V	●	●	●
5,5HP (4kW) direct start	●	-	-
7,5HP (5,5kW) direct start	○	●	●
10HP (7,5kW) automatic star-delta start	-	○	○
Saw unit powered lifting and tilting	-	-	●
Automatic brake on main saw blade motor	○	● (○ - no CE)	● (○ - no CE)
Angular cutting device	○	○	○
Angular cutting device with self-adjustment of the stop position	○	○	○
Rip cuttings device	○	○	○
Over head saw guard	○	● (○ - no CE)	● (○ - no CE)
Cutting width of the parallel fence 1000 mm	○	○	○
Cutting width of the parallel fence 1500 mm	○	○	○
3 rotation speeds of the main blade 3000-4000-5000 rpm	-	○	●
Electronic readout for the parallel fence position	-	○	○
Motorized parallel fence with electronic positioning	-	○	○

● = standard ○ = optional

S30 - S40 - S40M

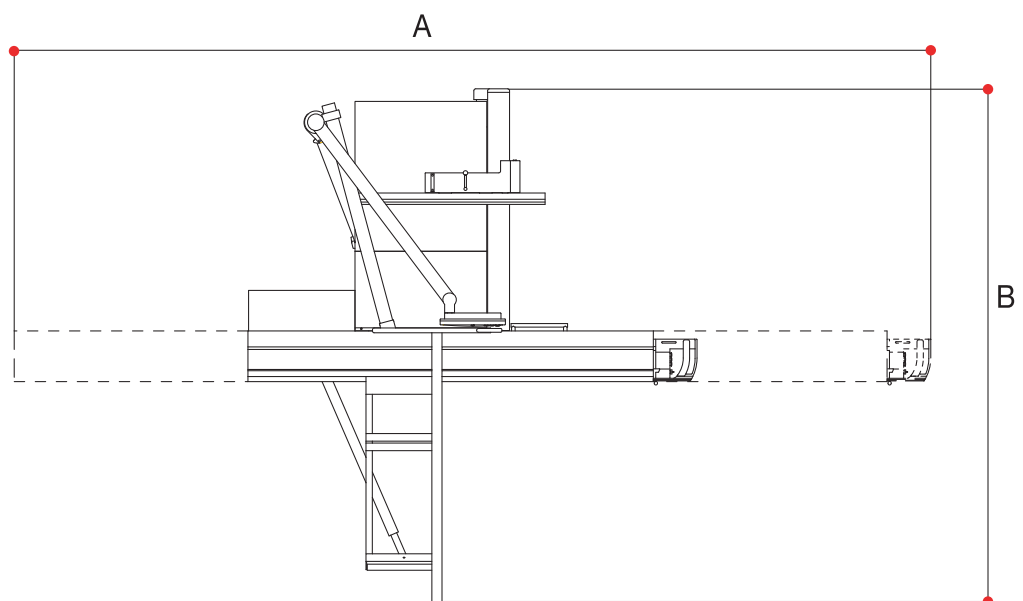

With carriage	A
3200 mm	7250 mm

Cutting width with parallel fence	B
1000 mm	4780 mm
1270 mm	5050 mm
1500 mm	5280 mm

Formula F1 F2

Surface planers

Formula SP1 SP2

Thickening
planers

Formula FS1 FS2

Combined
planer-thicknesser
machines

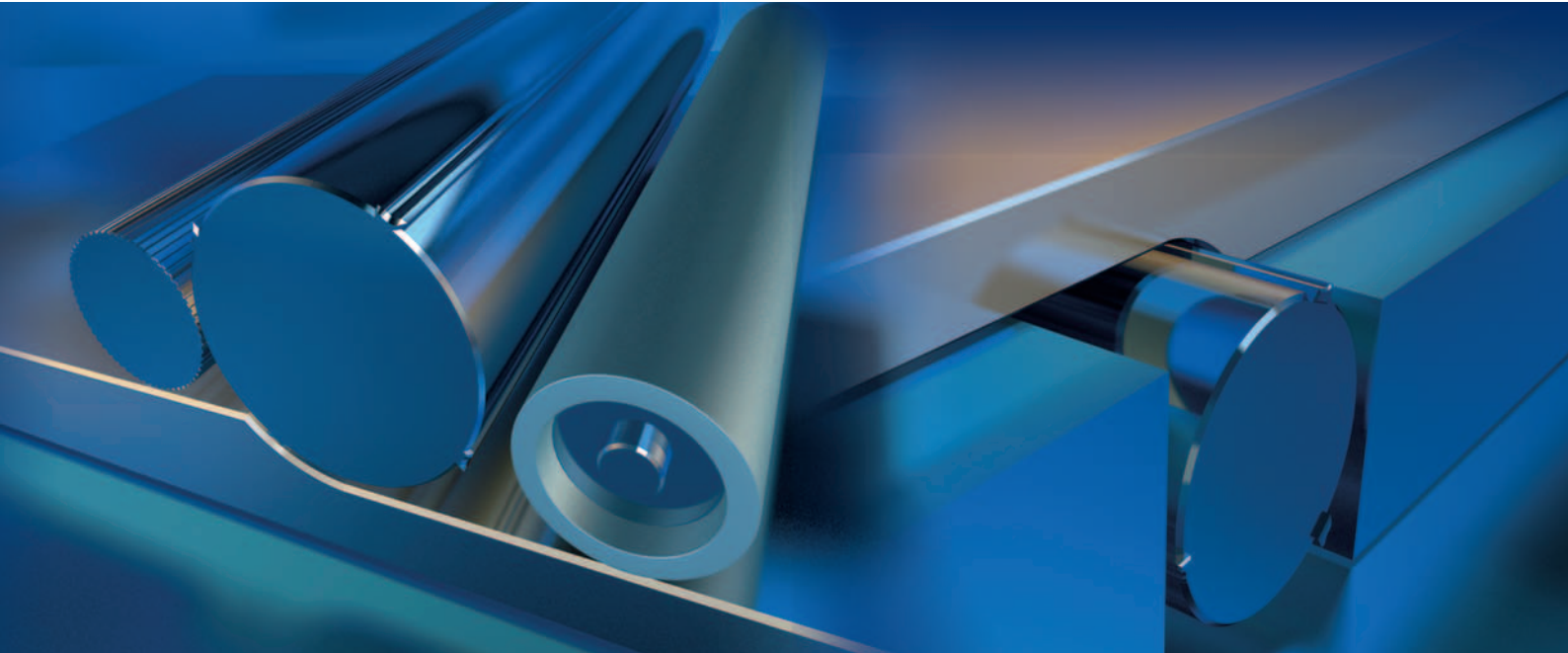

Planing has always been one of the principal processes where the machining of solid wood is concerned. The basic principle has remained the same but great advances have been made in the technology involved. Formula series planers are backed by our long-experience in woodworking machinery and feature innovative design solutions based on simple yet effective principles. Long, ribbed cast-iron worktables. A robust cutter block unit. Precision control and adjustment mechanisms. These are just three of the machine features designed with one thing in mind: to produce products with a high-quality finish.

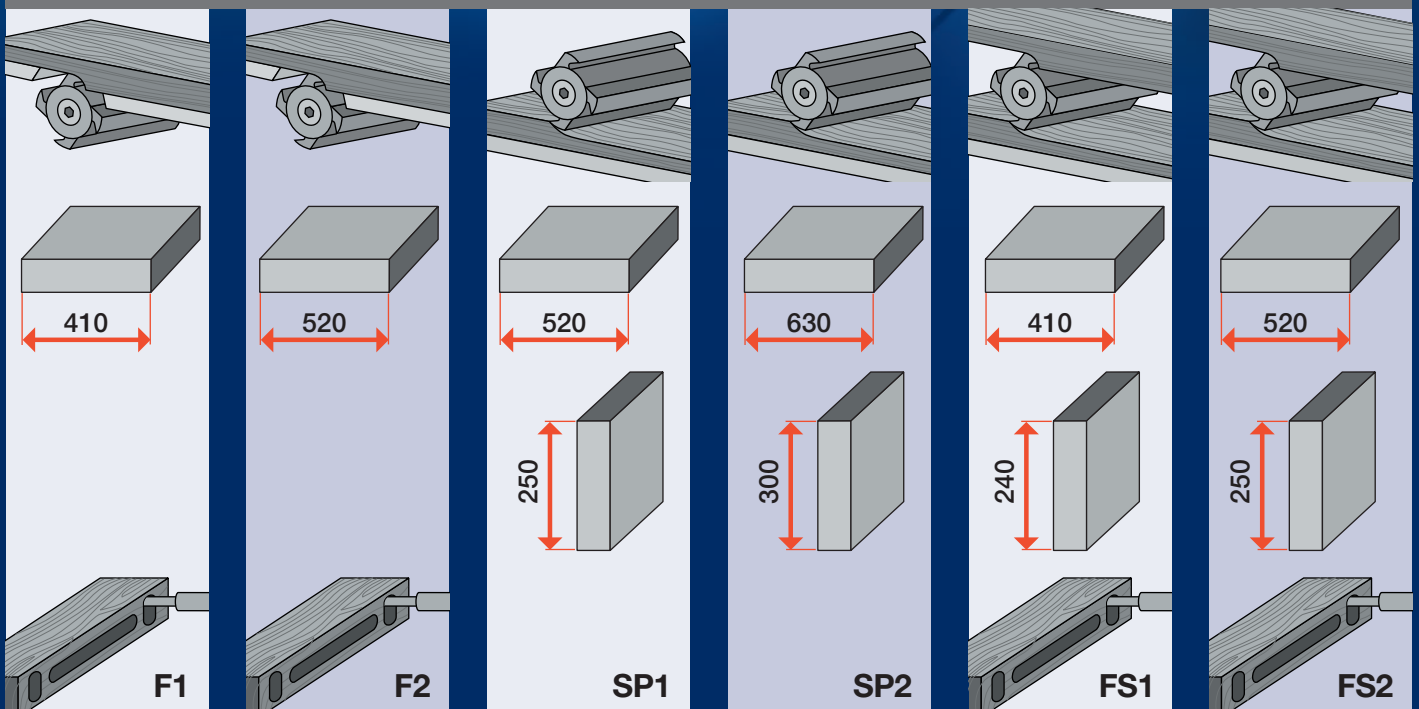

Formula **F1** **F2** Surface planers

Both models feature long, cast-iron worktables and a large anodised aluminium fence. An optimum high-quality finish is guaranteed even on large-size workpieces.



F2 in CE configuration

Formula F1 F2



F1 in CE configuration

The worktables are made from cast-iron and have a ribbed structure for greater strength and rigidity. The worktables are mounted on a parallelogram linkage mechanism which guarantees a constant distance between the worktable and the cutter block. This enables quick and easy adjustment of stock removal rates.

The planer block unit is designed to guarantee a top class finish. The cutter block has four knives and is mounted on a heavy, cast-iron structure providing the necessary strength, rigidity and absence of vibration. Cutter blocks are also available with the "Tersa" disposable knife option, a feature designed to cut setup times to the absolute minimum.



Planing fence

The fence is mounted on a precision mechanism enabling accurate angle adjustment from 90° to 45°.

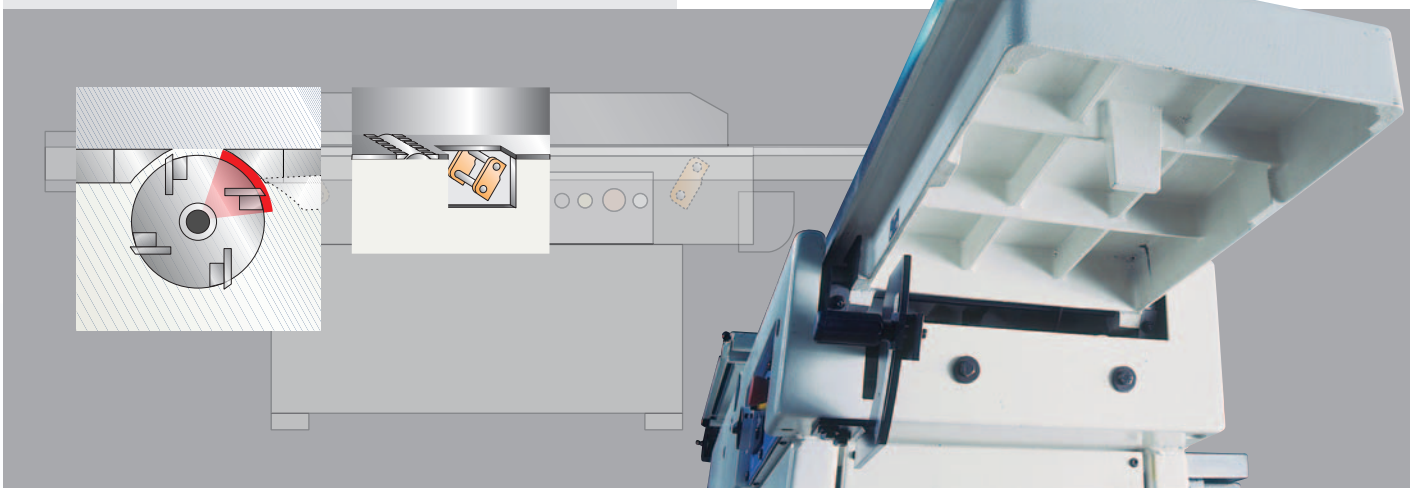

Formula **SP1 SP2** Thicknessing planers

Formula series thicknessers are renowned for their strength. The machining unit with a four-knife cutter block guarantees a high-quality finish. An infeed roller with helical grooving and a rubber coated outfeed roller ensure efficient, smooth workpiece feed.



SP2 in CE configuration

Formula **SP1** **SP2**



SP1 in CE configuration

Controls

All the controls are in an ergonomic position on the front of the machine. The feed speed selector, the electric work height adjuster and the mechanical digital dimension read-out are all conveniently placed for the operator. In the non-CE model in the standard version the worktable is raised using a handwheel.



The ground, cast-iron worktable is mounted on four recirculating ball screws driven by a chain. Standard features on the CE version include the electric adjustment: a solution offering ease-of-use, maximum precision and rapid setup.

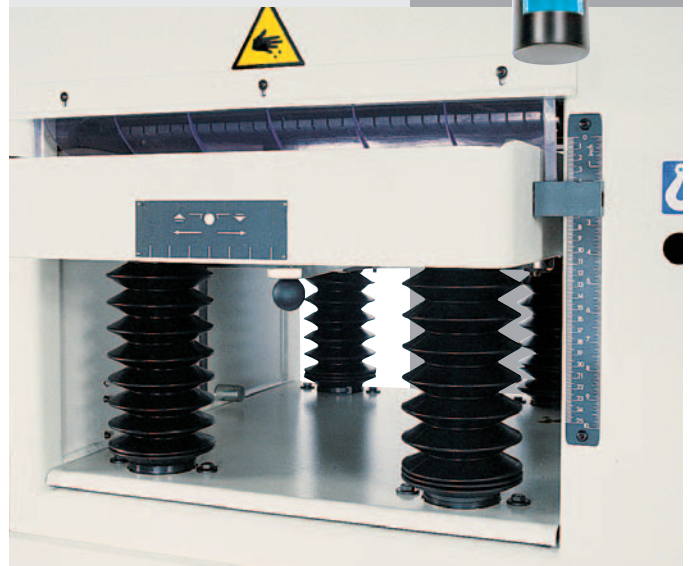

Formula **FS1 FS2** Combined planer-thicknesser machines

All advantages combined

The combined versions have the same features as the single-operation machines. Combined machines are the ideal solution for the woodworker who needs to perform a range of machining operations and has limited workshop space.



FS2 in CE configuration

Formula **FS1** **FS2**



FS1 in CE configuration

Quick and easy to retool.

Changing over from planing to thicknessing is very easy and takes just a few seconds. To make things even easier, the worktable raising system is spring-assisted.

Feed system

Both efficacy and top performances are assured. The motorized top feed rollers with large diameter, together with the rubber coated outfeed roller, grant an efficient and constant feed for every kind of wood.



Main options available on request

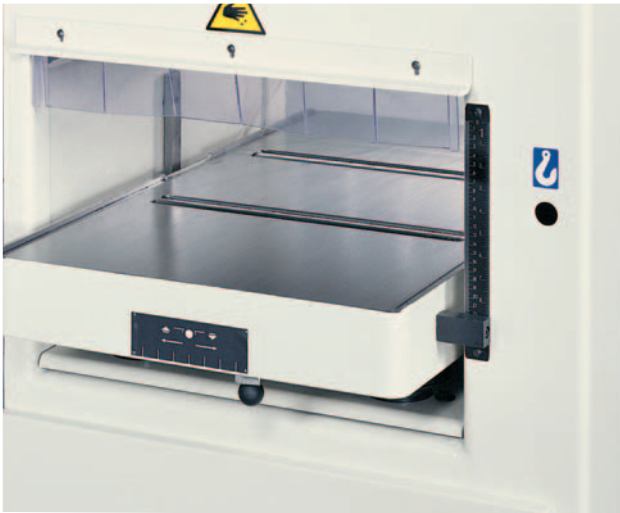

The thickener worktable can be fitted with **two rollers** to optimise workpiece feed and throughput.

Available on SP1, SP2, FS1, FS2

Mortising unit: it is equipped with a large-sized worktable with a precise horizontal, vertical and transversal movement.

Available on F1, F2, FS1, FS2

Worktable dimensions: 540x330 mm

Strokes:

X = 200 mm

Y = 165 mm

Z = 120 mm

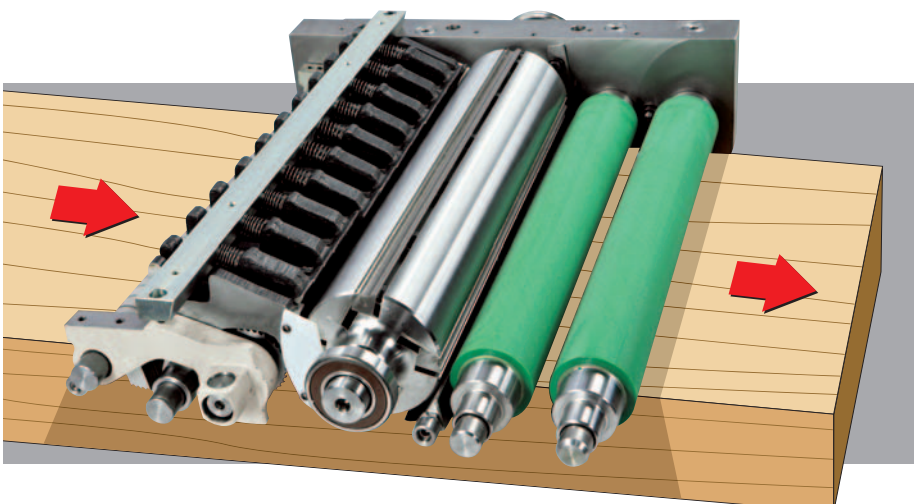

Third feed roller

This is a powered, rubber-coated roller designed to ensure perfect workpiece feed with any type of wood.

Available on SP1 and SP2

“Tersa” cutter block with disposable knives

The knives are clamped securely in place inside the cutter block by centrifugal force. This is another feature guaranteeing top safety and machining precision. The Tersa system has no clamping screws. Changing the knives is therefore very quick and easy.

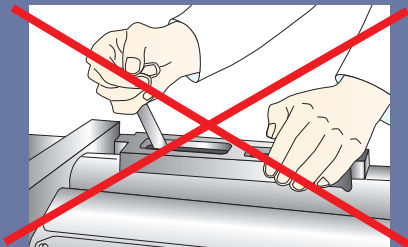

The innovative knives fixing system to the cutterblock eliminates the setting up times.

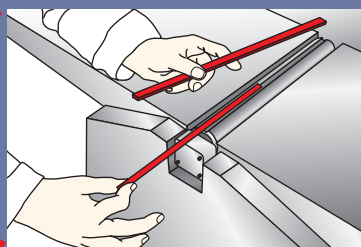

Easy cutterblock knives introduction.

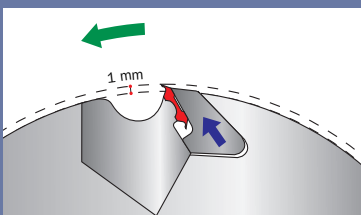

Knives self-locking at the machine starting thanks to the centrifugal force. The automatic projection of all knives is perfectly adjusted.

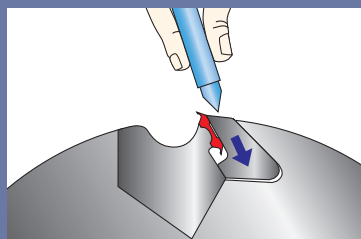

Quick knives substitution by gibs unlocking.

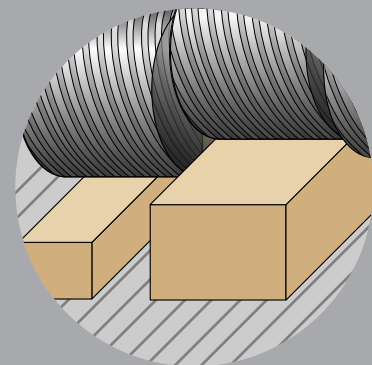
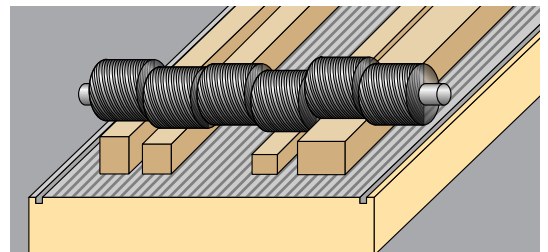

Sectioned steel roller

A feed system is available to grant the simultaneous working of different thickness workpieces. It consists of a special sectioned steel roller in place of the infeed standard one.

Available on SP1, SP2, FS2

Technical features



Surface planer		F1	F2	FS1	FS2	SP1	SP2
Working width	mm	410	520	410	520	-	-
Max. cutting depth	mm	8	8	6	6	-	-
Surface tables total length	mm	2610	2720	2070	2300	-	-
Anodised surface fence dimensions	mm	1200x190	1200x190	1200x190	1200x190	-	-
Cutterblock with 4 knives		●	●	●	●	●	●
"Tersa" cutterblock with 4 knives		○	○	○	○	○	○
Mortiser with 16 mm diameter chuck		○	○	○	○	-	-
Supplementary fence for thin workpieces		○	○	○	○	-	-
Exhaust hood diameter	mm	120	120	120	120	-	-
Thickening planer							
Working width	mm	-	-	410	520	520	630
Worktable length	mm	-	-	800	900	1000	1000
Working height	mm	-	-	240	250	250	300
Max. cutting depth	mm	-	-	7	8	8	8
Feed speed	m/min	-	-	6\12	5\8\12\18	5\8\12\18	5\8\12\18
Worktable electric lifting		-	-	○	○	● (○ - no CE)	● (○ - no CE)
Exhaust hood diameter	mm	-	-	120	120	150	150
Outfeed rubber roller		-	-	●	●	●	●
2 nd outfeed rubber roller		-	-	-	-	○	○
2 rollers on the worktable		-	-	○	○	○	○
1 st sectioned infeed roller		-	-	-	○	○	○
Electrical features							
3x400V		●	●	●	●	●	●
5,5HP (4kW) - direct start		●	●	●	-	-	-
7,5HP (5,5kW) - YD manual start		-	○	○	●	●	●
10HP (7,5kW) - YD automatic start		-	-	-	○	○	○
Automatic star-delta start		○	○	○	○	○	○

● = standard ○ = optional

F1

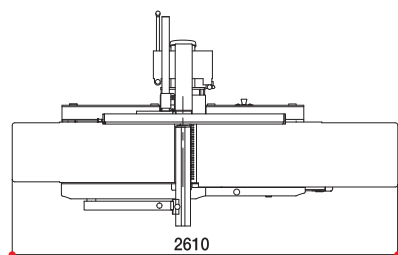

FS1

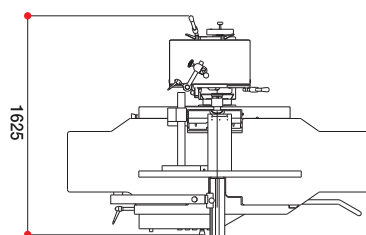

SP1

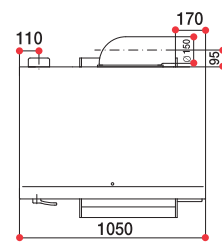

F2

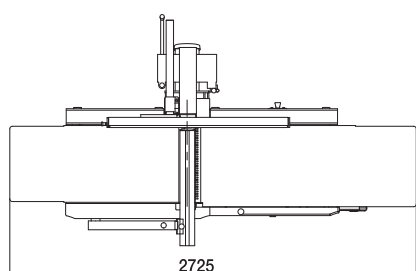

FS2

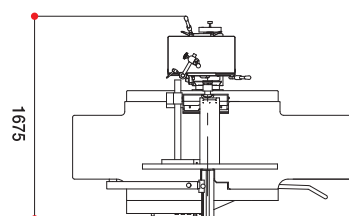

SP2

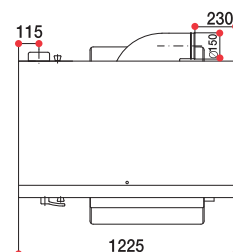

Formula **T60F** **T60I** | **T70F** Spindle moulders

Formula spindle moulders combine high performance and absolute reliability with precise, flexible operation. First-class construction approved by certification bodies and solutions resulting from the experience accumulated by an industrial group are not normally found for such a reasonable price. In addition to the standard models with fixed or tilting spindle, there are dedicated versions which offer many possibilities for working in different ways, for example for moulding or tenoning or even both on the same machine. The choice of optional items means that you can create a machine suited to specific machining requirements resulting in a highly flexible multi-purpose machine for the various requirements of woodworking shops.

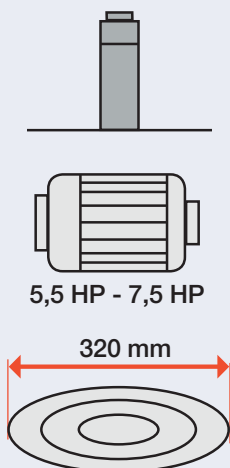

T60F

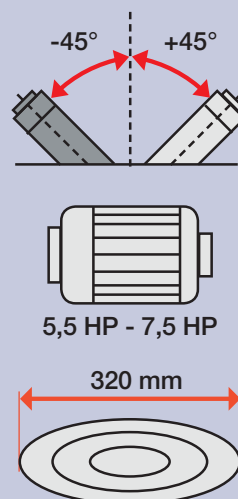

T60I

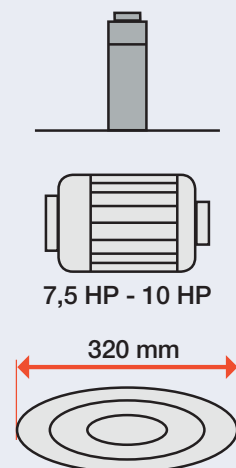

T70F

Formula **T60F T60I**

Spindle moulders with fixed or $\pm 45^\circ$ tilting spindle

The T60 is available in versions with a fixed spindle and a spindle that tilts $\pm 45^\circ$ both ways. The T60 can be used for most workshop machining requirements.

Standard motor power 5,5 HP, optional 7,5 HP



T60I "LL"
in CE configuration

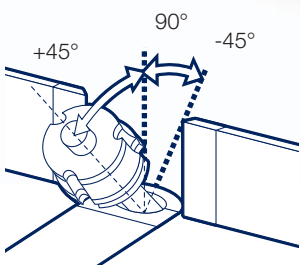

Forward and backward tilting spindle grants the maximum flexibility.

LL version

The "LL" version is available with two side table extensions and an extractable front support table, for increased safety and more precise machining of long and heavy profiles.

The cast iron tables have a ground surface to guarantee flatness.

Formula T60F T60I



T60F in CE configuration

T and TL versions

The "T" or "TL" versions meet the special requirements of door and window machining. The table extension for large workpieces ("TL" version) provides a larger supporting surface. For precision tenoning, the machine has a sliding table which runs easily on axial bearings on a hardened, ground bar. The table has a large support area and comes complete with a tilting fence that tilts $\pm 45^\circ$ and incorporates a cam lock clamping device. The tenoning version has special safety devices, such as arm guards and a dedicated hood which allows the use of tools with a diameter of up to 350 mm.



T60F "TL"
in CE configuration

Formula **T70F**

Spindle moulder with fixed spindle

The model T70 is dedicated to demanding use, both in performances and in flexibility. Thanks to the increased motor power the machine is suitable for intensive processing of large dimensions solid wood.

Standard motor power 7,5 HP, optional 10 HP



T70F "LL"
in CE configuration

Formula **T70F**



T70F in "non CE" configuration



T70F "TL"
in CE configuration
(machine with options)

Main options available on request

T60F T60I | T70F

“Fast” sectional table

Substitutes rings and allows maximum support for the workpiece being machined. The table can even be adjusted after the tools have been fitted. Applying a table segment behind the spindle used for machining guarantees very efficient extraction.

For T70F only

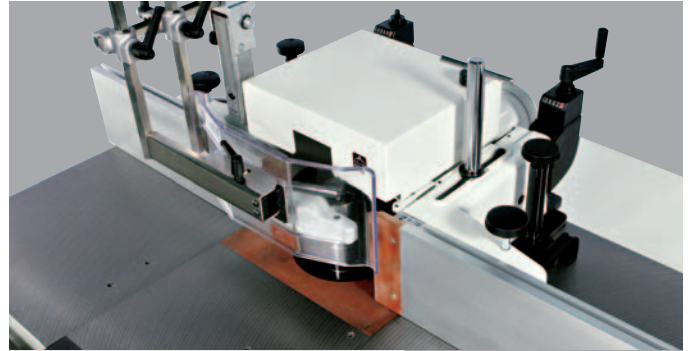
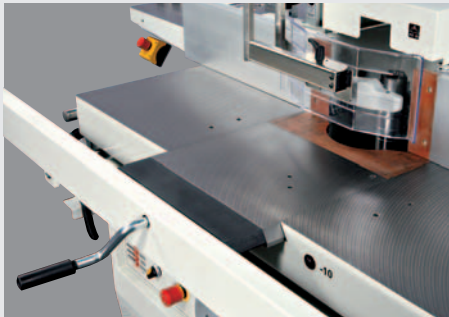

Fully adjustable spindle moulder fence. The entire fence has continuous linear adjustment by means of a single handwheel. This handwheel provides adjustment to the infeed and outfeed fence independently. Movements are displayed by mechanical digital read-outs. The side handles make it easy to remove the guide from the worktable.

For T70F only



Anodised aluminium guides with “T”-shaped upper groove for insertion of stops during interrupted machining. Complete with connecting bars for a maximum supporting surface area close to the tool.

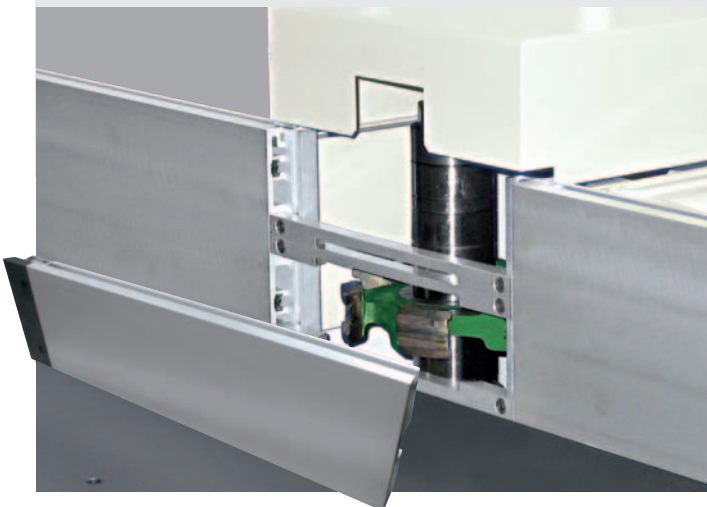

Interchangeable spindle with MK4 fitting on T60 and MK5 on T70. For using tools with different hole diameters thanks to the possibility of rapid changing of the spindle.



Spindle reverse rotation
for even more flexible use.

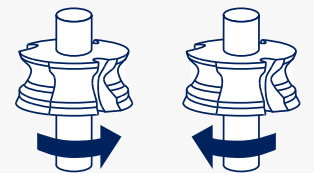

Technical specifications



		T60F	T60I	T70F
Working table dimensions	mm	1200x730	1200x810	1200x730
Working height of spindle	mm	170	180	180
Spindle tilting	degrees	-	(+45° / -45°)	-
Max. diameter of linear profiling tool	mm	250	250	250
Max. diameter of tenoning tool	mm	350	350	350
Max. diameter of moulding tool	mm	160	160	160
Spindle moulder stroke	mm	90	90	90
Spindle moulder speed	rpm	3000/4500/6000 8000/10000	3000/4500/6000 8000/10000	3000/4500/6000 7000/10000
Max. dimensions of returning tool under the table	mm	320x85	320x60	320x85
Exhaust hood on fence, diameter	mm	120	120	120
Exhaust hood behind the base, diameter	mm	120	2x60	120
Base machine weight	kg	490	560	525
Options				
Carriage on fixed table for small tenoning operations		○	○	○
Version "LL" for profiling operations		○	○	○
Version "T" for tenoning operations (lateral carriage)		○	○	○
Version "TL" for tenoning and profiling operations		○	○	○
"Fast" section table		-	-	○
Spindle moulder fence with adjustment by crank		-	-	○
Anodized aluminum fence plates for spindle moulder fence		○	○	○
Interchangeable spindle		○	○	○
Reverse spindle rotation		○	○	○
Electrical features				
3x400V		●	●	●
5,5HP (4kW) direct start		●	●	-
7,5HP (5,5kW) YD manual start (direct start USA/CANADA)		○	○	●
10HP (7,5kW) YD automatic start (direct start USA/CANADA)		-	-	○

● = standard ○ = optional

T60F - T70F

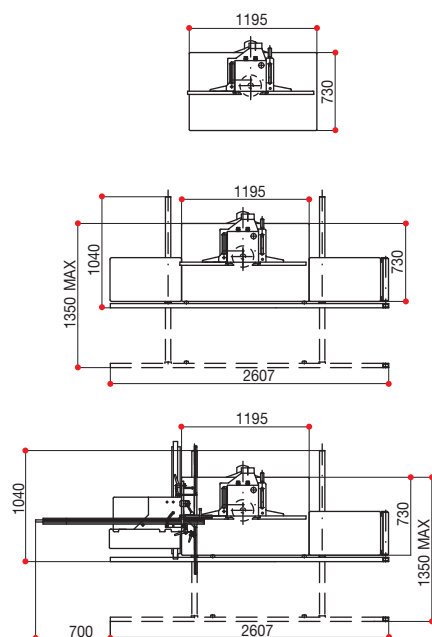

T60I

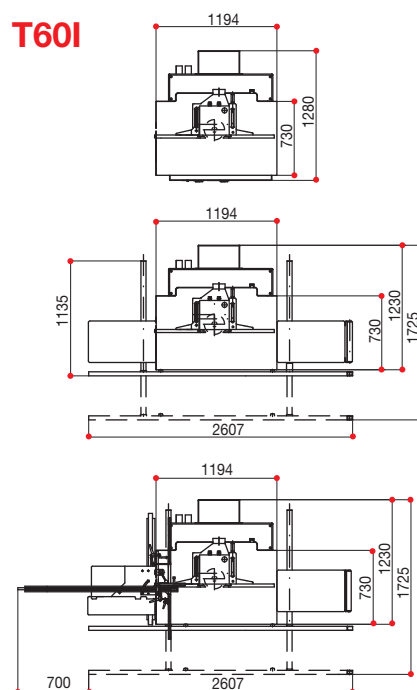

FORMULA

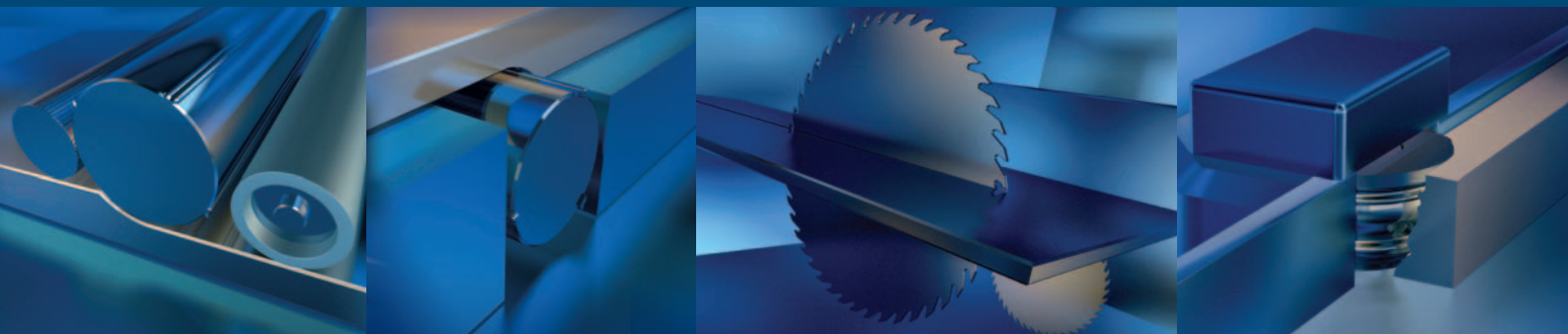

SCM GROUP spa - FORMULA

Via Casale, 450

47826 Villa Verucchio (RN) - Italy

Tel. +39/0541/679578 - Fax +39/0541/674273

www.scmgroup.com - serviceformula@scmgroup.com