







TRIMWEX

WOODWORKING MACHINERY



-  Machine designation
-  Programmübersicht
-  Désignation des machines
-  Programma prodotti
-  Programma de production
-  Произвдственная програама

Clamp carrier
Verleimstern
Encolleuse en étoile
Strettoio incollaggio listelli
Estrella Encoladore de tablas
Звезда склеивания



Model SL - H

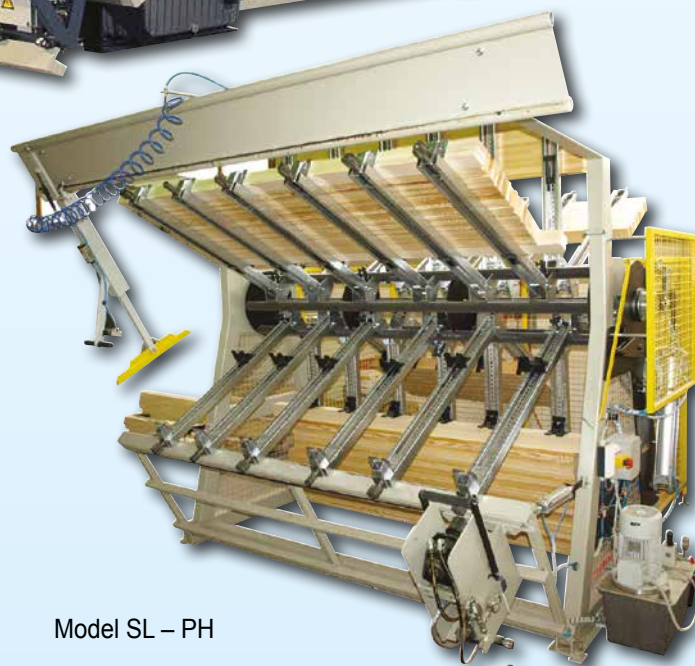

Model SL - PH



Model SLA - H

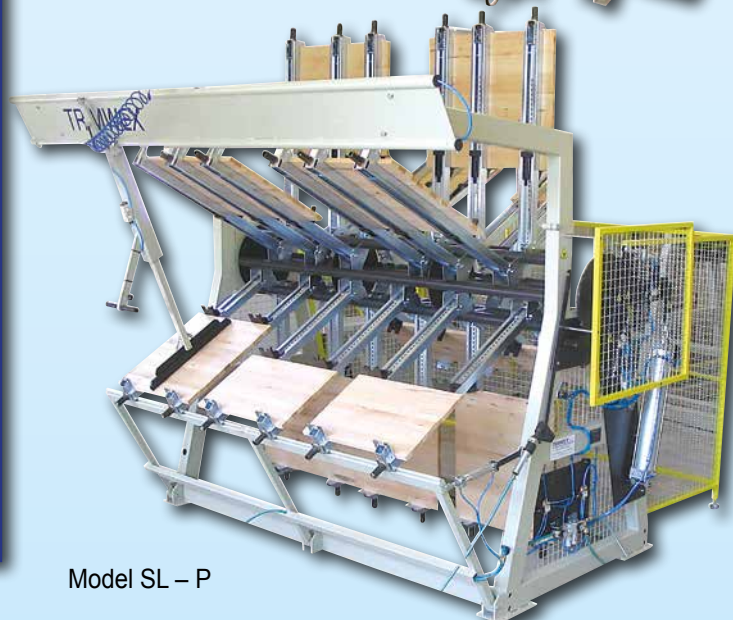

Model SL - P

Hydraulic press for width / thickness based panel bonding
Hydraulikpresse für Breiten-/Dickenholzverleimung von Platten
Presse hydraulique pour le collage de plaques dans la largeur/épaisseur
Pressa idraulica per incollamento di pannelli trasversale/a spessore
Prensa hidráulica para unir madera en espesor
Гидравлический пресс для клейки элементов по ширине / толщине

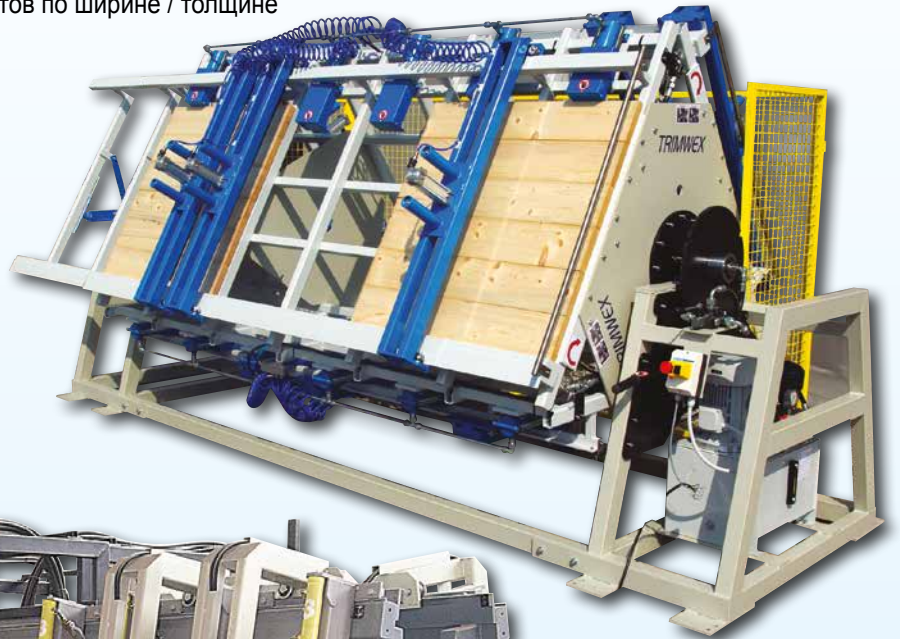

Model SL - HPR3



Model SLV - HB



Press for lamination of wooden stock
Blockverleimpresse
Presses simple a collar
Strettoio incollaggio lamellare
Prensas para vigas laminadas
Пресс для склеивания по толщине



Hydraulic presses for laminated beams
Hydraulische Pressen für Lamellierte Balken
La presse pour les putres collées
Strettoio idraulici per travi lamellari
Prensas para vigas laminadas
Гидравлический пресс для склеивания несущих баллок

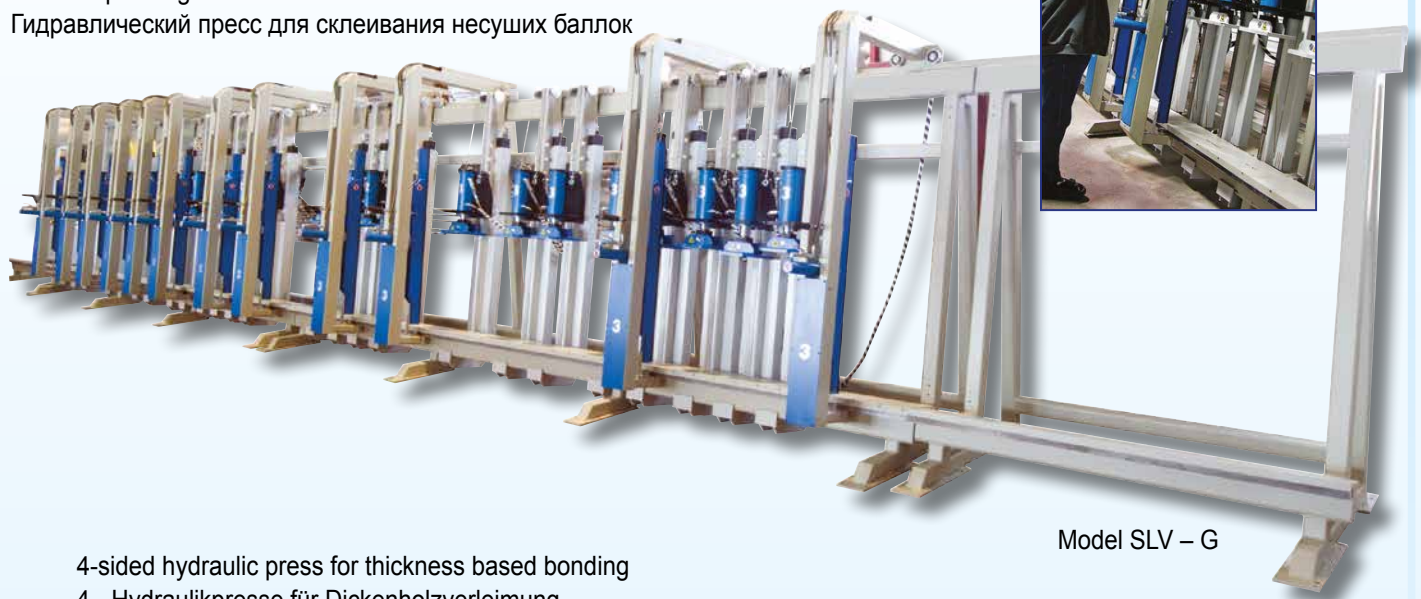

Model SLV – G

4-sided hydraulic press for thickness based bonding
4 - Hydraulikpresse für Dickenholzverleimung
4 presses hydrauliques latérales pour le collage dans l'épaisseur
Pressa idraulica per incollamento a spessore a 4 lati
Prensa hidraulica cuadrangular para unir maderas
4-сторонний гидравлический пресс для склеивания по толщине



Model ROTOR

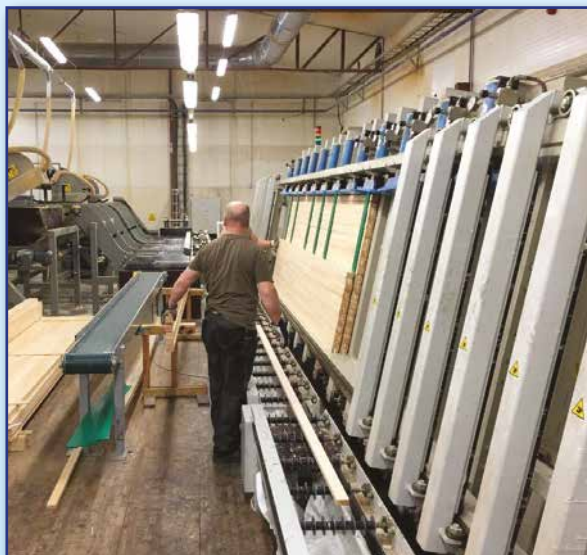



Model PRIMO

Frame press
 Rahmenpresse
 Presse pour l'assemblage les plinthes
 Impianto di pressatura per l'incollaggio delle cornici
 Prensa para pegar los marcos
 Тиски для склеивания рамок



Assembly press
 Montagepresse
 Presse d'assemblage
 Strettoio
 Prensas para montaje
 Пресс для сборки мебели

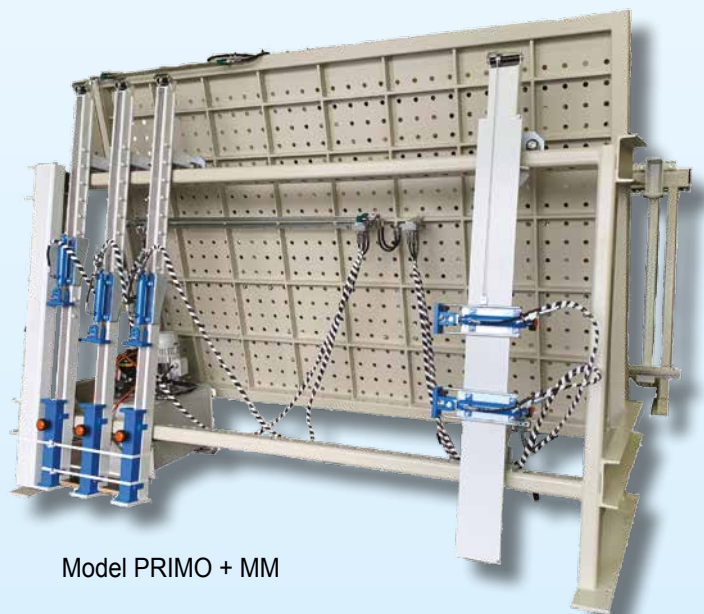

Model PRIMO + MM



Model MULTIPRESS

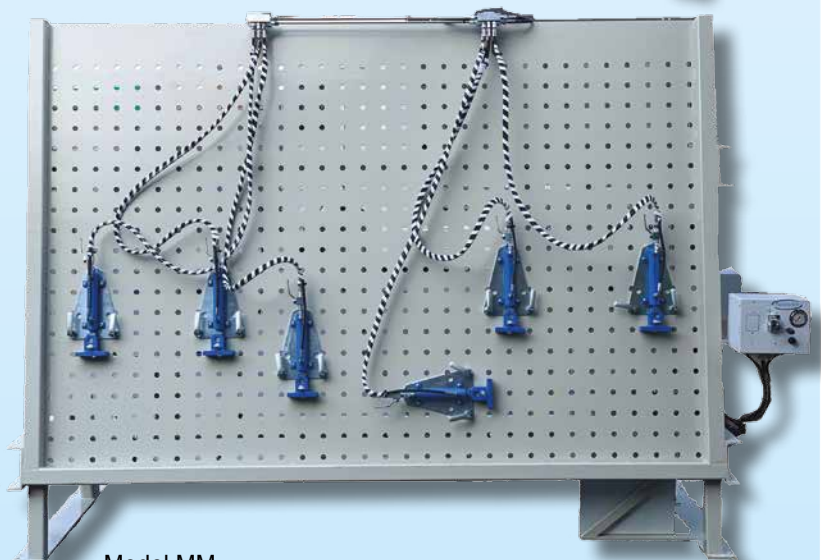

Model MM

Press for gluing of beams
Leimbinderpresse
La presse pour les putres collées
Strettoio per la produzione di travi
Prensas para vigas laminadas
Гидравлический пресс для склеивания несущих балок

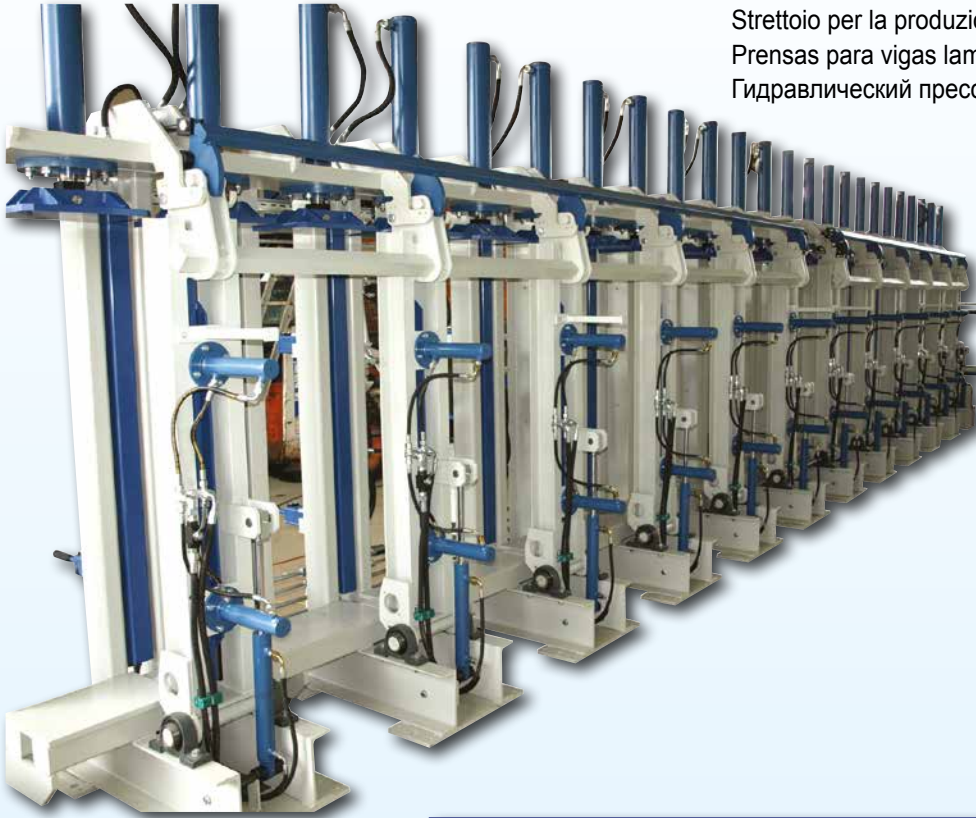

Model GIGA



Model LN

Glue spreader
Leimauftragmaschine
Encolleuse
Spalmatrice di colla
Encoladora
Клеенамазочная машина



Model GST



Model GZT

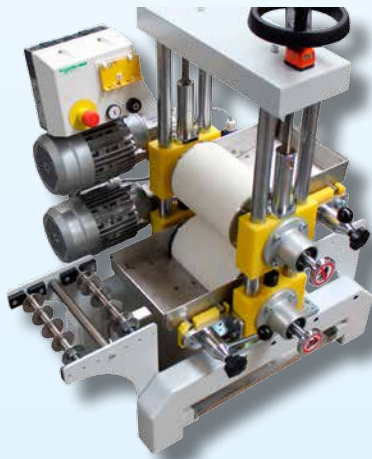

Model GDT



Model LA - D



LA - Z/D



Model TRIMWEXPUR

Gluing line
Leimauftraganlage
L'installation à encoller
Linea di incollaggio
Linea de encloladora
Клеенамазочная машина

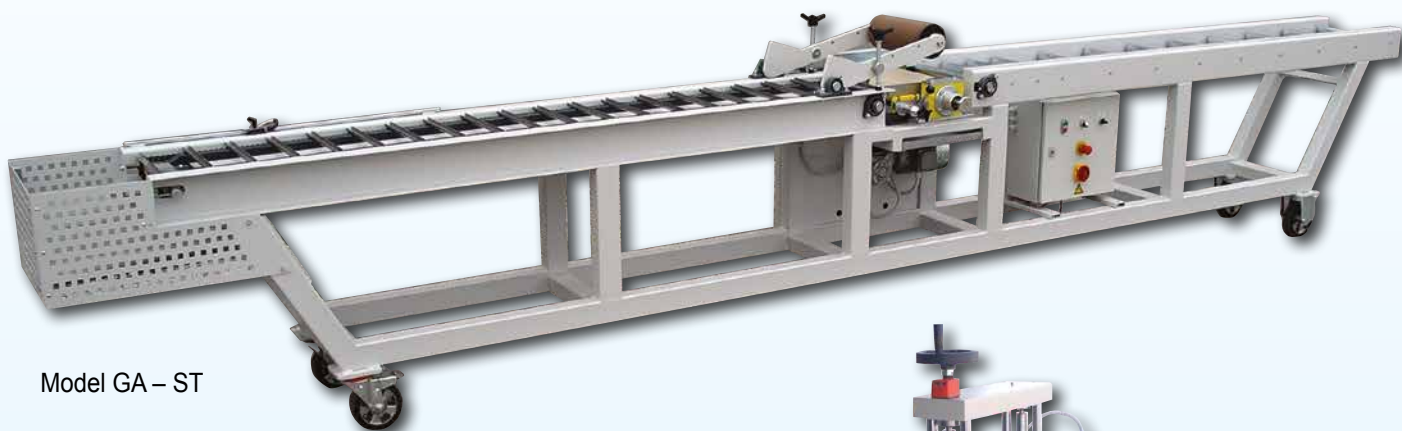

Model GA - ST



Model GA - DT

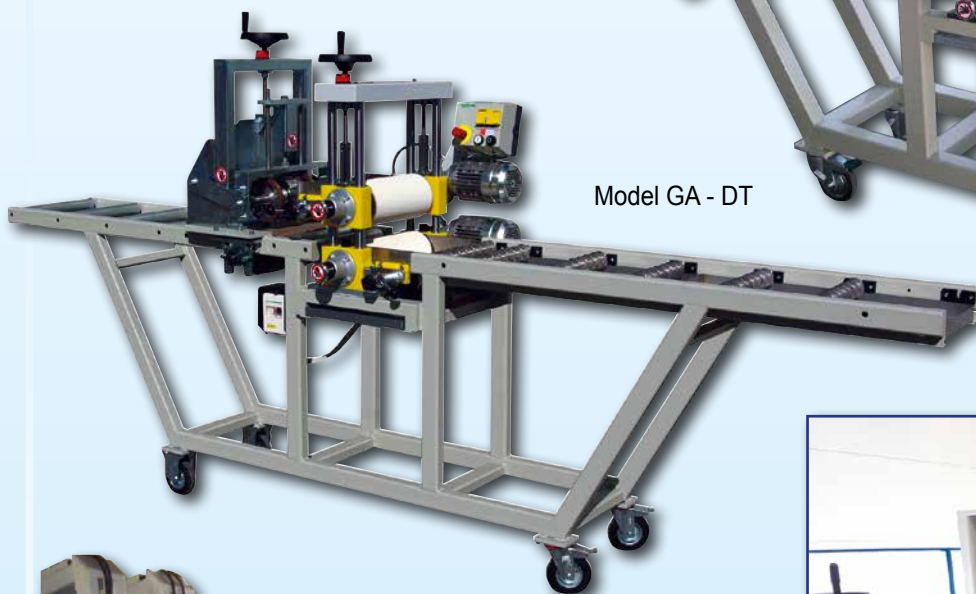

Model GA - DT - MAG



Model SLV – G – T



Hydraulic press for parquet
Hydraulikpresse für Parkett
Presse hydraulique pour le parquet
Pressa idraulica per parquet
Prensa hidraulica para parqués
Гидравлический пресс для паркета

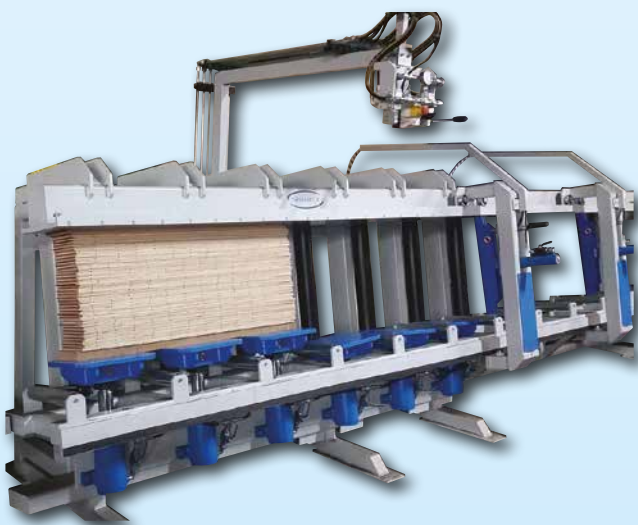

Side rotor for parquet lamelas
Seitigenrotor für den Parkettlamellen
Rotor latéral pour l'assemblage des lames de parquet
Rotore laterale per l'incollaggio delle lamelle del parquet
Rotor lateral para pegar las lamelas de parquet
Боковой ротор для склеивания паркетных ламелей

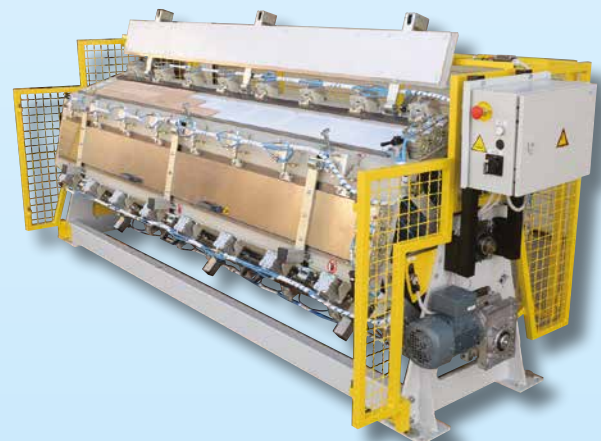

MTM-HA

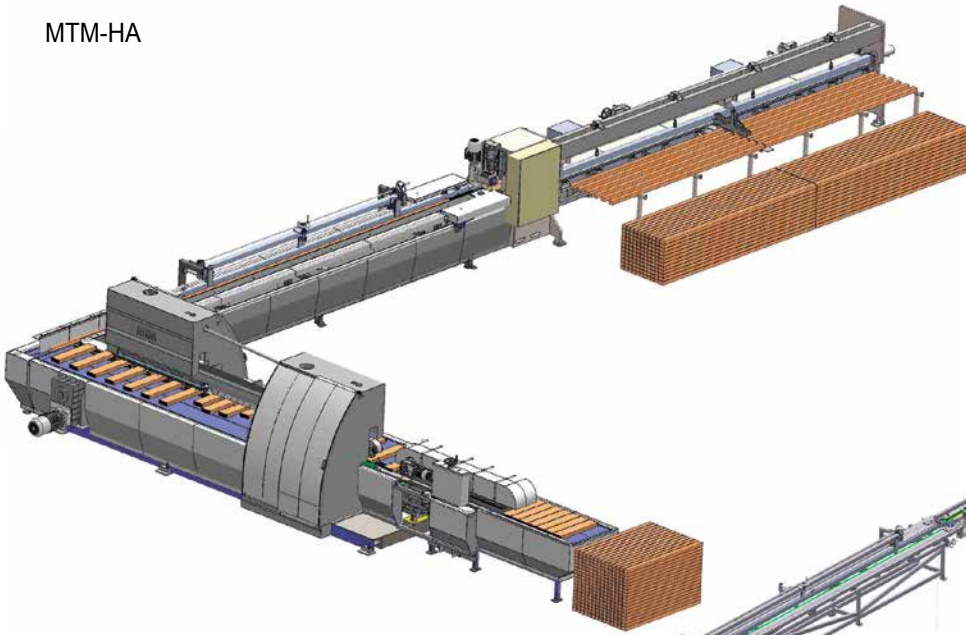

Finger jointing lines
 Keilzinkenanlagen
 Lignes pour aboutage de tête
 Linee per giunzione a pettine
 Lineas de empalme
 Линия сращивания по длине

MTM-H

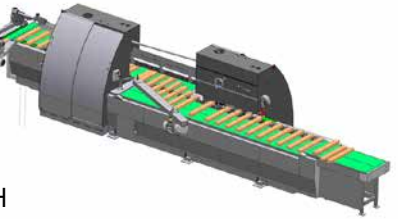

MTM-C-AA

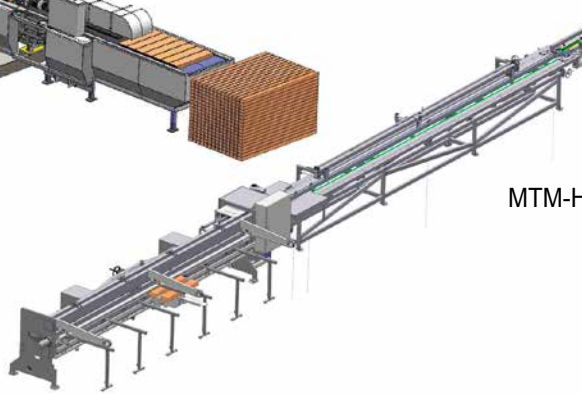
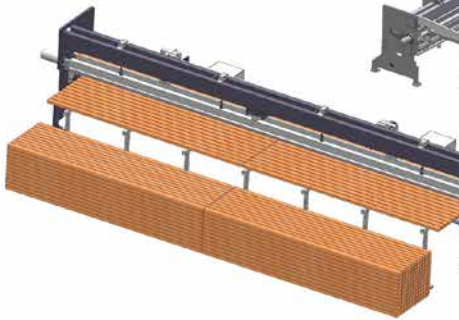

MTM-C-HS

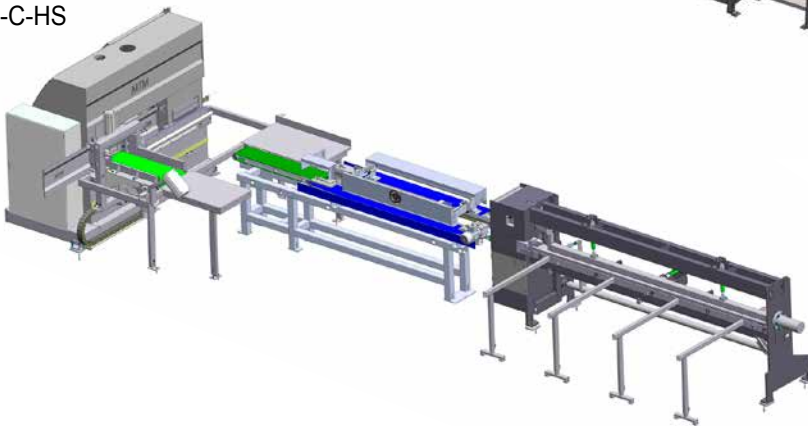

MTM-V-HA

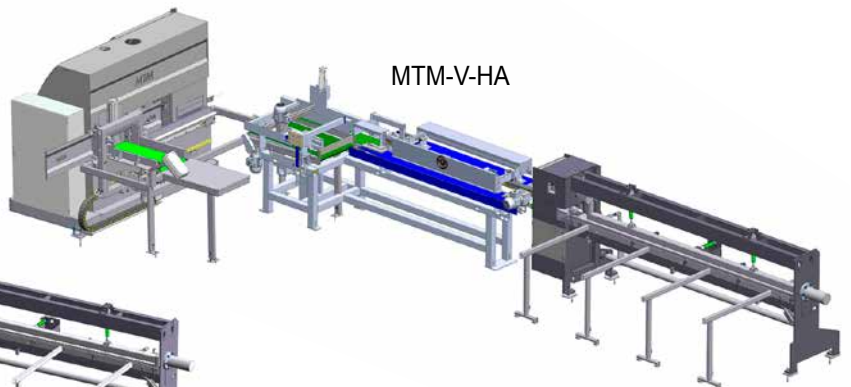

MTM-V-HH



Roller coater
Dosierwalzmaschine
Applicateur d'huile
Impianto per l'applicazione dell'olio
Aplicador de aceite
Устройство для нанесения масла

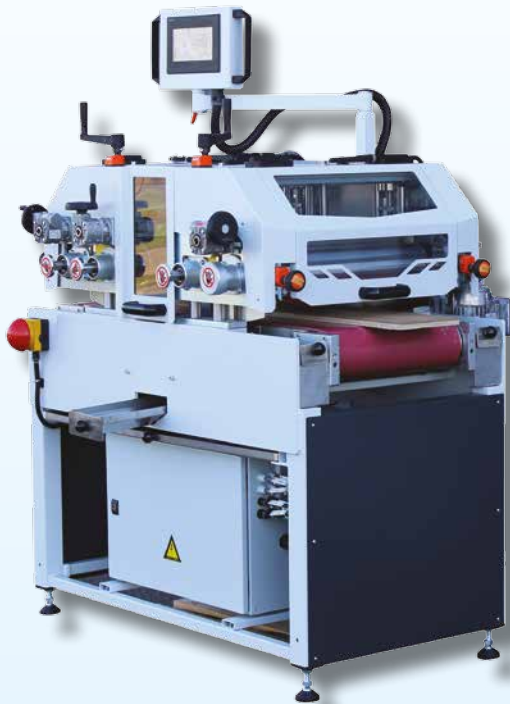

TRV – XP



AIO450

TRIMWEX 

Pot k skakalnici 9A
1210 LJUBLJANA - ŠENTVID
SLOVENIJA

tel.: +386 1 512 93 60
GSM: +386 31 364 779
E-mail: info@trimwex.si
www.trimwex.si

