

# CNC-Processing Center

## Venture 3

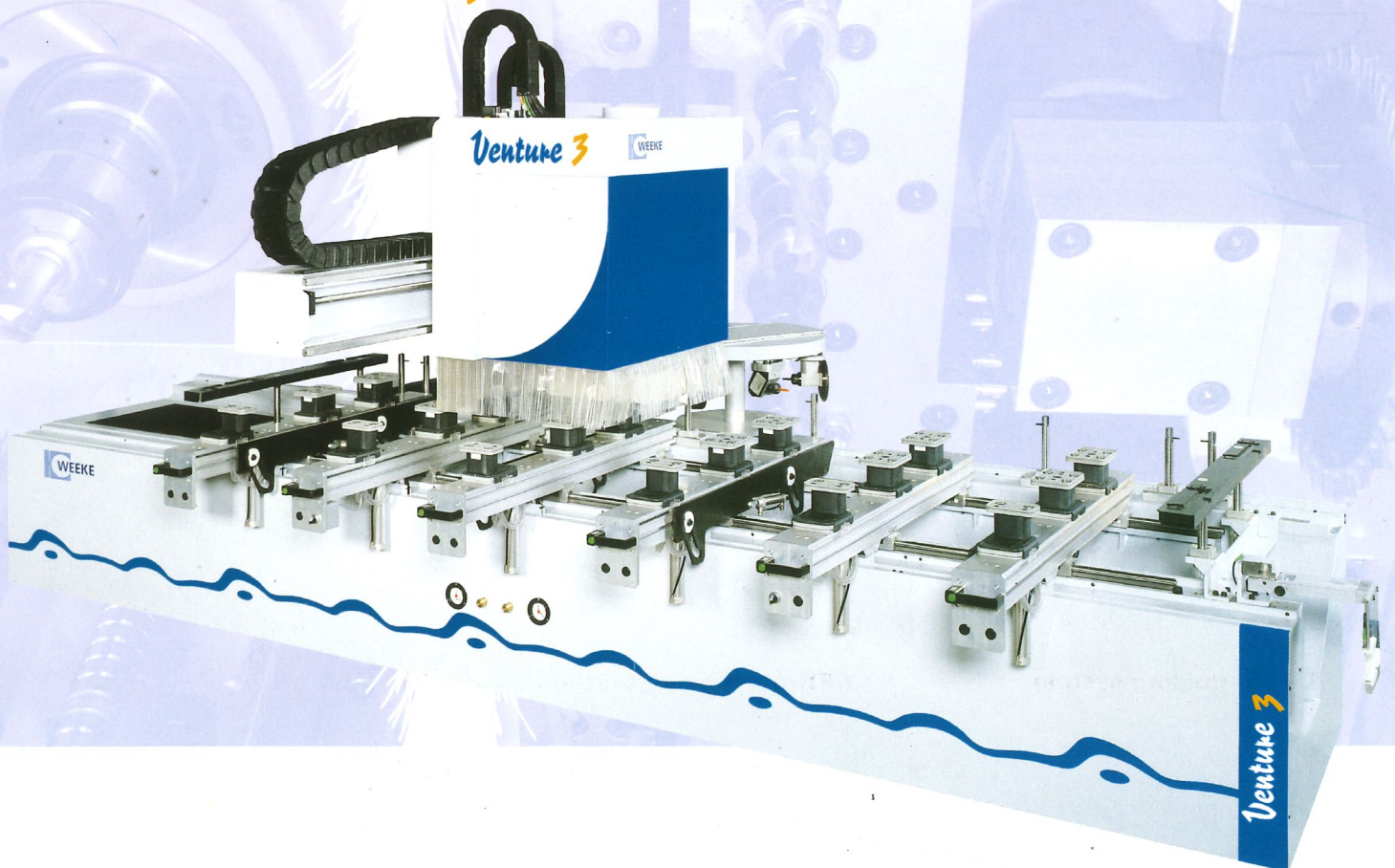

2005



# Venture 3

**Working field:**  
3250 x 1250 x 125 mm

**Highlights:**

- Shorter processing times by a traverse speed in X-direction of up to 100 m/min
- Time saving and secure positioning of the workpiece consoles and the vacuum cups via LED-system
- Integrated C-axis
- Even under heaviest processing the heavy steel ribs within the frame absorb any resonance and frame flexing
- Powerful 9 kW HSK routing spindle
- 2 Z-axes
- Processing is possible up to a workpiece thickness of 125 mm
- Routing dimension in Y-direction to max. 1378 mm
- 14 tool changing places
- UPS „uninterrupted power supply“ - protects the computer against damages in case of mains interruption. In such a case the computer is powered down to avoid loss of data.

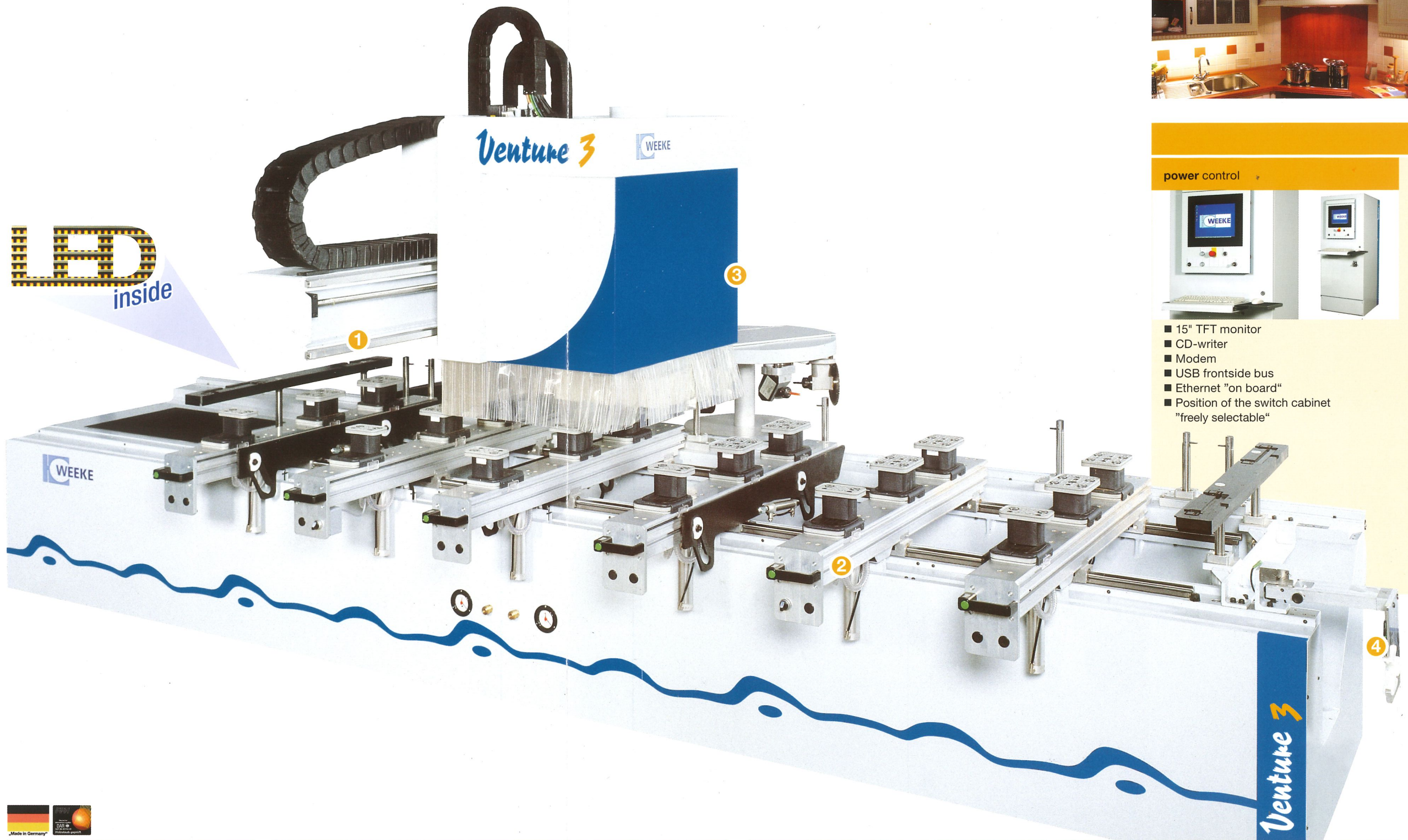

**power control**



- 15" TFT monitor
- CD-writer
- Modem
- USB frontside bus
- Ethernet "on board"
- Position of the switch cabinet "freely selectable"



**1 Linear guiding system**



Sealed "long-life" linear guiding system

**2 LED-positioning system**

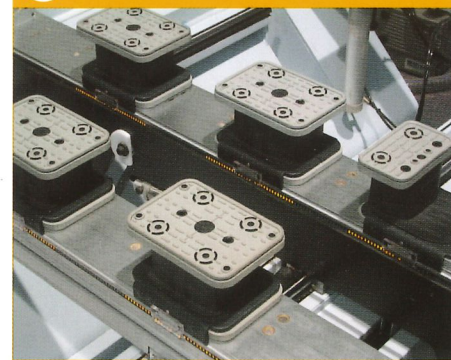

The LED-lights display the correct position of the cups to the operator. Up to 70 % faster positioning.

**2 Z-axes**

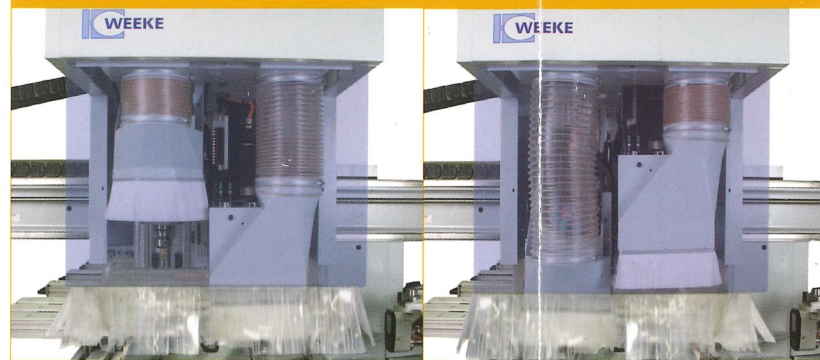

■ Optimal dust extraction and bigger operative range for processing tools

**3 Configuration**

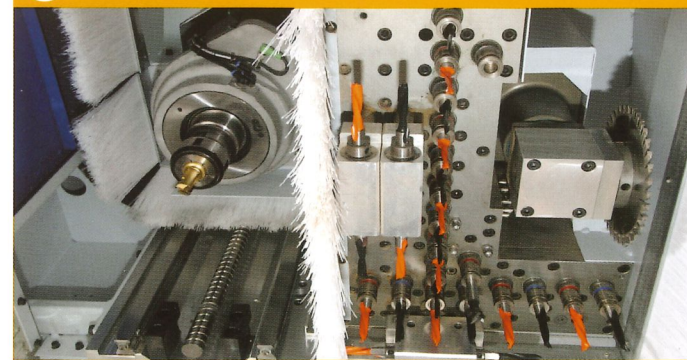

■ 19 vertical drilling spindles ■ 6 horizontal drilling spindles  
 ■ 1 routing spindle with 9 kW ■ 1 C-axis with HSK F 63  
 ■ 1 grooving saw (Ø 125 mm / 90°)

**4 Tool pick-up station**

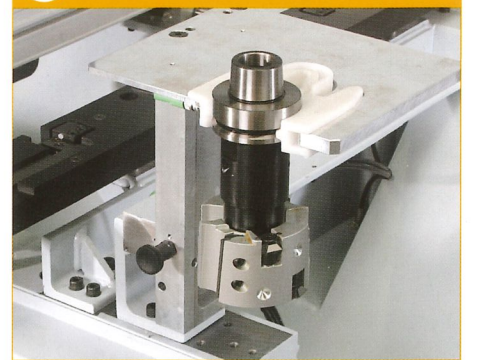

Secure and quick fitting of the tool changer

Pictures may also show options

## Options

# Venture 3

### Air-conditioning

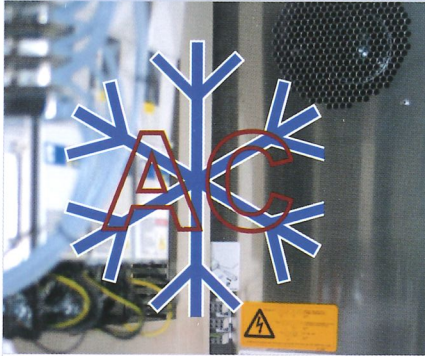

Air-conditioned cabinet

### Multi-clamping system

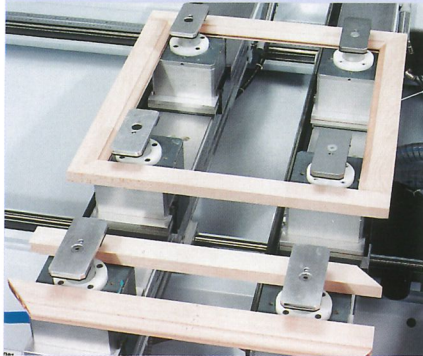

E.g. for frame and narrow parts

### Software



■ DXF-postprocessor ■ Barcode software

Pictures may also show options

## Adapter aggregates

### Drilling/Routing/ Sawing, 2 spindles



1603

### Routing, 2 spindles



1610

### Routing, 4 spindles



1605

### Drilling/Sawing, man. inclinable – (0° - 90°)



1515

### Drilling/Routing, man. inclinable – (0° - 45°)



1613

### Cam box router, Ø 16 mm, 2 spindles



1626

### Routing vertical with tracing bell



1650

### Corner notching

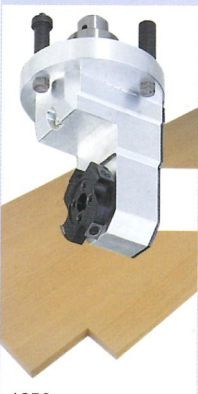

1656

### Drilling, 7 spindles – 25 mm pitch

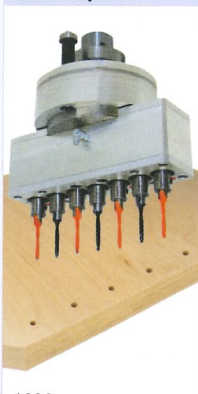

1680

### Fitting drilling head, 3 spindles



1695

## Contact us!

- Teleservice possibility via basic-modem-connection
- Competent spare parts service
- Weeke communication: up-to-date information at all times:  
[www.weeke.com](http://www.weeke.com)
- Any questions, new ideas, criticism & praise to:  
[info@weeke.de](mailto:info@weeke.de)



## All inclusive – "Standards"

### High-Speed spindles



1500 - 7500 RPM including patented quick change system

### Automatic spindle locking system

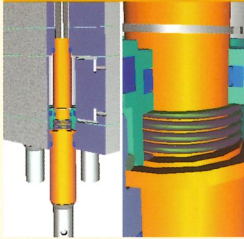

Patented system for exact drilling depth at any time with different materials

### Workpiece feeding rail

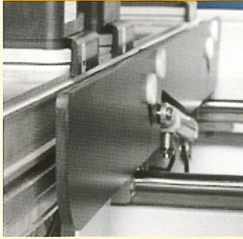

4 solid feeding rails to ease "sheeting" of heavy workpieces

### UPS

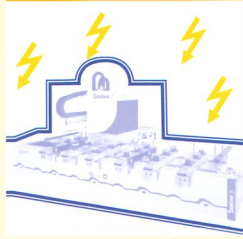

Protects the computer against damages in case of mains interruption

### Tool changer



14-fold tool changer in X-direction

### Vacuum cups

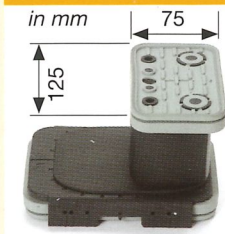

6 narrow vacuum cups

### Vacuum cups



12 standard vacuum cups

### Tilting stops for laminate overhang



Guarantee simple positioning of panels with laminate overhang

### Sealed energy cable



Secure and protected cable guide

### Tool kit



Top equipment - from the very start

## Software

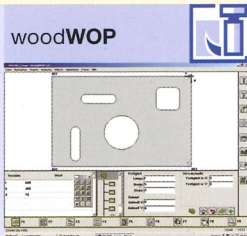

- Modern software based on Windows®
- More than 10.000 installations worldwide



- Simple 3D construction of furniture including a parts list output and export of cutting lists



- Simulates the processing in the order it is stored in the NC-program
- Allows time calculation
- Collision check of the vacuum cups

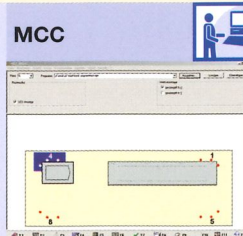

- Modern and simple control of main machine functions through soft keys
- Graphical loading
- Optimized space

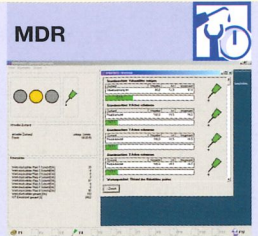

- Machine Data Recording - collecting and evaluating machine states via time meter and event meter

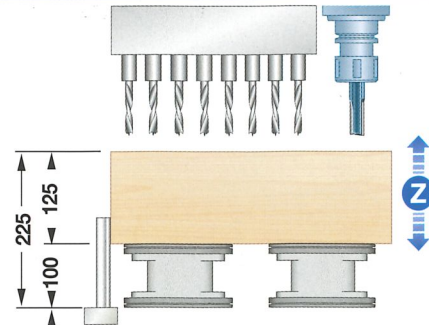
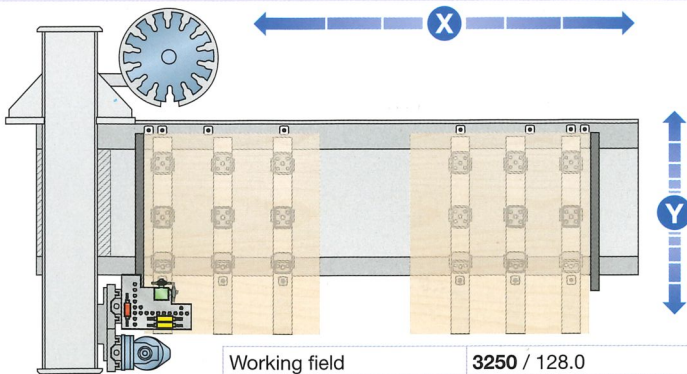

Working field	3250 / 128.0	1250 / 49.2	125* / 4.9
Travel range	3860 / 152.0	1793 / 70.6	185** / 7.3 (300*** / 11.8)
Routing	3595 / 141.5	1378 / 54.3	125* / 4.9
Alternating operation	1450 / 57.0		
Two-field operation	1100 / 43.3	mm / inch	

\*considering the utility of the corresponding tool lengths | \*\*drilling | \*\*\*routing

# Venture 3

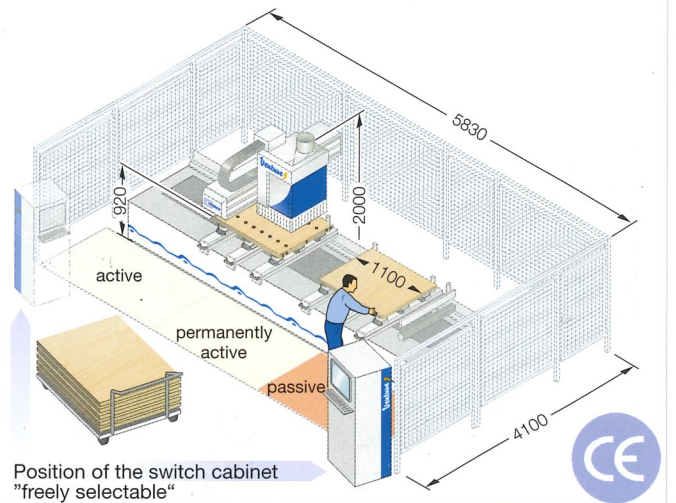
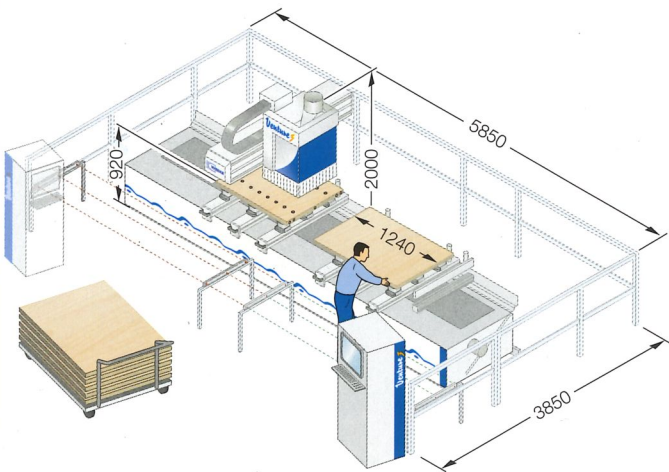
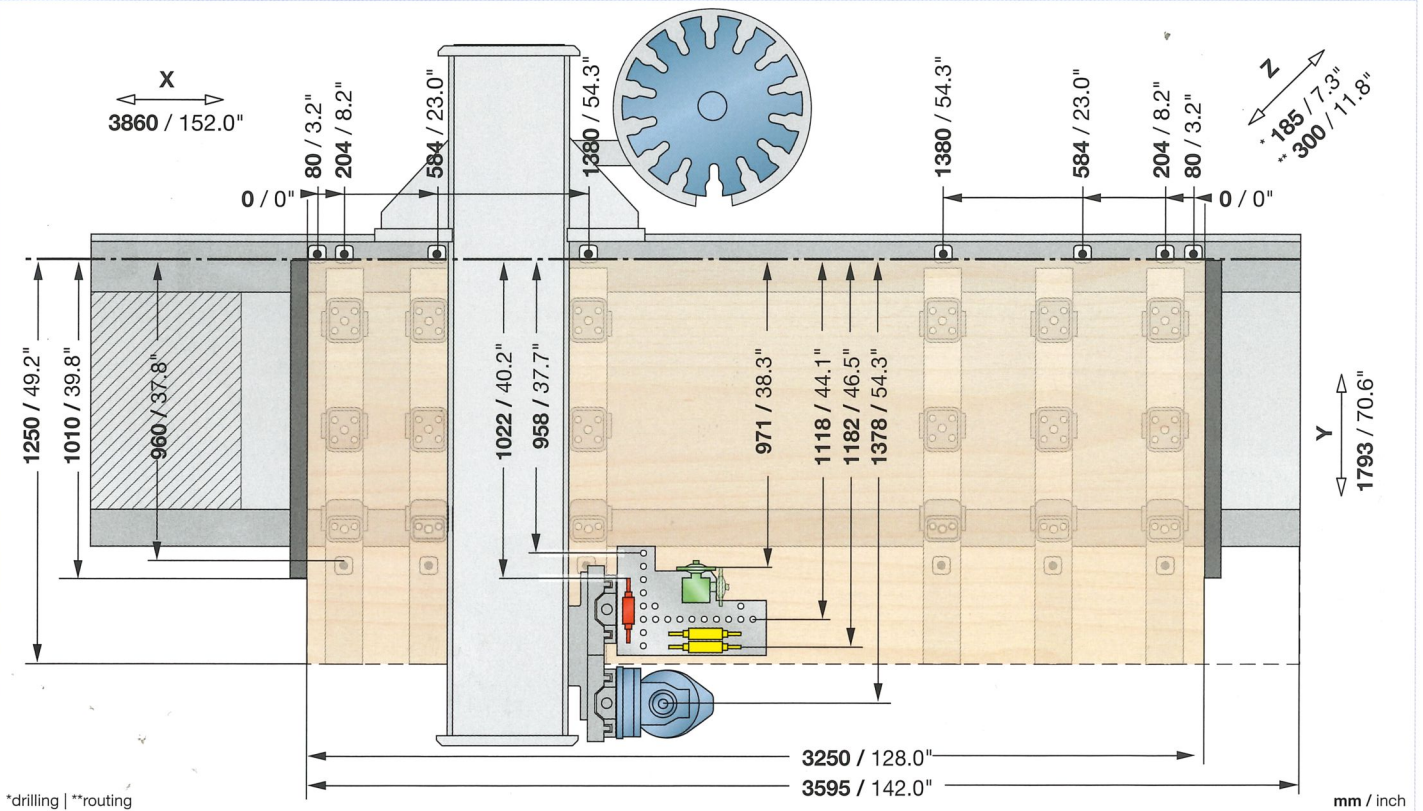

## TECHNICAL DATA

Travel range X - Y - Z-axis	mm	3860-1793-185*/300**
Rapid traverse speed X - Y - Z-axis	m/min	100 - 50 - 20
Compressed air connection	inch	R ½
Compressed air required	bar	7
Dust extraction port	mm	Ø 200
Dust extraction volume	m³/h	min. 3170
Total machine weight	kg	appr. 4300
Electrical power - total connection load	kW	17.5
Switch cabinet L - W - H	mm	800 - 800 - 1970



## WEEKE Bohrsysteme GmbH

Benzstraße 10-16  
33442 HERZEBROCK-CLARHOLZ  
GERMANY  
Phone: +49 5245 445-0  
Fax: +49 5245 445-139  
info@weeke.de - www.weeke.com